

---

**1989**

---

**BMW M3**

---

**Electrical**

---

**Troubleshooting**

---

**Manual**

---

BMW of North America, Inc.  
Woodcliff Lake, New Jersey

## **FOREWORD**

In the interests of continuing technical development work we reserve the right to modify designs and equipment.

Printed in USA

©Copyright BMW of North America, Inc.

Not to be reproduced wholly or in part  
without written permission of BMW of  
North America, Inc.

**PN 89 89 1 000 295**

**1989  
BMW M3  
Electrical  
Troubleshooting  
Manual**

**CONTENTS**

---

Index . . . . .	2
How To Use This Manual . . . . .	3
Wire Size Conversion Chart . . . . .	3
Symbols . . . . .	4
Systematic Troubleshooting . . . . .	6
Connector Views . . . . .	8500-0
Power Distribution Box . . . . .	0670-0
Fuse Data . . . . .	0670-1
Component Location Chart . . . . .	9000-0
Component Location Views . . . . .	7000-0
Splice Location Views . . . . .	8000-0

---

## Index — Alphabetical Listing of Electrical Circuits

	PAGE		PAGE		PAGE
Active Check Control . . . . .	6216-0	— G201 . . . . .	0670-14	— Headlights . . . . .	6312-0
A/C Air Delivery Control . . . . .	6421-0	— G300 . . . . .	0670-15	— Instrument Cluster . . . . .	6300-1
A/C Blower Controls . . . . .	6413-0	Horns . . . . .	6100-0	— Interior . . . . .	6330-0
A/C Compressor Controls . . . . .	6452-0	Ignition Key Warning . . . . .	6131-0	— License . . . . .	6320-0
A/C Temperature Control . . . . .	6411-0	Indicators		— Map Reading Light . . . . .	6100-1
Antilock Brake . . . . .	3450-0	— ABS . . . . .	3450-0	— Rear Ashtray . . . . .	6300-1
Auto-Charging Flashlight . . . . .	6100-1	— Active Check Control Alarm . . . . .	6216-1	— Rear Side Marker . . . . .	6320-0
Auxiliary Fan . . . . .	6454-0	— "Brake Lights" Fault . . . . .	6216-1	— Stop . . . . .	6325-0
Auxiliary Fuse . . . . .	0670-2	— "Brake Lining" Wear . . . . .	3435-0	— Tail . . . . .	6314-0
Brake Warning System . . . . .	3435-0	— "Brake Warning" . . . . .	3435-0	— Trunk . . . . .	6320-0
Central Locking . . . . .	5126-0	— Charge . . . . .	6210-0	— Turn/Park . . . . .	6313-1
Charge System . . . . .	1230-0	— "Coolant" Level Fault . . . . .	6216-2	Light Switch Details . . . . .	6300-0
Cigar Lighter . . . . .	6100-1	— "Engine Oil" Fault . . . . .	6216-2	On-Board Computer . . . . .	6581-0
Component Location Chart . . . . .	9000-0	— Fasten Seatbelts . . . . .	6216-2	Power Distribution . . . . .	0670-0
Component Location Views . . . . .	7000-0	— Fog Lights . . . . .	6312-0	Power Distribution Box . . . . .	0670-0
Connector Views . . . . .	8500-0	— High Beam . . . . .	6210-0	Power Mirrors . . . . .	5116-0
Cruise Control . . . . .	6571-0	— Inspection . . . . .	6210-1	Power Windows . . . . .	5133-0
Fuel Gauge . . . . .	6210-2	— LH Turn . . . . .	6210-0	Radio . . . . .	6500-0
Fuse Data Chart . . . . .	0670-1	— "License Plate" Fault . . . . .	6216-1	Rear Defogger . . . . .	6100-2
Fuse Details		— "Low Beam" Fault . . . . .	6216-0	Seatbelt Warning . . . . .	6131-0
— Fuse 4 . . . . .	0670-6	— Low Fuel Warning . . . . .	6210-2	Service Interval Indicator . . . . .	6210-1
— Fuse 5 . . . . .	0670-6	— Oil Pressure Warning . . . . .	6210-4	Speedometer . . . . .	6210-0
— Fuse 6 . . . . .	0670-6	— Oil Service . . . . .	6210-1	Splice Location Views Index . . . . .	8000-0
— Fuse 8 . . . . .	0670-7	— "Park Brake" . . . . .	3435-0	Start . . . . .	1240-0
— Fuse 9 . . . . .	0670-11	— "Rear Lights" Fault . . . . .	6216-1	Sunroof . . . . .	5413-0
— Fuse 10 . . . . .	0670-8	— RH Turn . . . . .	6210-0	Tachometer . . . . .	6210-3
— Fuse 12 . . . . .	0670-7	— "Washer Fluid" Fault . . . . .	6216-2	Temperature Gauge . . . . .	6210-2
— Fuse 19 . . . . .	0670-7	Injection Electronics S14 Engine . . . . .	1364-0	Warnings	
— Fuse 20 . . . . .	0670-9	Instrument Cluster . . . . .	6210-0	— Ignition Key/Seatbelt . . . . .	6131-0
— Fuse 21 . . . . .	0670-10	Lights		Wiper/Washer . . . . .	6160-0
— Fuse 27 . . . . .	0670-11	— A/C Control Power . . . . .	6300-1		
Gauges . . . . .	6210-2	— Backup . . . . .	6322-0		
Ground Distribution		— Cigar Lighter . . . . .	6300-1		
— G103 . . . . .	0670-12	— Fog . . . . .	6312-0		
— G104 . . . . .	0670-13	— Front Ashtray . . . . .	6300-1		
— G106 . . . . .	0670-13	— Front Side Marker . . . . .	6314-0		
— G200 . . . . .	0670-13	— Front Turn/Park . . . . .	6314-0		
	0670-14	— Glove Box . . . . .	6100-1		
	0670-15	— Hazard Switch . . . . .	6313-0		

The purpose of this manual is to show electrical schematics in a manner that makes electrical troubleshooting easier. Electrical components which work together are shown together on one schematic. The Wiper-Washer schematic, for example, shows all of the electrical components in one diagram. At the top of the page is the fuse (positive) that powers the circuit. The flow of current is shown through all wires, connectors, switches, and motors to ground (negative) at the bottom of the page.

Within the schematic, all switches and sensors are shown "at rest," as though the Ignition Switch were off. For identification, component names are underlined and placed next to or above each component. Notes are included, describing how switches and other components work.

The power distribution schematic shows the current feed through all the connections from the Battery and Alternator to each fuse and the Ignition and Light Switches. If the Power Distribution schematic is combined with any other circuit schematic, a complete picture is made of how that circuit works. The Ground Distribution schematics show how several circuits are connected to common grounds.

All wiring between components is shown exactly as it exists in the vehicle; however, the wiring is not drawn to scale. To aid in understanding electrical operation, wiring inside complicated components has been simplified. The "Solid State" label designates electronic components.

WIRE SIZE CONVERSION CHART	
METRIC (CROSSECTIONAL AREA IN MM <sup>2</sup> )	AWG (AMERICAN WIRE GAUGE)
.5	20
.75	18
1	16
1.5	14
2	14
2.5	12
4	10
6	8
8	8
16	4
20	4
25	2
32	2

WIRE INSULATION	
ABBREVIATIONS	COLOR
BK	BLACK
BR	BROWN
RD	RED
YL	YELLOW
GN	GREEN
BU	BLUE
VI	VIOLET
GY	GRAY
WT	WHITE
PK	PINK

# 4 SYMBOLS

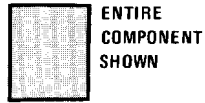

ENTIRE COMPONENT SHOWN

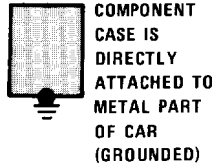

COMPONENT CASE IS DIRECTLY ATTACHED TO METAL PART OF CAR (GROUNDED)

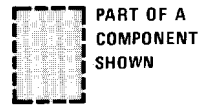

PART OF A COMPONENT SHOWN

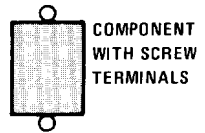

COMPONENT WITH SCREW TERMINALS

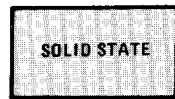

SOLID STATE (INCLUDES ONLY ELECTRONIC PARTS)

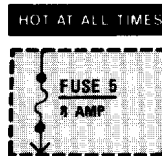

HOT AT ALL TIMES

INDICATES THAT FUSE 5 IS ALWAYS SUPPLIED WITH POWER

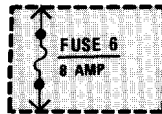

HOT IN RUN OR START

INDICATES THAT FUSE 6 IS SUPPLIED WITH POWER WITH THE IGNITION SWITCH IN THE RUN OR START POSITIONS

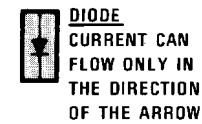
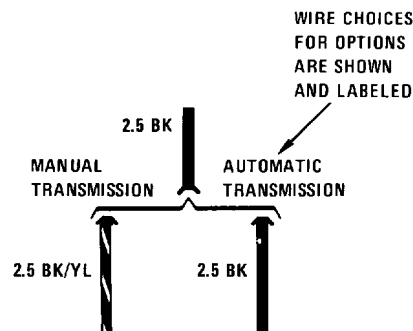
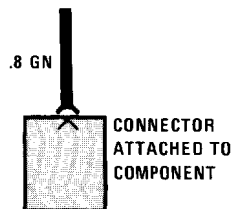
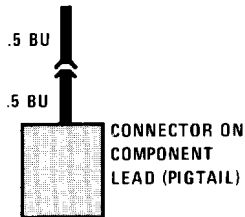
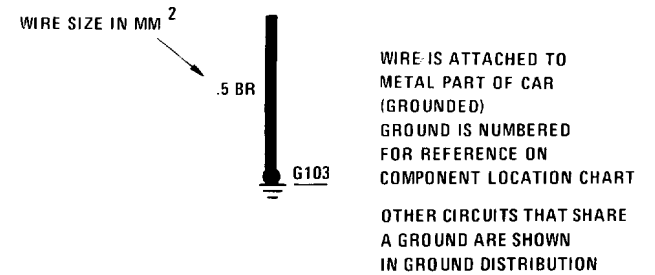
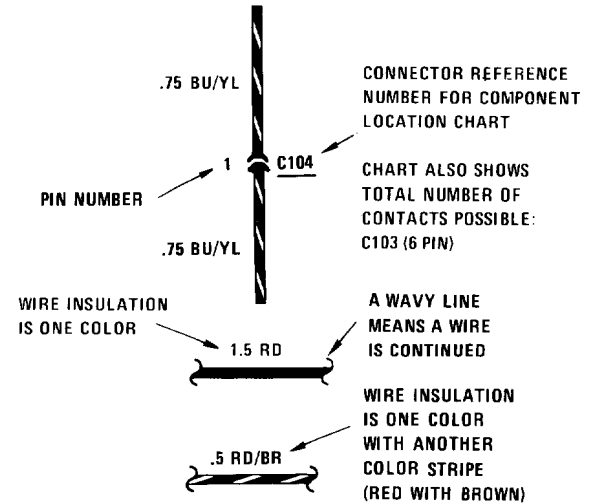

DIODE CURRENT CAN FLOW ONLY IN THE DIRECTION OF THE ARROW

CIRCUIT REFERENCE - A WIRE WHICH CONNECTS TO ANOTHER CIRCUIT



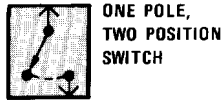

**ONE POLE,  
TWO POSITION  
SWITCH**

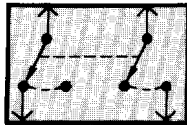

**SWITCHES THAT  
MOVE TOGETHER**  
  
DASHED LINE SHOWS  
A MECHANICAL  
CONNECTION  
BETWEEN SWITCHES

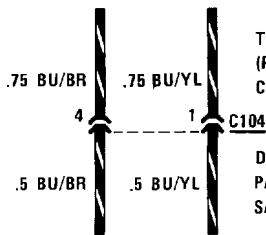

**TWO CONNECTIONS  
(PINS) IN THE SAME  
CONNECTOR**

**DASHED LINE SHOWS  
PARTS OF THE  
SAME CONNECTOR**

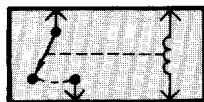

**WHEN COIL IS  
ENERGIZED, SWITCH  
IS PULLED CLOSED**

**RELAY SHOWN  
WITH NO  
CURRENT  
FLOWING  
THROUGH  
COIL**

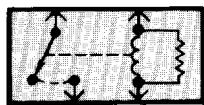

**RESISTOR ACROSS COIL  
IS FOR NOISE  
SUPPRESSION**

**RELAY SHOWN  
WITH RESISTOR  
ACROSS COIL**

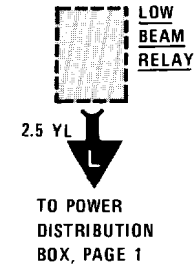
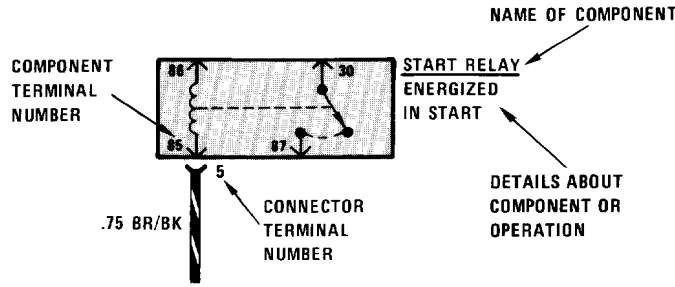

**CURRENT PATH  
IS CONTINUED  
AS LABELED.  
THE ARROW SHOWS  
DIRECTION OF CURRENT  
FLOW AND IS REPEATED  
WHERE CURRENT  
PATH CONTINUES.**

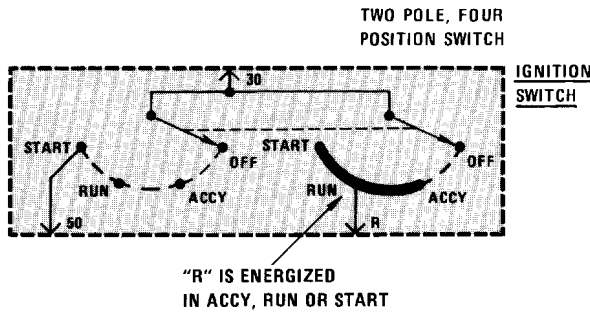

**TWO POLE, FOUR  
POSITION SWITCH**

**IGNITION  
SWITCH**

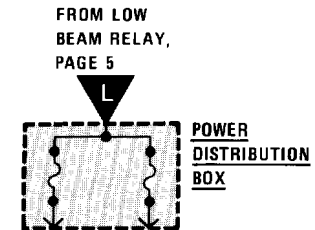

**FROM LOW  
BEAM RELAY,  
PAGE 5**

**POWER  
DISTRIBUTION  
BOX**

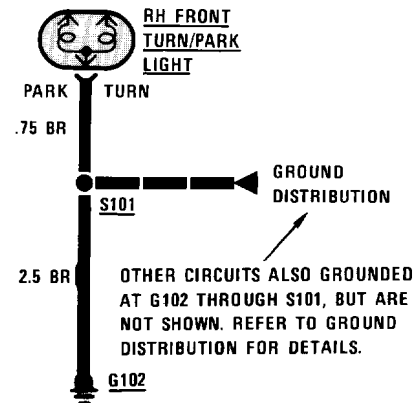

**RH FRONT  
TURN/PARK  
LIGHT**



**LIGHT  
EMITTING  
DIODE**

## 6 SYSTEMATIC TROUBLESHOOTING

### TROUBLESHOOTING PROCEDURE

#### 1. Verify the Problem

Operate the problem circuit to check the accuracy of the complaint. Note the symptoms of the inoperative circuit.

#### 2. Analyze the Problem

Refer to the schematic of the problem circuit in the ETM. Determine how the circuit is supposed to work by tracing the current path(s) from the power feed through the circuit components to ground. Then based on the symptoms you noted in step 1 and your understanding of circuit operation, identify one or more possible causes of the problem.

#### 3. Isolate the Problem

Make circuit tests to prove or disprove the preliminary diagnosis made in step 2. Keep in mind that a logical simple procedure is the key to efficient troubleshooting. Test for the most likely cause of failure first. Try to make tests at points which are easily accessible.

#### 4. Repair the Problem

Once the specific problem is identified, make the repair using the proper tools and safe procedures.

#### 5. Check the Problem

Operate the circuit to check for satisfactory circuit operation. Good repair practice calls for rechecking all circuits you have worked on.

### TROUBLESHOOTING TOOLS

Isolating the problem (Step 3 of TROUBLESHOOTING PROCEDURES) requires the use of a **voltmeter** and/or **ohmmeter**. A voltmeter measures voltage at selected points in a circuit. An ohmmeter measures a circuit's resistance to current flow. It has an internal battery that provides current to the circuit under test. Disconnect the car battery when using an ohmmeter because the battery voltage will cause the ohmmeter to give false readings. Also, do not use an ohmmeter on solid-state components. The voltage that the ohmmeter applies to the circuit could damage these components.

### TROUBLESHOOTING TESTS

#### Voltage Test

This test measures voltage in a circuit. By taking measurements at several points (terminals or connectors) along the circuit, you can isolate the problem.

To take a voltage measurement, connect the negative lead of the voltmeter to the battery's negative terminal or other known good ground. Then connect the positive lead of the voltmeter to the point you want to test. The voltmeter will measure the voltage present at that point in the circuit.

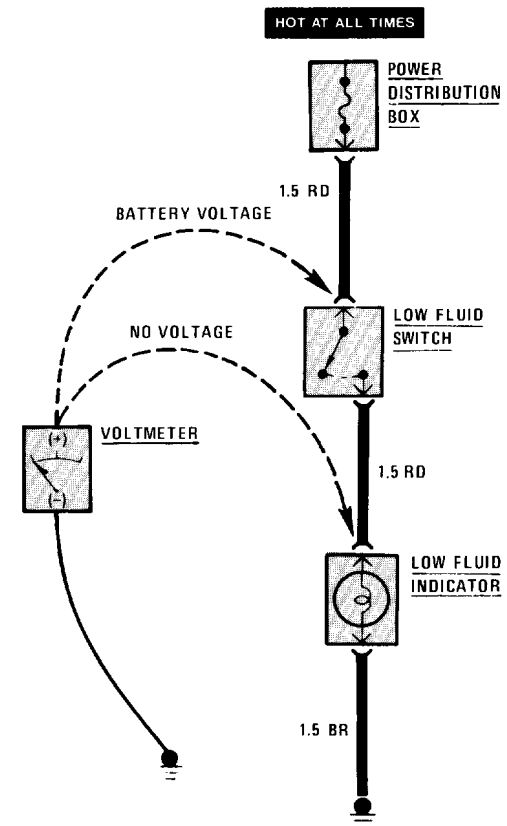

Voltage Test



Voltage Drop Test

Wires, connectors, and switches are designed to conduct current with a minimum loss of voltage. A voltage drop of more than one volt indicates a problem.

To test for voltage drop, connect the voltmeter leads to connectors at either end of the circuit's suspected problem area. The positive lead should be connected to the connector closest to the power source. The voltmeter will show the voltage drop between these two points.

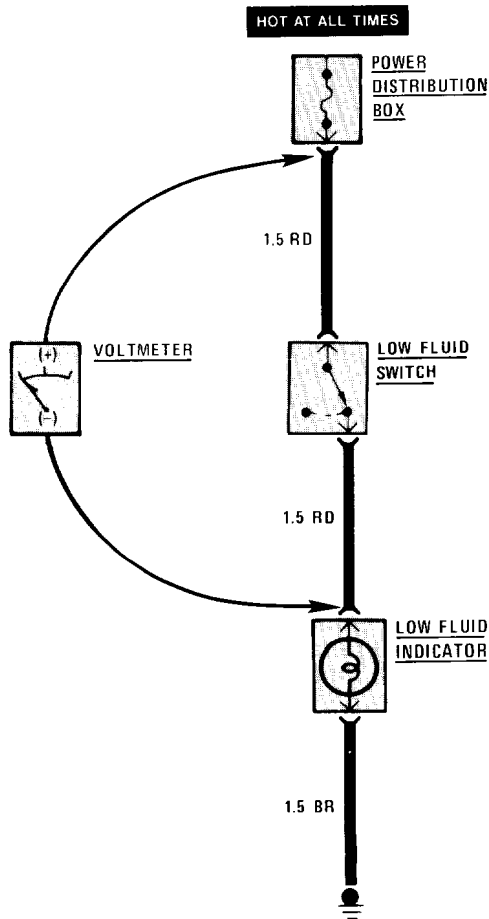

Voltage Drop Test

Continuity Test

To perform a continuity test, first disconnect the car battery. Then adjust the ohmmeter to read zero while holding the leads together. Connect the ohmmeter leads to connector or terminals at either end of the circuit's suspected problem area. The ohmmeter will show the resistance across that part of the circuit.

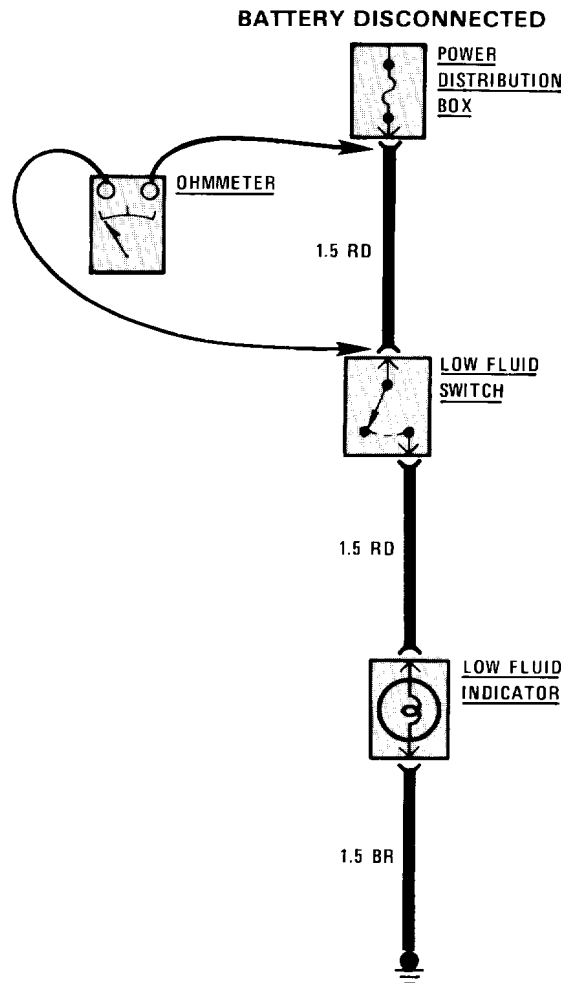

Continuity Test

Short Test Using Voltmeter

Remove the blown fuse and disconnect the load. Connect the voltmeter leads to the fuse terminals. The positive lead should be connected to the terminal closest to the power source.

Starting near the POWER DISTRIBUTION BOX, move the wire harness back and forth and watch the voltmeter reading. If the voltmeter registers a reading, there is a short to ground in the wiring. Somewhere in the area of the harness being moved, the wire insulation is worn away and the circuit is grounding.

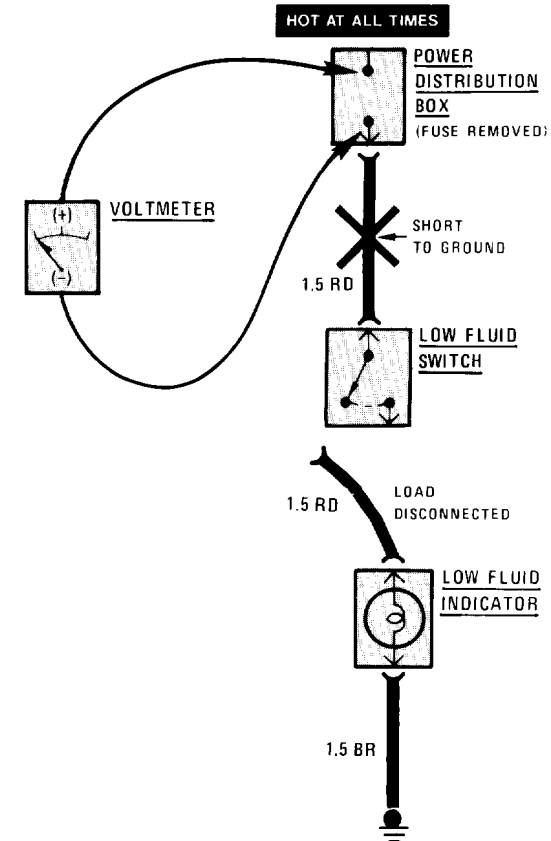

Short Test Using Voltmeter

## 8 SYSTEMATIC TROUBLESHOOTING

### Short Test Using Ohmmeter

Disconnect the battery. Adjust the ohmmeter to read zero while holding the leads together. Remove the blown fuse and disconnect the load. Connect one lead of the ohmmeter to the fuse terminal that is closest to the load. Connect the other lead to a known good ground.

Starting near the POWER DISTRIBUTION BOX, move the wire harness back and forth and watch the ohmmeter reading. Low or no resistance indicates a short to ground in the wiring. Infinitely high resistance indicates no short.

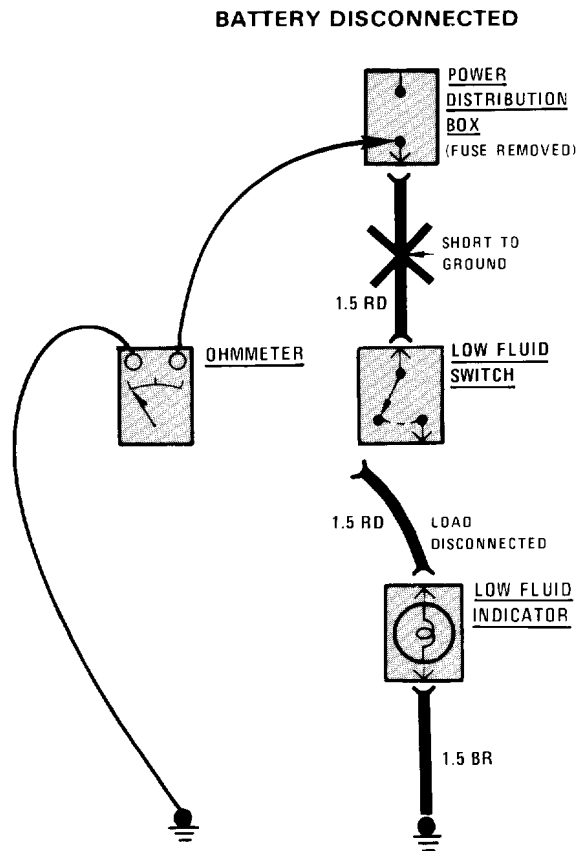

Short Test Using Ohmmeter

# 0670-0 POWER DISTRIBUTION

## POWER DISTRIBUTION BOX

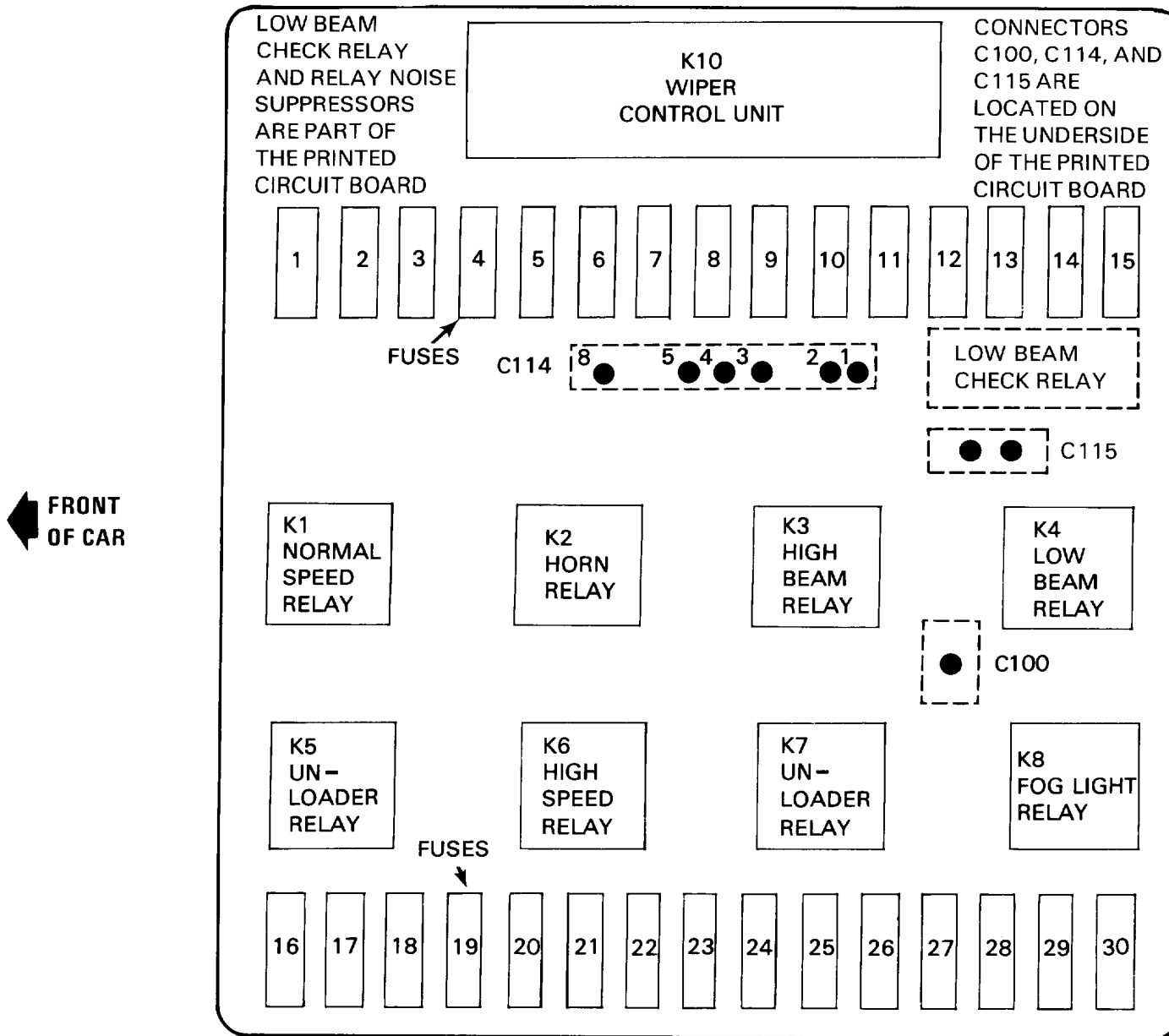

**FUSE DATA CHART**

FUSE NO.	SIZE/ COLOR	CIRCUIT NAME
1	7.5A	Headlights (also fuses 2, 13, 14).
2	7.5A	Headlights (also fuses 1, 13, 14).
3	15A	Auxiliary Fan (also fuses 18, 19, 20).
4	15A	Lights: Turn/Hazard (also fuse 24); Active Check Control (also fuses 6, 10, 21, 22, 23).
5	30A	Wiper/Washer.
6	7.5A	Stop Lights; Map Reading Light; Cruise Control; Active Check Control (also fuses 4, 10, 21, 22, 23); Glove Box Light; Antilock Braking System (also fuse 10).
7	15A	Horn.
8	30A	Rear Defogger (also fuse 23).
9	15A	Injection Electronics (also fuses 11, 21).
10	7.5A	Seatbelt Warning (also fuse 21); Service Interval Indicator (also fuse 21); Antilock Braking System (also fuse 6); Tachometer/Fuel Economy Gauges (also fuse 21); Gauges/Indicators; Brake Warning System; Back Up Lights; On-Board Computer (also fuses 12, 21, 27); Start; Active Check Control (also fuses 4, 6, 21, 22, 23).
11	7.5A	Injection Electronics (also fuses 9, 21).
12	7.5A	Radio/Antenna (also fuses 21, 27, 28); Speedometer/Indicators; On-Board Computer (also fuses 10, 21, 27).
13	7.5A	Headlights (also fuses 1, 2, 14).
14	7.5A	Headlights (also fuses 1, 2, 13).
15	7.5A	Not Used.
16	15A	Not Used.
17	30A	Sunroof; Power Windows.
18	30A	Auxiliary Fan (also fuses 3, 19, 20).
19	7.5A	Auxiliary Fan (also fuses 3, 18, 20); Interior Lights (also fuses 21, 27); Power Mirrors.

FUSE NO.	SIZE/ COLOR	CIRCUIT NAME
20	30A	Heater/Air Conditioning; Auxiliary Fan (also fuses 3, 18, 19).
21	7.5A	Auto-Charging Flashlight; Ignition Key Warning/Seatbelt Warning; (also fuse 10); Injection Electronics (also fuses 10, 11); Interior Lights (also fuses 19, 27); Radio/Antenna (also fuses 12, 27, 28); Trunk Light; Active Check Control (also fuses 4, 6, 10, 22, 23); Service Interval Indicator (also fuse 10); On-Board Computer (also fuses 10, 12, 27); Tachometer/Fuel Economy Gauge (also fuse 10).
22	7.5A	Active Check Control (also fuses 4, 6, 10, 21, 23); Lights: Front Park/Tail (also fuse 23); Lights: Front Side Marker (also fuse 23).
23	7.5A	Lights: Dash Lights: Front Park/Tail (also fuse 22); Lights: Front Side Marker (also fuse 22); Lights: Rear Marker/License; Active Check Control (also fuses 4, 6, 10, 21, 22); Rear Defogger (also fuse 8).
24	15A	Lights: Turn/Hazard (also fuse 4).
25	—	Not Used.
26	15A	Not Used.
27	30A	Interior Lights (also fuses 19, 21); Central Locking; Radio/Antenna (also fuses 12, 21, 28); On-Board Computer (also fuses 10, 12, 21).
28	30A	Cigar Lighter; Radio/Antenna (also fuses 12, 21, 27).
29	7.5A	Fog Lights (also fuse 30).
30	7.5A	Fog Lights (also fuse 29).
POWER WINDOW CIRCUIT BREAKER		25A Power Windows



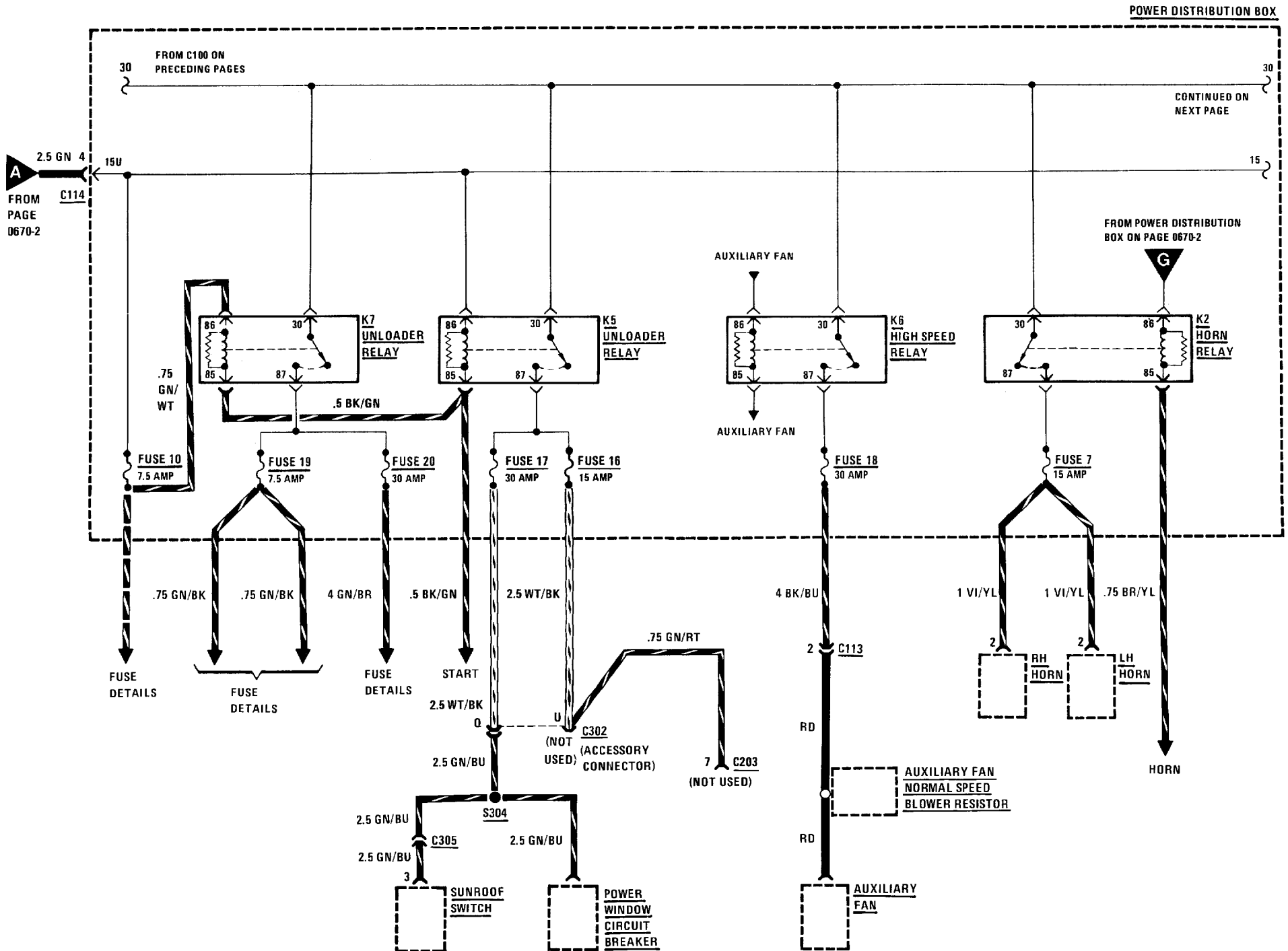

# 0670-4 POWER DISTRIBUTION

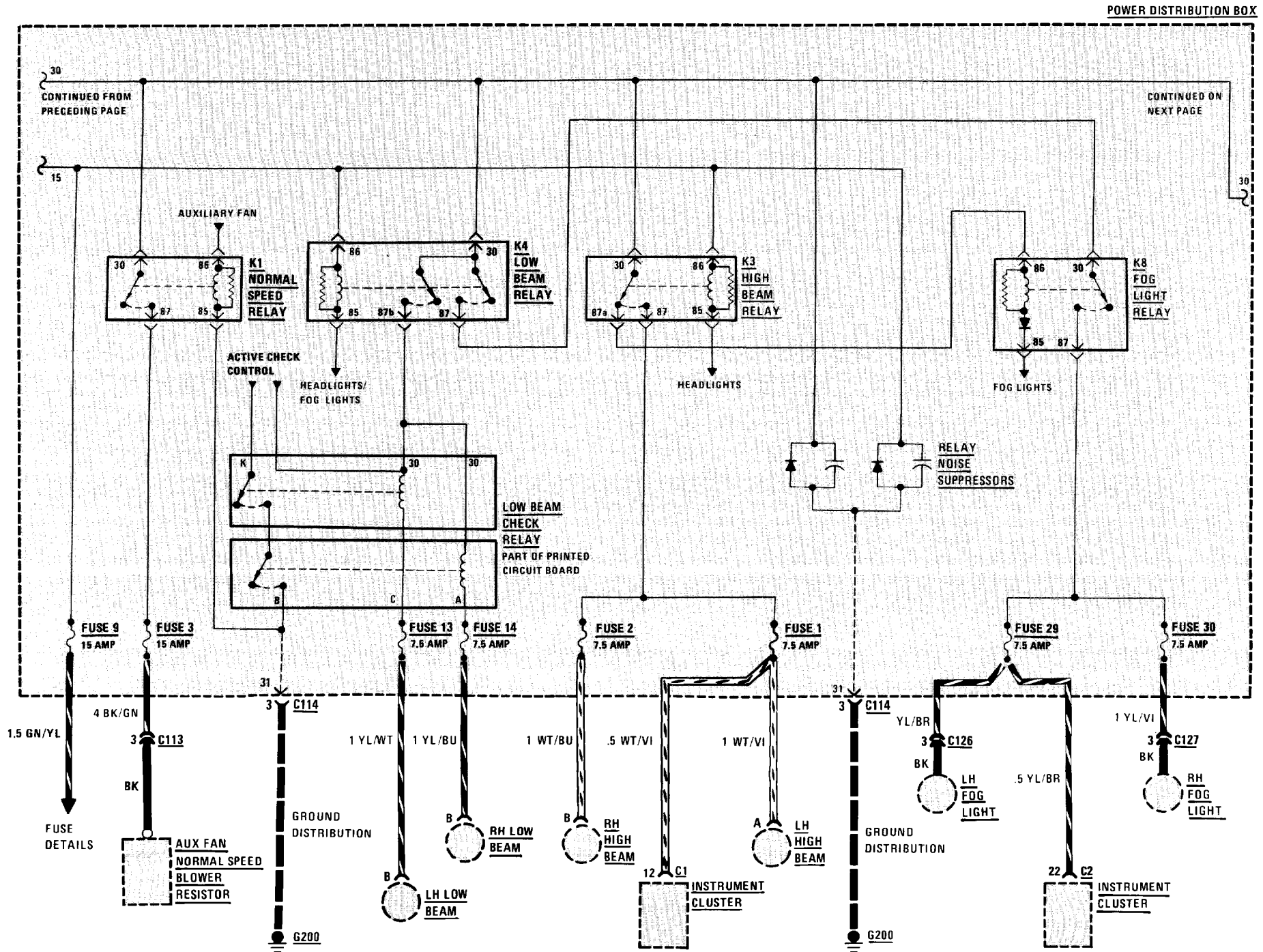





# 0670-6 POWER DISTRIBUTION

## FUSE DETAILS: FUSES 4, 5, AND 6

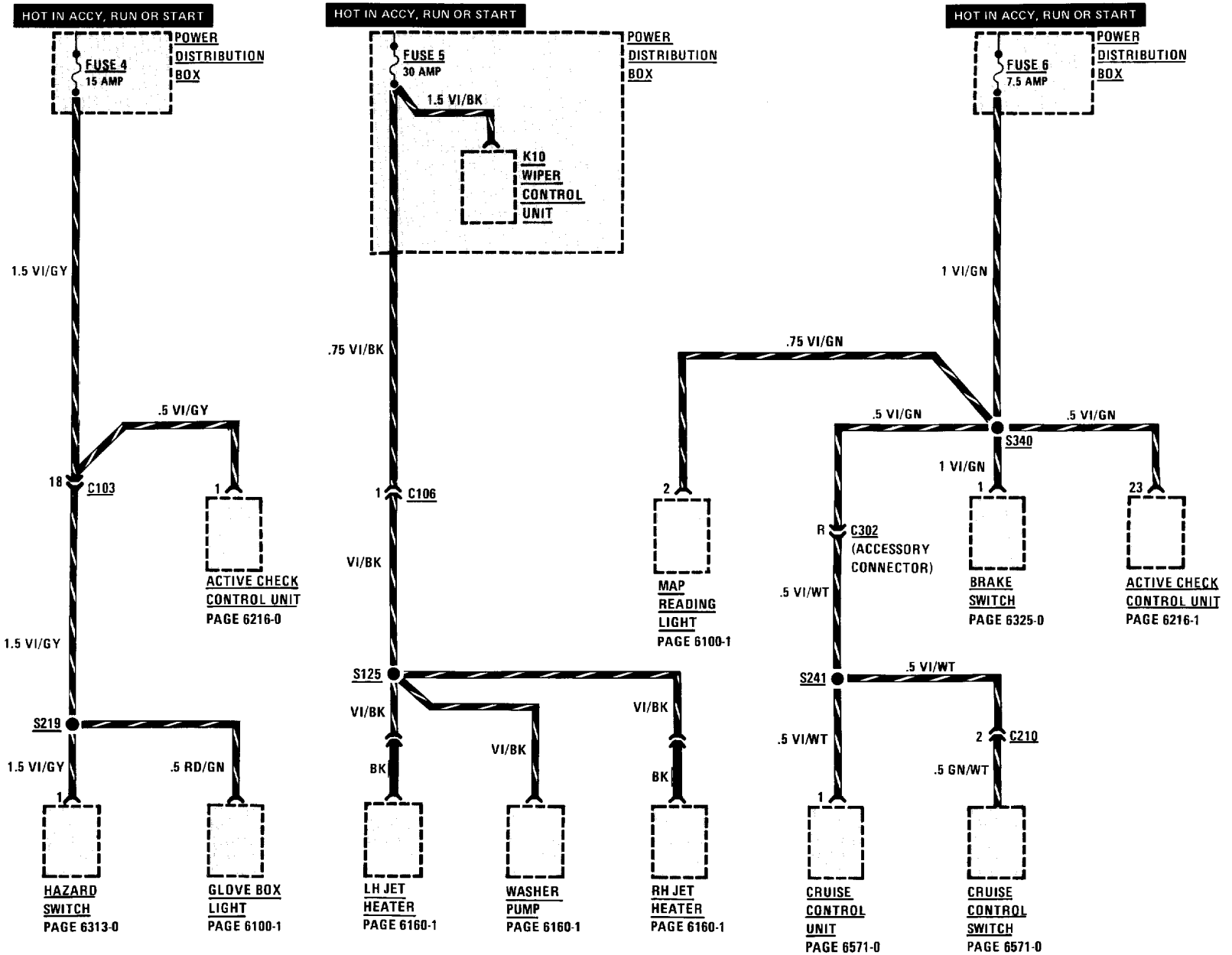

FUSE DETAILS: FUSES 8, 12 AND 19

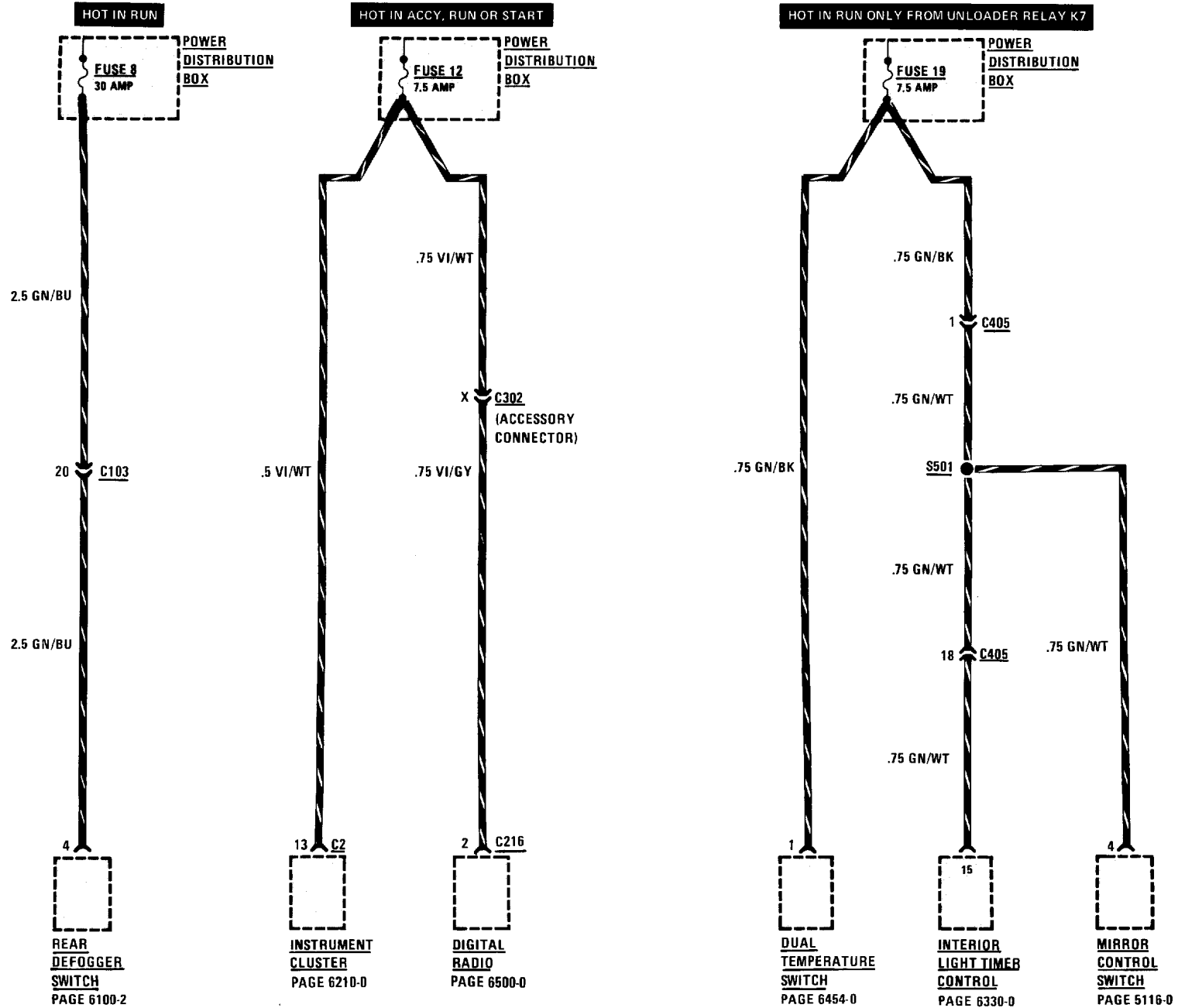

# 0670-8 POWER DISTRIBUTION

## FUSE DETAILS: FUSE 10

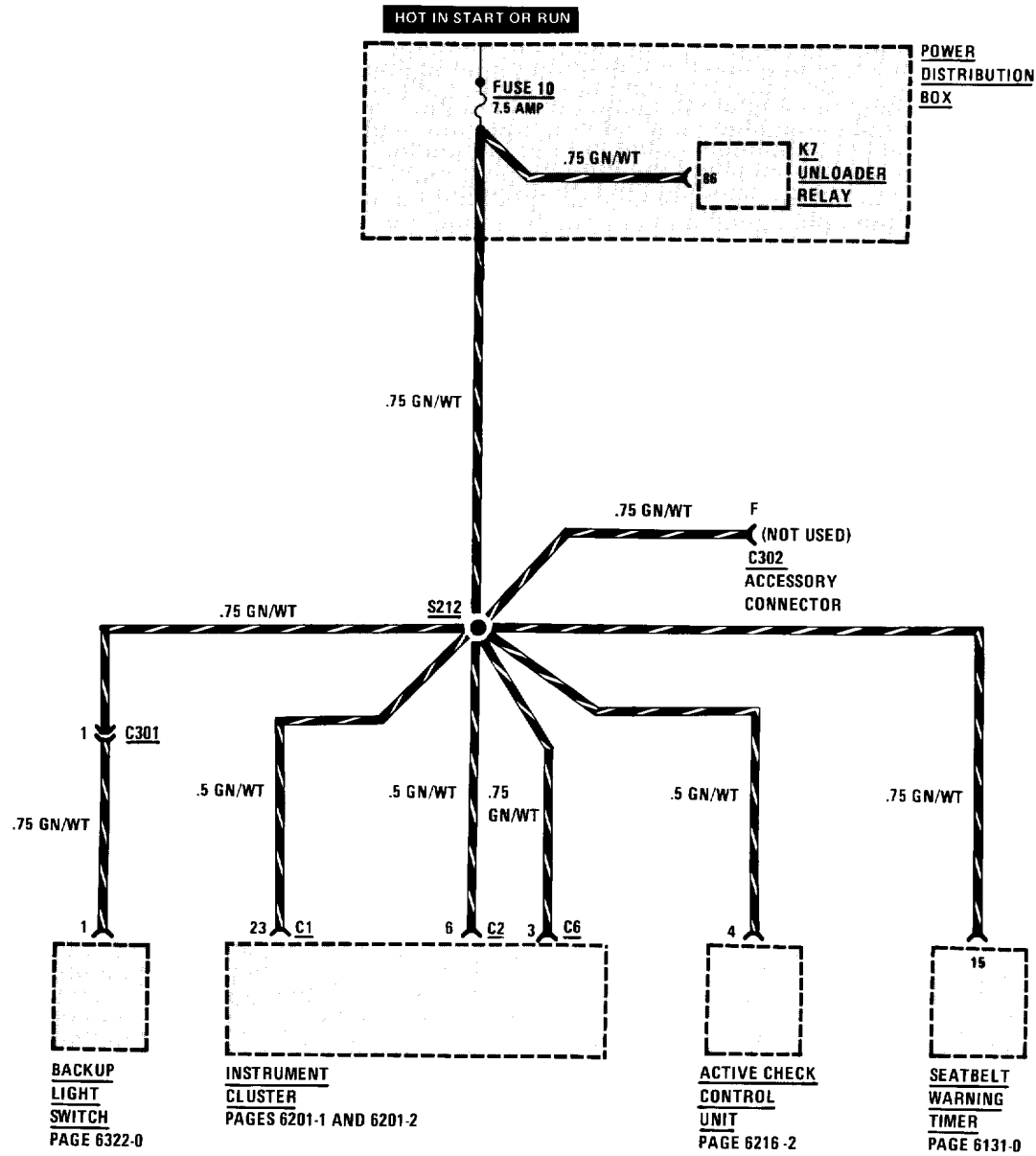

FUSE DETAILS: FUSE 20

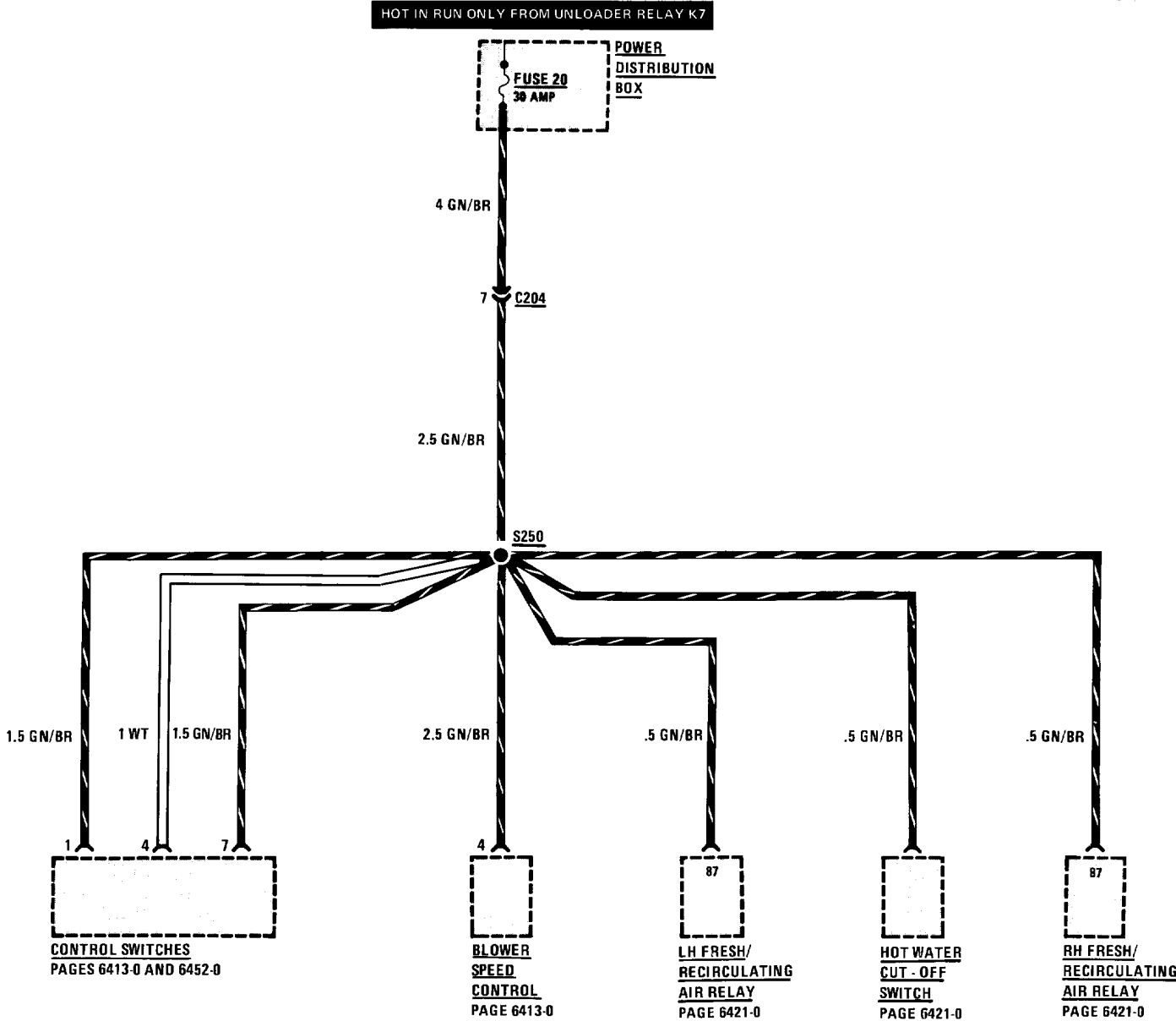

FUSE DETAILS: FUSE 21

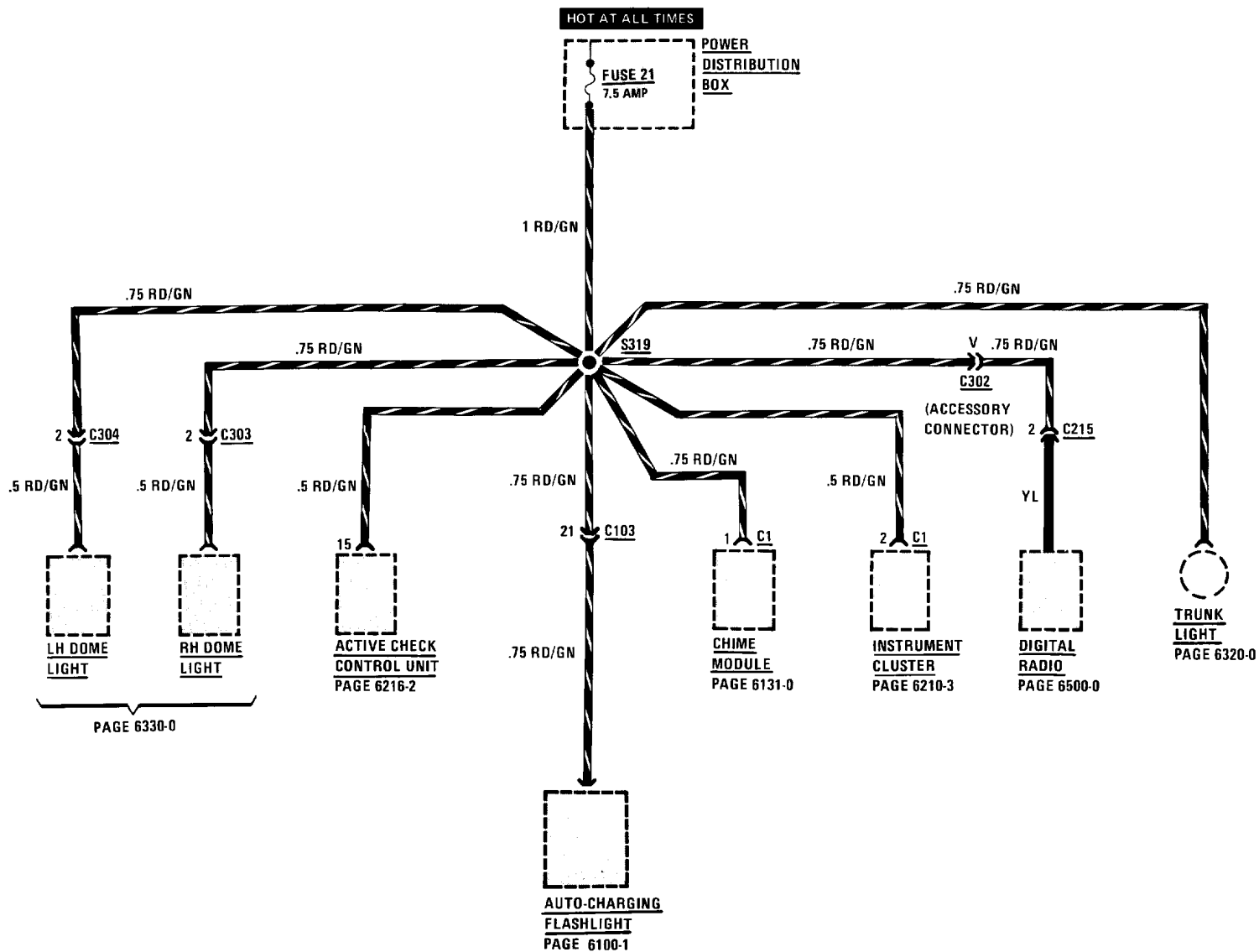

FUSE DETAILS: FUSES 27 AND 9

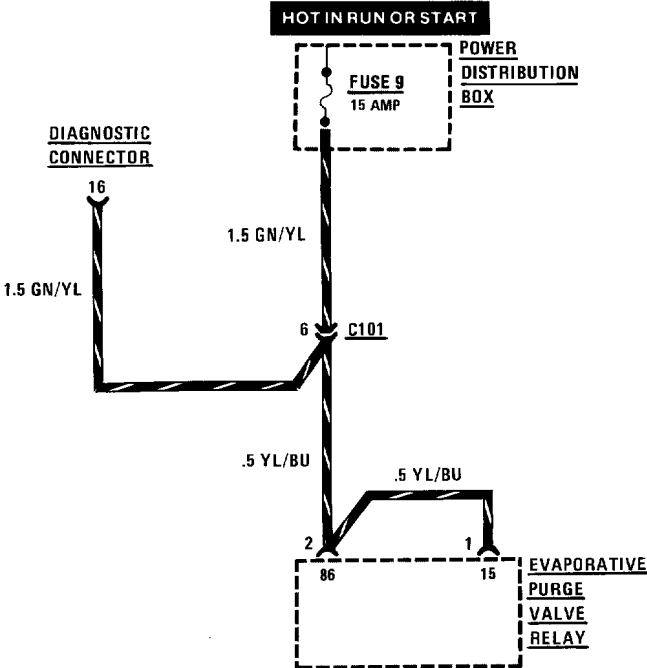
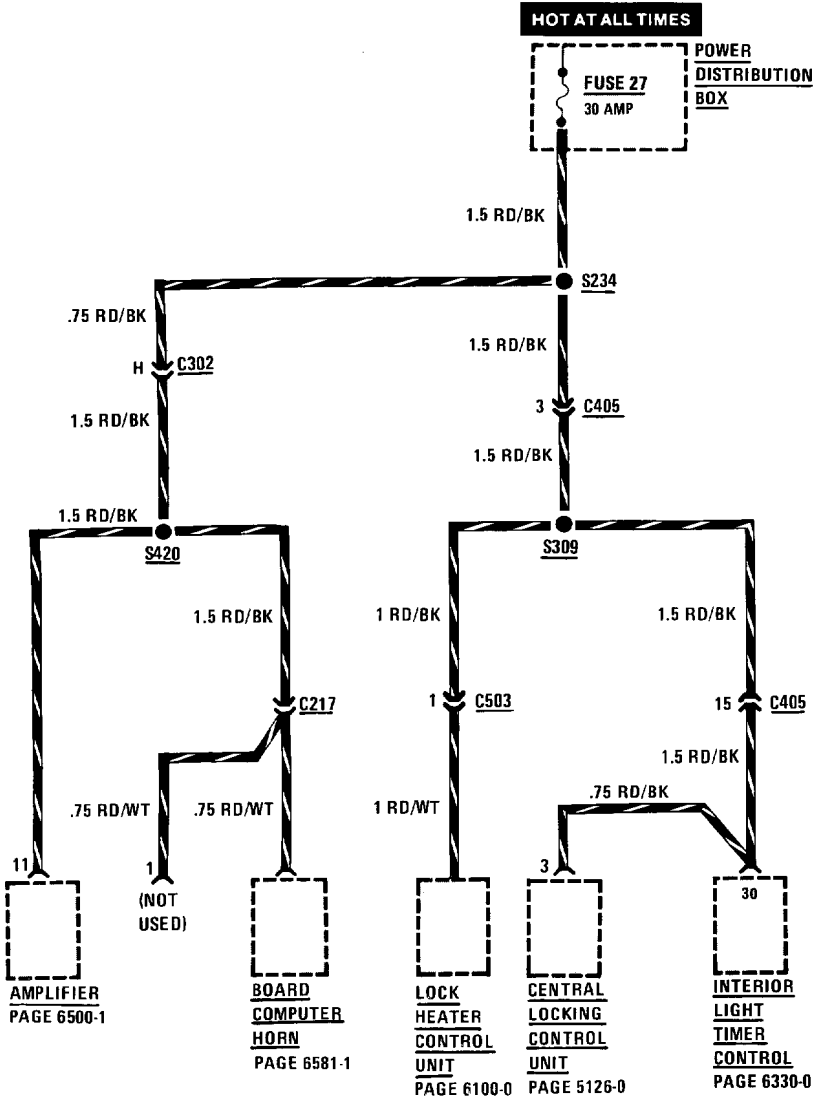

# 0670-12 POWER DISTRIBUTION

## GROUND DISTRIBUTION (G103)

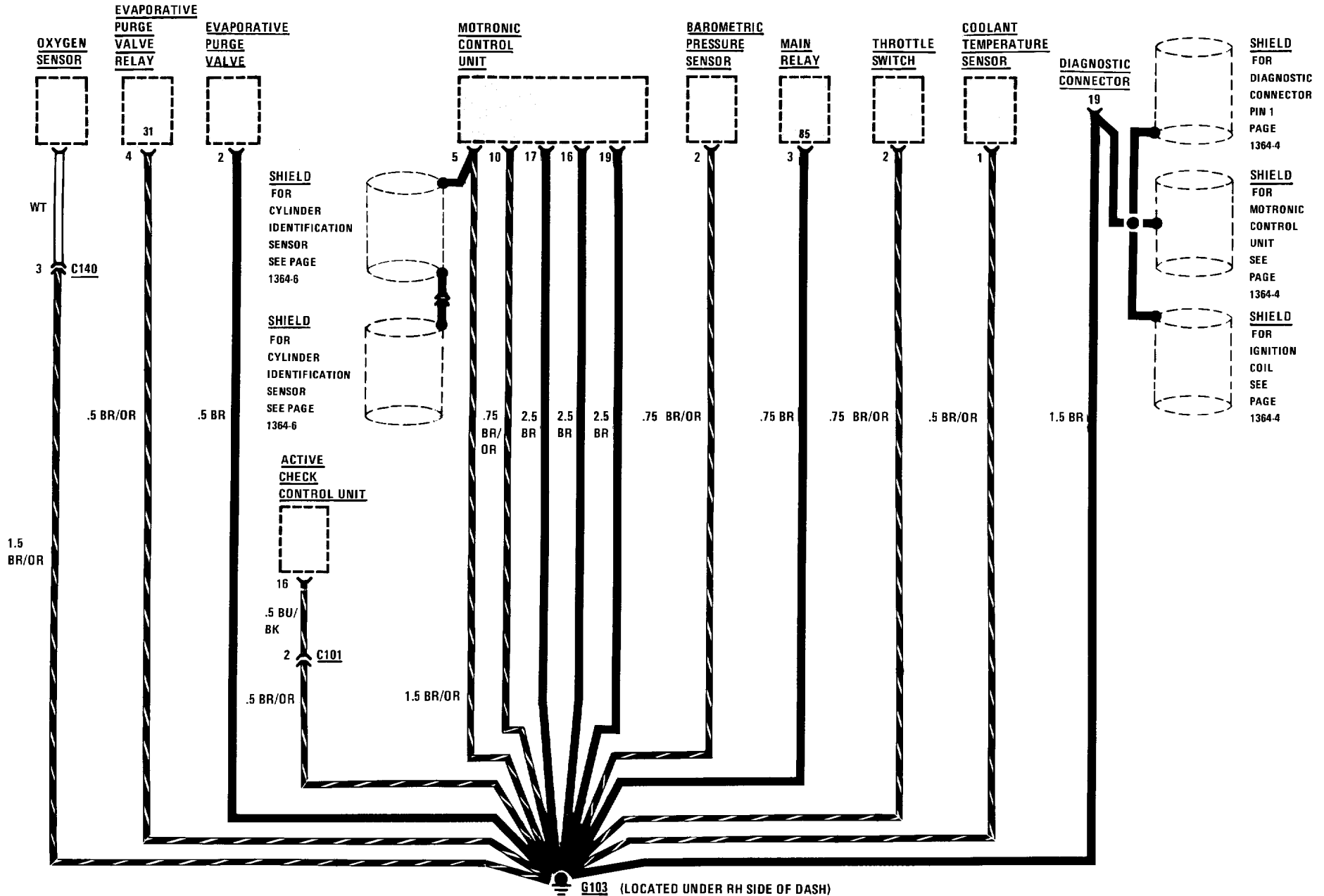

GROUND DISTRIBUTION G104 AND G200 (PARTIAL)

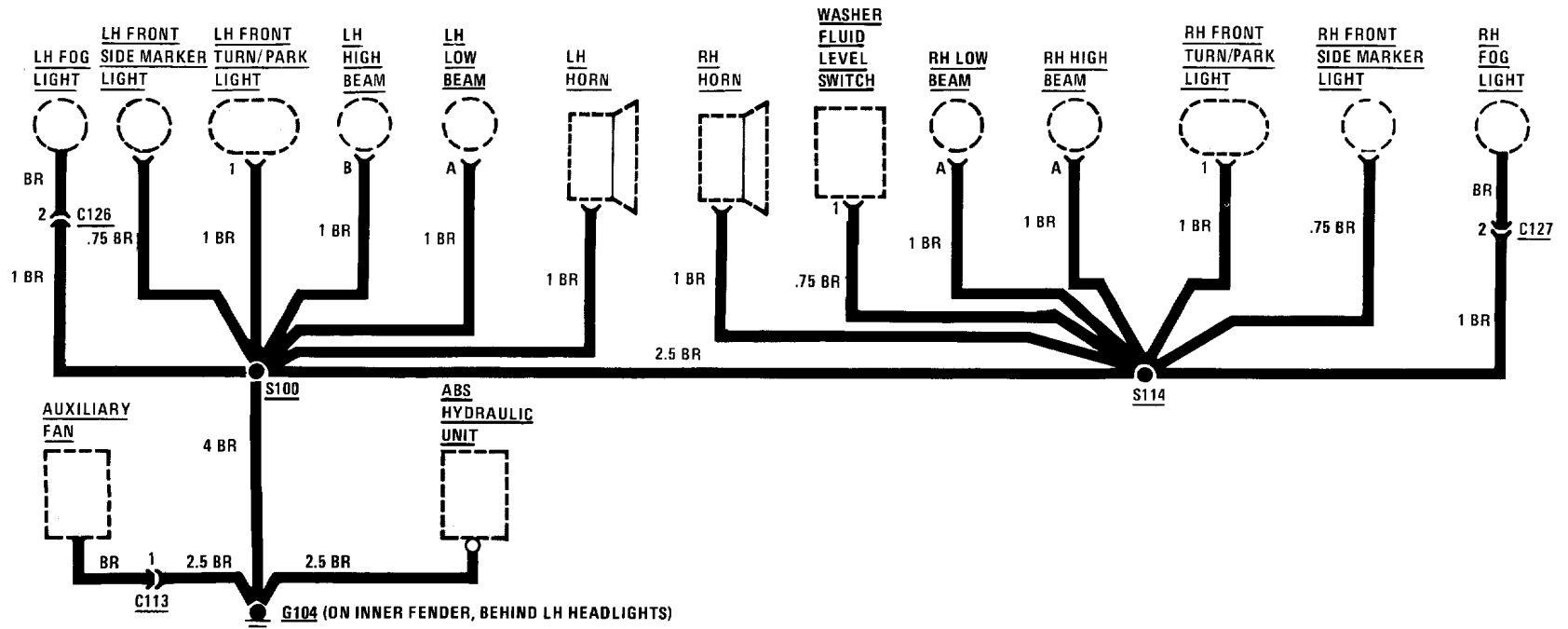
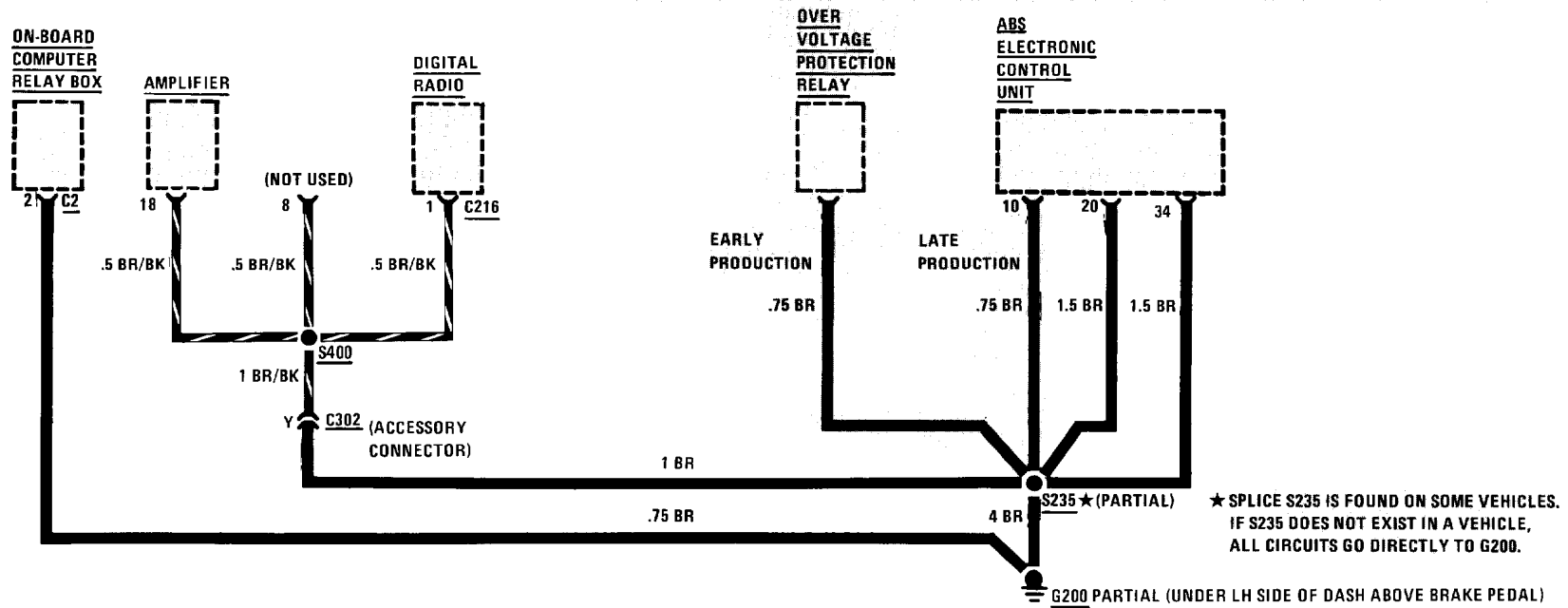



# 0670-14 POWER DISTRIBUTION

## GROUND DISTRIBUTION: G200 (PARTIAL) AND G201

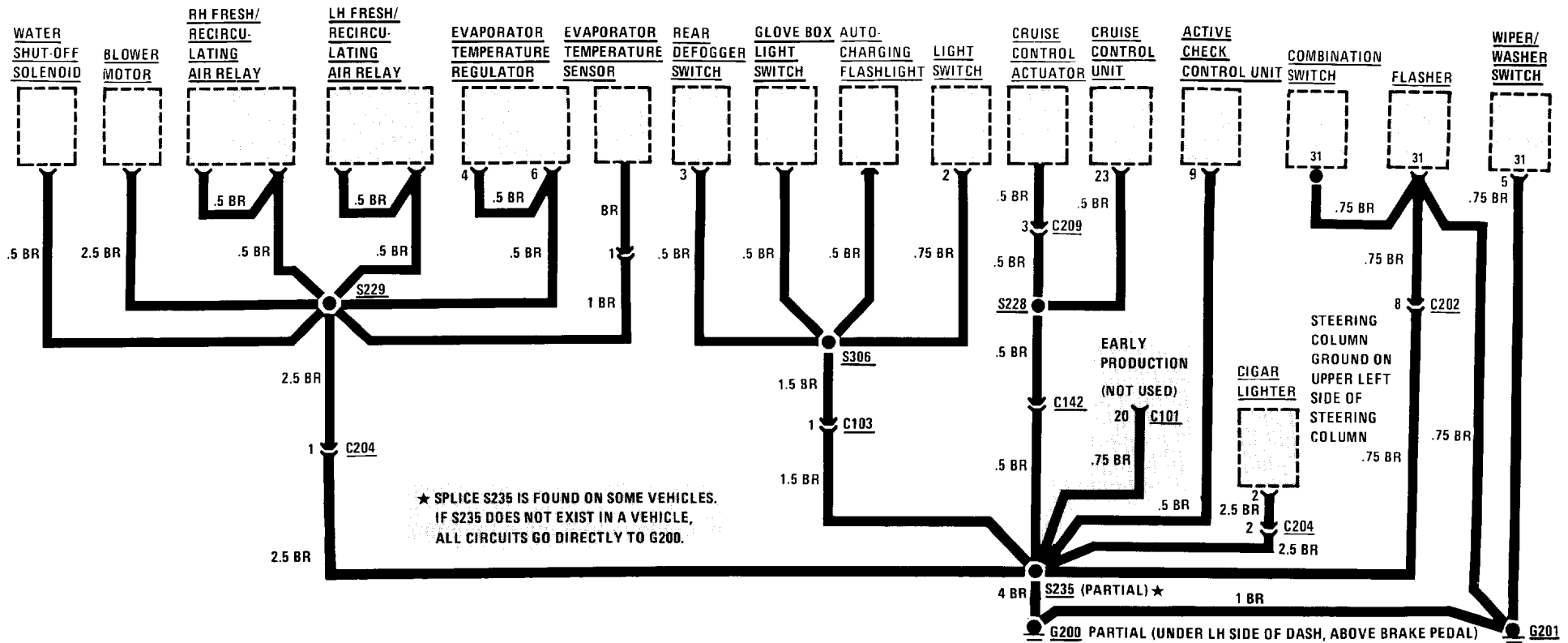
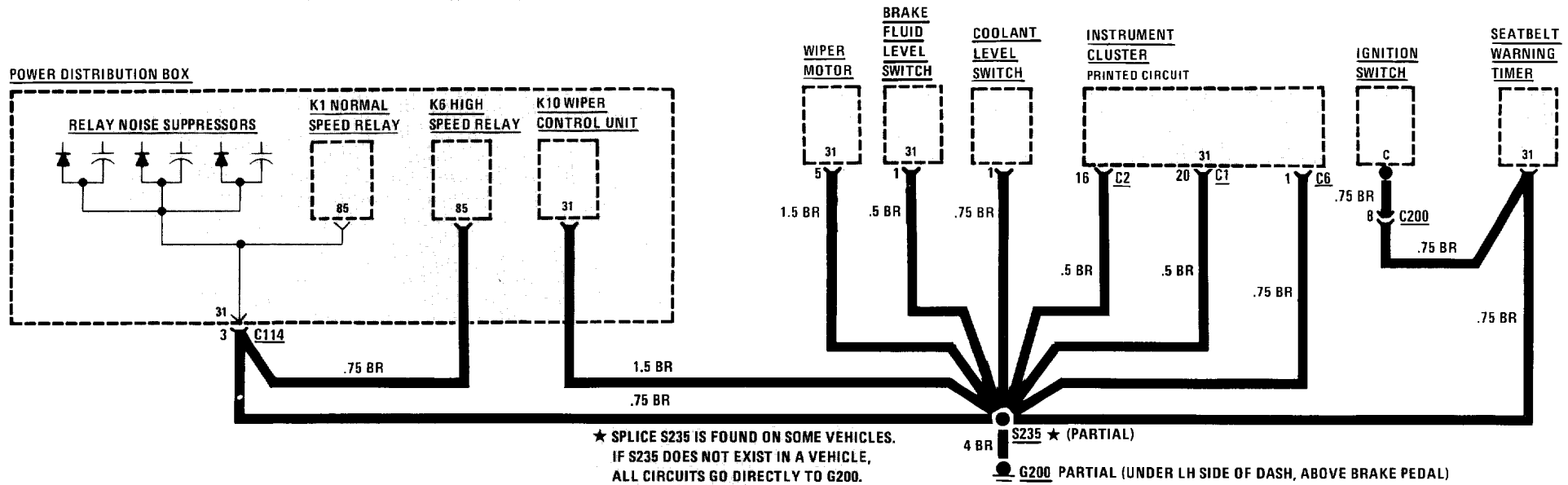

GROUND DISTRIBUTION: G200 (PARTIAL) AND G300

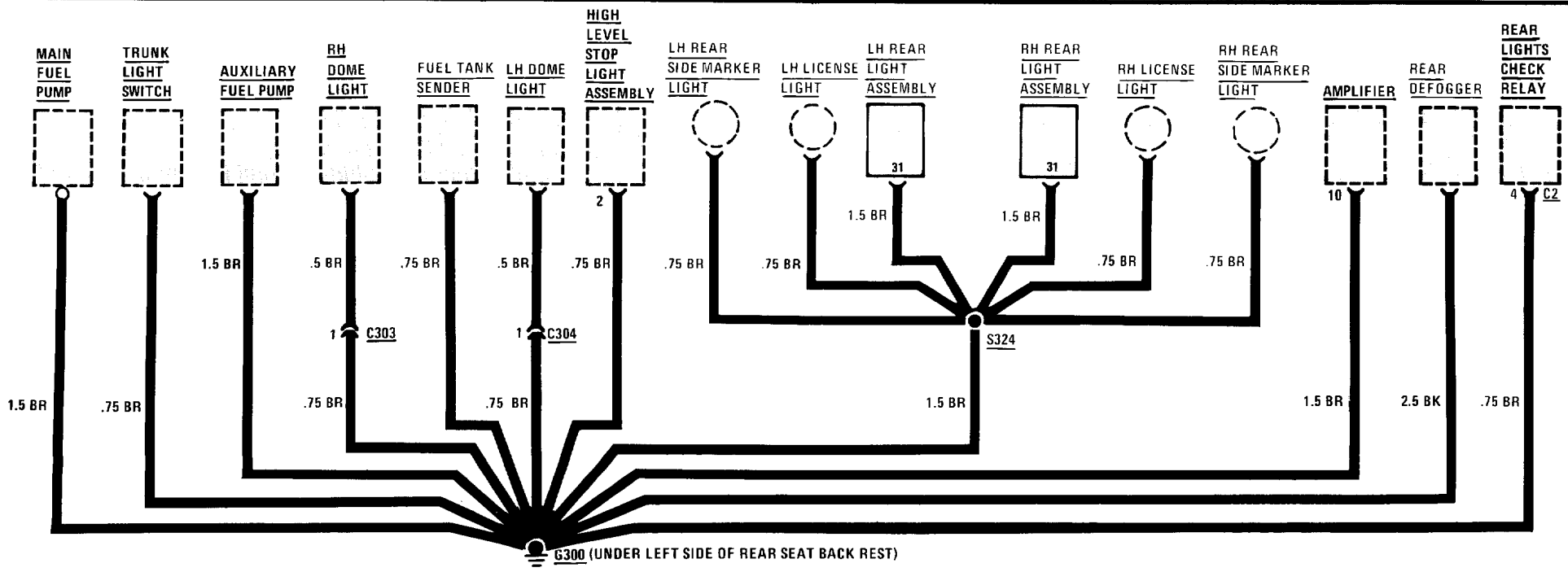
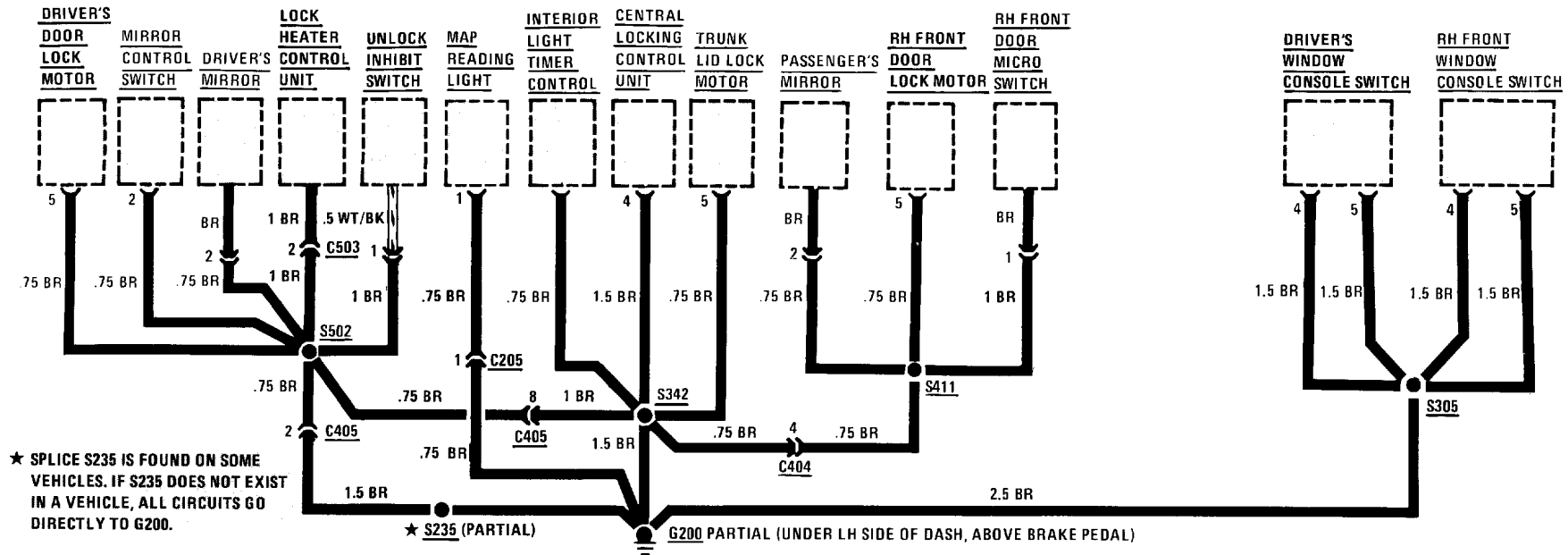

# 1230-0 CHARGE

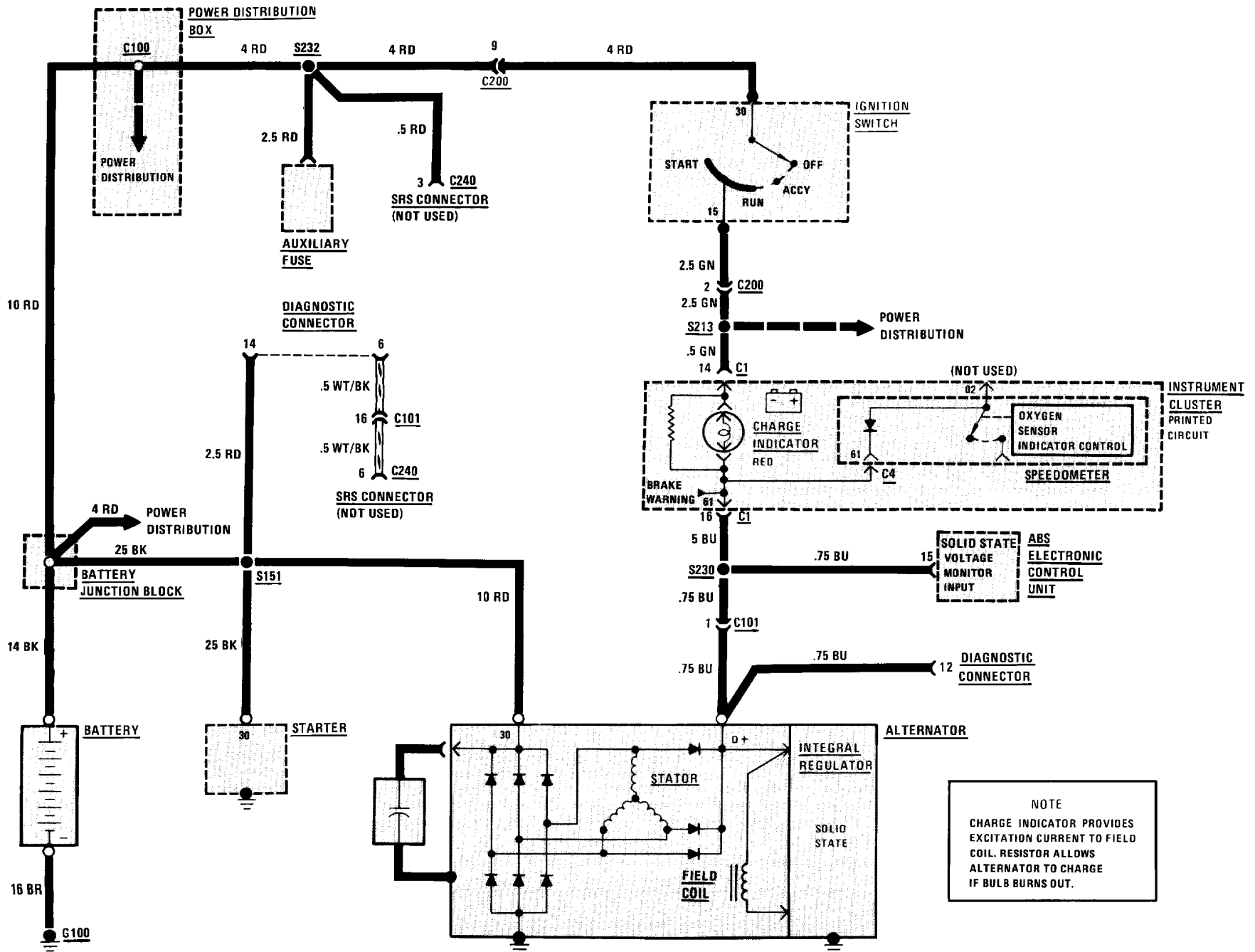



ENGINE BLOCK DIAGRAM

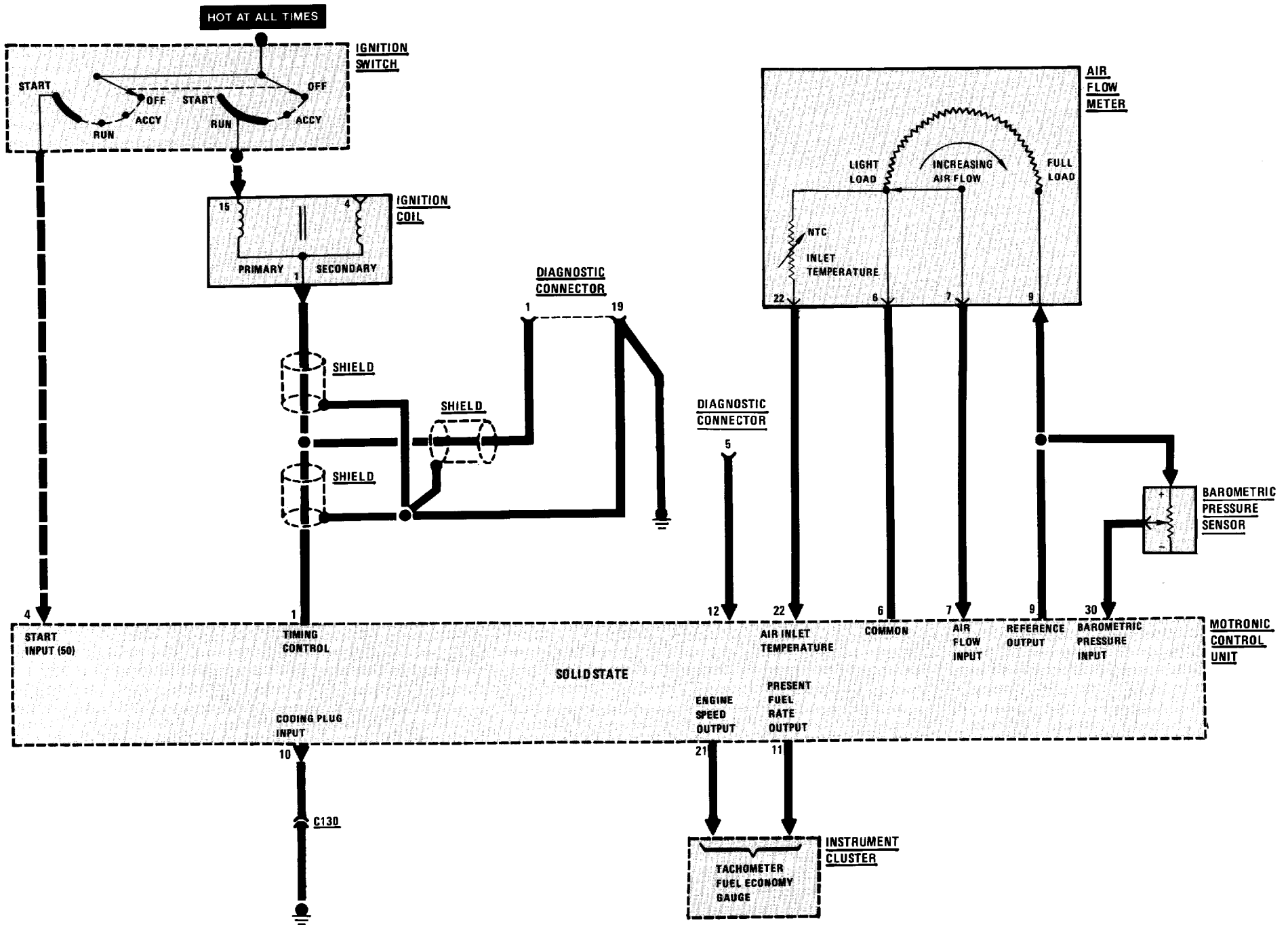

ENGINE BLOCK DIAGRAM

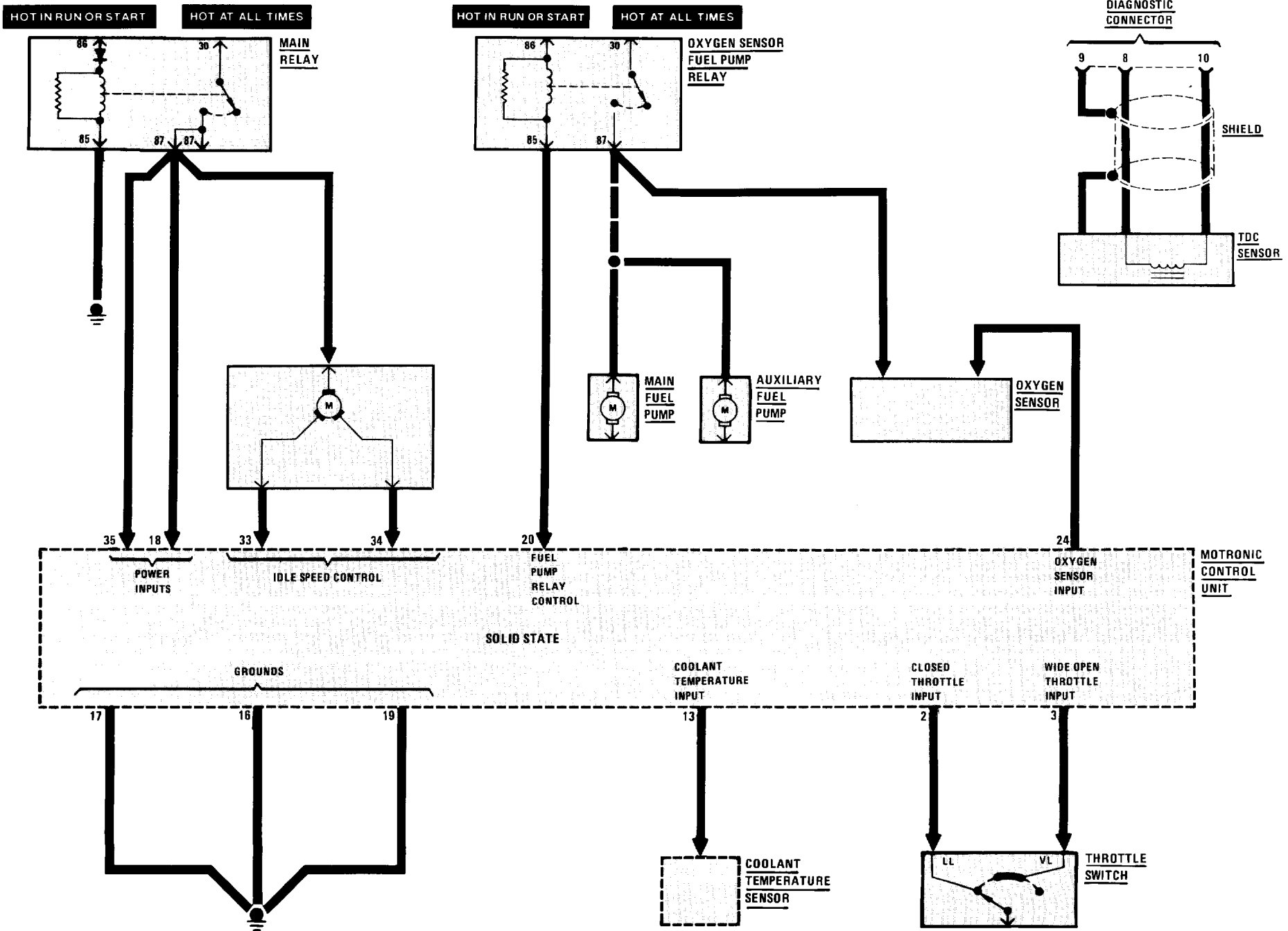

# 1364-2 INJECTION ELECTRONICS S14 ENGINE

## ENGINE BLOCK DIAGRAM

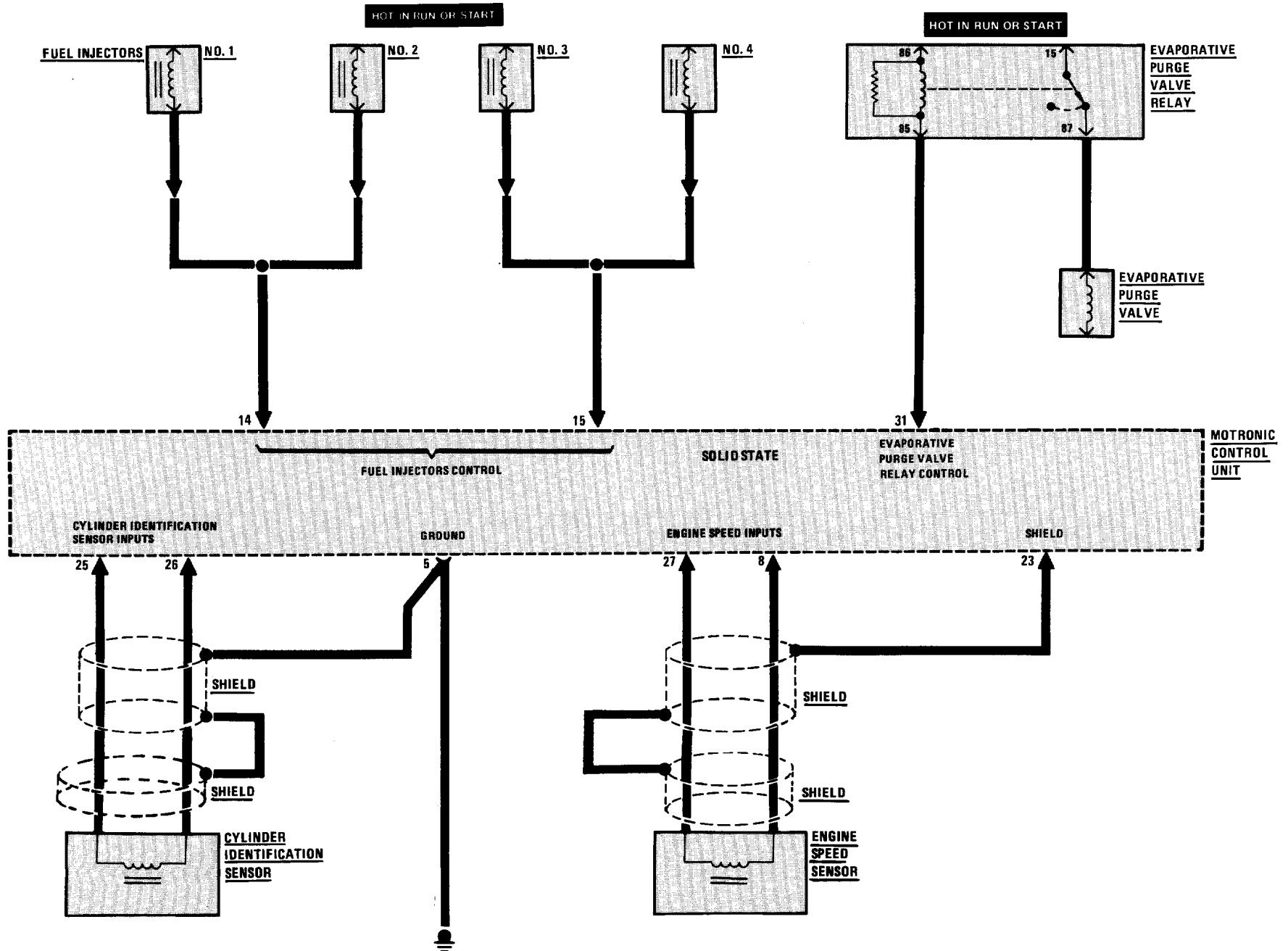

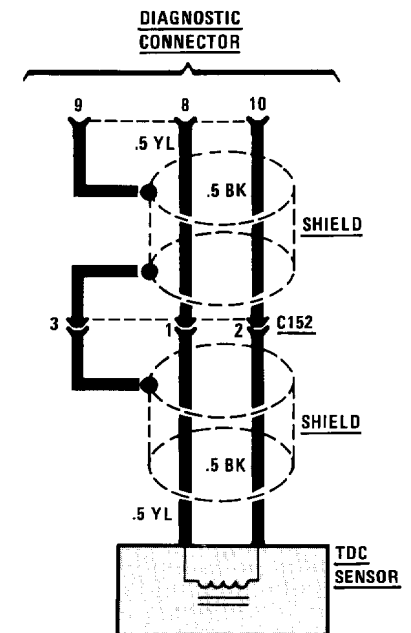
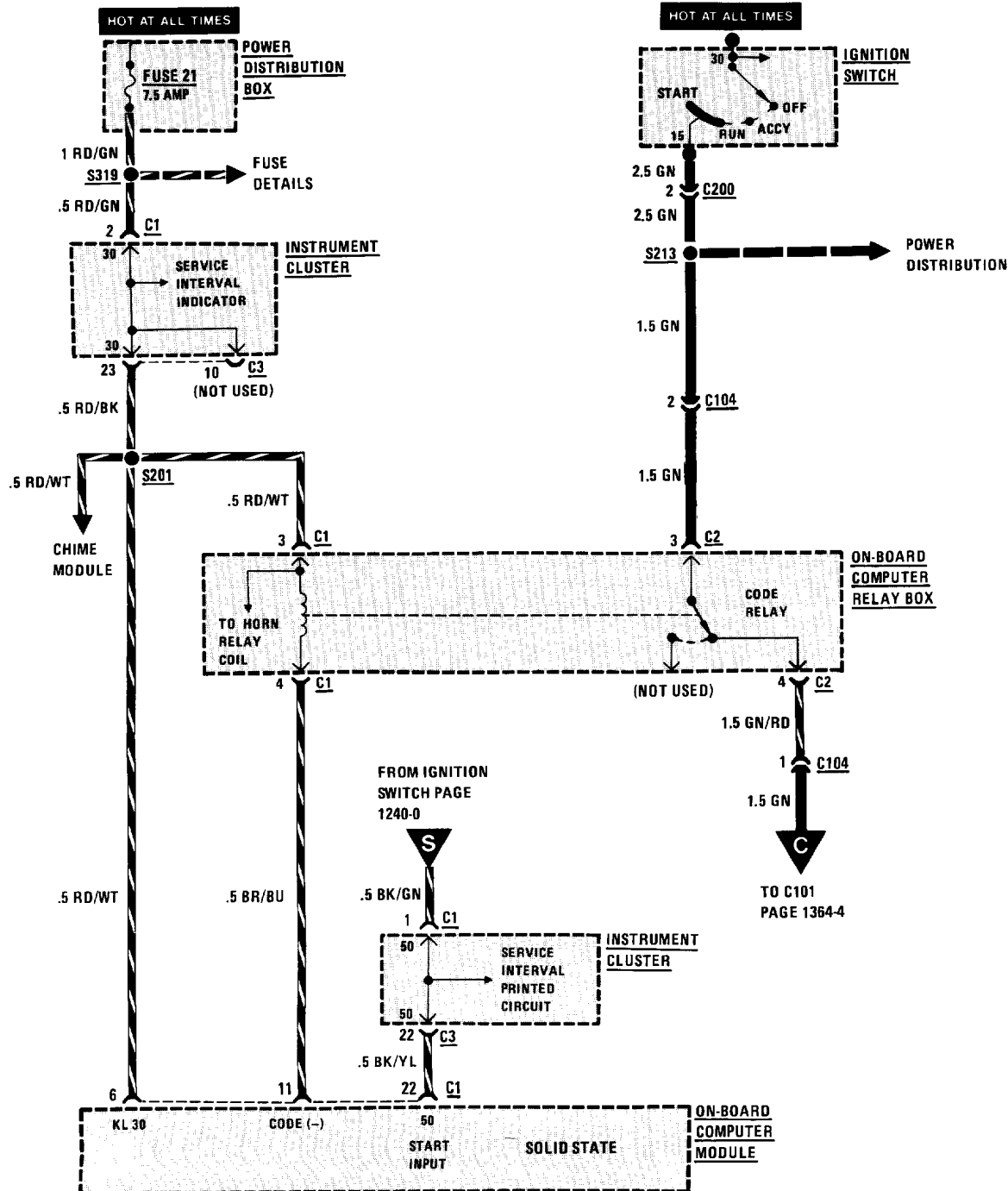



# 1364-4 INJECTION ELECTRONICS S14 ENGINE

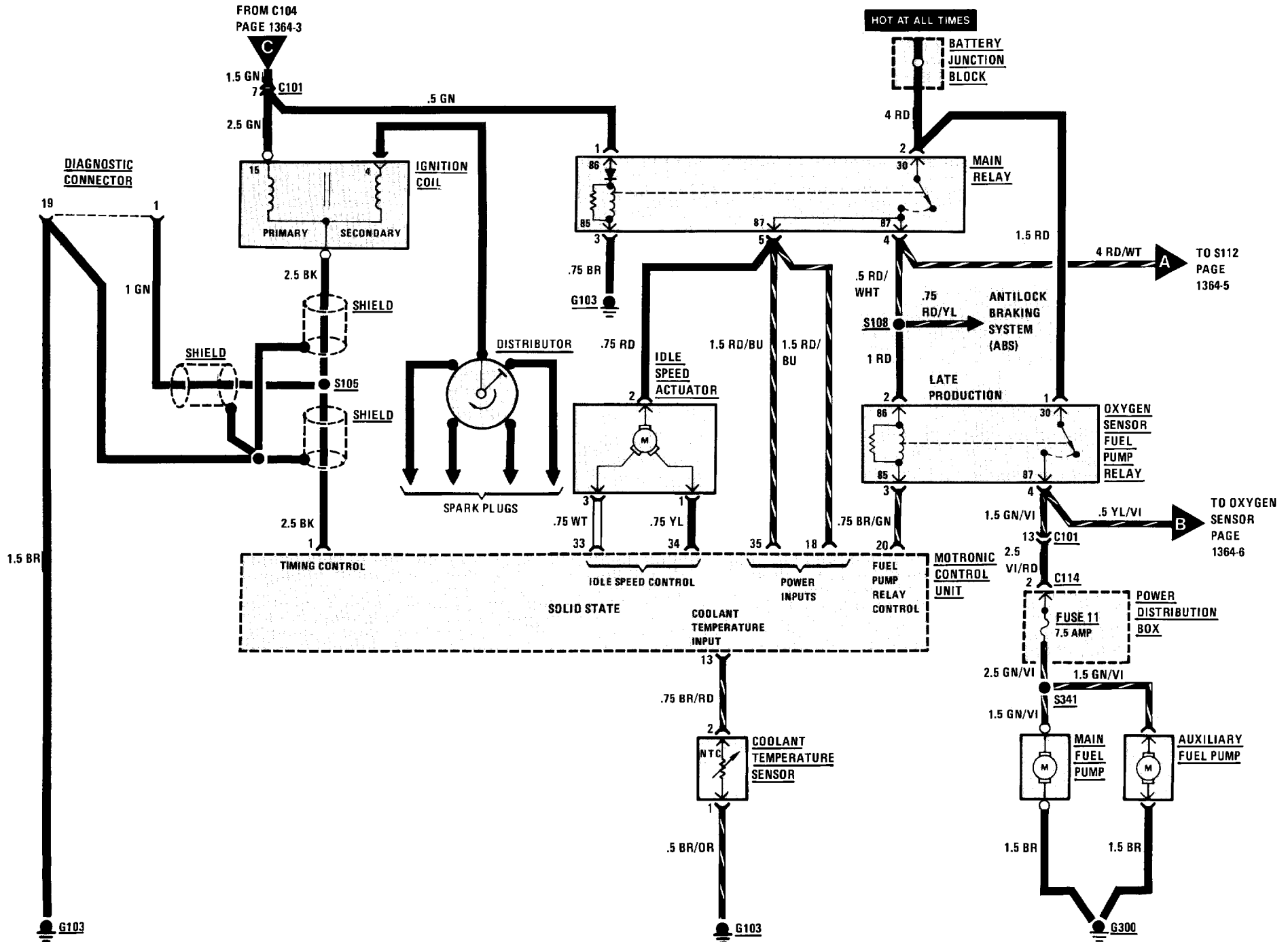

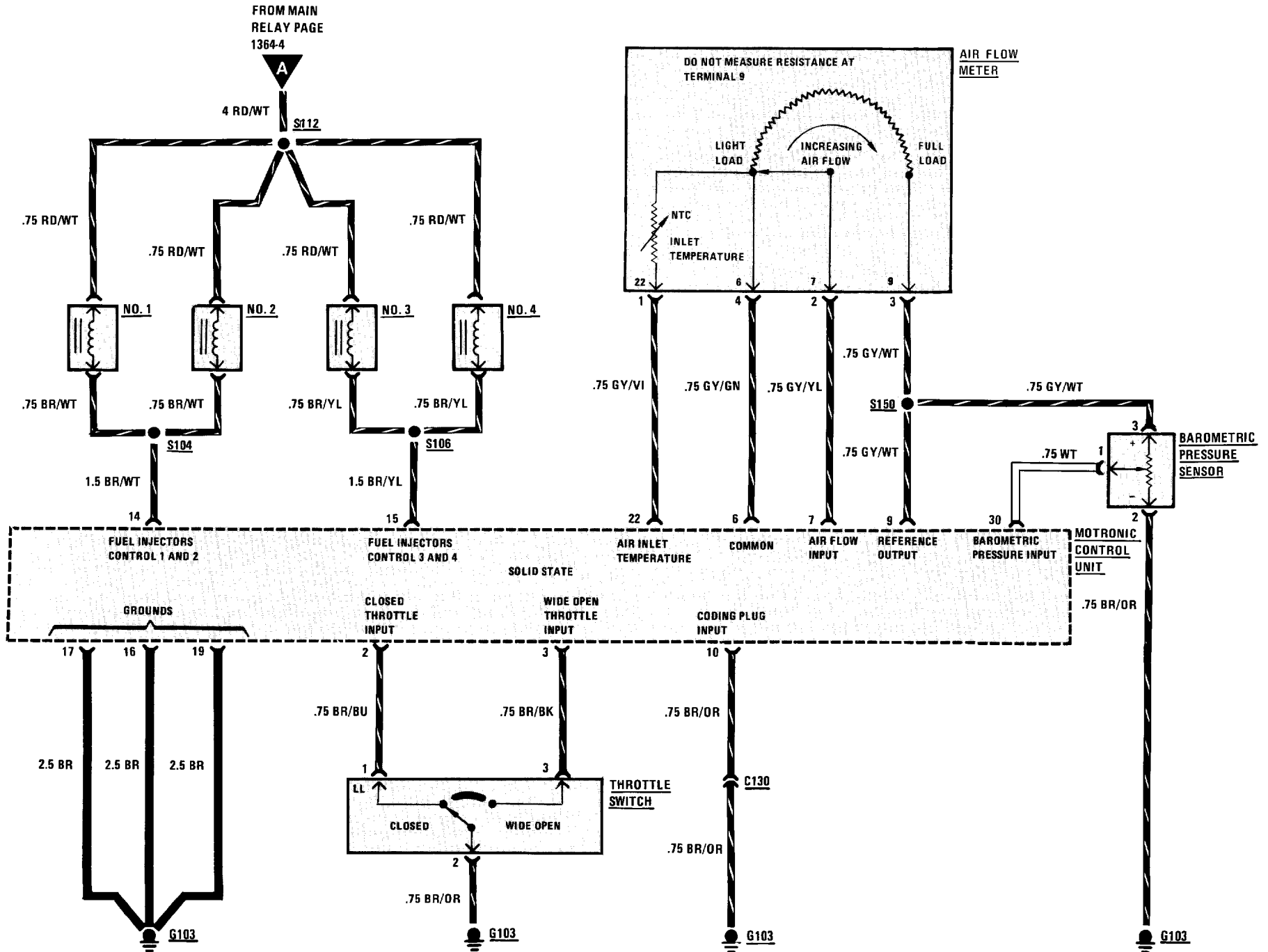

# 1364-6 INJECTION ELECTRONICS S14 ENGINE

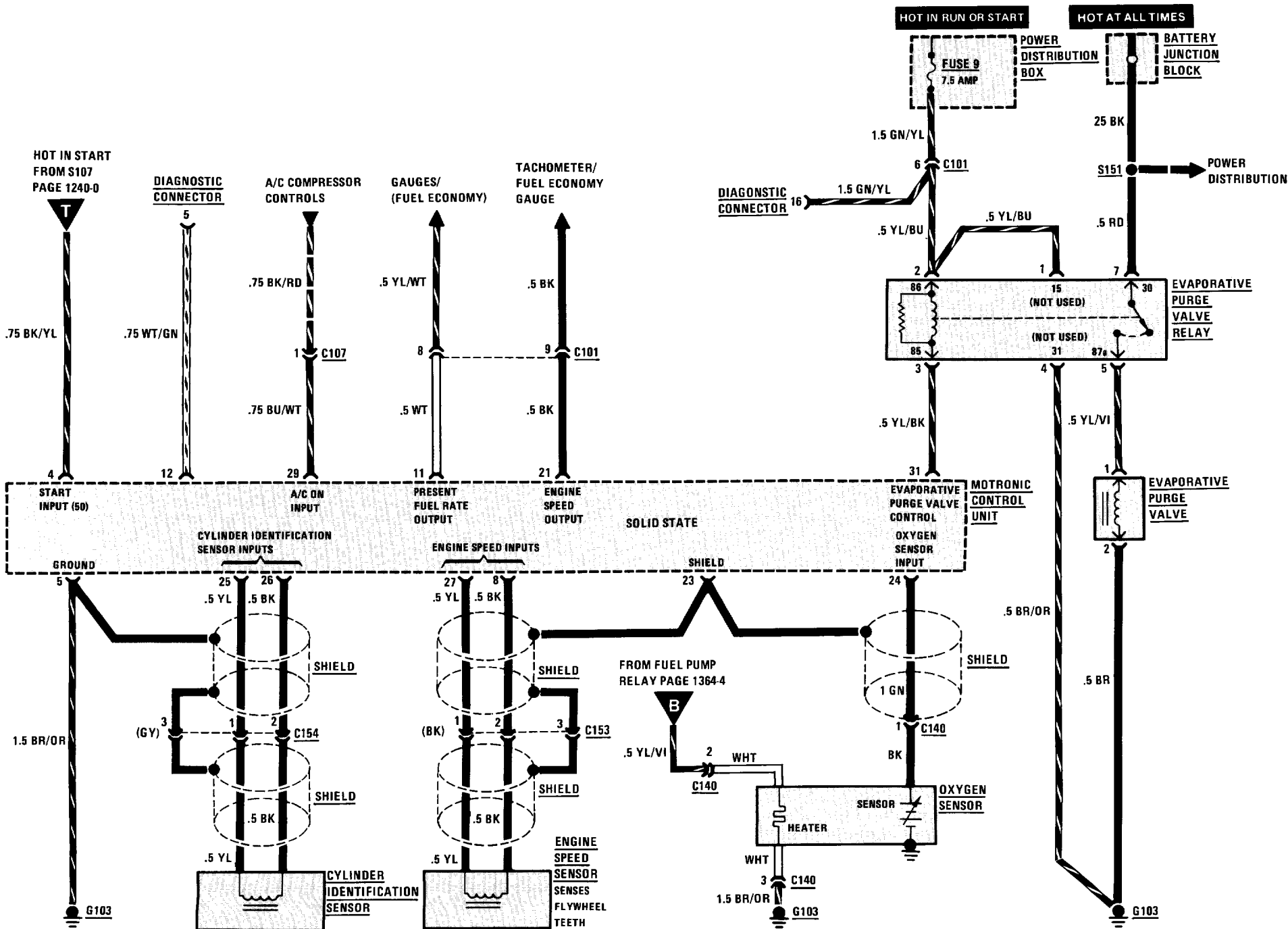

# 3435-0 BRAKE WARNING SYSTEM

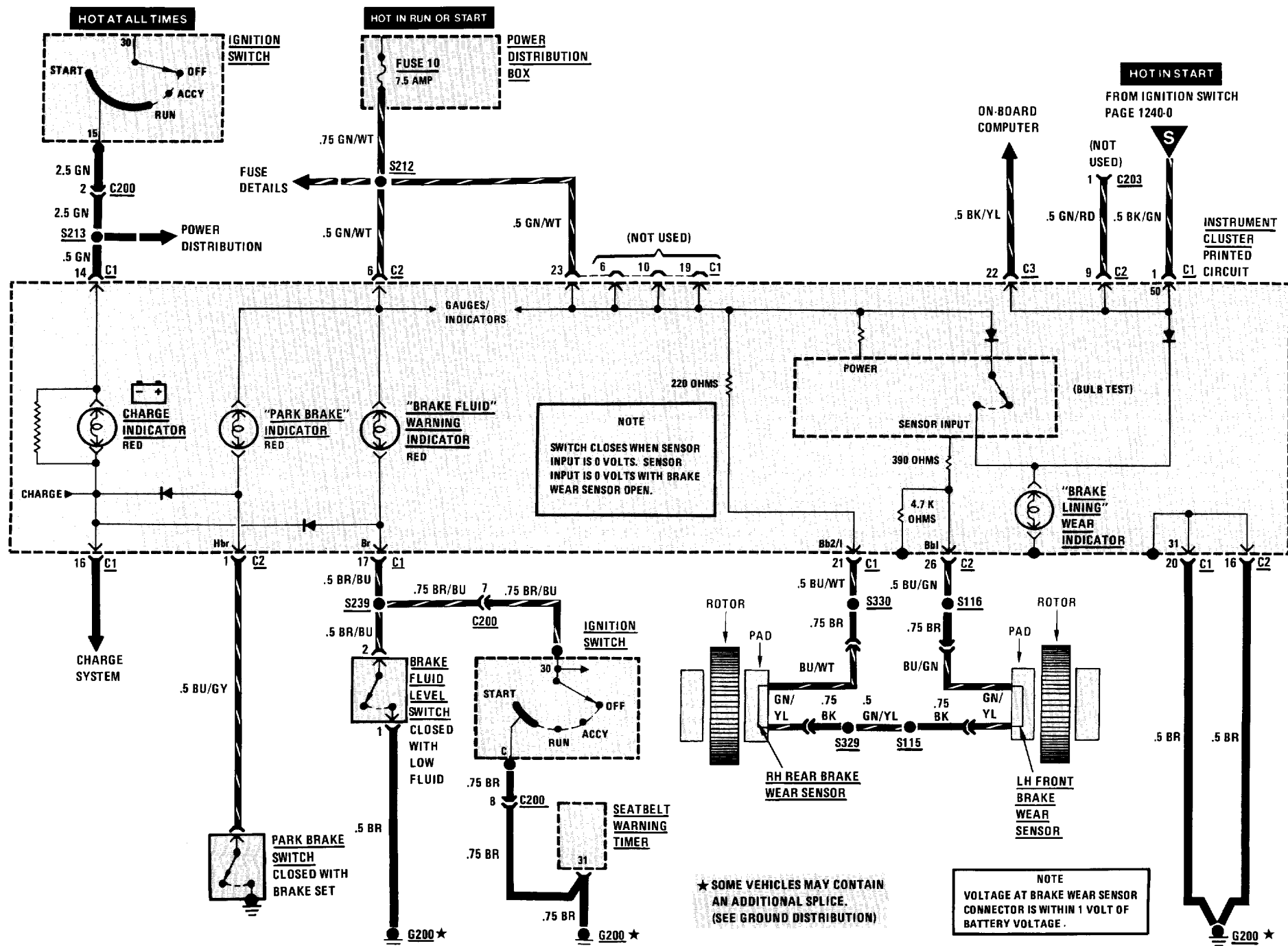



EARLY PRODUCTION

FROM OVER VOLTAGE  
PROTECTION RELAY  
PAGE 3450-0

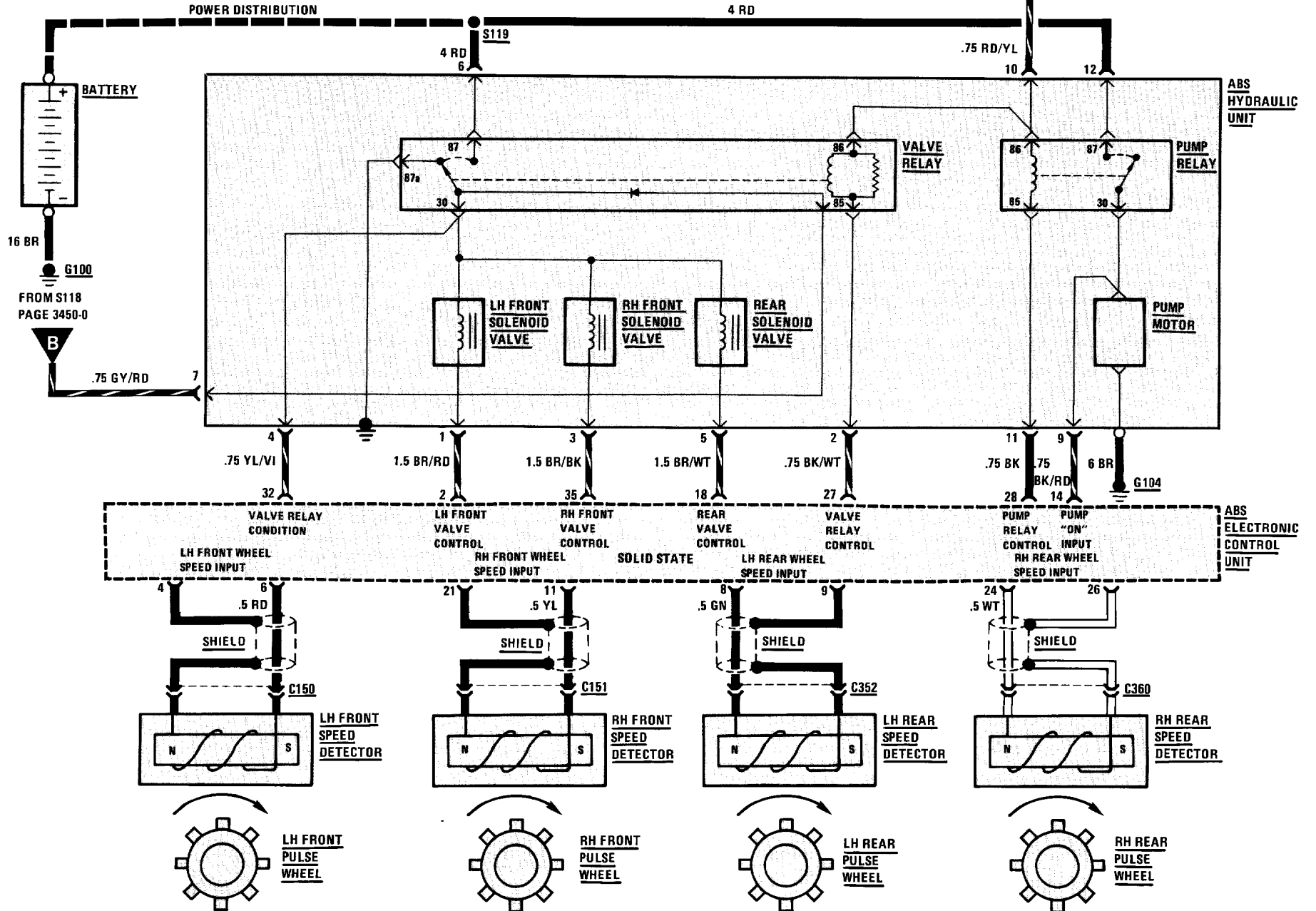

LATE PRODUCTION

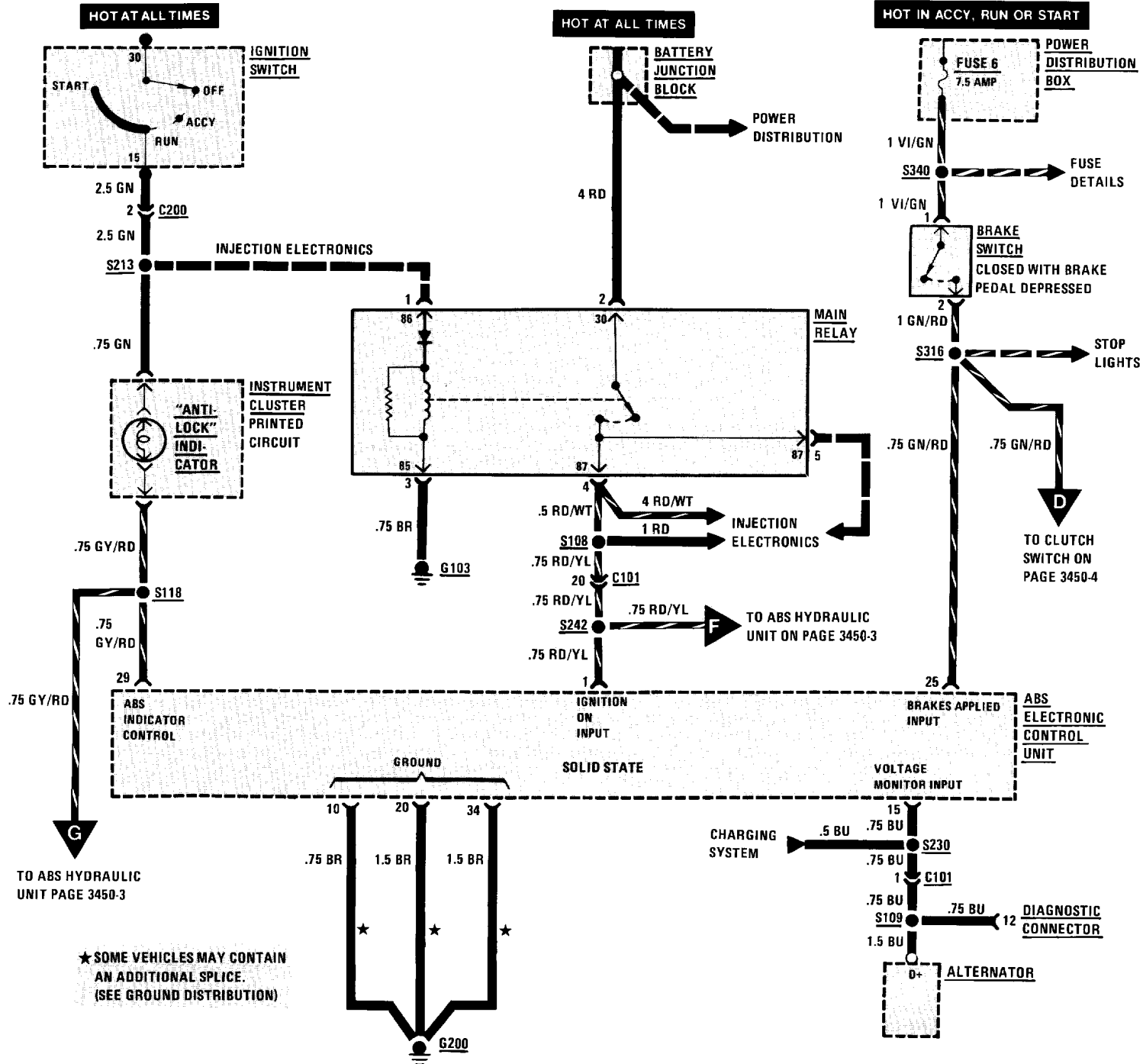

LATE PRODUCTION

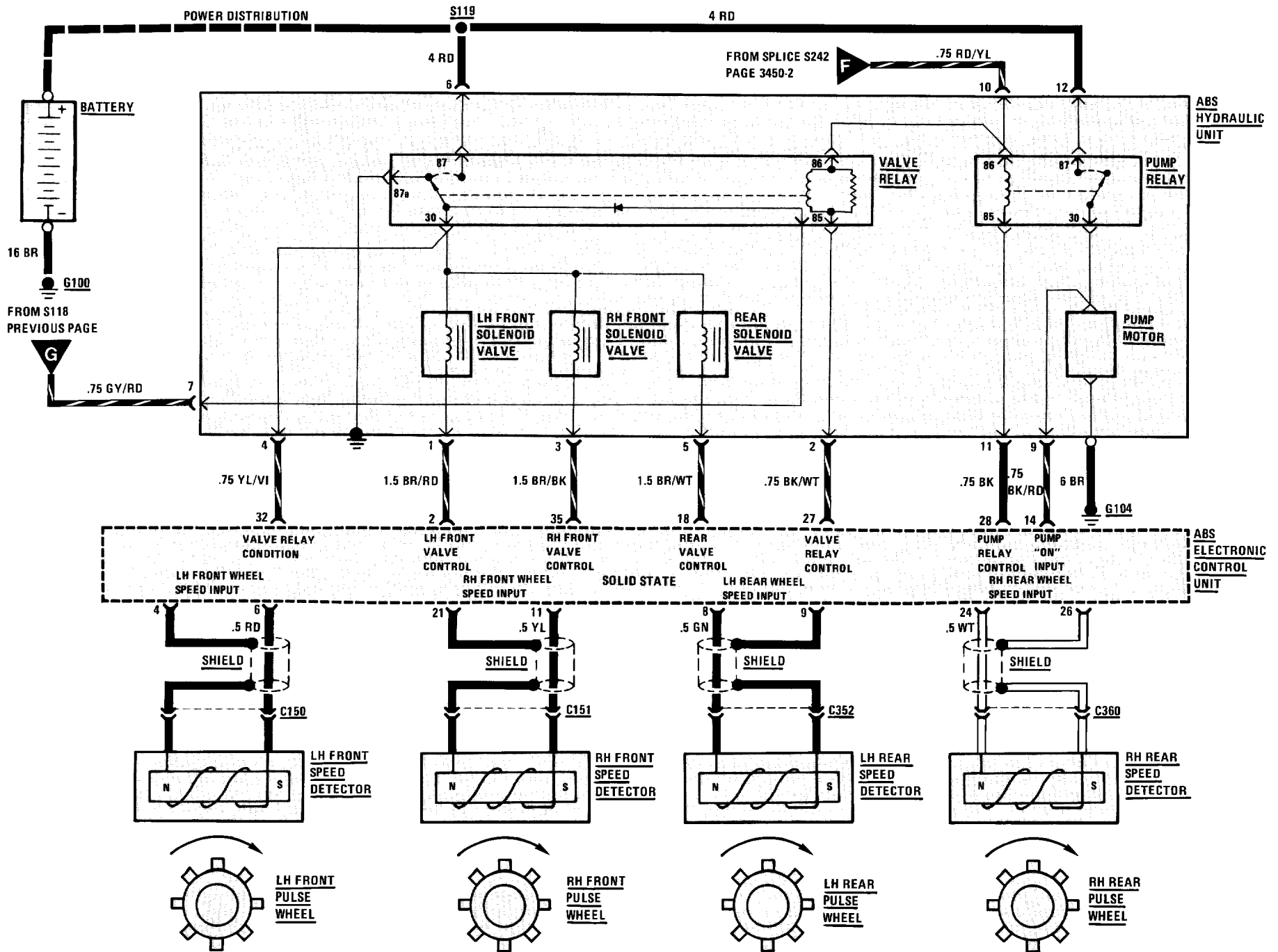



# 5116-0 POWER MIRRORS

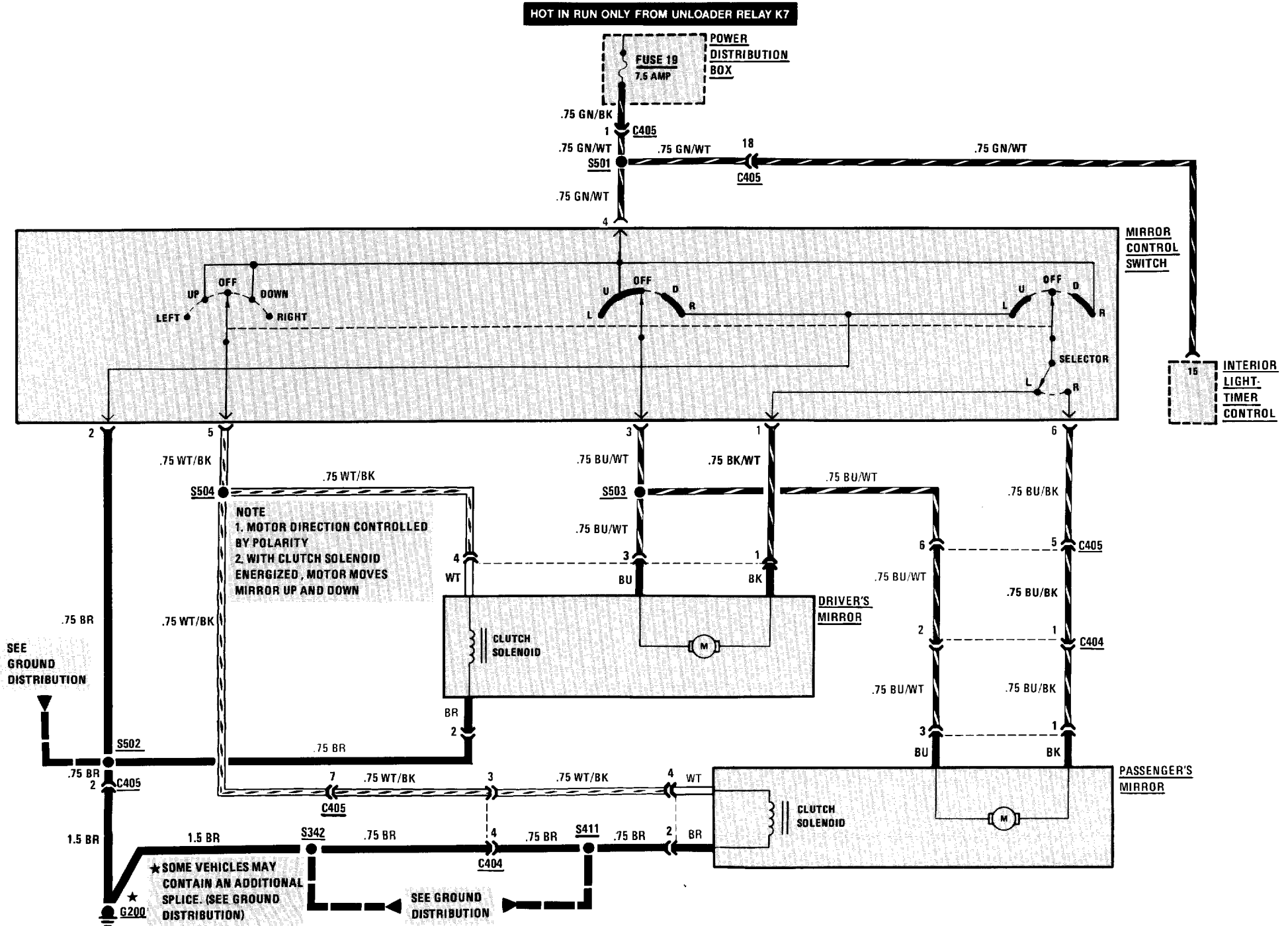

# 5126-0 CENTRAL LOCKING

## 2 DOOR (SELECT)

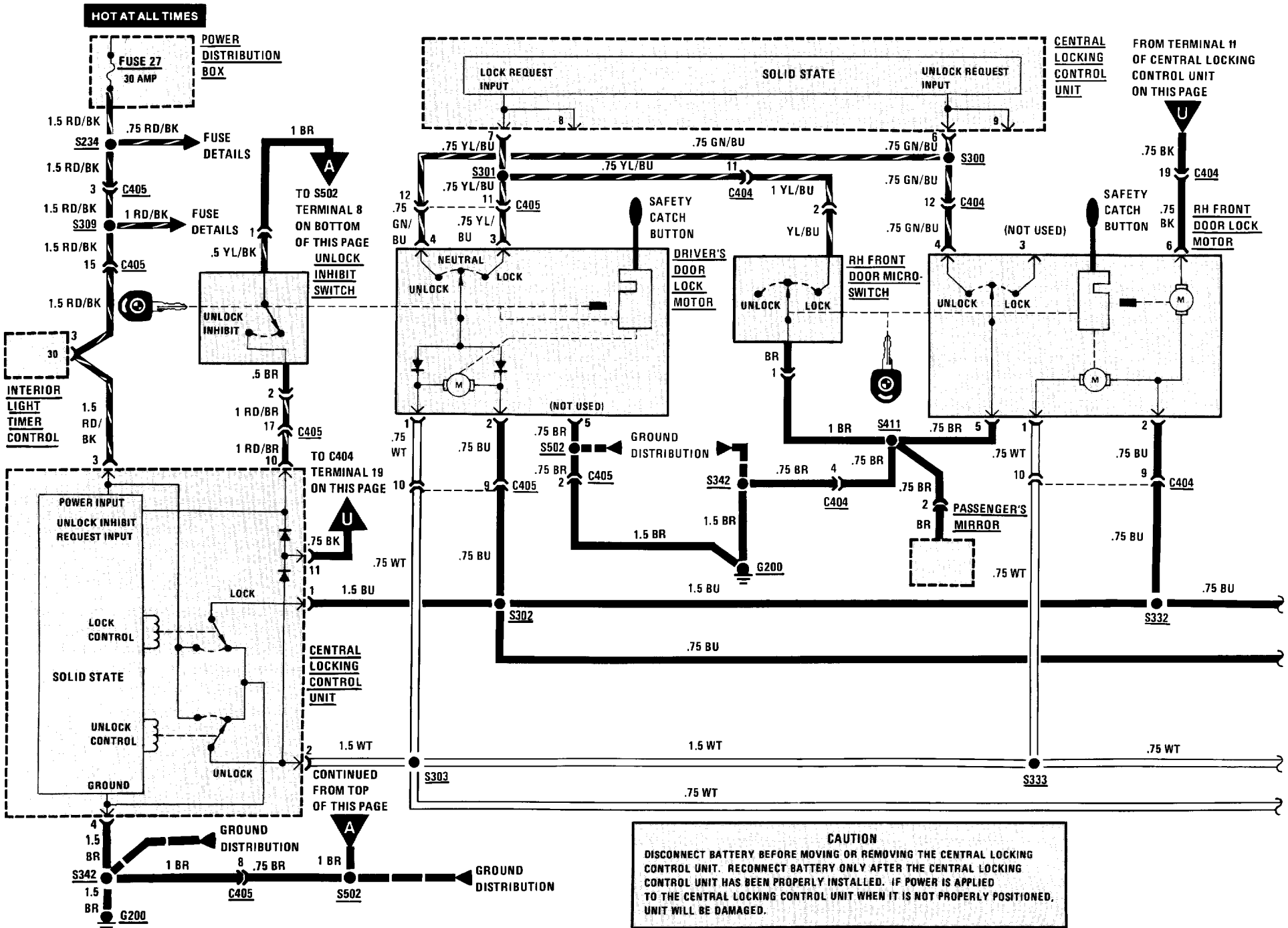

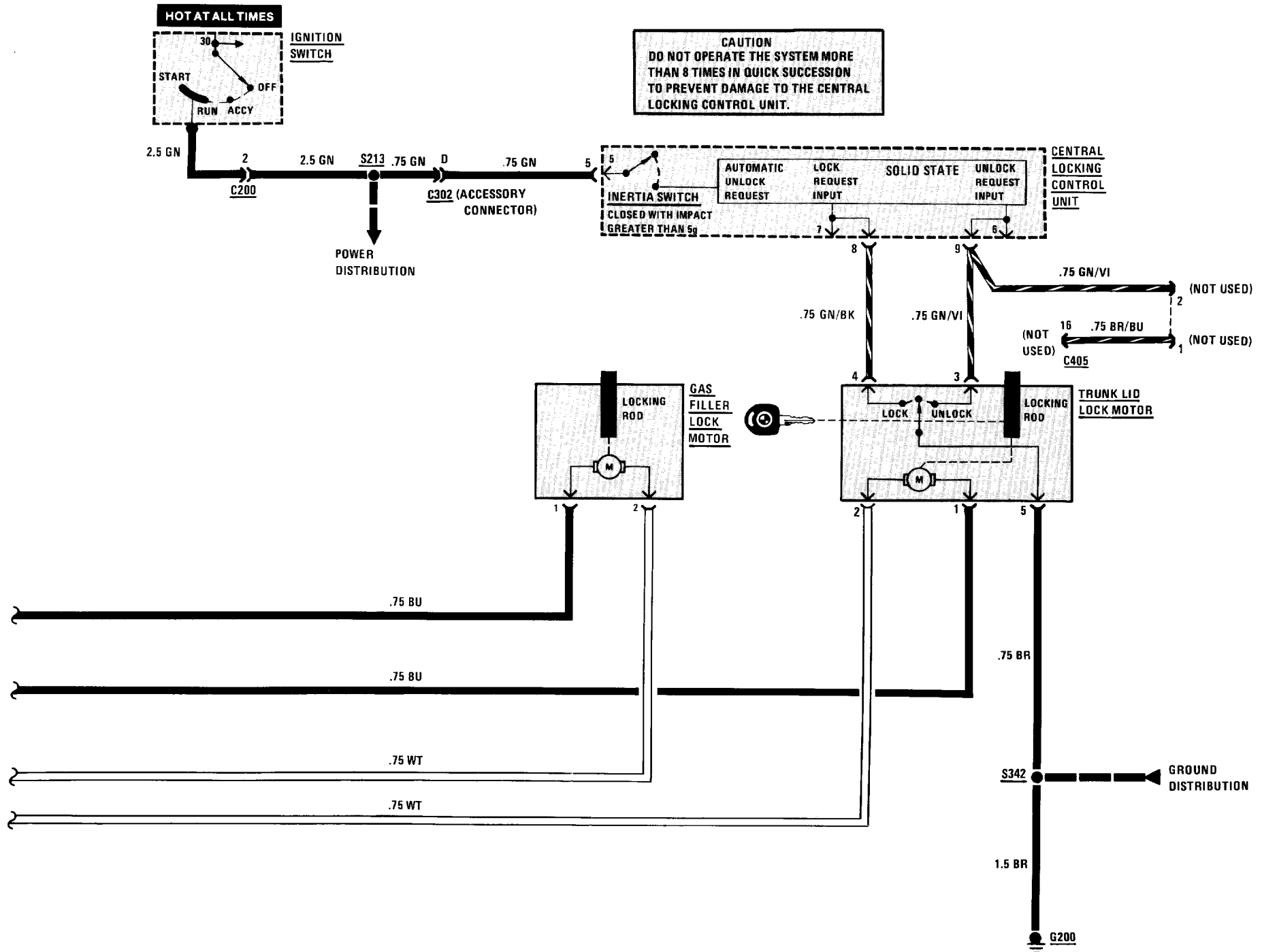

## 5126A-0 CENTRAL LOCKING

### TROUBLESHOOTING HINTS

1. Check Fuse by operating the Interior Light Timer for either Dome Light.
2. If all locks stay in UNLOCK INHIBIT, check the wires to terminal 10 of the Central Locking Control Unit for a short to ground.

### SYSTEM CHECK

- Operate controls in sequence listed in the System Check Table.
- Refer to Repair Action for the Response received (tests follow the System Check Table).
- After any repair, repeat System Check to verify proper system operation.

**NOTE:** Before replacing any system component, check all connectors, splices, and wiring to that component.

**SYSTEM CHECK TABLE**

OPERATION	RESPONSE	REPAIR ACTION
1. Insert the key in the Driver's door and turn to LOCK	All doors lock	None, proceed to Operation 2
	Some doors lock	Repair/replace the suspect Door Lock Motor circuit
	No doors lock	Proceed to Operation 4
2. Turn the key to UNLOCK INHIBIT (clockwise until key is horizontal)	All doors double lock (Safety Catch Buttons cannot be pulled up by hand)	None, proceed to Operation 3
	Driver's door double locks and only some of the other doors double lock	Repair/replace the suspect Door Lock Motor
	Driver's door double locks but no other doors double lock	Perform Test B
	Driver's door does not double lock	Mechanical problem, see BMW Workshop Manual

**SYSTEM CHECK TABLE (CONT'D)**

OPERATION	RESPONSE	REPAIR ACTION
3. Turn the key to UNLOCK	All doors unlock	None, proceed to Operation 4
	Some doors unlock	Repair/replace the suspect Door Lock Motor circuit
	No doors unlock	Proceed to Operation 5
4. Insert the key in the Passenger's door and turn to LOCK	All doors lock	If the doors did not lock in Operation 1, repair/replace the Driver's Door Lock Switch, otherwise proceed to Operation 5
	Some doors lock	Repair/replace the suspect Door Lock Motor circuit
	No doors lock	If all the doors locked in Operation 1, repair/replace the Right Front Door Microswitch. If the doors did not lock in Operation 1, perform Test A
5. Insert the key in the Passenger's door and turn to UNLOCK	All doors unlock	If all the doors did not unlock in Operation 3, repair/replace the Driver's Door Lock Switch, otherwise proceed to Operation 6
	Some doors unlock	Repair/replace the suspect Door Lock Motor
	No doors unlock	If all the doors unlocked in Operation 3, repair/replace the Passenger's Door Lock Switch. If the doors did not unlock in Operation 3, perform Test C
6. Get in the car and close and lock all doors Turn the Ignition Switch to RUN	Doors remain locked	None, proceed to Operation 7
	Doors unlock	Repair/replace the Central Locking Control Unit
7. Get out of the car Insert the key in the Driver's door and turn to LOCK Unlock each of the doors by pulling up the Safety Catch Buttons	All doors can be unlocked	None, proceed to Operation 8
	All doors remain secure	Disconnect the connector from the Central Locking Control Unit and check for a short to ground in the wires at terminal 11. <ul style="list-style-type: none"> <li>• If short to ground is not present, replace the Central Locking Control Unit</li> <li>• If short to ground is present isolate wiring from Door Lock Motors one at a time to find short</li> </ul>

## 5126A-2 CENTRAL LOCKING

### SYSTEM CHECK TABLE (CONT'D)

OPERATION	RESPONSE	REPAIR ACTION
8. Insert the key in the Trunk Cylinder Switch. Turn the key to LOCK	Trunk locks	None, proceed to Operation 9
	Trunk does not lock	If the doors lock, repair/replace the Trunk Lock Motor Circuit or Trunk Lock Motor If the doors do not lock, repair/replace the Trunk Switch Repair/replace the Central Locking Control Unit if the Trunk Switch Circuit is OK
9. Turn the key to UNLOCK	Trunk unlocks	None, proceed to Operation 10
	Trunk does not unlock	If the doors unlock, repair/replace the Trunk Lock Motor circuit or Trunk Lock Motor If the doors do not unlock, repair/replace the Trunk Switch Repair/replace the Central Locking Control Unit if the Trunk Switch Circuit is OK
10. Turn the key back to LOCK	Gas Filler locks	None, proceed to Operation 11
	Gas Filler does not lock	Repair/replace the Gas Filler Lock Motor circuit
11. Turn the key to UNLOCK	Gas Filler unlocks	None
	Gas Filler does not unlock	Repair/replace the Gas Filler Lock Motor circuit

- If all results are normal, the system is OK.

### SYSTEM DIAGNOSIS

- Do the following tests when directed by the System Check Table.

#### A: CONTROL UNIT LOCK TEST (TABLE 1)

Measure: VOLTAGE At: CONTROL UNIT CONNECTOR (Connected)		
Measure Between	Correct Voltage	For Diagnosis
3 & Ground	Battery	See 1
3 & 4	Battery	See 2
<ul style="list-style-type: none"> <li>• If the voltages are correct, proceed to Table 2.</li> </ul> <ol style="list-style-type: none"> <li>1. Check the wire to terminal 3 for an open.</li> <li>2. Check the wire from terminal 4 for an open to ground (see schematic).</li> </ol>		

#### A: CONTROL UNIT LOCK TEST (TABLE 2)

Connect: A FUSED JUMPER At: CONTROL UNIT CONNECTOR (Connected)		
Jumper Between	Correct Result	For Diagnosis
7 & Ground	Doors lock	See 1
<ul style="list-style-type: none"> <li>• If the result is correct, repair/replace the switches and related wiring (see schematic).</li> </ul> <ol style="list-style-type: none"> <li>1. Proceed to Table 3.</li> </ol>		

**A: CONTROL UNIT LOCK TEST  
(TABLE 3)**

Connect: FUSED JUMPERS At: CONTROL UNIT CONNECTOR (Disconnected)		
Jumper Between	Correct Result	For Diagnosis
1 & 3 2 & 4	Doors lock	See 1
<ul style="list-style-type: none"> <li>If the result is correct, replace the Central Locking Control Unit.</li> </ul> <ol style="list-style-type: none"> <li>Check the wire from terminal 1 to splice and the wire from terminal 3 to splice for opens (see schematic).</li> </ol>		

**B: UNLOCK INHIBIT TEST**

Connect: A FUSED JUMPER At: CONTROL UNIT CONNECTOR (Connected)		
Jumper Between	Correct Result	For Diagnosis
10 & Ground	Doors double lock	See 1
<ul style="list-style-type: none"> <li>If the result is correct, check the wires from terminal 10 to ground for opens (see schematic). Replace the Unlock Inhibit Switch if the wires and connections are OK.</li> </ul> <ol style="list-style-type: none"> <li>Check the wires from terminal 11 for opens (see schematic). Replace the Central Locking Control Unit, if the wires and connections are OK.</li> </ol>		

**C: CONTROL UNIT UNLOCK TEST**

Connect: A FUSED JUMPER At: CONTROL UNIT CONNECTOR (Connected)		
Jumper Between	Correct Result	For Diagnosis
6 & Ground	Doors unlock	See 1
<ul style="list-style-type: none"> <li>If the result is correct, repair/replace the switches and related wiring (see schematic).</li> </ul> <ol style="list-style-type: none"> <li>Replace the Central Locking Control Unit.</li> </ol>		

**CIRCUIT DESCRIPTION**

The Central Locking System is controlled by the Central Locking Control Unit. This unit senses when a lock switch is moved by a key, and sends the appropriate signal to drive the Motors. The Central Locking Control Unit controls the Door Locks, Gas Filler Lock and Trunk Lock. The unit also has an Inertia Switch which closes on impact greater than 5g. If in RUN or START the locks are then unlocked.

**Lock**

When the Key is inserted into a lock and turned clockwise, the Lock switch moves to LOCK and grounds terminal 7 of the Central Locking Control Unit. The unit then activates the Lock Relay and applies voltage from Fuse 27 to the Lock Motor, which is grounded through the Central Locking Control Unit terminal 2. The Lock Motor then pulls the lock down. The door locks also control the Trunk Lock and Gas Filler Lock.

**Unlock**

When the key is turned counterclockwise, terminal 6 of the Central Locking Control Unit is grounded through the Lock Switch. The Central Locking Control Unit then activates the Unlock Relay and applies voltage from Fuse 27, through terminal 2 to the Lock Motor. The motor is grounded through the Central Locking Control Unit terminal 1. The polarity is reversed and the motor pushes the lock up.

**Unlock Inhibit**

When the key is inserted into the Driver's Lock and turned clockwise past the LOCK position, the Unlock Inhibit mechanism is engaged. This mechanically inserts a bar into the driver's lock and prevents unlocking through use of the Safety Catch Button. When in the Unlock Inhibit position, ground is applied to the Unlock Inhibit motors in the other lock units. The Central Locking Control Unit is grounded at terminal 10 and then activates the Lock Relay. Voltage is applied to the Unlock Inhibit motors through terminal 1. They are now activated and engage the other Unlock Inhibit mechanisms. The direction of the motors is reversed when the doors are unlocked (see Unlock).

**Trunk Lock**

The Trunk Lock operates in a manner similar to the Door Locks.

# 5133-0 POWER WINDOWS

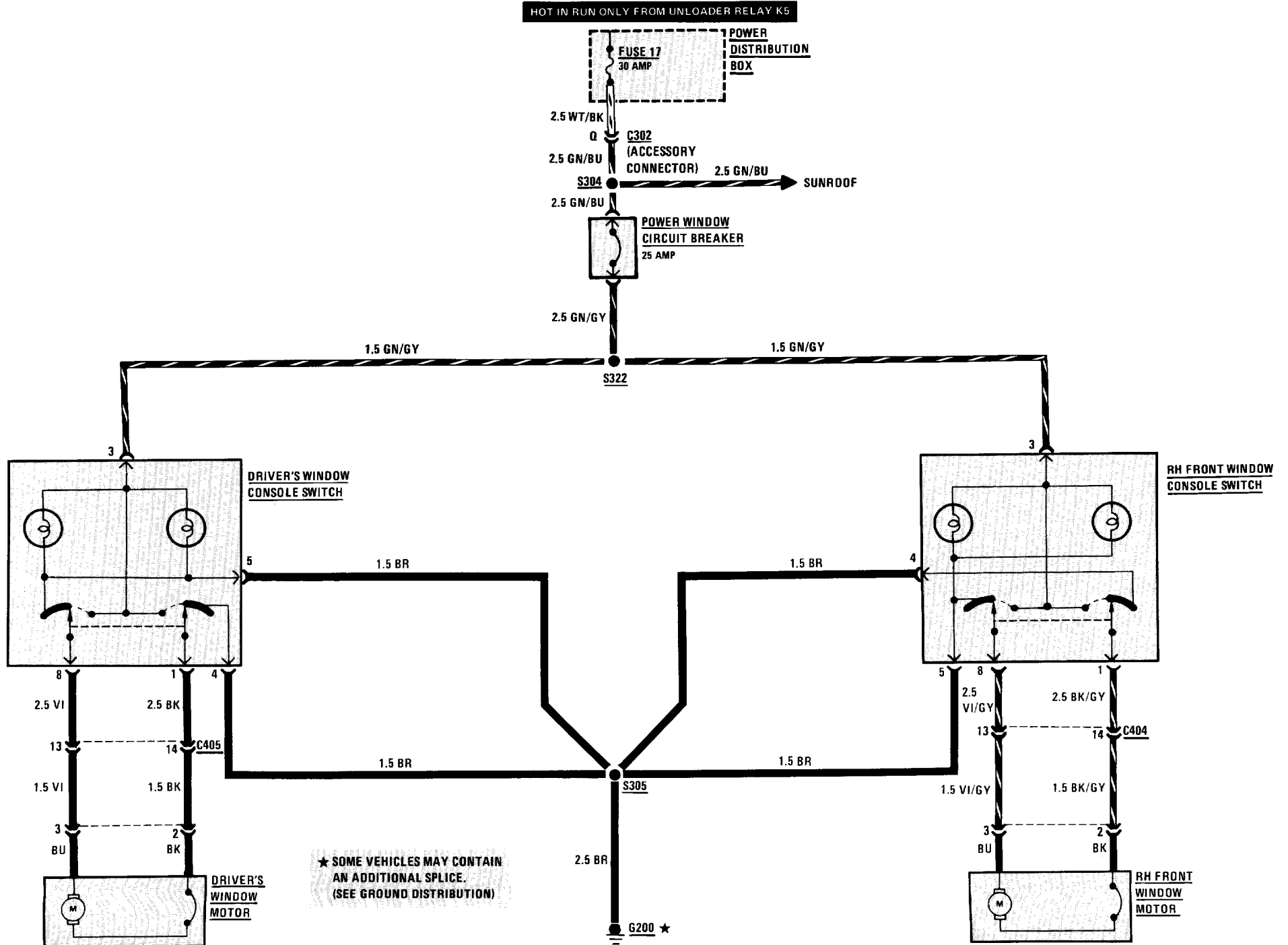



# 5413-0 SUNROOF

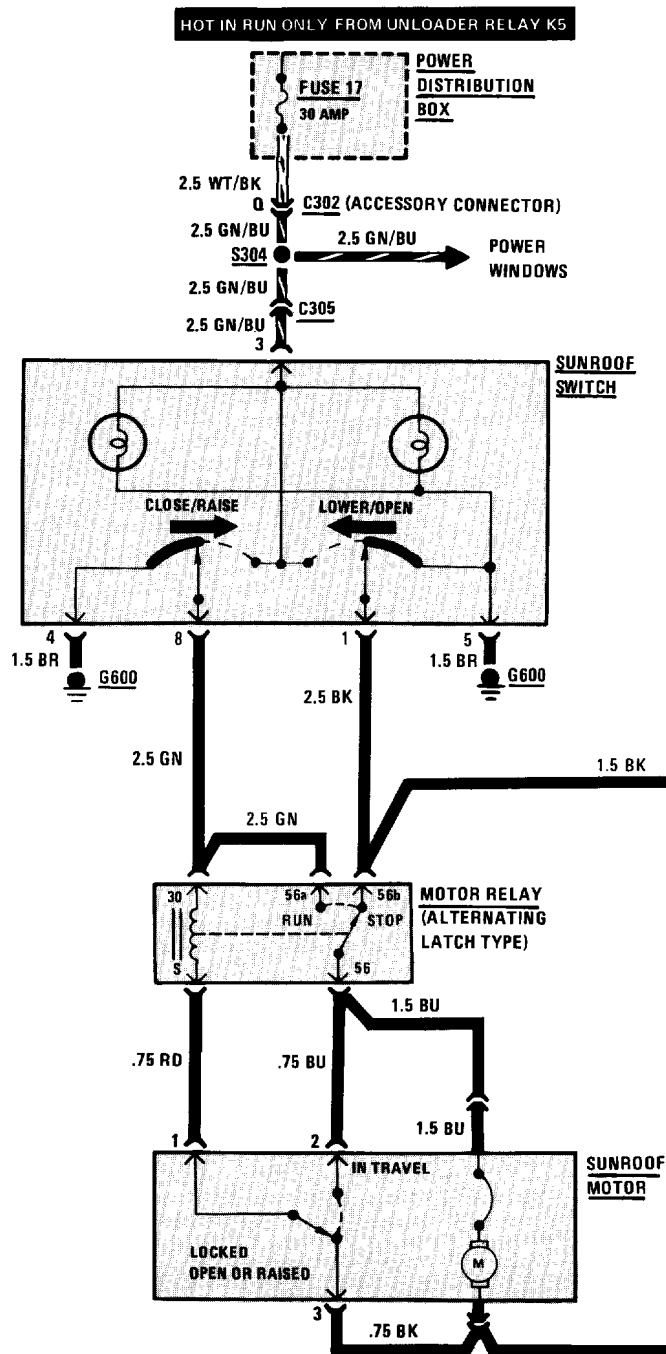

# 6100-0 BODY ELECTRICAL

## HORNS

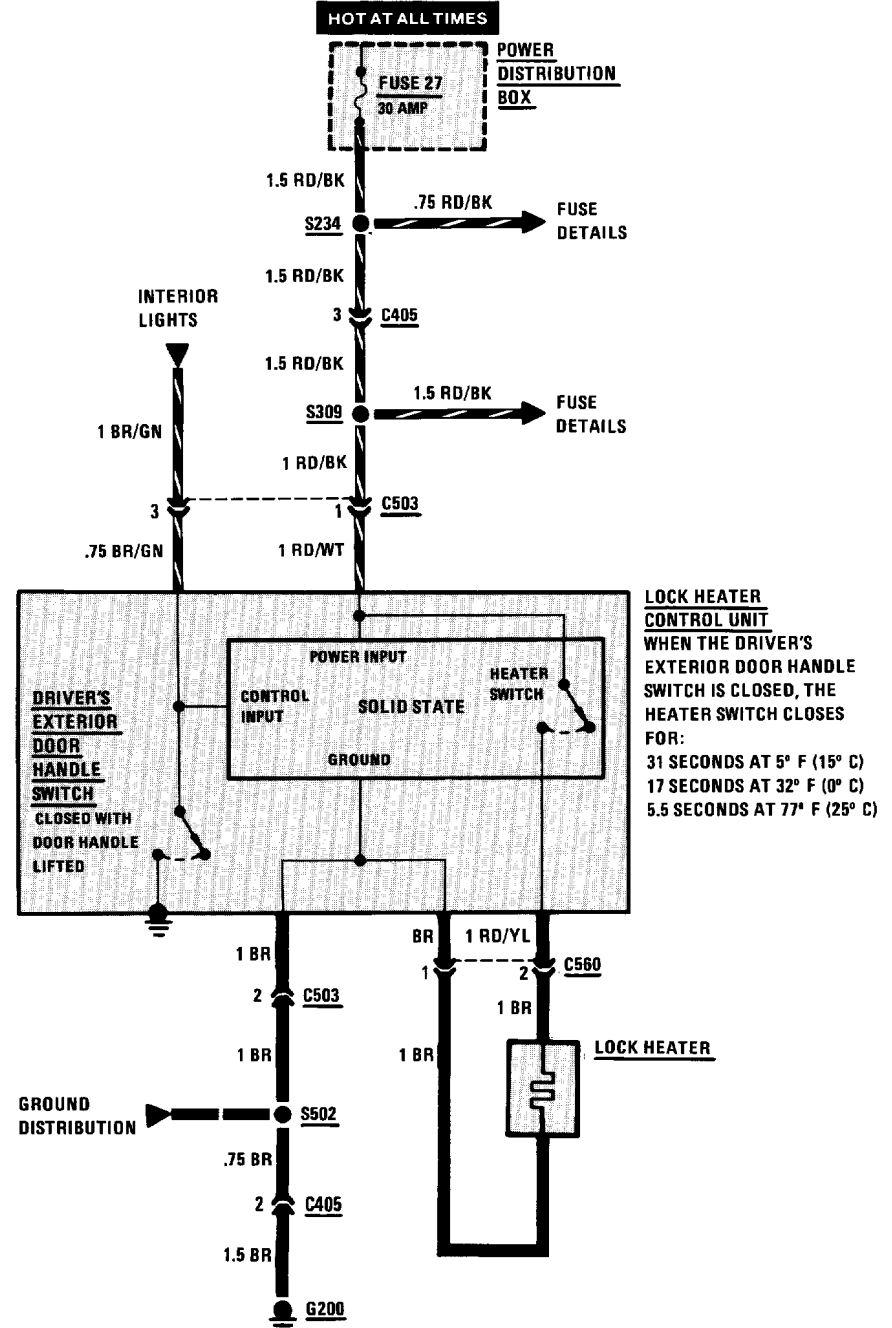
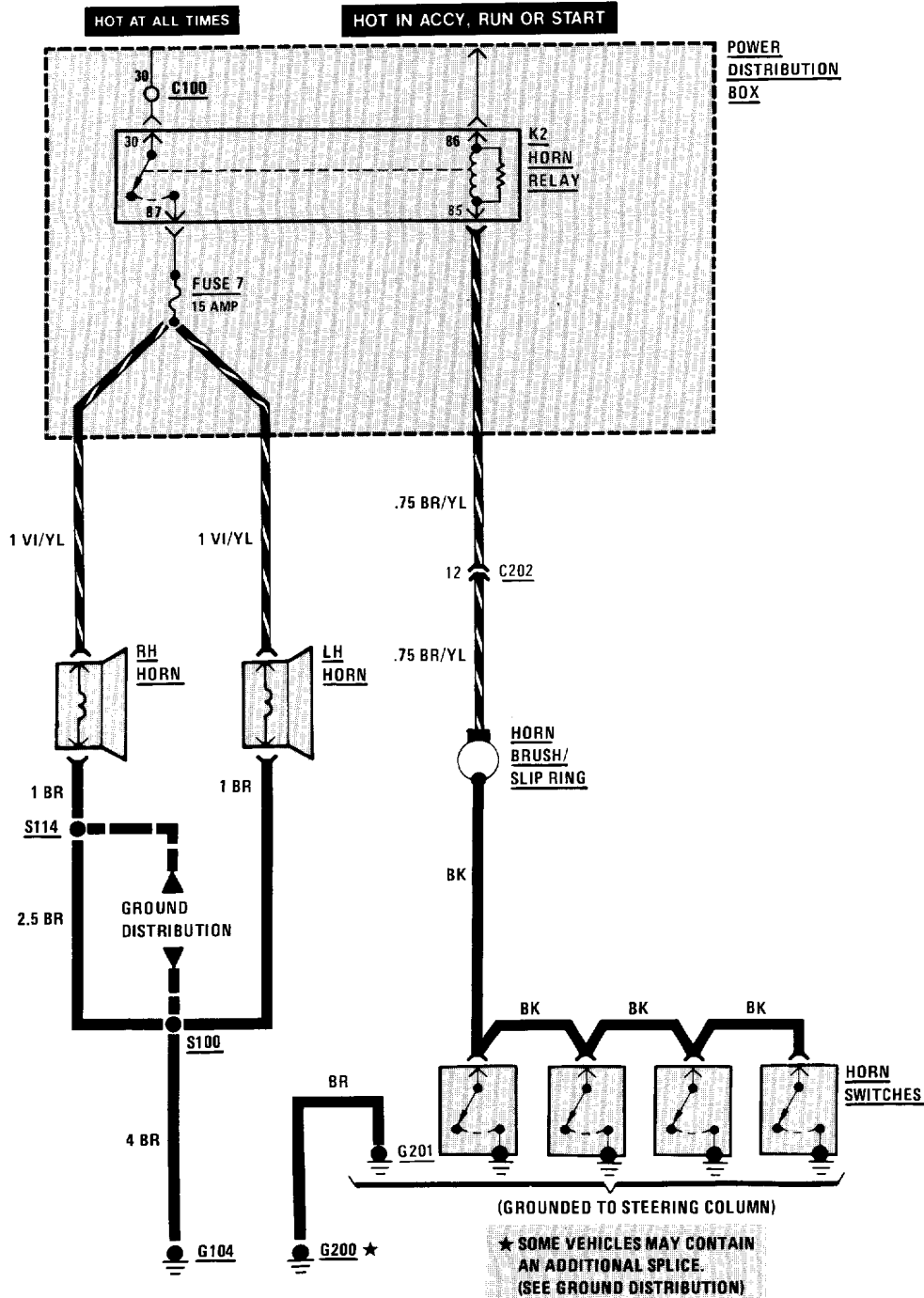

**CIGAR LIGHTER/GLOVE BOX LIGHT/AUTO-CHARGING FLASHLIGHT/MAP READING LIGHT**

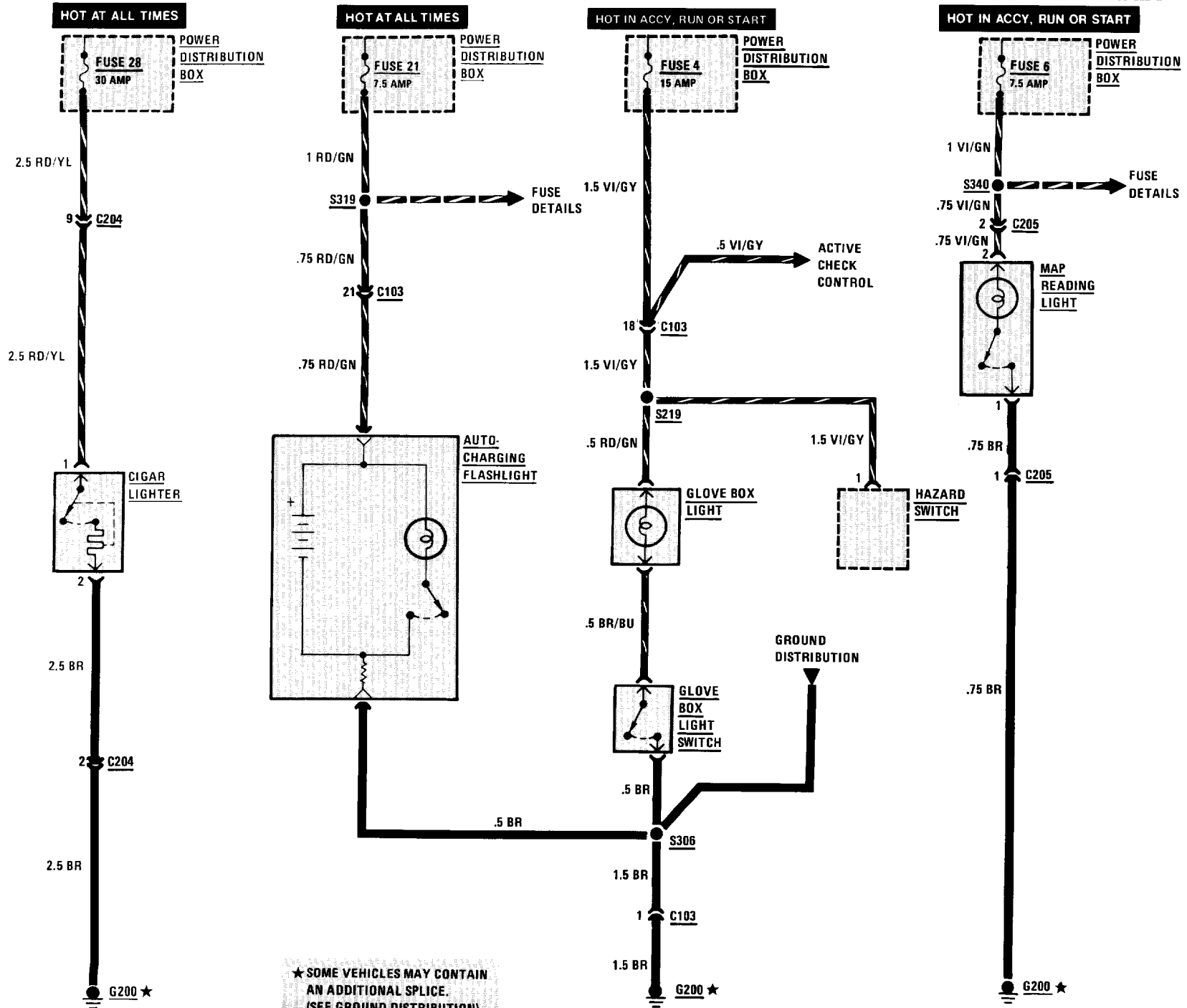

★ SOME VEHICLES MAY CONTAIN AN ADDITIONAL SPLICE. (SEE GROUND DISTRIBUTION)

REAR DEFOGGER

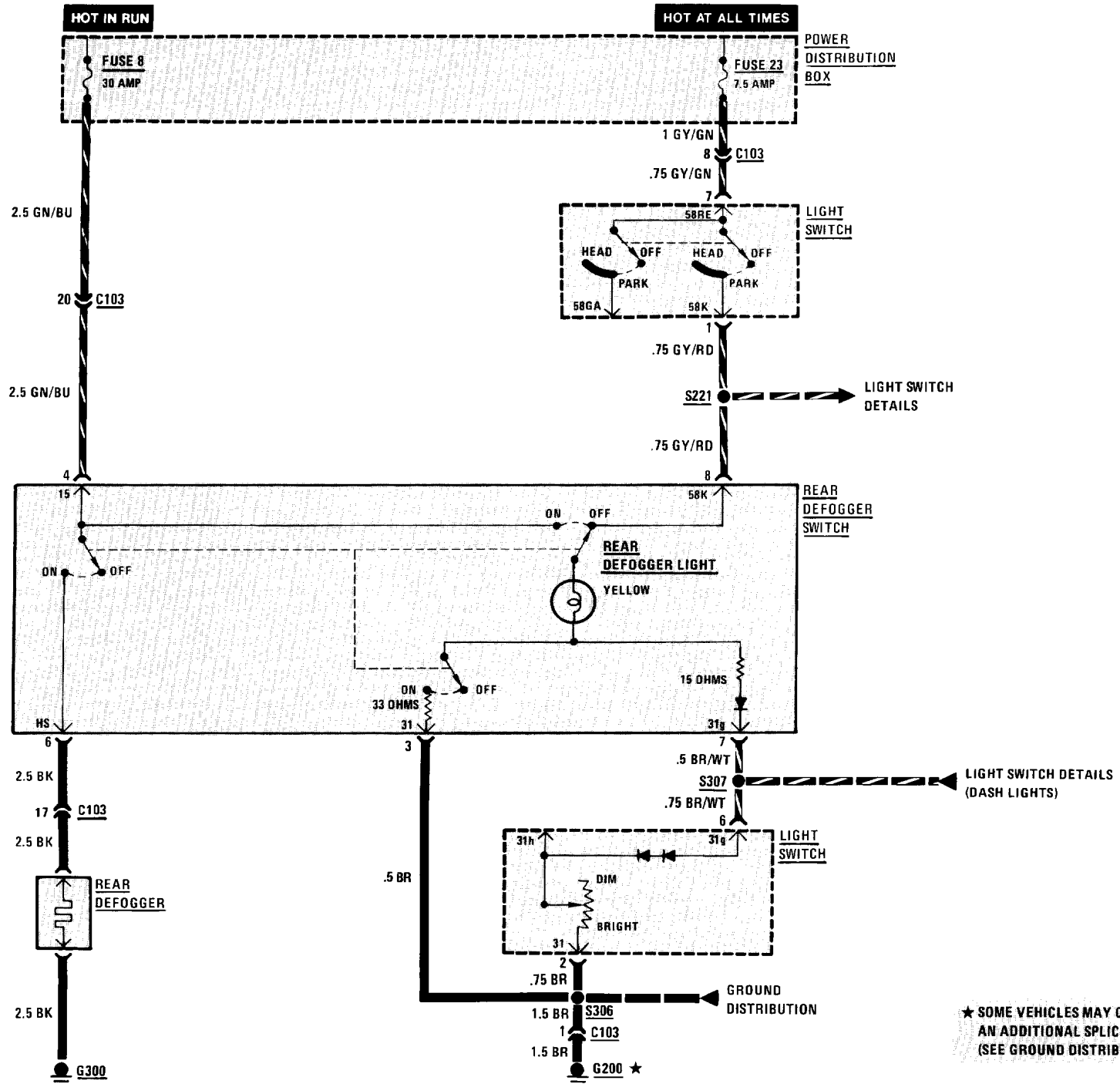

★ SOME VEHICLES MAY CONTAIN AN ADDITIONAL SPLICE. (SEE GROUND DISTRIBUTION)

# 6131-0 IGNITION KEY WARNING/SEATBELT WARNING

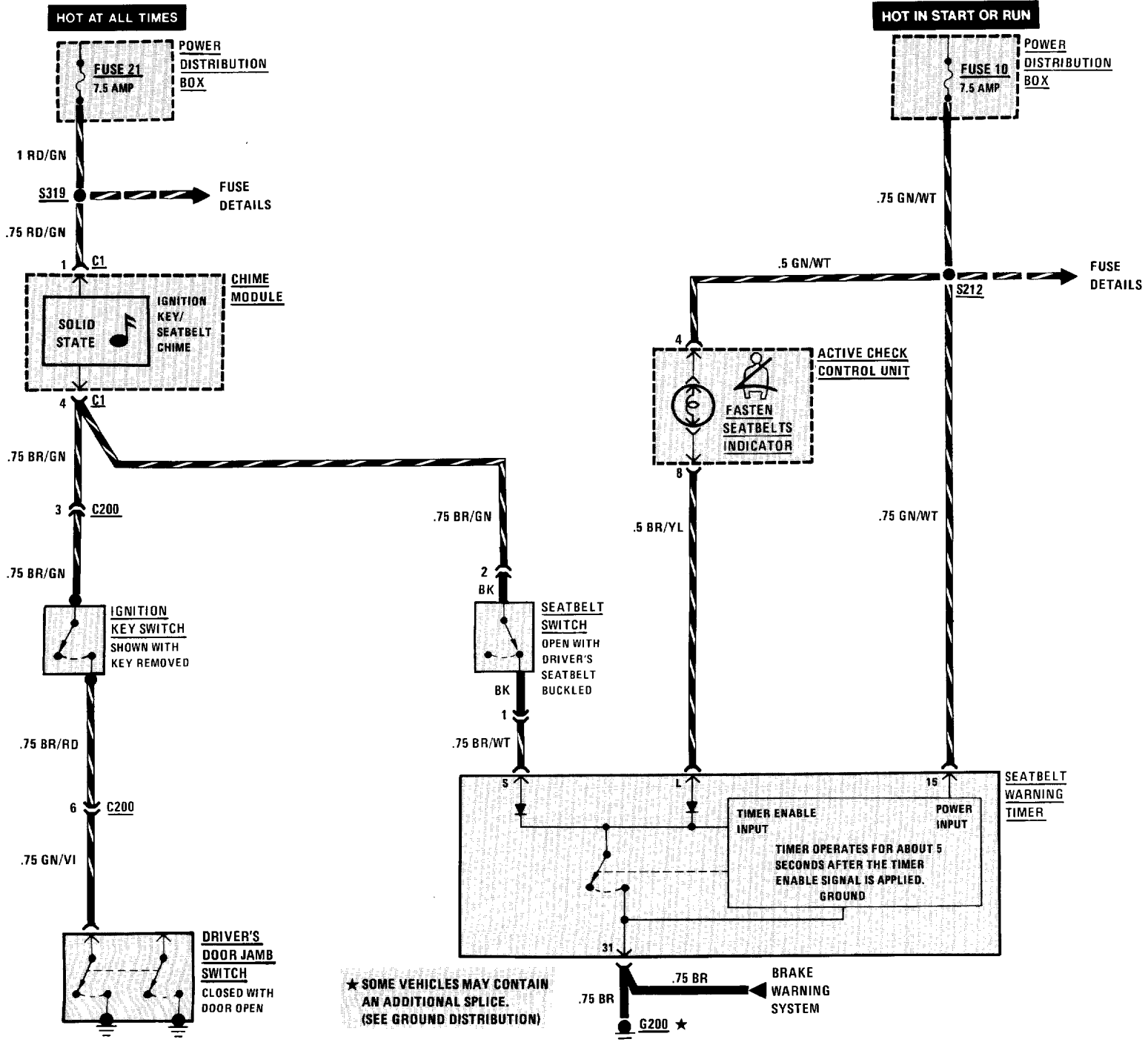

# 6160-0 WIPER/WASHER

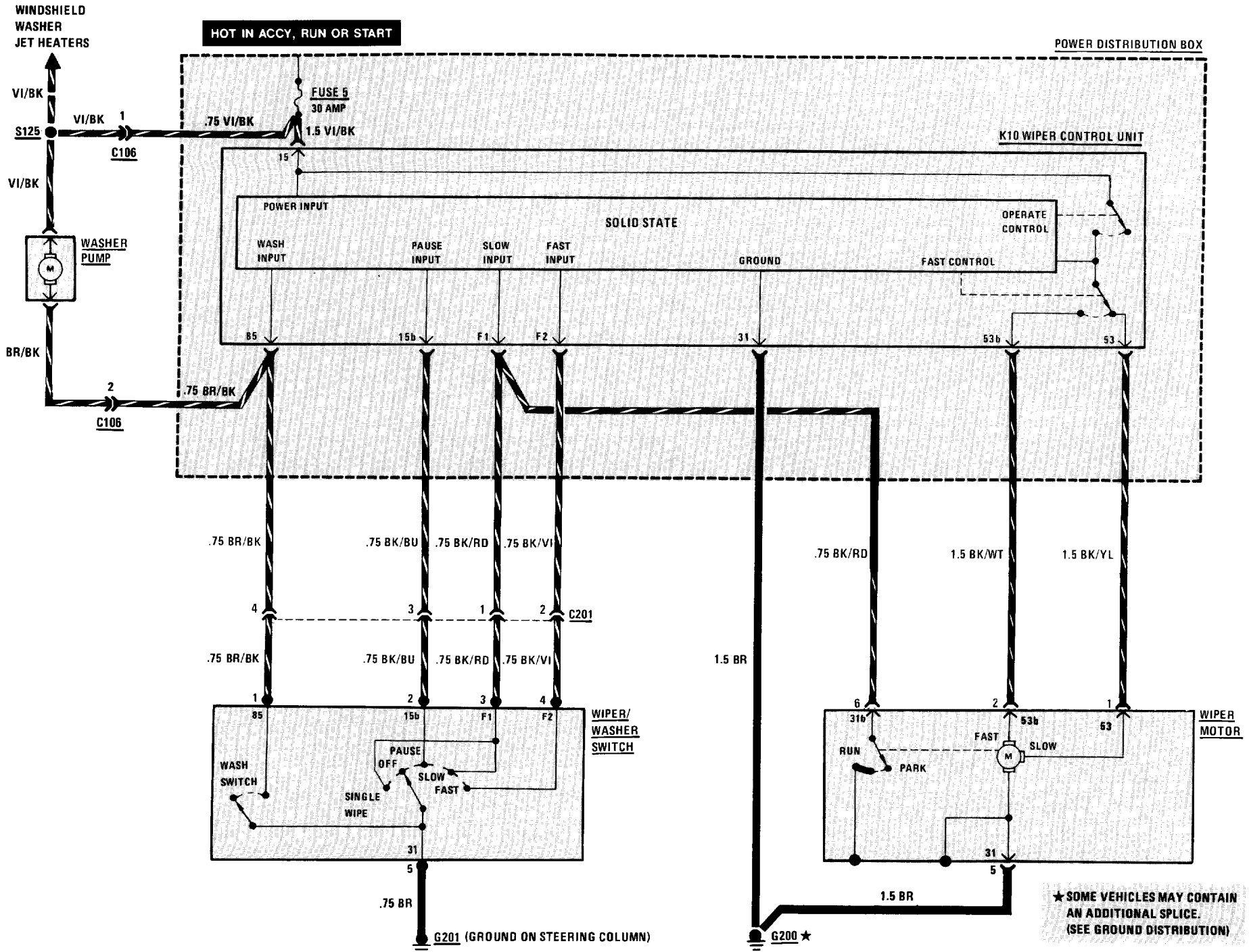

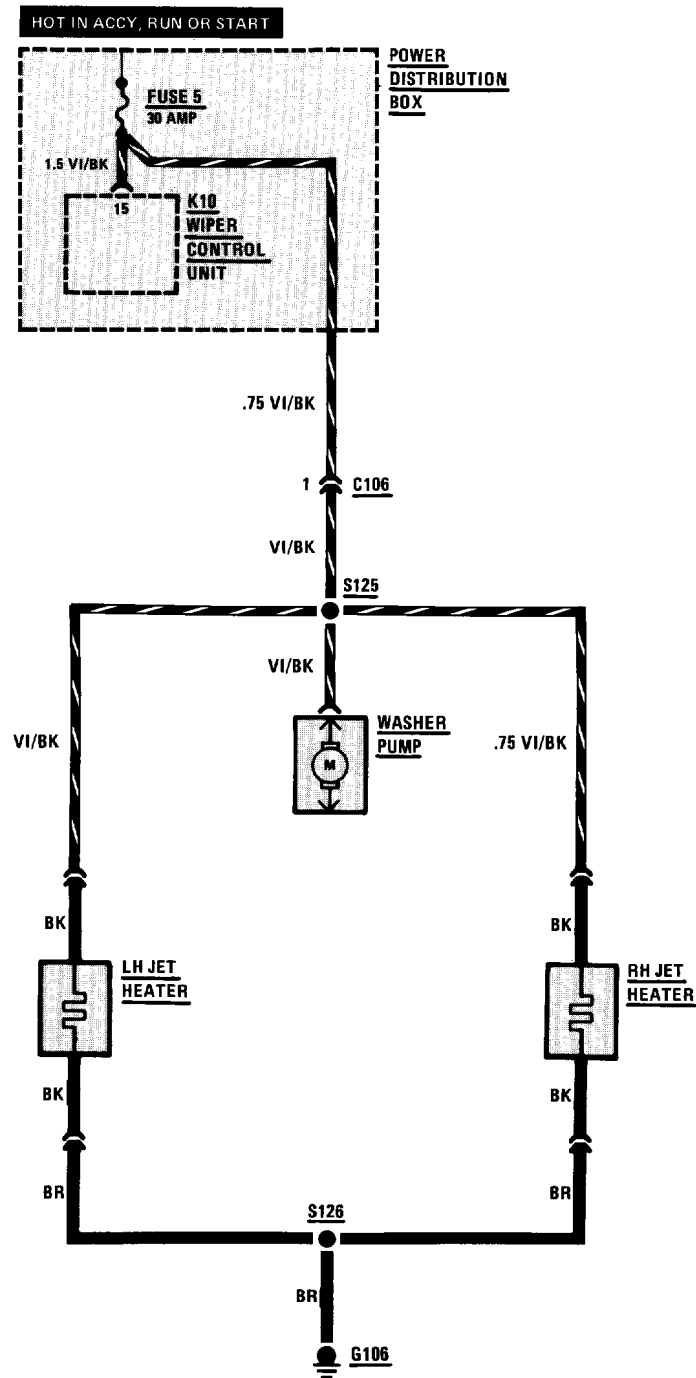

# 6210-0 INSTRUMENT CLUSTER

## SPEEDOMETER/INDICATORS

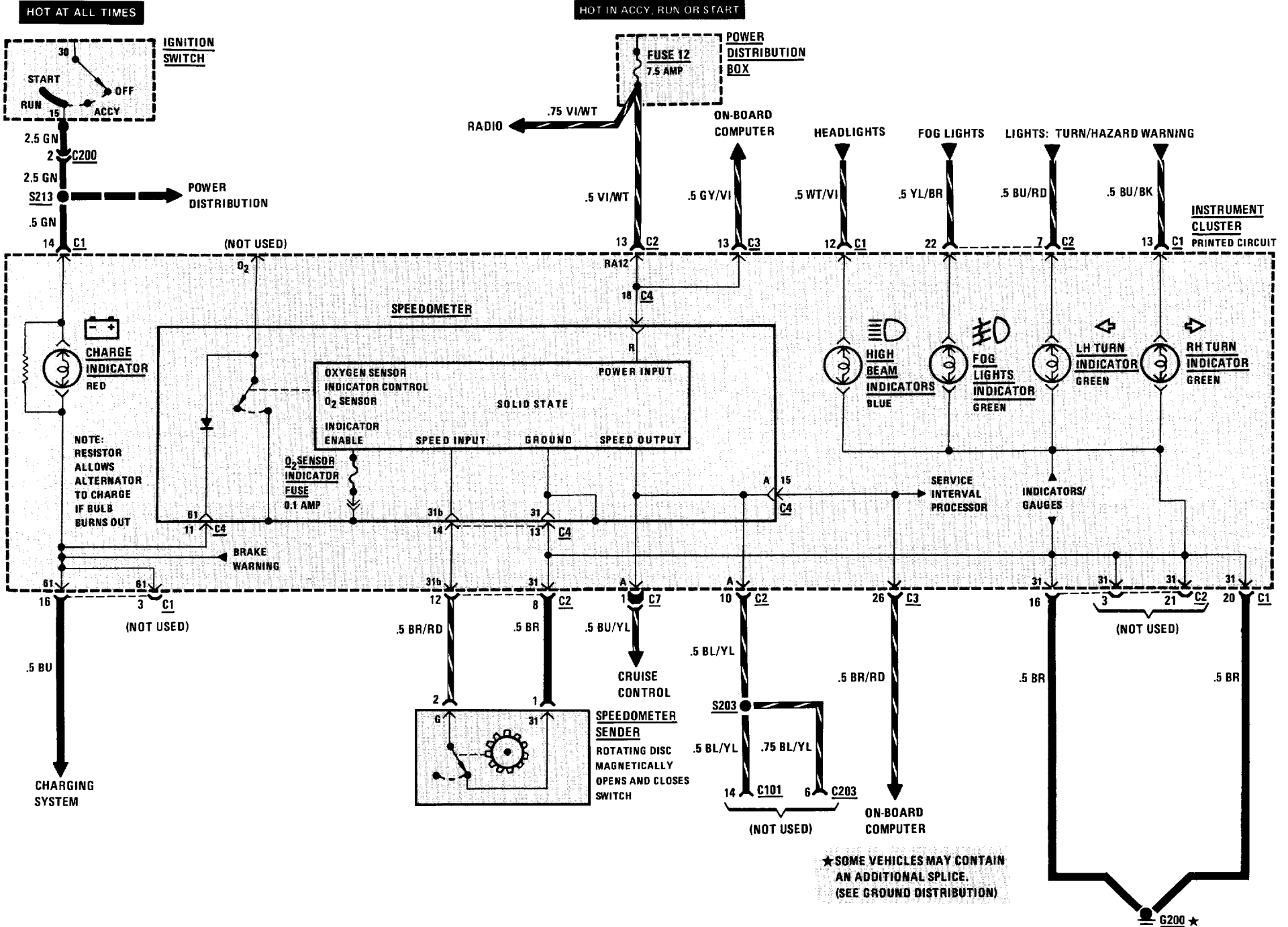



SERVICE INTERVAL INDICATOR

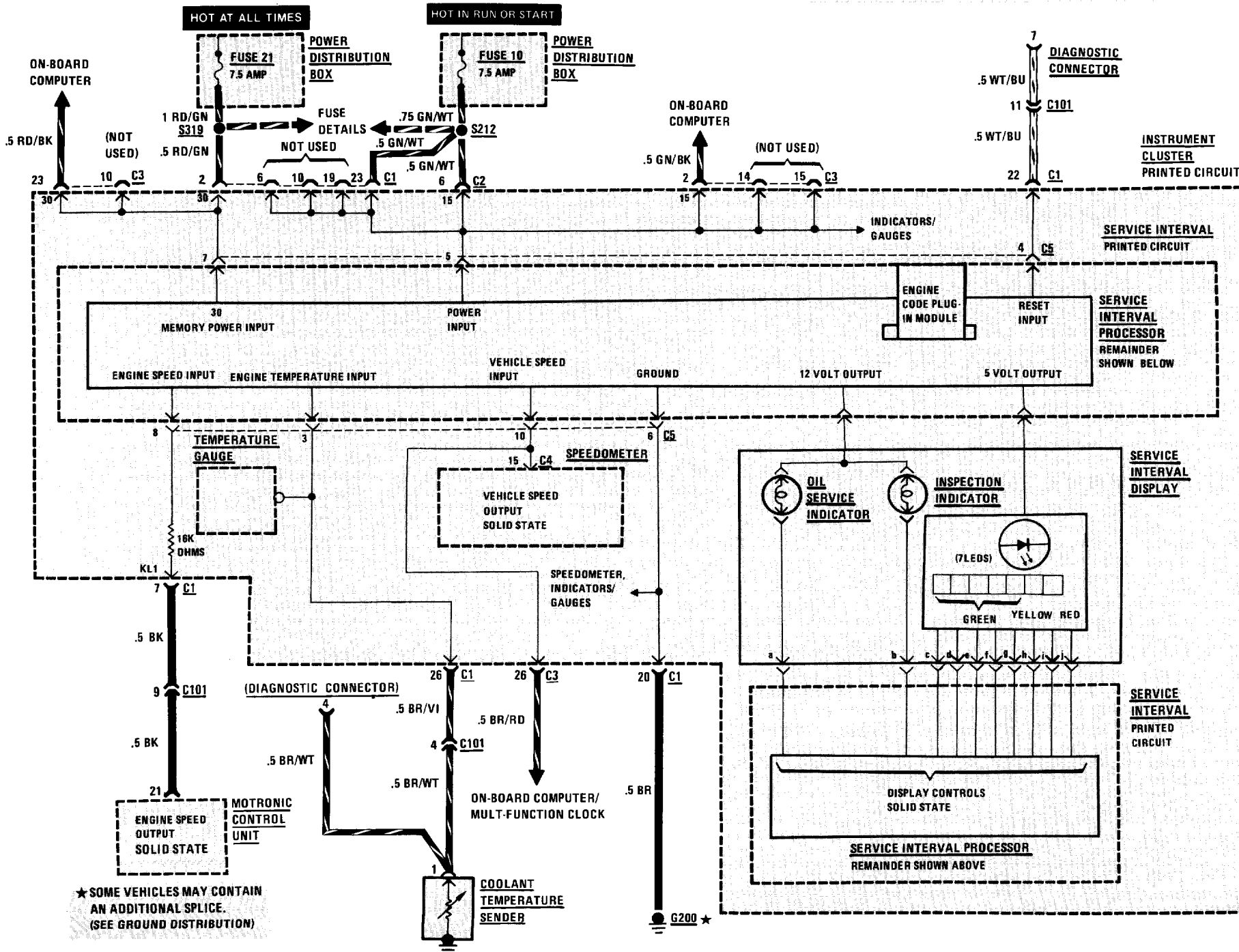

# 6210-2 INSTRUMENT CLUSTER

## GAUGES

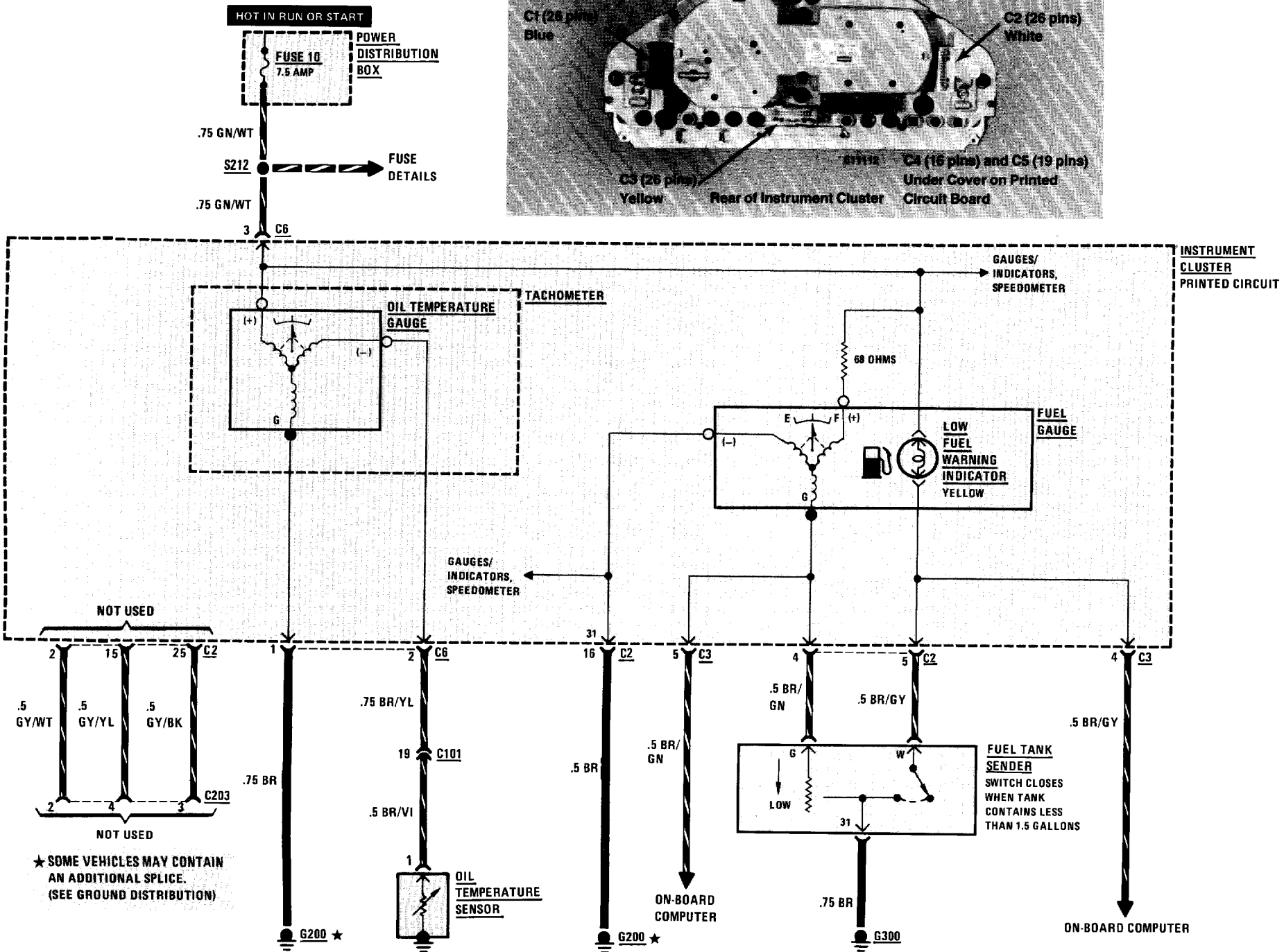
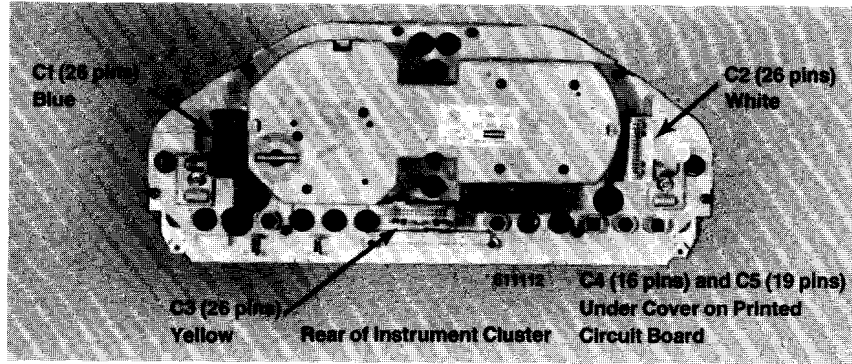



# 6210-4 INSTRUMENT CLUSTER

## GAUGES/INDICATORS

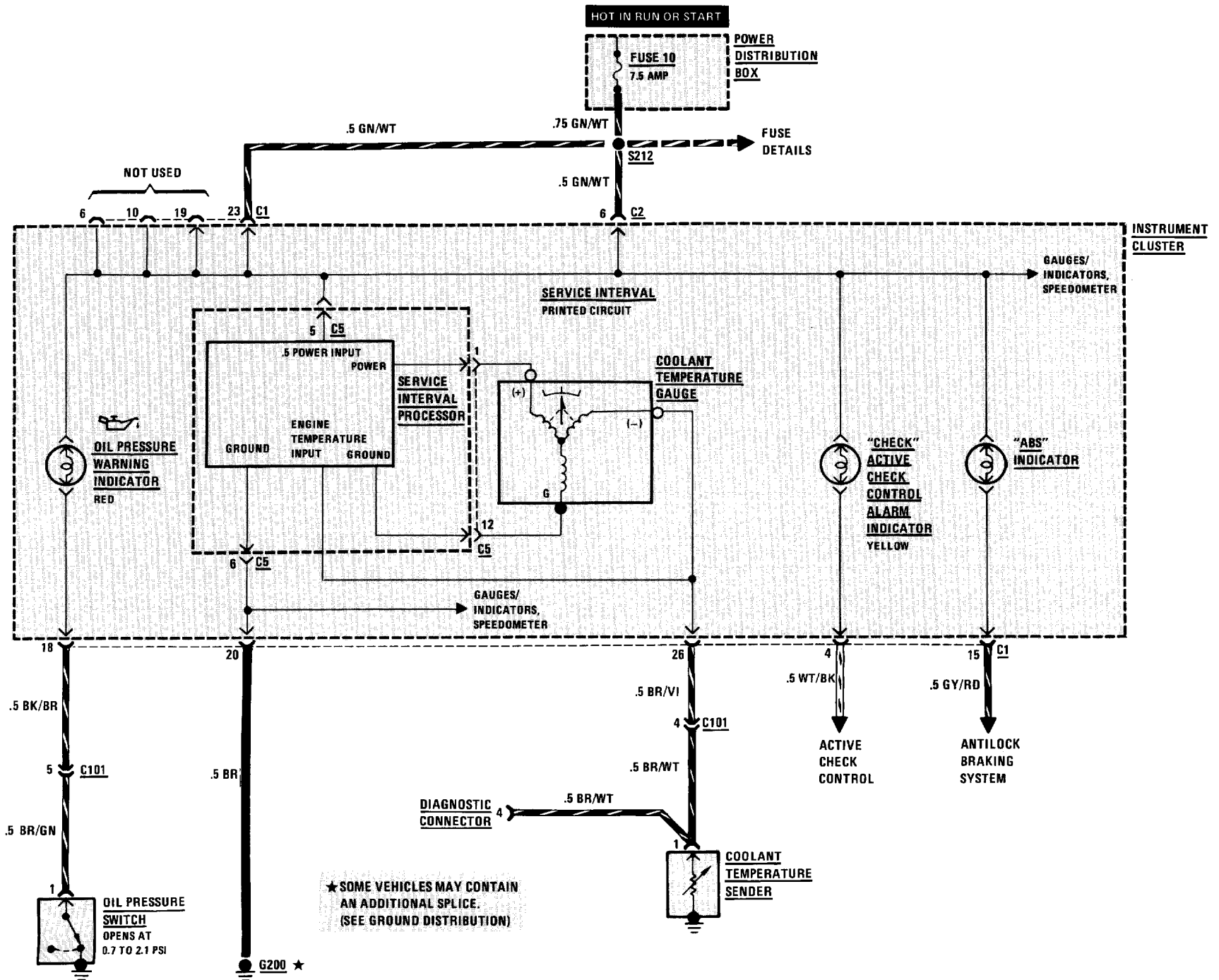

## ACTIVE CHECK CONTROL

1. When the Ignition Switch is initially placed in "Run," the Active Check Control Arm Indicator flashes, and the Active Check Control Unit Brake Light LED and panel light illuminate for test purposes. Depressing the brake pedal clears the display.
2. When the Ignition Switch is placed in "Run," fault monitoring begins. To monitor the low beams, rear lights, or license lights, those circuits must be on. The brake lights are monitored only while the brake pedal is depressed. An exception to this is when all brake light circuits are open. A fault will be indicated with the ignition switch in "RUN".
3. When a fault occurs, the alarm indicator flashes, the appropriate LED fault indicator lights, and the panel light goes on for five seconds. Depressing the test button will clear the alarm indicator, but the LED fault indicator remains on.
4. To test the unit, depress the test button. The LED fault indicators and the panel lights should go on.

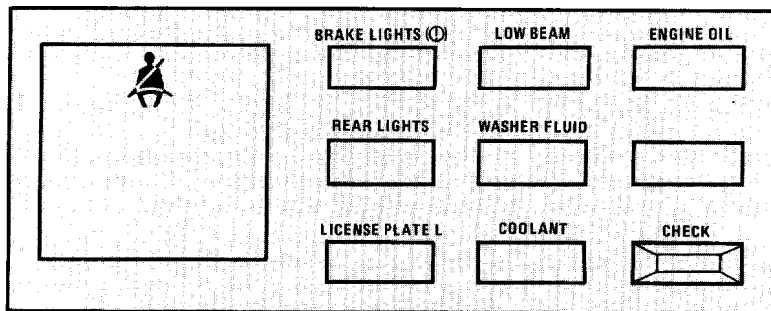
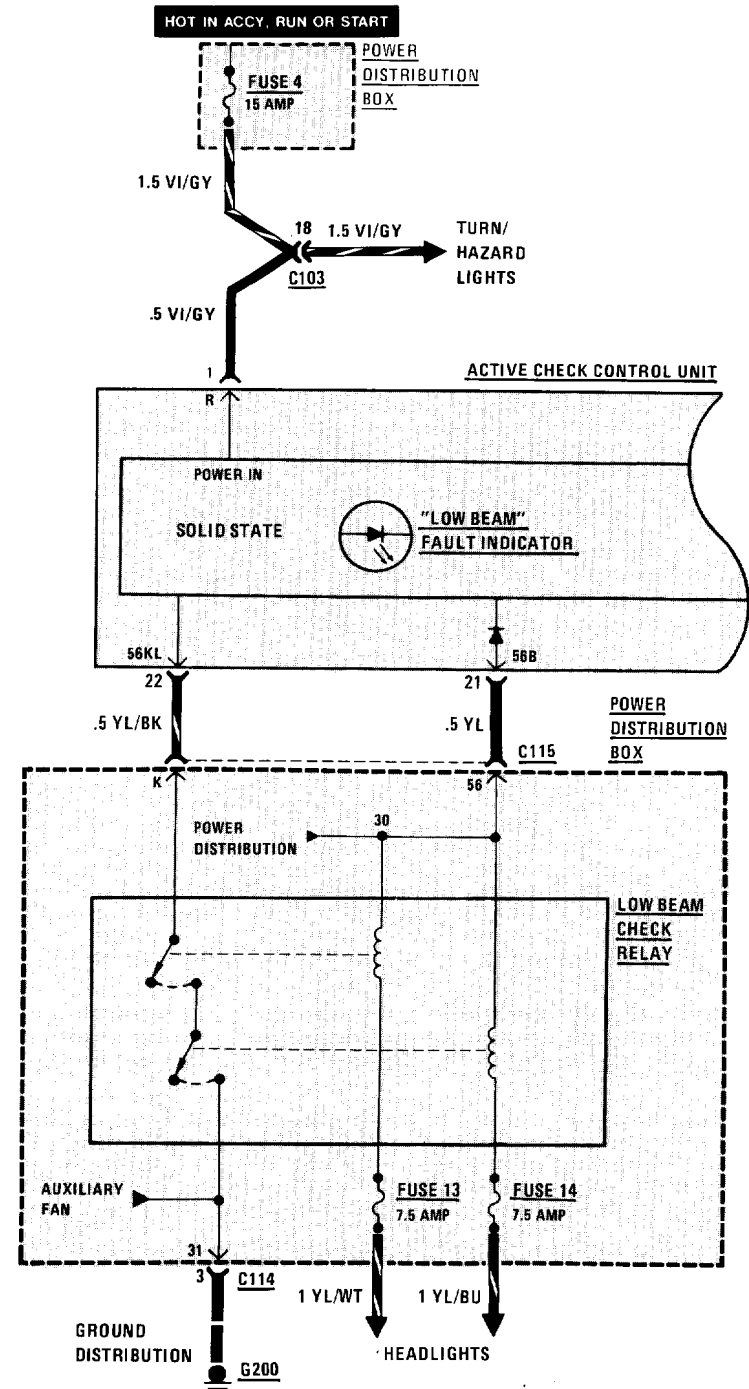
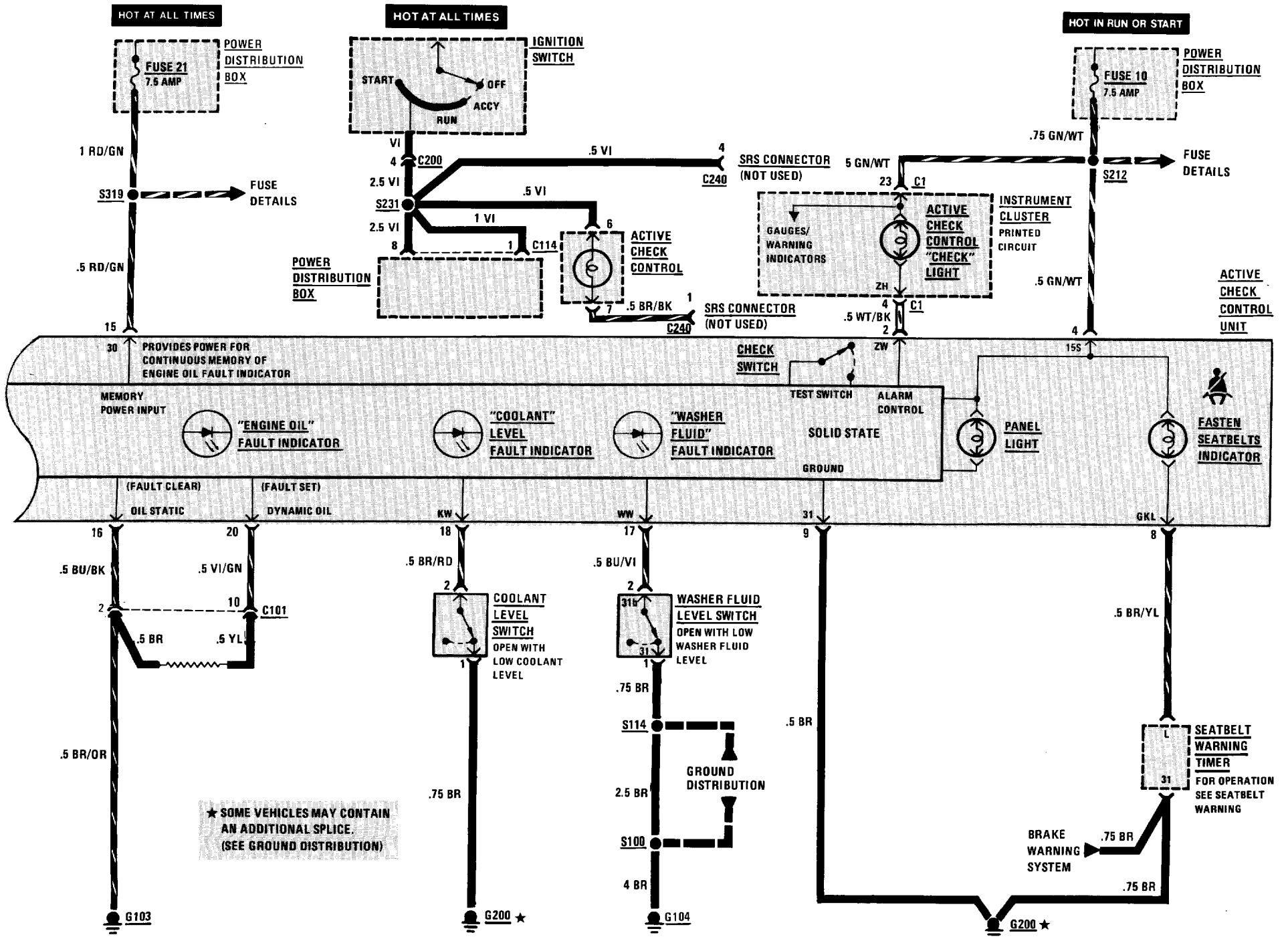

Figure 1 - Active Check Control Unit Above Rear View Mirror





# 6216-2 ACTIVE CHECK CONTROL



# 6300-0 LIGHT SWITCH DETAILS

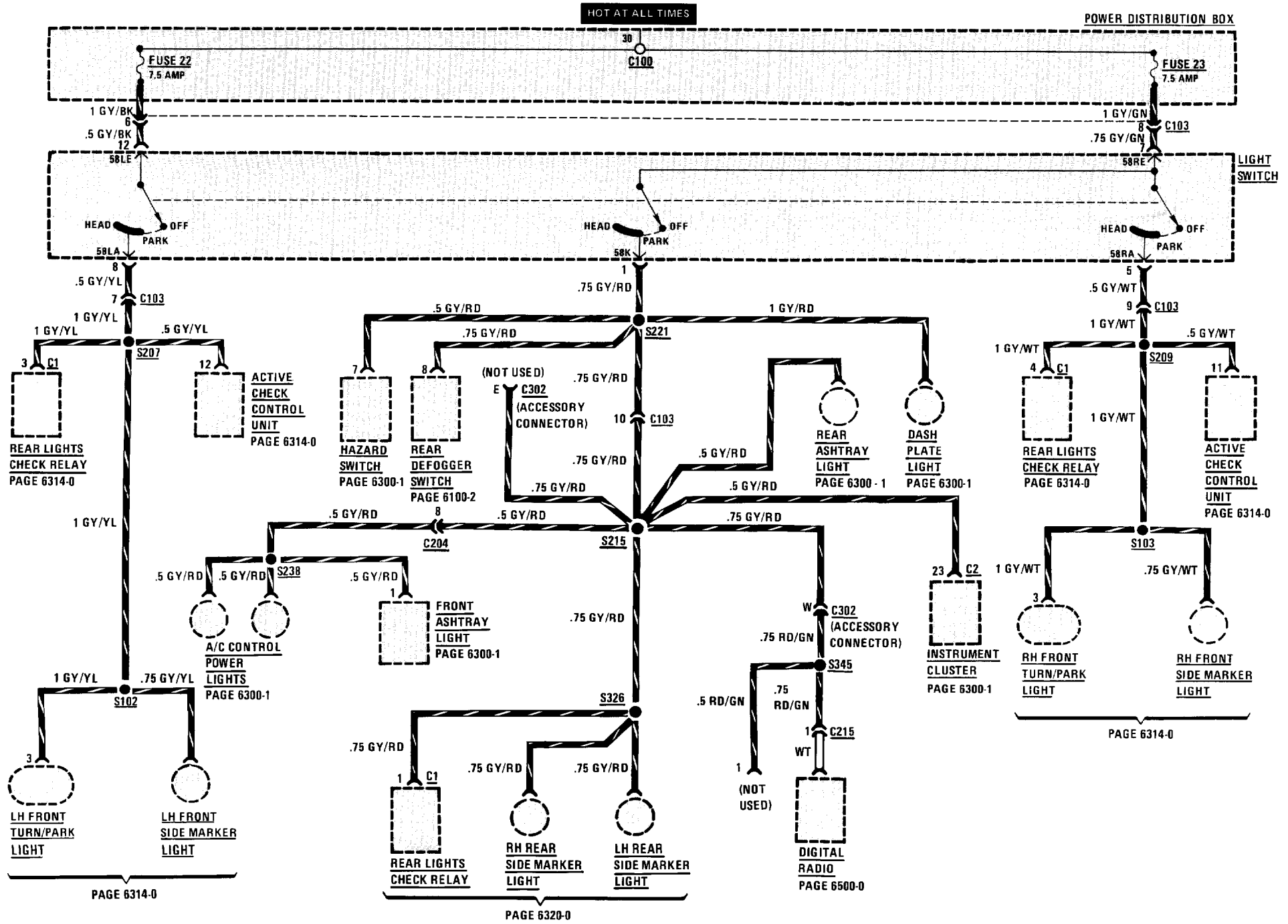



DASH LIGHTS

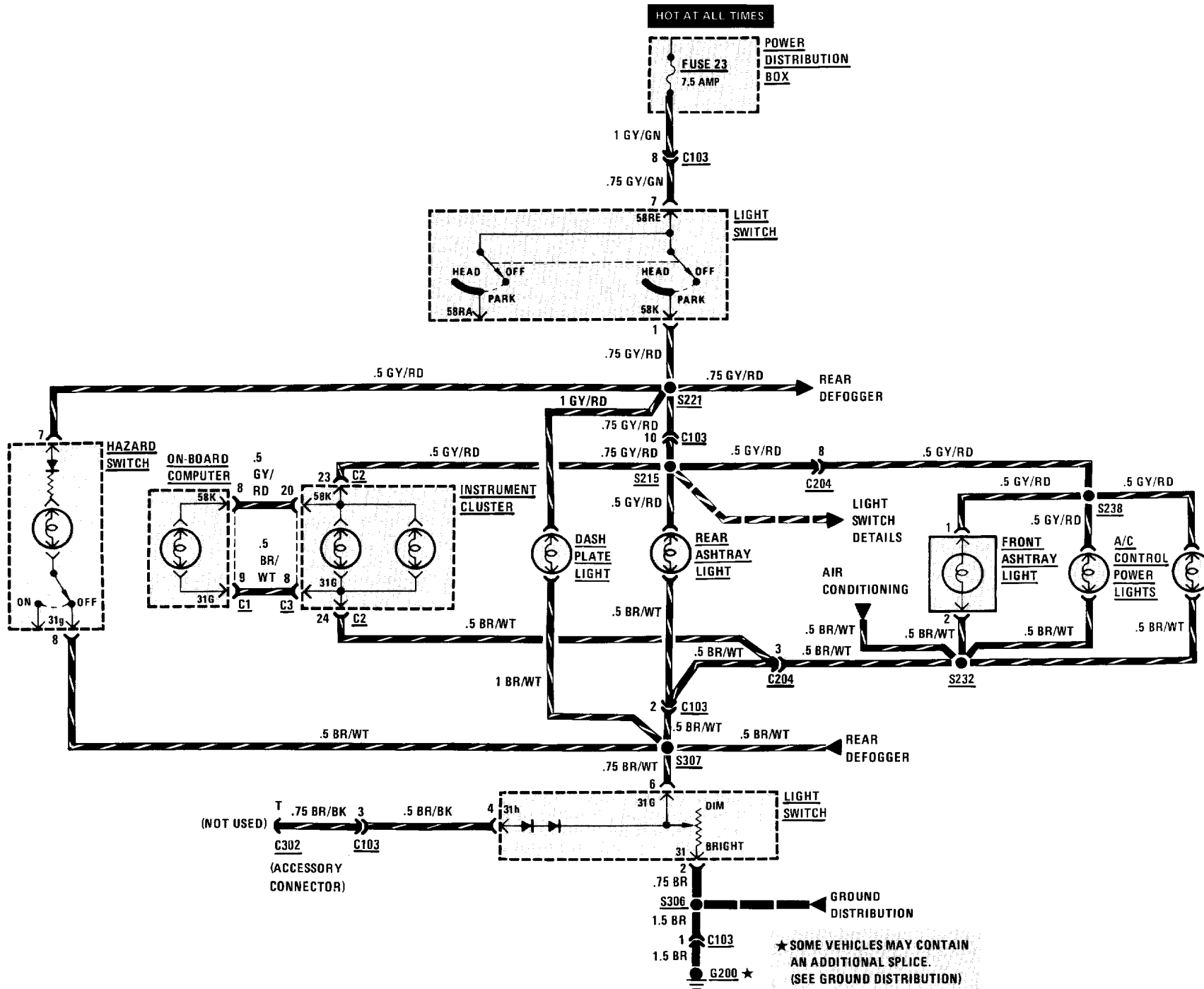



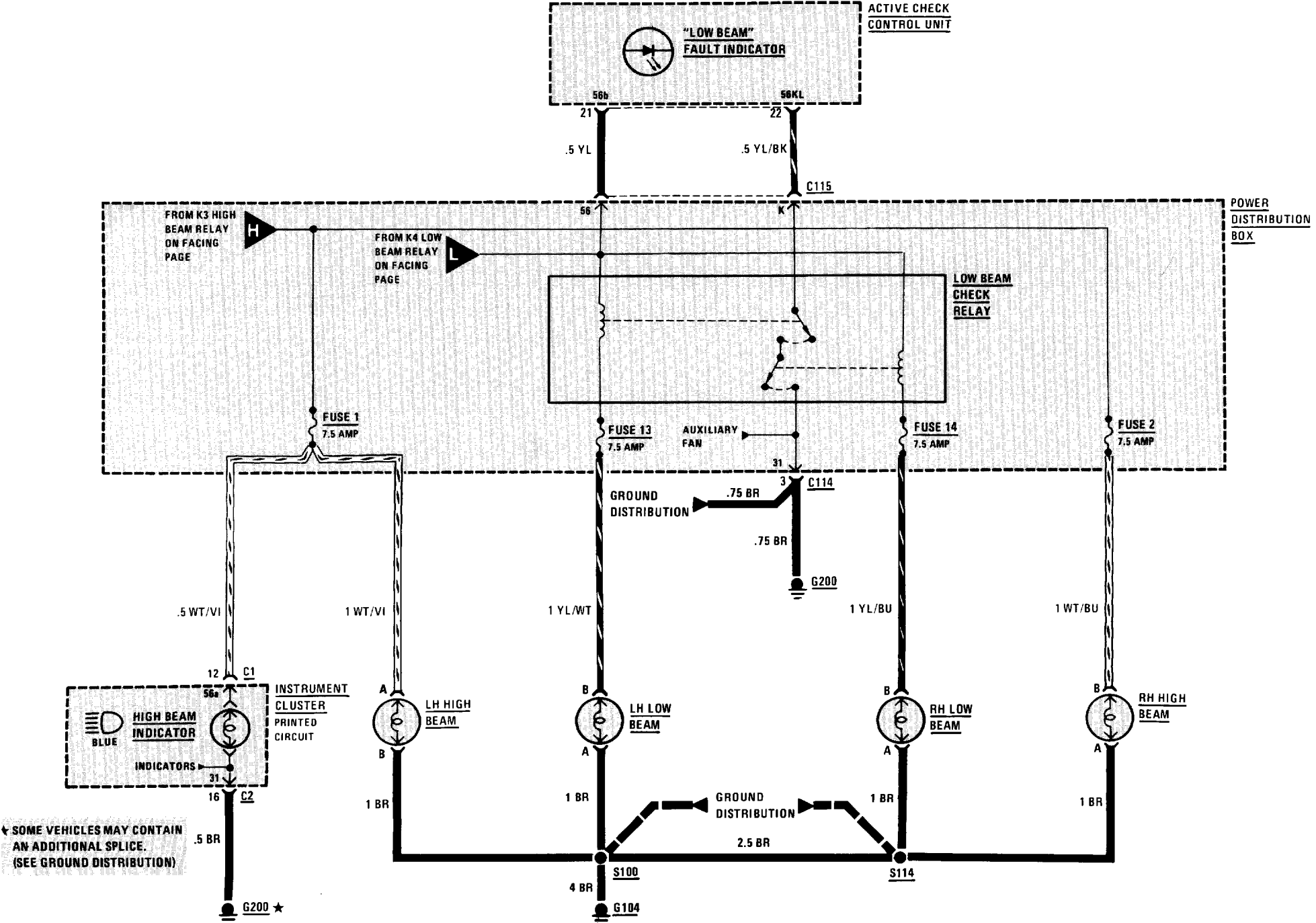

← SOME VEHICLES MAY CONTAIN AN ADDITIONAL SPLICE. (SEE GROUND DISTRIBUTION)



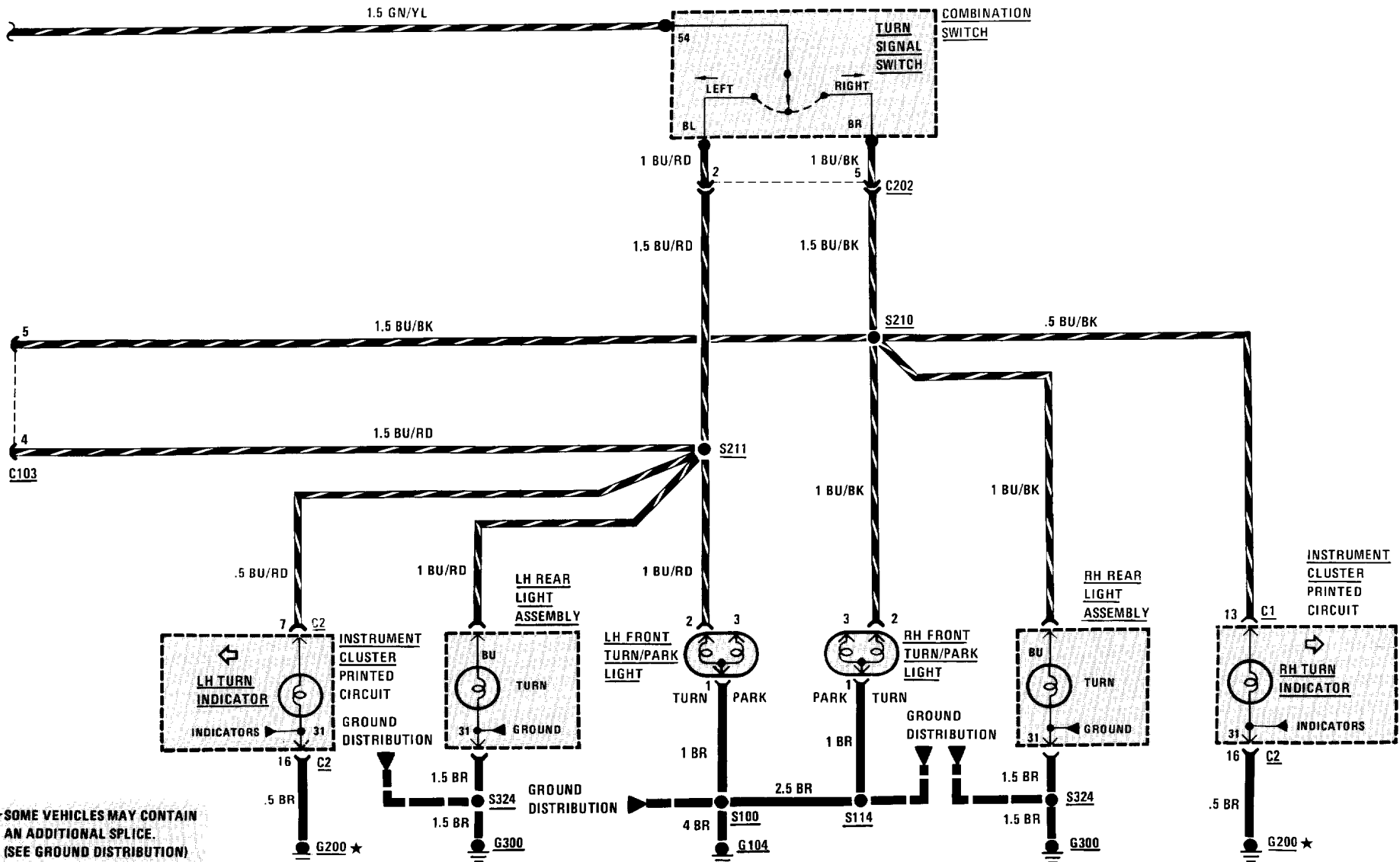

★ SOME VEHICLES MAY CONTAIN AN ADDITIONAL SPLICE. (SEE GROUND DISTRIBUTION)

# 6314-0 PARK/TAIL/FRONT MARKER LIGHTS

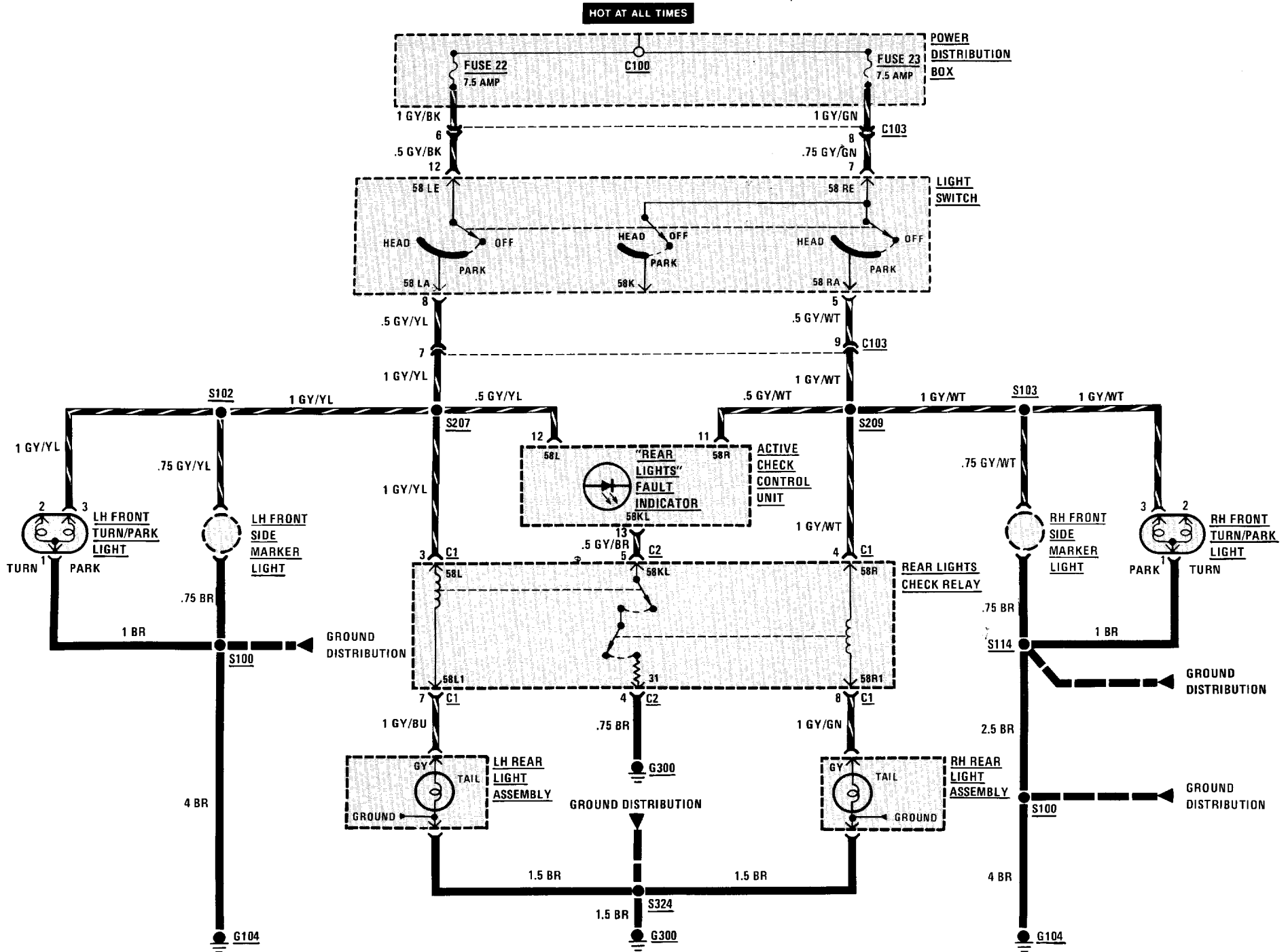

# 6320-0 REAR MARKER/LICENSE/TRUNK LIGHTS

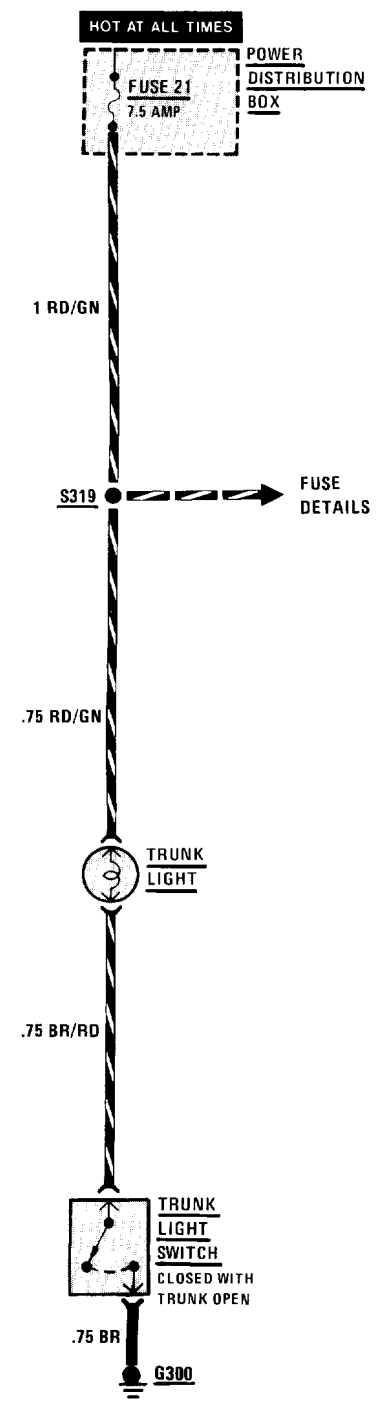
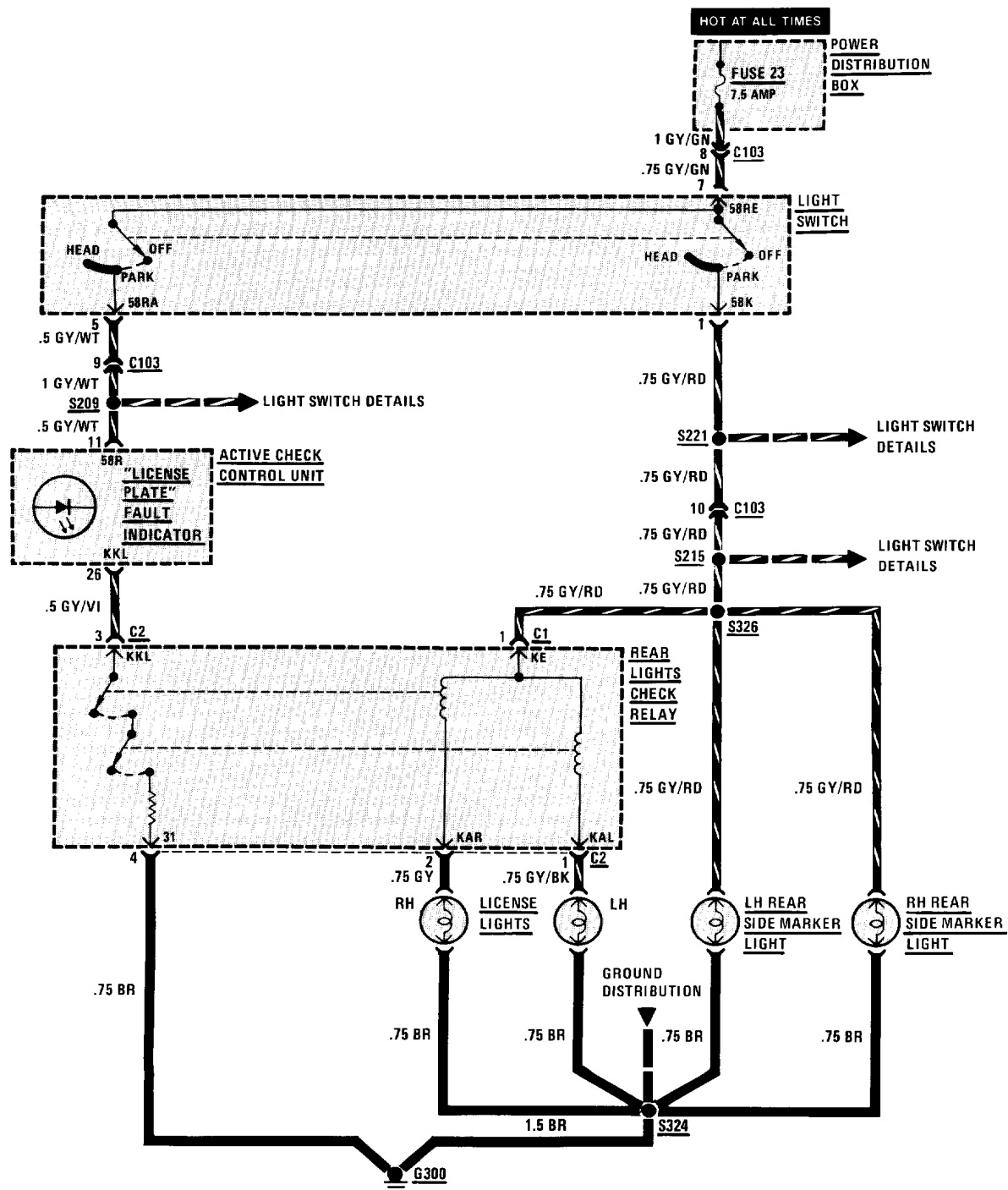

# 6322-0 BACKUP LIGHTS

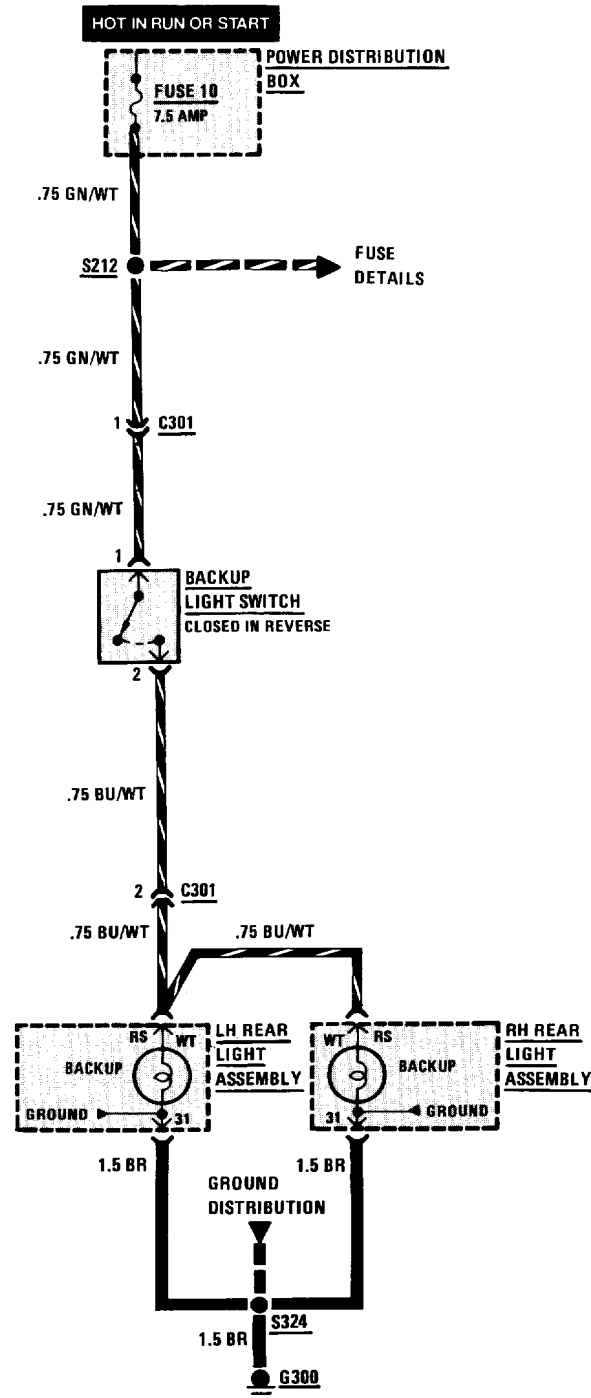



# 6325-0 STOP LIGHTS

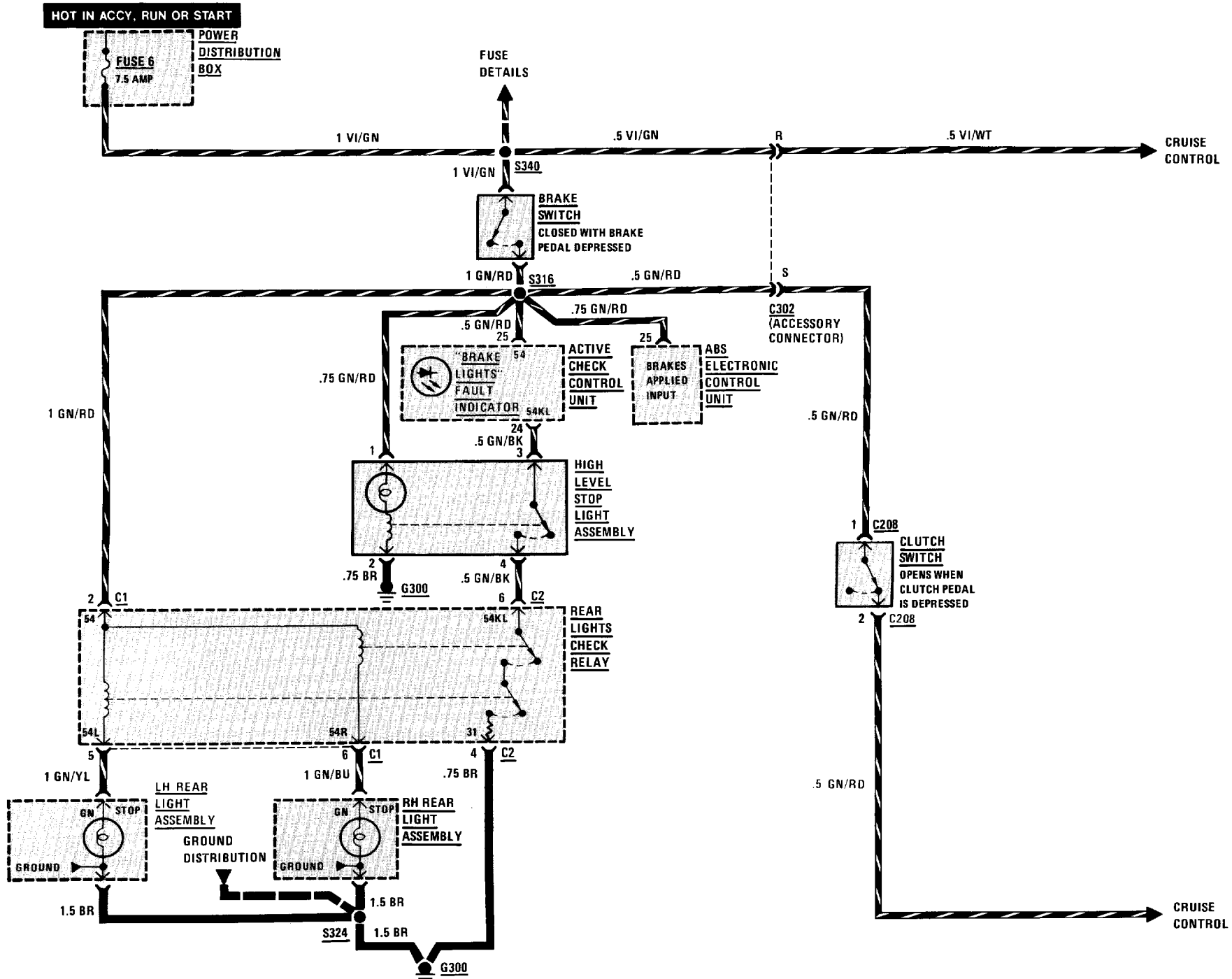

# 6330-0 INTERIOR LIGHTS

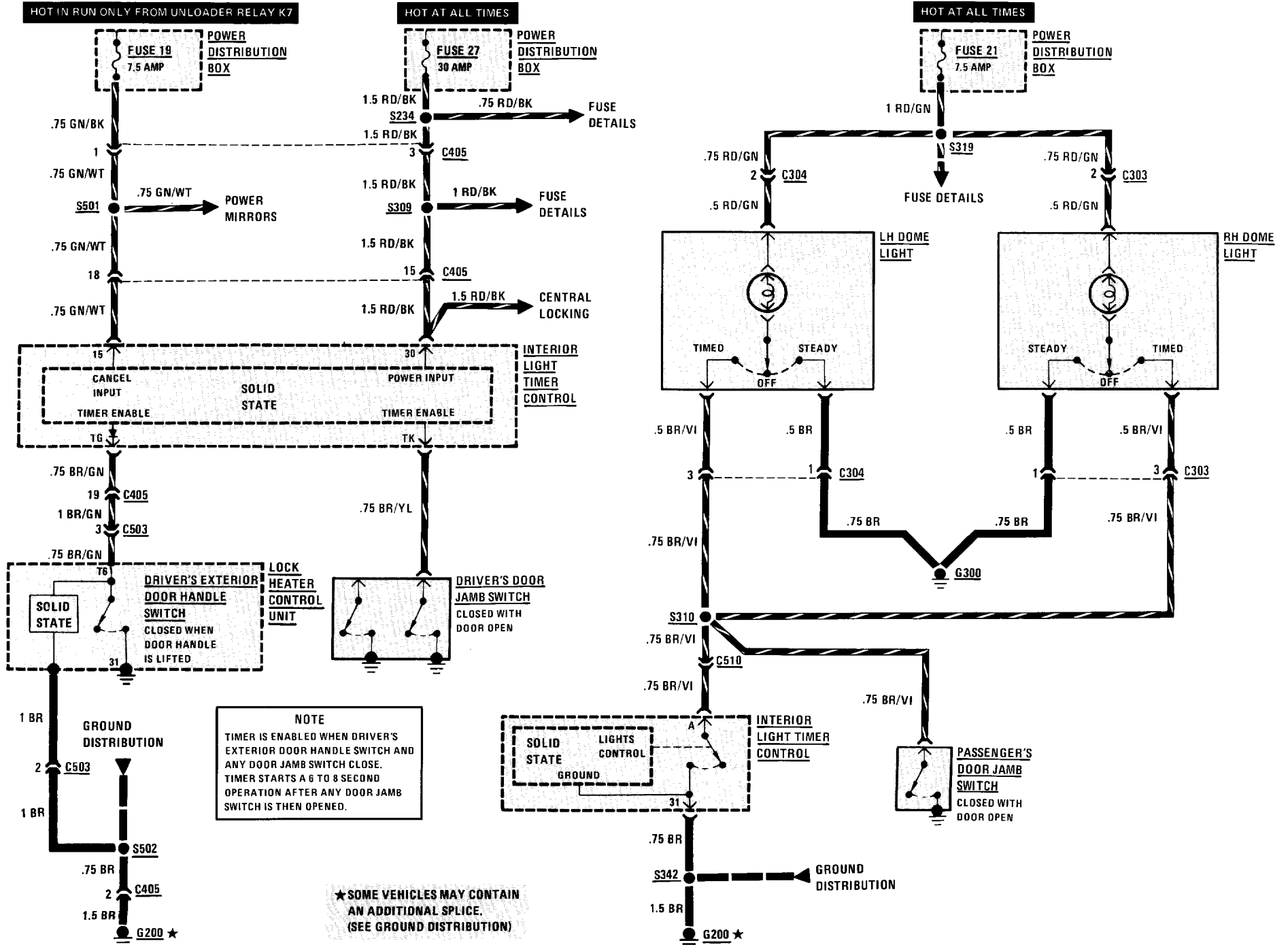

## 6410-0 HEATING AND AIR CONDITIONING

### SYSTEM CHECK

This procedure provides an overall check of the Heating and Air Conditioning System. Each of the steps can be performed without disassembly or the use of tools.

Complete this procedure with the temperature outside the car above 60 degrees F (16 degrees C) and the engine warm and running at idle.

### SYSTEM CHECK TABLE

<b>SET: Temperature Control fully counterclockwise Upper and Lower Slide Levers to extreme left Center Slide Lever to extreme right Blower Speed Control at 0 (OFF)</b>	
<b>ACTION</b>	<b>NORMAL RESULT</b>
Press Fresh/Recirculating Air Switch (ON). Release A/C button (OFF).	Fresh/Recirculating pushbutton lights. Blower runs slowly.
Rotate Blower Speed Control through steps 1 to 4	Blower speed increases at each step to maximum speed at Step 4
Press Fresh/Recirculating Air Switch to release it (OFF)	Fresh/Recirculating button is no longer lit. Outside air is drawn into car. (The sound of Flap Door Motors may be heard repositioning flaps.)
Rotate Temperature Control at least 1/4 turn clockwise	Air flow becomes warm
Depress A/C button (ON)	A/C button lights. A/C Compressor runs. Auxiliary Cooling Fan runs.
Press A/C button to release it (OFF)	A/C button is no longer lit. A/C Compressor turns off. Auxiliary Cooling Fan turns off.
Set Blower Speed Control to 0 (OFF)	Blower turns off

- If all of the steps can be completed as described, the Heating and Air Conditioning System is operating normally.

# 6411-0 A/C TEMPERATURE CONTROL

## HEATING AND AIR CONDITIONING (HOT WATER CONTROL)

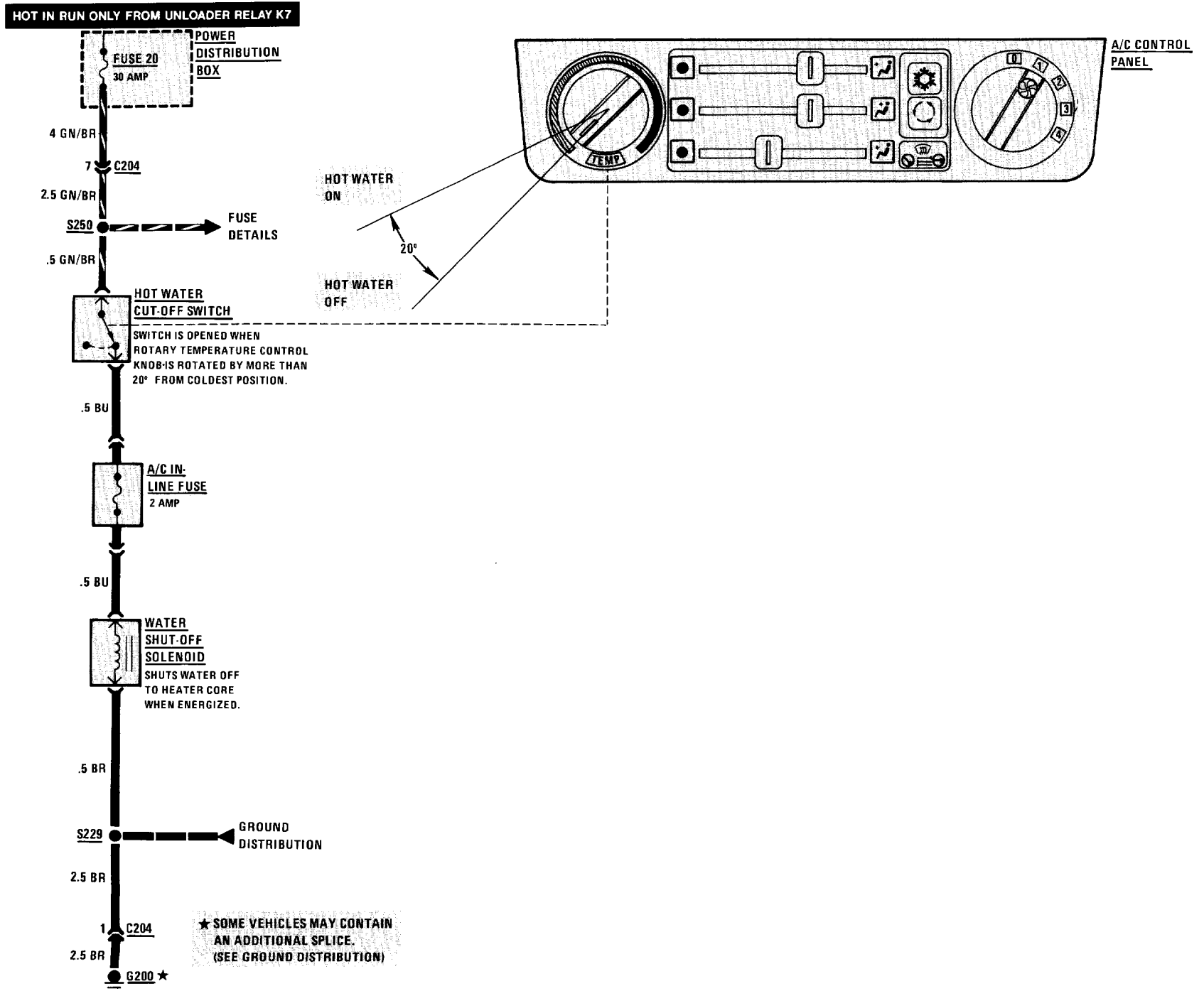

**CIRCUIT OPERATION**

The Water Shut-Off Solenoid controls the flow of engine coolant through the heater core. When the solenoid is energized, coolant flow is shut off to allow maximum cooling from the air conditioning system. The Water Shut-Off Solenoid is controlled by the Hot Water Cut-Off Switch, which is part of the A/C Control Panel TEMP Control.

Battery voltage is applied through Fuse 20 to the Hot Water Cut-Off Switch when the Ignition Switch is in RUN. The Hot Water Cut-Off Switch is closed when the TEMP Control is rotated fully counterclockwise (coldest position), and opens when the control is rotated more than 20 degrees in a clockwise direction. When the switch is closed, battery voltage is applied through the A/C In-Line Fuse to the Water Shut-Off Solenoid. The solenoid is energized and shuts off the coolant flow through the heater core.

The Water Shut-Off Solenoid and A/C In-Line Diode are protected by the A/C In-Line Fuse. If any failures occur in the solenoid, the fuse will isolate them to prevent the failures from affecting other parts of the heating and air conditioning circuits.

**TROUBLESHOOTING HINTS**

- Try the following checks before doing the System Diagnosis.
- 1. Check that Water Shut-Off Solenoid connector is firmly seated.
- 2. Check the A/C In-Line Fuse.
- Go to Heating and Air Conditioning (6410-0) System Check for a guide to normal operation.
- Go to System Diagnosis for diagnostic tests.

**SYSTEM DIAGNOSIS**

- Do the following test if the Water Shut-Off Solenoid does not operate normally.

**WATER SHUT-OFF SOLENOID TEST (TABLE 1)**

Measure: VOLTAGE At: WATER SHUT-OFF SOLENOID CONNECTOR (Disconnected) Conditions: • Ignition Switch: RUN • A/C Control Panel TEMP Control: FULLY COUNTERCLOCKWISE		
Measure Between	Correct Voltage	For Diagnosis
BU & Ground	Battery	See 1
BU & or BR	Battery	See 2
• Rotate A/C Control Panel TEMP Control to Mid-Position		
BU & Ground	0 Volts	See 3

(Continued in next column)

(Continued from previous column)

- If all voltages are correct, replace the Water Shut-Off Solenoid.
- 1. Check the BU wire and A/C In-Line Fuse for an open. If wire and fuse are good, go to Table 2.
- 2. Check the BR wire for an open to ground. Check that connector C204 is properly mated.
- 3. Check BU wire for a wire-to-wire short to voltage. If wire is good, replace the A/C Control Panel TEMP Control.

**WATER SHUT-OFF SOLENOID TEST (TABLE 2)**

Measure: VOLTAGE At: HOT WATER CUT-OFF SWITCH CONNECTOR (Disconnected) Conditions: • Ignition Switch: RUN • Water Shut-Off Solenoid: CONNECTED		
Measure Between	Correct Voltage	For Diagnosis
GN/BR & Ground	Battery	See 1
GN/BR & BU	Battery	See 2
• If both voltages are correct, replace the A/C Control Panel TEMP Control.		
1. Check the GN/BR wire for an open back to Fuse 20.		
2. Check the BU wire for an open.		



**CIRCUIT OPERATION**

With the Ignition Switch in RUN, battery voltage is applied to the Control Switches and the Blower Speed Control through the GN/BR wires. If either the A/C Select Switch or the Fresh/Recirculating Air Switch are ON or the Blower Speed Control is in position 1, battery voltage is applied through the YL wire to the Blower Resistors and the Blower Motor.

The Blower Motor is a variable speed motor which runs at a speed proportional to the voltage applied to it. With all of the Blower Resistors in the circuit, the voltage applied to the Motor is reduced so the Motor runs at a low speed.

As the Blower Speed Control is moved through positions 2 and 3, some of the Resistors are bypassed, allowing more voltage to be applied to the Blower Motor, which then runs at a higher speed. When the Blower Speed Control is moved to position 4, battery voltage is applied directly to the Blower Motor, which then runs at maximum speed.

The Blower Resistors dissipate heat because of the current flowing through them. They are cooled by the air flow from the Blower. If there is insufficient air flow to cool the Resistors, the Safety Switch will open, shutting the Blower Motor off until the Resistors have cooled.

**TROUBLESHOOTING HINTS**

- Try the following checks before doing the System Diagnosis.
- 1. Check Fuse 20 by visual inspection.
- 2. If Blower will run in high only, check the Blower Resistors' Safety Switch for an open.
- Go to Heating and Air Conditioning (6410-0) System Check for a guide to normal operation.
- Go to System Diagnosis for diagnostic tests.

**SYSTEM DIAGNOSIS**

- Do the tests listed for your symptom in the Symptom Table below.
- Tests follow the Symptom Table.

**SYMPTOM TABLE**

SYMPTOM	DO TEST
Blower Motor does not run in any speed setting.	B
Blower runs only in HIGH (does not run in any other-speed setting).	B
Blower does not run in some modes.	A
Blower does not run with A/C ON or in Recirculating mode.	A
A/C Select Switch or Fresh/Recirculating Air Switch does not light.	A

**A: CONTROL SWITCH VOLTAGE TEST**

<b>Measure: VOLTAGE</b>		
<b>At: CONTROL SWITCHES CONNECTOR (Disconnected)</b>		
<b>Conditions:</b>		
<ul style="list-style-type: none"> <li>• Ignition Switch: RUN</li> <li>• Blower Speed Control: OFF</li> </ul>		
Measure Between	Correct Voltage	For Diagnosis
1 (GN/BR) & Ground	Battery	See 1

(Continued in next column)

(Continued from previous column)

1 (GN/BR) & 3 (YL)	Battery	See 2 & 4
7 (GN/BR) & Ground	Battery	See 1
7 (GN/BR) & 5 (YL)	Battery	See 2 & 4
7 (GN/BR) & 6 (BR/WT)	Battery	See 3
<ul style="list-style-type: none"> <li>• If all voltages are correct, do Test B.</li> <li>1. Check the GN/BR wire for an open.</li> <li>2. Check the YL wire for an open.</li> <li>3. Check the BR/WT wire for an open.</li> <li>4. If voltage is not present between the GN/BR wire and both the YL wires (terminals 3 and 5), do Test B.</li> </ul>		

**B: BLOWER SPEED CONTROL TEST**

<b>Measure: VOLTAGE</b>		
<b>At: BLOWER SPEED CONTROL CONNECTOR (Disconnected)</b>		
<b>Conditions:</b>		
<ul style="list-style-type: none"> <li>• Ignition Switch: RUN</li> <li>• A/C Select Switch: ON (Depressed)</li> <li>• Fresh/Recirculating Air Switch: FRESH (Not Depressed)</li> </ul>		
Measure Between	Correct Voltage	For Diagnosis
4 (GN/BR) & Ground	Battery	See 1
7 (YL) & Ground	Battery	See 2
• A/C Select Switch: OFF (Not Depressed)		
7 (YL) & Ground	0 Volts	See 3

(Continued on next page)

## 6413-2 A/C BLOWER CONTROLS

(Continued from previous page)

4 (GN/BR) & 7 (YL)	Battery	See 4, 8, 9, & 10
4 (GN/BR) & 1 (BK)	Battery	See 5, 8, 9, & 10
4 (GN/BR) & 2 (GN)	Battery	See 6, 8, 9, & 10
4 (GN/BR) & 3 (BU)	Battery	See 7 & 10

- If all voltages are correct, replace the Blower Motor.
1. Check the GN/BR wire for an open.
  2. Check the YL wire for an open between Blower Speed Control and splice S231.
  3. Check the YL wire for a wire to wire short to voltage.
  4. Check the YL wire for an open between splice S231 and the Blower Resistors.
  5. Check the BK wire for an open.
  6. Check the GN wire for an open.
  7. Check the BU wire for an open.
  8. If voltage is not present at the YL wire, but is present at the GN wire or BK wire, replace the Blower Resistors.
  9. If voltage is not present at the YL, BK or GN wires, check for an open Blower Resistors' Safety Switch.
  10. If voltage is not present at the YL, BK, GN and BU wires, do Test C.

### C: BLOWER MOTOR TEST

<b>Measure: VOLTAGE</b>		
<b>At: BLOWER MOTOR CONNECTOR (Disconnected)</b>		
<b>Conditions:</b>		
<ul style="list-style-type: none"> <li>• Ignition Switch: RUN</li> <li>• A/C Select Switch: ON</li> <li>• Blower Speed Control: HIGH</li> </ul>		
<b>Measure Between</b>	<b>Correct Voltage</b>	<b>For Diagnosis</b>
BU & Ground	Battery	See 1
BU & BR	Battery	See 2
<ul style="list-style-type: none"> <li>• If both voltages are correct, replace the Blower Motor.</li> </ul> <ol style="list-style-type: none"> <li>1. Check the BU wire for an open. If wire is good, recheck Test B.</li> <li>2. Check the BR wire to ground G200 for an open.</li> </ol>		



# 6421-0 A/C AIR DELIVERY CONTROL

## HEATING AND AIR CONDITIONING (FRESH/RECIRCULATING AIR CONTROLS)

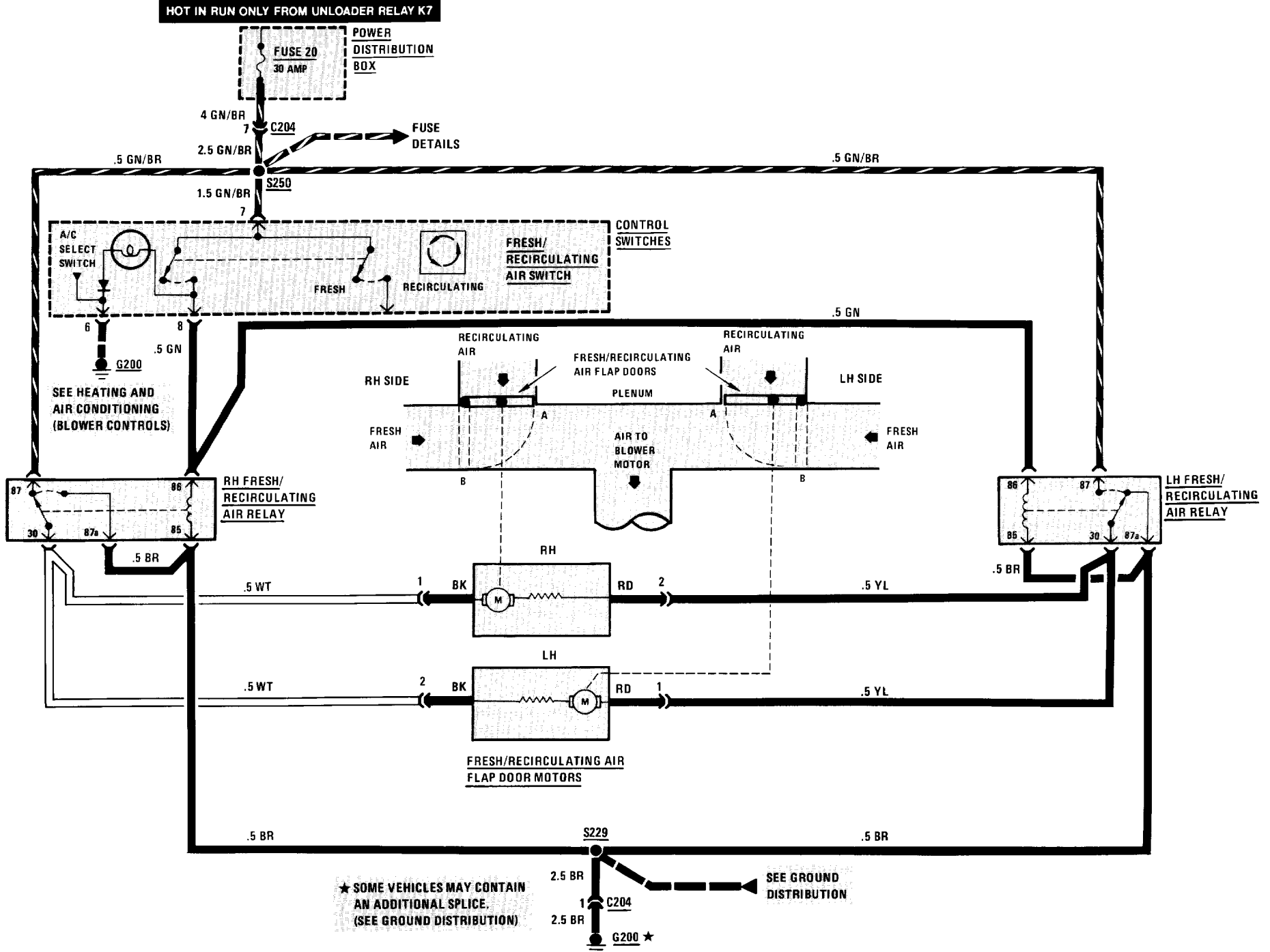

**CIRCUIT OPERATION**

When the Ignition Switch is in RUN, battery voltage is applied to terminal 7 of the Control Switches, the normally open contacts of the LH Fresh/Recirculating Air Relay, and the normally closed contacts of the RH Fresh/Recirculating Air Relay. If the Fresh/Recirculating Air Switch is not depressed (open), battery voltage is applied through the normally closed contacts of the RH Fresh/Recirculating Air Relay to both Fresh/Recirculating Air Flap Door Motors and then to ground through the normally closed contacts of the LH Fresh/Recirculating Air Relay. Both motors operate and move the Fresh/Recirculating Air Flap Doors to position A, allowing fresh air to enter the blower.

When the Fresh/Recirculating Air Switch is depressed (closed), battery voltage is applied through the switch to both the LH and RH Fresh/Recirculating Air Relay coils. Both relays are energized. Battery voltage is then applied through the closed contacts of the LH Fresh/Recirculating Air Relay to the Flap Door Motors, and to ground through the closed contacts of the RH Fresh/Recirculating Air Relay. Since the voltage is now applied to the Flap Door Motors in the opposite direction, the motors reverse direction and move the Fresh/Recirculating Air Flap Doors to position B, allowing only recirculating air to enter the blower. Both of the Air Flap Door Motors remain energized continuously. When the doors reach the end of their travel, the motors stall and hold the doors in position.

**TROUBLESHOOTING HINTS**

- Try the following checks before doing the System Diagnosis.
- 1. Check that LH and RH Fresh/Recirculating Air Relays are firmly seated.
- 2. Check that LH and RH Fresh/Recirculating Air Relay pigtail connectors are properly mated.
- Go to Heating and Air Conditioning (6410-0) System Check for a guide to normal operation.
- Go to System Diagnosis for diagnostic tests.

**SYSTEM DIAGNOSIS**

- Do the tests below if the Fresh/Recirculating Air Flap Doors do not operate.

**A: FRESH/RECIRCULATING AIR FLAP DOOR MOTOR VOLTAGE TEST**

Measure: VOLTAGE At: FRESH/RECIRCULATING AIR FLAP DOOR MOTOR PIGTAIL CONNECTORS (Disconnected) Conditions: • Ignition Switch: RUN • Fresh/Recirculating Air Switch: RELEASED (FRESH)		
Measure Between	Correct Voltage	For Diagnosis
WT and Ground	Battery	See 1
WT and YL	Battery	See 2
• Fresh/Recirculating Air Switch: DEPRESSED (RECIRCULATING)		
YL and Ground	Battery	See 3

(Continued in next column)

(Continued from previous column)

YL and WT	Battery	See 3
• If all voltages are correct, replace the inoperative motor. 1. Check the WT wire for an open. If wire is good, do Test B for RH Air Relay. 2. Check the YL wire for an open. If wire is good, do Test B for LH Air Relay. 3. Do Test B for both Air Relays.		

**B: FRESH/RECIRCULATING AIR RELAY VOLTAGE TEST**

Measure: VOLTAGE At: FRESH/RECIRCULATING AIR RELAY CONNECTOR (Disconnected) Conditions: • Ignition Switch: RUN • Fresh/Recirculating Air Switch: DEPRESSED (RECIRCULATING) • Fresh/Recirculating Air Flap Door Motor Connectors: CONNECTED		
Measure Between	Correct Voltage	For Diagnosis
87 (GN/BR) and Ground	Battery	See 1
86 (GN) and Ground	Battery	See 2
86 (GN) and 85 (BR)	Battery	See 3
86 (GN) and 87a (BR)	Battery	See 3

(Continued on next page)

## 6421-2 A/C AIR DELIVERY CONTROL

---

(Continued from previous page)

- If all voltages are correct, replace the suspect Fresh/Recirculating Air Relay.
1. Check the GN/BR wire for an open.
  2. Check the GN wire back to the Control Switches for an open. If wire is good, do Test C.
  3. Check the BR wire for an open.

### C: CONTROL SWITCHES VOLTAGE TEST

Measure: VOLTAGE

At: CONTROL SWITCHES CONNECTOR  
(Disconnected)

Condition:

- Ignition Switch: RUN

Measure Between	Correct Voltage	For Diagnosis
7 (GN/BR) & Ground	Battery	See 1
7 (GN/BR) & 8 (GN)	Battery	See 2

- If both voltages are correct, replace the Control Switches.
1. Check the GN/BR wire for an open. If wire is good, check that connector C204 is properly mated.
  2. Check the GN wire for an open between the Control Switches and the LH and RH Fresh/Recirculating Air Relays.





**CIRCUIT OPERATION**

When the Ignition Switch is in RUN, battery voltage is applied through Fuse 20 to the A/C Select Switch. When the A/C Select Switch is pressed, voltage is applied to terminal 3 of the Evaporator Temperature Regulator. The Evaporator Temperature Regulator applies voltage from terminal 2 to the Compressor Clutch through the High Pressure Cut-Out Switch, the Low Pressure Cut-Out Switch, and the Temperature Switch.

The High Pressure Cut-Out Switch will disengage the Compressor Clutch when refrigerant pressure rises above 385 PSI (26.6 Bar). The Evaporator Temperature Regulator will detect the High Pressure Cut-Out Switch opening at terminal 5 and will turn off the output voltage at the Compressor Control terminal. The Evaporator Temperature Regulator will not allow the Compressor Clutch to be turned on again until circuit continuity has been restored between terminals 5 and 2. The regulator tests for continuity by momentarily applying voltage at the Compressor Control every 8 to 10 seconds. Voltage at the A/C Clutch Monitor Input indicates continuity. The Evaporator Temperature Regulator will continue to apply voltage at the Compressor Control output, which will energize the Compressor.

The Temperature Switch opens to remove the compressor load from the engine if the engine coolant temperature rises above 226 °F (108 °C). The Evaporator Temperature Sensor signals the Evaporator Temperature Regulator to de-energize the Compressor Clutch when evaporator temperature is low enough for freezing to result.

**Clutch Diode**

Whenever the Compressor Clutch is de-energized, the collapsing magnetic field induces a voltage in the winding. The Clutch Diode provides a path for the resulting current.

**A/C On Input**

When the Compressor Clutch is turned on, voltage is applied to terminal 29 of the Motronic Control Unit. The Motronic Control Unit uses this signal to increase idle speed to compensate for the increased engine load from the Compressor Clutch engaging.

**TROUBLESHOOTING HINTS**

- **Try the following checks before doing the System Diagnosis.**
  1. Check Fuse 20 by visual inspection.
  2. Check that Compressor Clutch connector is firmly seated.
- **Go to Heating and Air Conditioning (6410-0) System Check for a guide to normal operation.**
- **Go to System Diagnosis for diagnostic tests.**

**SYSTEM DIAGNOSIS**

- **Do the tests listed for your symptom in the Symptom Table below.**
- **Tests follow the Symptom Table.**

**SYMPTOM TABLE**

Compressor Clutch does not engage	A
Engine idle speed is not high enough when Compressor Clutch engages	D

**A: A/C ISOLATION TEST (TABLE 1)**

<b>Measure: VOLTAGE</b> <b>At: EVAPORATOR TEMPERATURE REGULATOR (Disconnected)</b> <b>Conditions:</b> <ul style="list-style-type: none"> <li>• <b>Ignition Switch: RUN (Engine need not be running)</b></li> <li>• <b>A/C Selector Switch: Depressed (ON)</b></li> </ul>		
<b>Measure Between</b>	<b>Correct Voltage</b>	<b>For Diagnosis</b>
3 & Ground	Battery	See 1
<ul style="list-style-type: none"> <li>• If voltage is correct, go to Table 2.</li> <li>1. Go to Test E.</li> </ul>		

**A: A/C ISOLATION TEST (TABLE 2)**

Connect: FUSED JUMPER At: EVAPORATOR TEMPERATURE REGULATOR (Disconnected) Conditions: <ul style="list-style-type: none"> <li>• Ignition Switch: RUN</li> <li>• A/C Selector Switch: Depressed (ON)</li> </ul>		
Connect Across	Correct Result	For Diagnosis
2 & 3	Compressor Clutch Engages	See 1
<ul style="list-style-type: none"> <li>• If result is correct go to Test C.</li> </ul> 1. Go to Test B.		

**B: PRESSURE SWITCH TEST**

Measure: RESISTANCE At: EVAPORATOR TEMPERATURE REGULATOR CONNECTOR (Disconnected) Conditions: <ul style="list-style-type: none"> <li>• Ignition Switch: OFF</li> <li>• Negative Battery Terminal: DISCONNECTED</li> </ul>		
Measure Between	Correct Resistance	For Diagnosis
2 & Ground	Approximately 3 to 4 ohms	See 1
<ul style="list-style-type: none"> <li>• If measurement is correct replace the Evaporator Temperature Regulator.</li> </ul> 1. Check for an open Low Pressure Cut-Out Switch, High Pressure Cut-Out Switch, A/C Temperature Switch, or associated wiring (see schematic). If High Pressure Cut-Out Switch is open, replace it. If Low Pressure Cut-Out Switch is open, check refrigerant pressure to be sure it is normal before replacing the switch. Replace the A/C Temperature Switch if it is open and engine coolant temperature is below 226 °F (108 °C). If the switches and related wiring is OK, replace the Compressor Clutch.		

**C: EVAPORATOR TEMPERATURE REGULATOR VOLTAGE AND RESISTANCE TEST**

Measure: RESISTANCE At: EVAPORATOR TEMPERATURE REGULATOR CONNECTOR (Disconnected) Conditions: <ul style="list-style-type: none"> <li>• Ignition Switch: OFF</li> <li>• Negative Battery Terminal: DISCONNECTED</li> </ul>		
Measure Between	Correct Resistance	For Diagnosis
1 & Ground	Approximately 3.5K to 4.5K ohms at 70 °F (21 °C)	See 1
4 & Ground	Less than 0.5 ohms	See 2
6 & Ground	Less than 0.5 ohms	See 2
5 & 2	Less than 0.5 ohms	See 3
<ul style="list-style-type: none"> <li>• If all resistances are correct but Compressor Clutch does not operate normally, replace the Evaporator Temperature Regulator.</li> </ul> 1. Check the BK/WT wire for an open or a short to ground (see schematic). Check the BR wire for an open (see schematic). If wires are good, replace the Evaporator Temperature Sensor. 2. Check the BR wire for an open (see schematic). 3. Check BK/YL for an open between terminal 5 and the Low Pressure Cut-Out Switch.		

## 6452-4 COMPRESSOR CONTROLS

### D: IDLE SPEED CONTROL VOLTAGE TEST

Measure: VOLTAGE

At: MOTRONIC CONTROL UNIT  
CONNECTOR (Connected — Universal Adapter)

Conditions:

- Ignition Switch: RUN
- A/C Control Panel: A/C ON
- Temperature Outside Car: Above 60 degrees F (16 degrees C)

Measure Between	Correct Voltage	For Diagnosis
29 BL/WT & Ground	Battery	See 1
<ul style="list-style-type: none"> <li>• If the voltage is correct, repair/replace the Motronic Control Unit.</li> </ul> <ol style="list-style-type: none"> <li>1. Check for an open in the BL/WT and BK/RD wires.</li> </ol>		

### E: A/C SELECT SWITCH VOLTAGE TEST

Measure: VOLTAGE

At: CONTROL SWITCHES CONNECTOR  
(Connected)

Conditions:

- Ignition Switch: RUN
- A/C Control Panel: A/C ON
- Temperature Outside Car: Above 60 degrees F (16 degrees C)

Measure Between	Correct Voltage	For Diagnosis
4 (WT) & Ground	Battery	See 1
2 (BK/VI) & Ground	Battery	See 2
<ul style="list-style-type: none"> <li>• If both voltages are correct, check connections at Evaporator Temperature Regulator.</li> </ul> <ol style="list-style-type: none"> <li>1. Check for an open in the WT and GN/BR wires.</li> <li>2. Replace the A/C Select Switch.</li> </ol>		



# 6454-0 AUXILIARY FAN

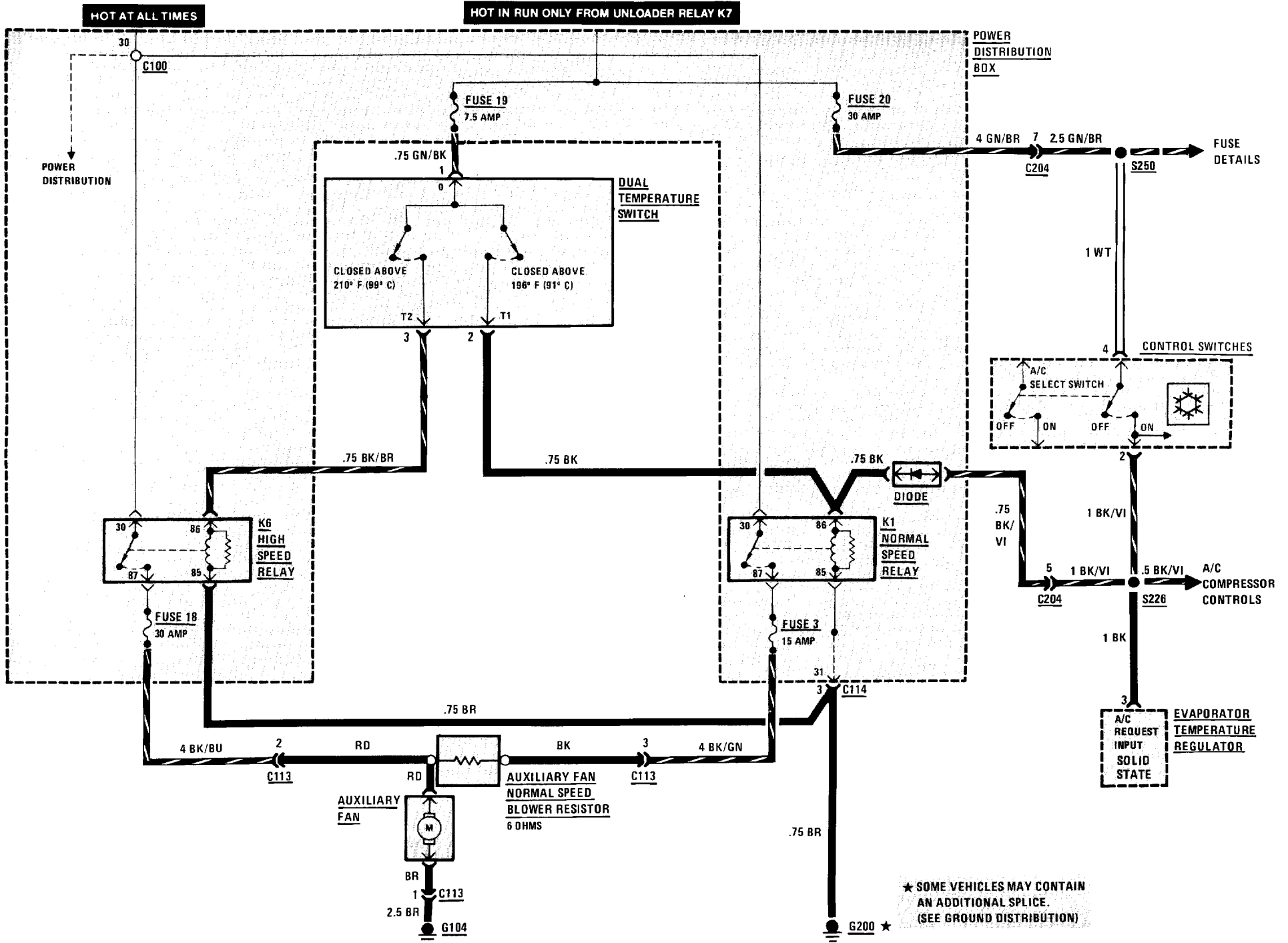

# 6500-0 RADIO/ANTENNA

## EARLY PRODUCTION

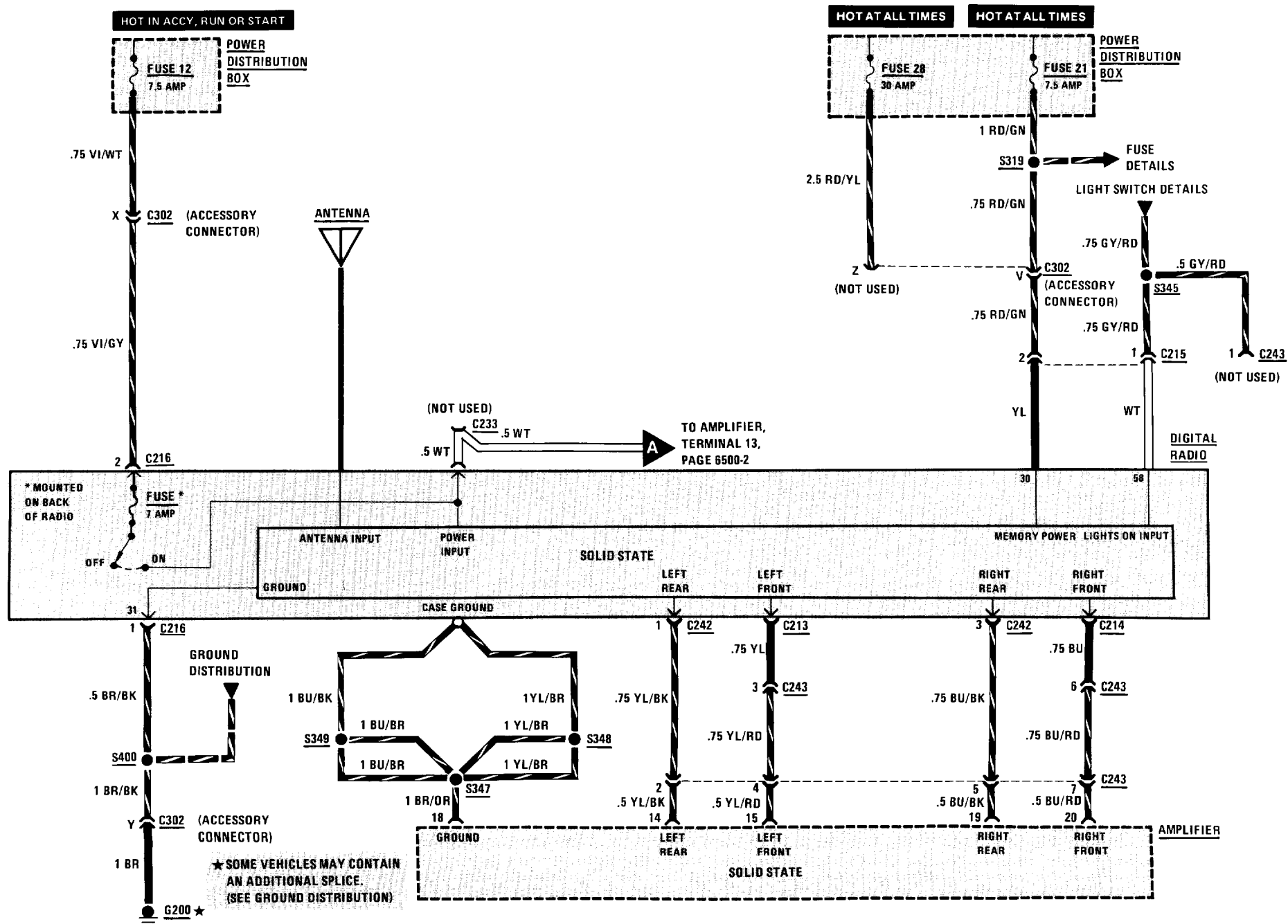

LATE PRODUCTION

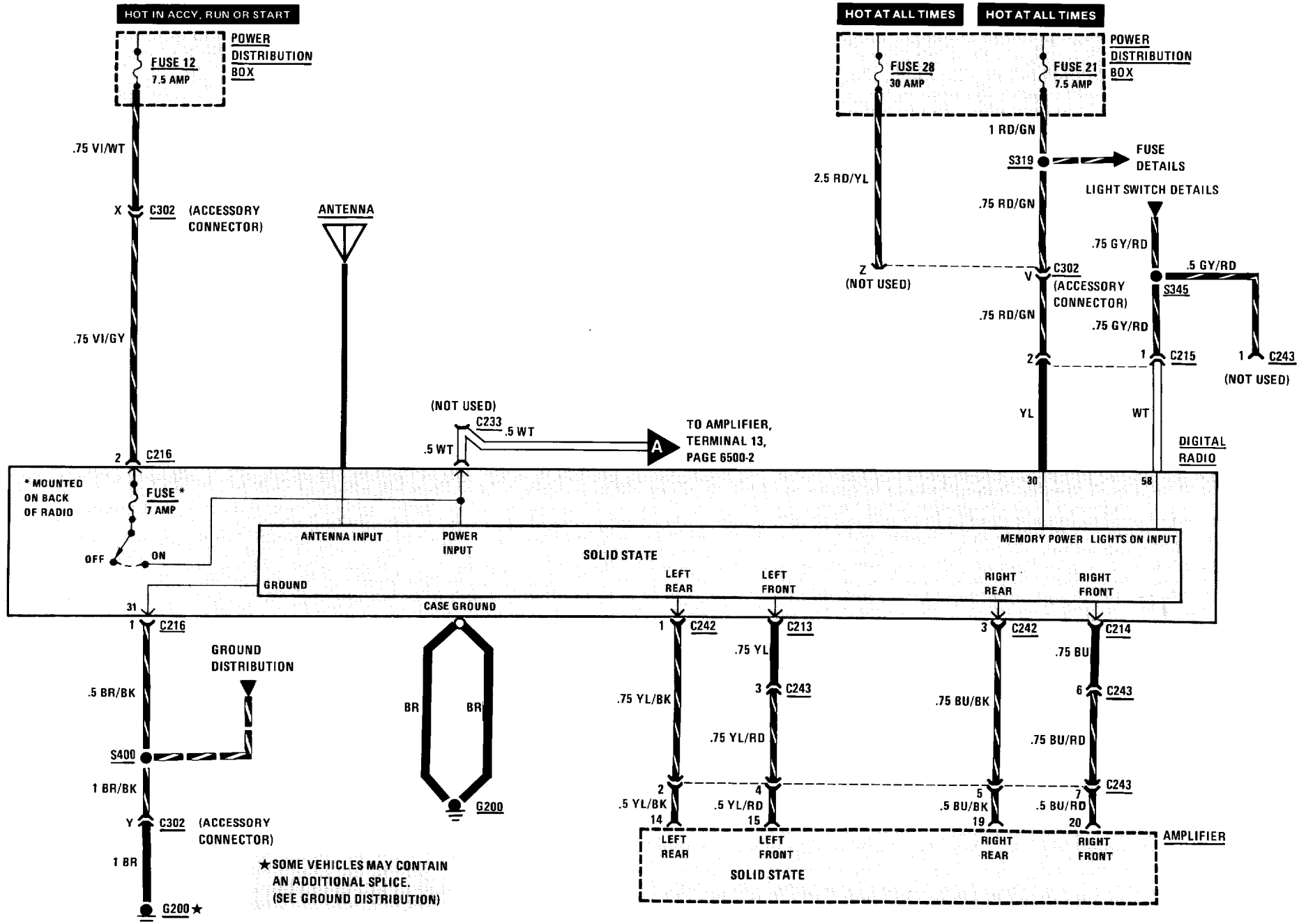



## 6500A-0 RADIO/ANTENNA

### CIRCUIT OPERATION

With the Ignition Switch in ACCY, RUN or START, Fuse 12 provides voltage to turn on the three components in the system. When the Radio Switch is on, voltage is applied to the Radio and the Amplifier. This voltage is used to control the individual unit's main power supply.

Fuse 21 constantly supplies voltage to the Memory Power Input of the Radio. This allows the Radio to maintain the present settings while it is turned off.

The Amplifier receives constant power at terminal 11 from Fuse 27. When the Radio is on, voltage is applied to terminal 13 to enable the Amplifier.

The actual Radio signal originates at the Antenna. It is supplied to the Radio, processed, and output from the Left Channel and Right Channel Outputs. The signal is then input to the Left Front, Left Rear, Right Front and Right Rear Inputs to the Amplifier. After amplification, the signal is output to the corresponding speakers.

### TROUBLESHOOTING HINTS

- Try the following checks before doing the System Check.
1. Check power input to the Radio by observing if Instrument Cluster Indicators light.
  2. Check memory power to Radio by checking operation of the Glove Box Light.
  3. Check power input to the Amplifier.
  4. Check that the Antenna is properly connected.
  5. Before troubleshooting a suspect Speaker, check all connections to that Speaker.
  6. If display shows "CODE" and Radio will not operate, the individual Anti-Theft Code must be entered. Refer to "Anti-Theft" instruction booklet.
  7. Check Radio Fuse located on back of Radio.
  8. Check Amplifier Fuse located on back of Amplifier.
  9. For Radio without Sound System: If a speaker is inoperative, switch with a good speaker. If still inoperative, check related wiring. Remove Radio for service if wiring is OK.

### SYSTEM CHECK

- Use the System Check Table as a guide to normal operation.
- Refer to System Diagnosis for a list of symptoms and diagnostic steps.

**SYSTEM CHECK TABLE**

ACTION	NORMAL RESULT
With Ignition Switch in RUN, turn Radio ON.	Digital display lights. Sound is emitted from all Speakers.
Operate Fader Control.	Sound volume varies from front to rear.

- Refer to System Diagnosis when a result is not normal.

### SYSTEM DIAGNOSIS

- Do the tests listed for your symptom in the Symptom Table below.
- Tests follow the Symptom Table.

**SYMPTOM TABLE**

SYMPTOM	FOR DIAGNOSIS
Radio does not work (no display, no sound).	Do Test A
Digital display lights, but there is no sound.	Do Test B
LH Speakers or RH Speakers do not operate.	Do Test C

(Continued on next page)

(Continued from previous page)

An individual Speaker does not operate.	Do Test D
Excessive noise comes from all speakers.	Do Test E

**A: RADIO POWER TEST**

<b>Measure: VOLTAGE</b> <b>At: RADIO CONNECTOR C216 (Disconnected) or CONNECTOR C215 (Disconnected)</b> <b>Condition:</b> • Ignition Switch: RUN		
Measure Between	Correct Voltage	For Diagnosis
C216 Ground	Battery	See 1
C216/2 & C216/1	Battery	See 2
C215/2 & Ground	Battery	See 3
• If all voltages are correct, check wire from connector C215 to Radio for an open. If wire is OK, remove Radio for service.		
1. Check power input wire for an open.		
2. Check ground wire for an open to ground. Make sure ground G200 is clean and tight.		
3. Check memory power supply wire for an open.		

**B: AMPLIFIER POWER TEST**

<b>Measure: VOLTAGE</b> <b>At: AMPLIFIER CONNECTOR (Disconnected)</b> <b>Conditions:</b> • Ignition Switch: RUN • Radio: ON		
Measure Between	Correct Voltage	For Diagnosis
11 & Ground	Battery	See 1
11 & 18	Battery	See 2
13 & Ground	Battery	See 3
11 & 10	Battery	See 4
• If all voltages are correct, go to Test C.		
1. Check power supply wire for an open.		
2. Check Amplifier ground to Amplifier for an open to ground. Make sure ground G200 is clean and tight.		
3. Check Amplifier "Radio On" wire for an open.		
4. Check wire from terminal 10 for an open to ground. Make sure ground G106 is clean and tight.		

**C: FADER SIGNAL TEST (WITH SOUND SYSTEM)**

<b>Measure: VOLTAGE</b> <b>At: AMPLIFIER CONNECTOR (Disconnected)</b> <b>Conditions:</b> • Ignition Switch: RUN • Radio: ON		
Measure Between	Correct Voltage	For Diagnosis
14 & Ground	Approximately 6 Volts	See 1
15 & Ground	Approximately 6 Volts	See 1
19 & Ground	Approximately 6 Volts	See 1
20 & Ground	Approximately 6 Volts	See 1
• If all voltages are correct but sound was not present, remove Amplifier for service.		
1. Check between Radio and Amplifier for an open in the wiring. If wire is OK, remove Radio for service.		

## 6500A-2 RADIO/ANTENNA

### D: SUSPECT SPEAKER TEST

Connect: OHMMETER

At: SUSPECT SPEAKER (Disconnected) d)

- Ohmmeter set on Rx 1 scale or Diode Check Scale

Action	Correct Result	For Diagnosis
Connect Ohmmeter across Speaker Terminals	Speaker "pops"	See 1

- If the result is correct, check wires to the Amplifier or Radio for opens or shorts. If OK, check wires between Amplifier (if equipped) and the Radio. Remove Radio for service.

1. Replace the suspect Speaker.

### E: NOISE DIAGNOSIS

With Radio on and noise present, unplug the Antenna at the back of the Radio.

- If noise is no longer present, it was being picked up by the Antenna. Perform Antenna Noise Test.
- If noise persists, it is coming in the Radio wiring. Refer to the following Noise Symptom Table.

### ANTENNA NOISE TEST

Measure: RESISTANCE

At: ANTENNA

Measure Between	Correct Resistance	For Diagnosis
Antenna Plug Base & Ground	Less than 3 Ohms	See 1
Antenna Plug Tip & Antenna Plug Base	Greater than 1 Megohm (open circuit)	See 2

- If both resistances are correct, check the hood ground strap. If OK, substitute different Antenna at Radio. If good, replace Antenna. If noise is still present, refer to Noise Symptom Table.

1. Check ground contact at Antenna base. If necessary, install a braided ground strap from the Antenna Base to Chassis ground. Check for an open in the Antenna Cable.
2. Check for a short to ground at the Antenna or Antenna cable.

**NOISE SYMPTOM TABLE**

SYMPTOM	POSSIBLE CAUSE	REPAIR ACTION
Harsh popping or crackling noise present when ignition on-changes with engine rpm.	Ignition Noise	<ul style="list-style-type: none"> <li>• Check for proper distributor cap shielding.</li> <li>• Check shielding ground strap. If not present, install.</li> <li>• Check for defective spark plug or spark plug wire.</li> <li>• Reroute spark plug wires laying against anything that could be transmitting noise to the Radio (wiring or sensor leads traveling into the passenger compartment).</li> <li>• Check engine/firewall ground strap and engine hood/body ground strap.</li> <li>• Check if engine hood is closing properly.</li> <li>• Connect dedicated ground strap to Radio.</li> <li>• Replace distributor cap and rotor.</li> </ul>
High whine or howling that changes with engine rpm.	Alternator noise	<ul style="list-style-type: none"> <li>• Connect dedicated ground strap to Radio.</li> <li>• Run a direct wire from Battery to Alternator.</li> </ul>
AM only is weak and noisy.	AM alignment	<ul style="list-style-type: none"> <li>• Remove Radio for service.</li> </ul>
FM only is weak and noisy.	FM alignment	<ul style="list-style-type: none"> <li>• Remove Radio for service.</li> </ul>





# 6581-0 ON-BOARD COMPUTER

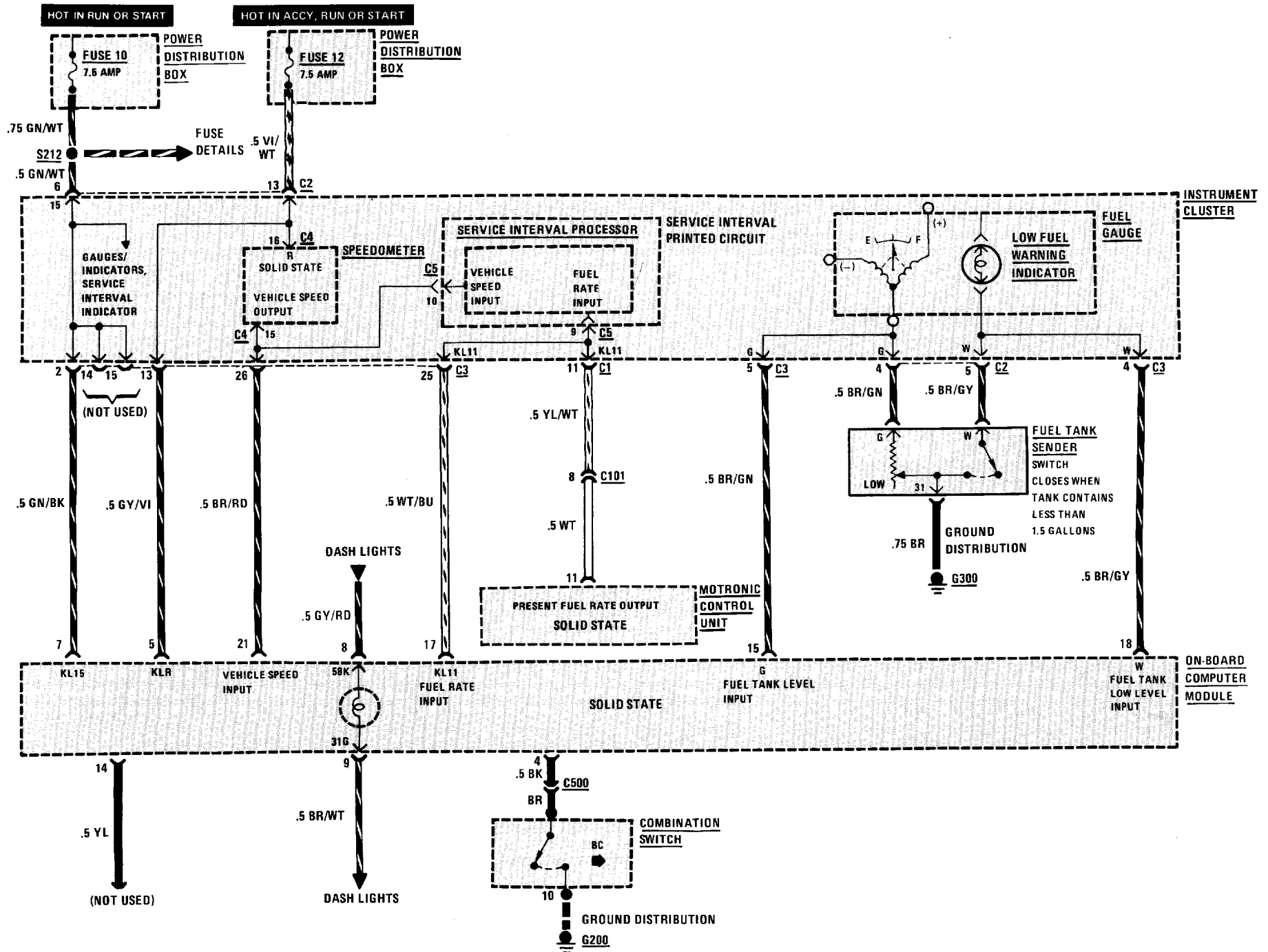

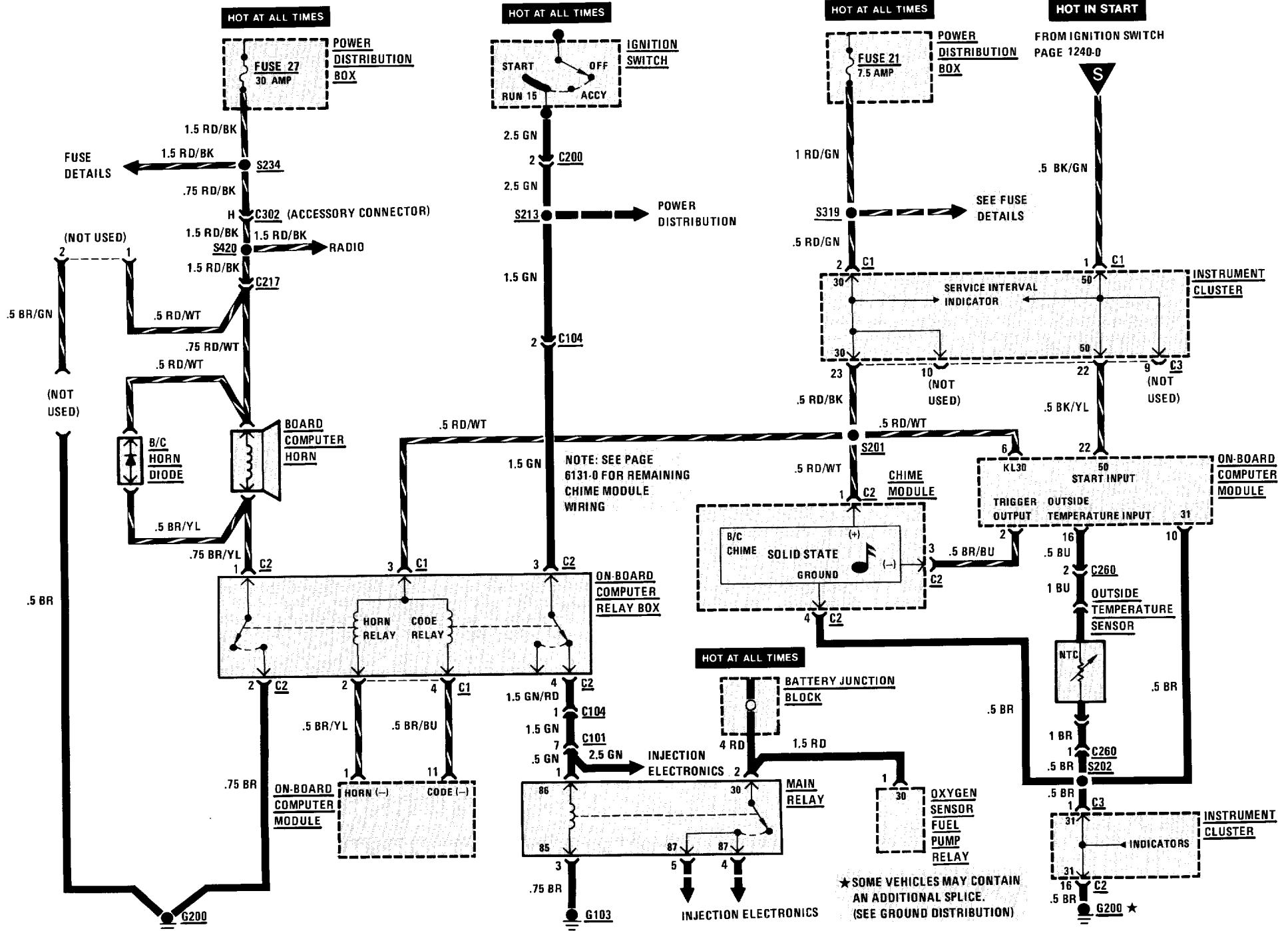

# 7000-0 COMPONENT LOCATION VIEWS

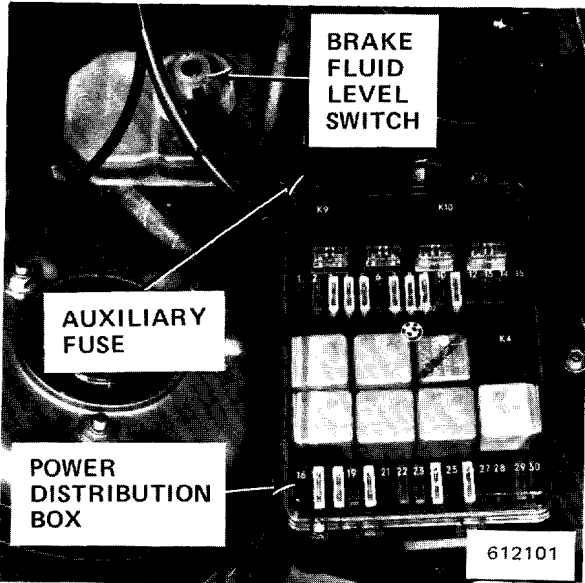

Figure 1 - LH Rear Corner of Engine Compartment

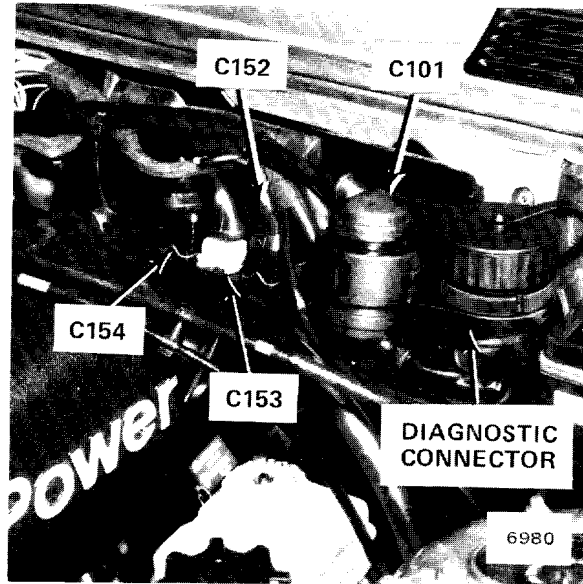

Figure 3 - LH Rear of Engine Compartment

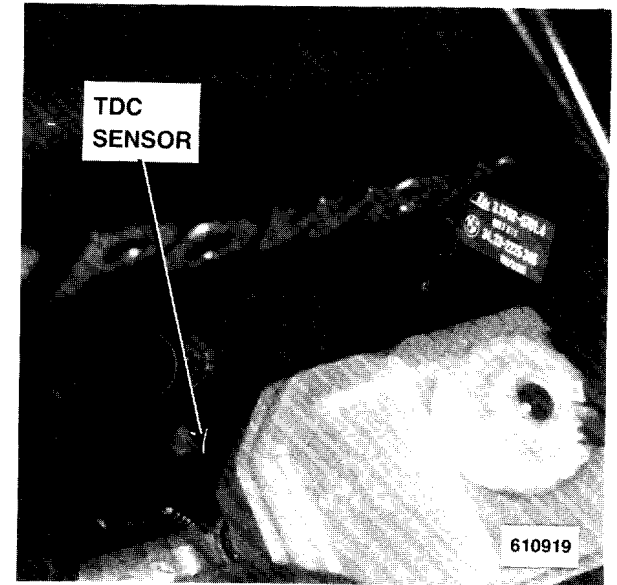

Figure 5 - Lower LH Rear of Engine

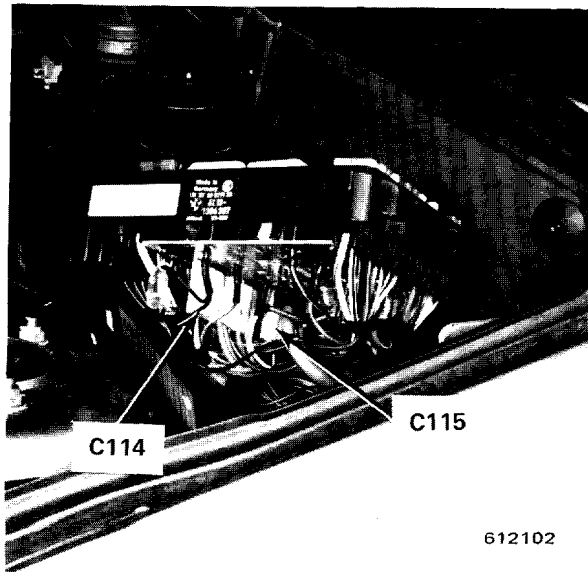

Figure 2 - LH Rear Corner of Engine Compartment (Inside Power Distribution Box)

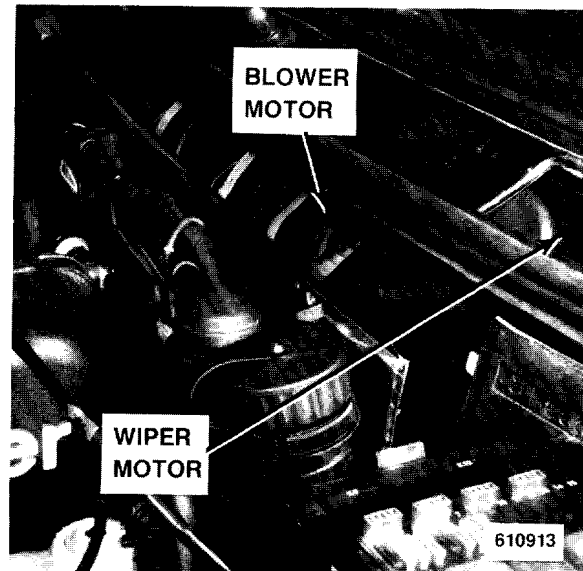

Figure 4 - LH Rear of Engine Compartment

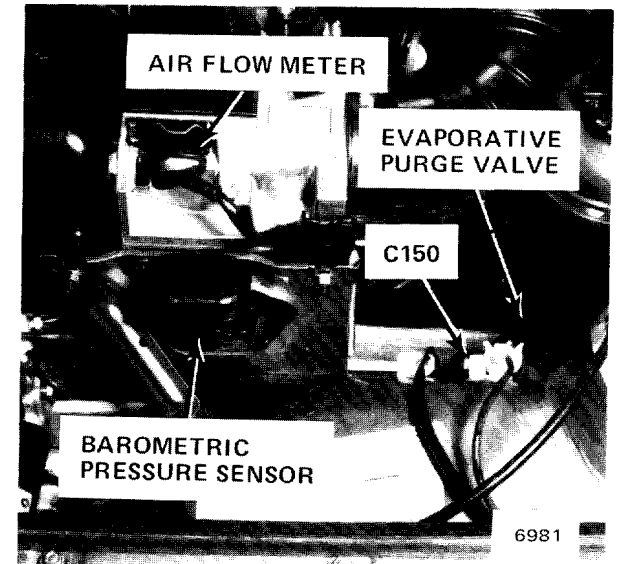

Figure 6 - LH Front of Engine Compartment

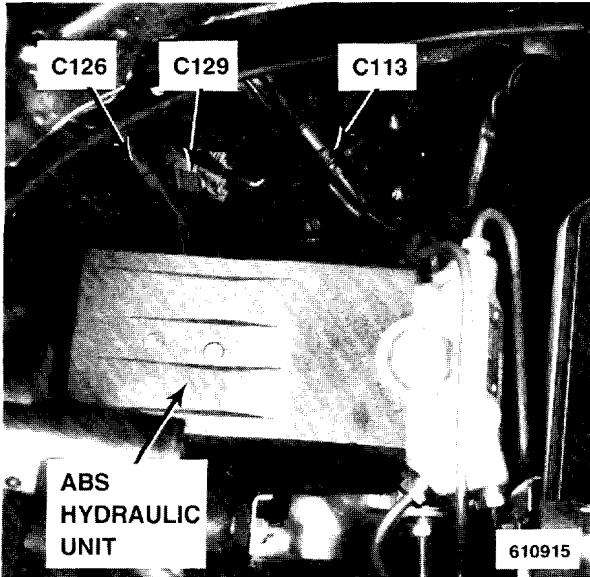

Figure 1 - LH Front Corner of Engine Compartment



Figure 3 - LH Front Corner of Engine Compartment

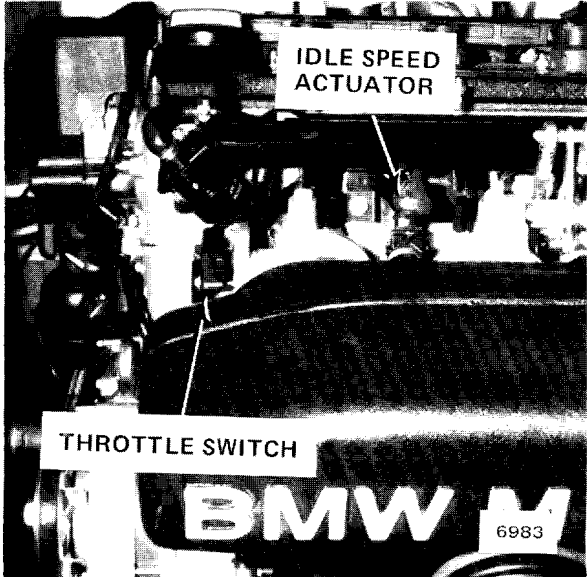

Figure 5 - Top Front Center of Engine



Figure 2 - Lower LH Front of Engine

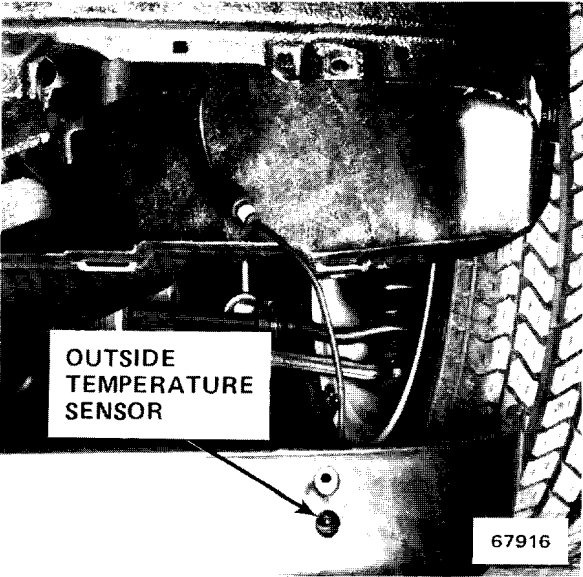

Figure 4 - Under LH Side of Bumper (Splash Guard Pulled Down)

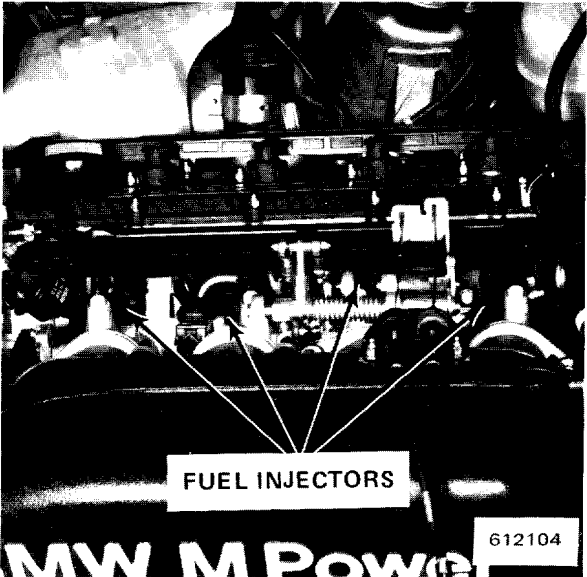

Figure 6 - Top of Engine

# 7000-2 COMPONENT LOCATION VIEWS

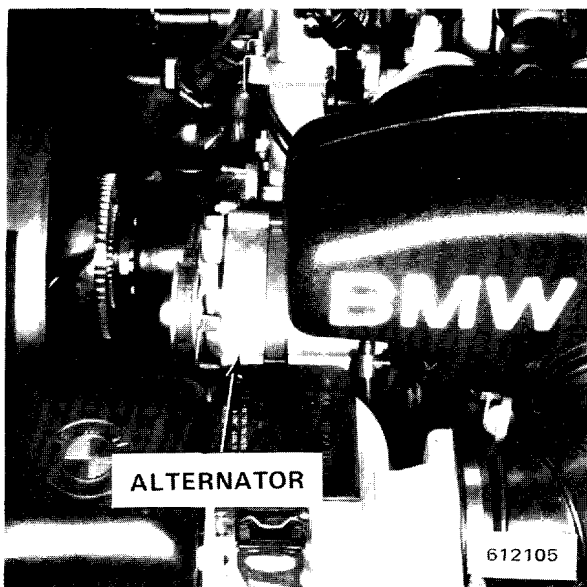

Figure 1 - LH Front of Engine Compartment

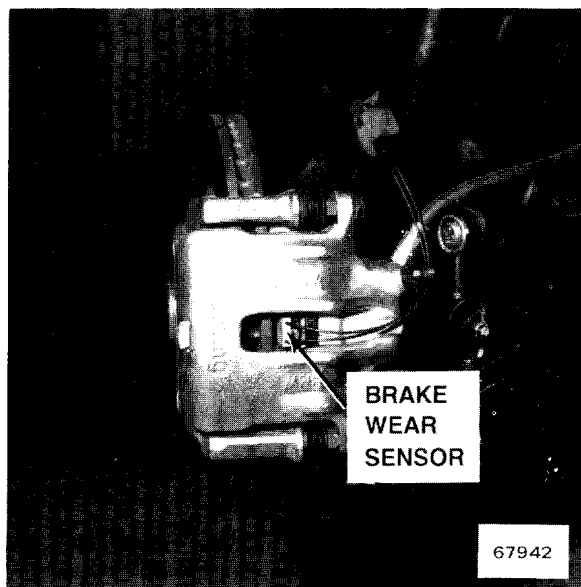

Figure 3 - LH Front Brake Assembly (Wheel Removed)



Figure 5 - Behind Middle of Front Bumper

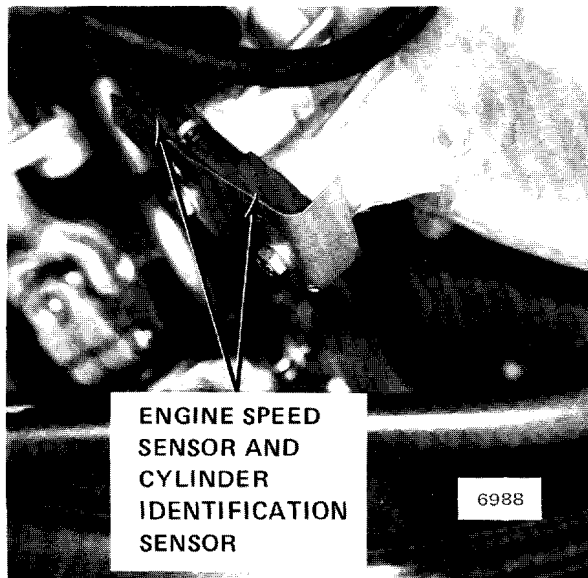

Figure 2 - LH Side of Transmission Bell Housing

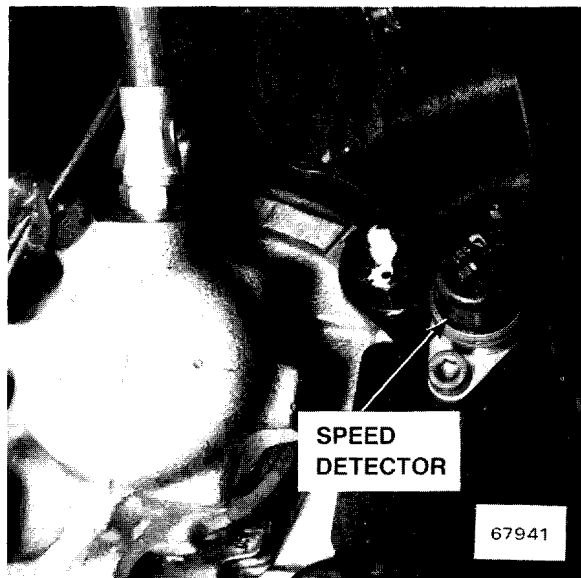

Figure 4 - LH Front Spindle Assembly

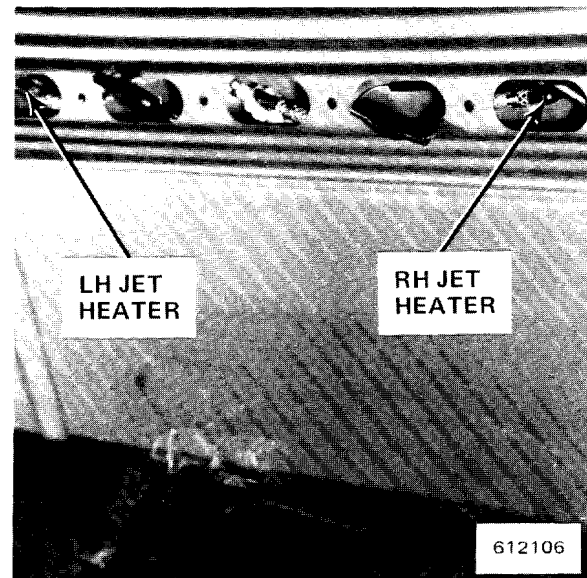

Figure 6 - Center of Engine Compartment Hood

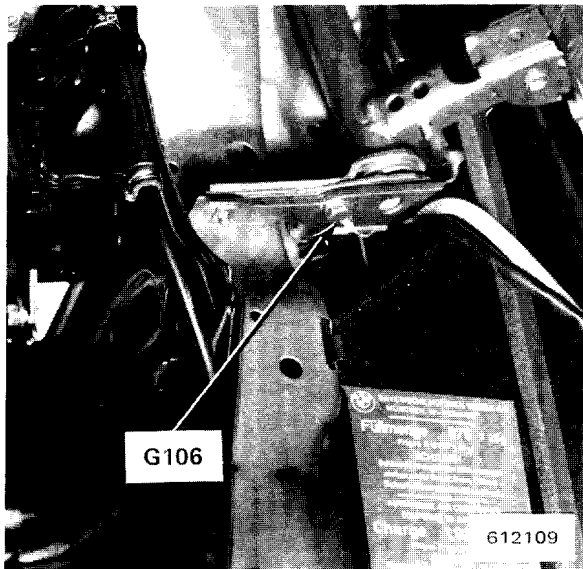

Figure 1 - RH Front Corner of Engine Compartment

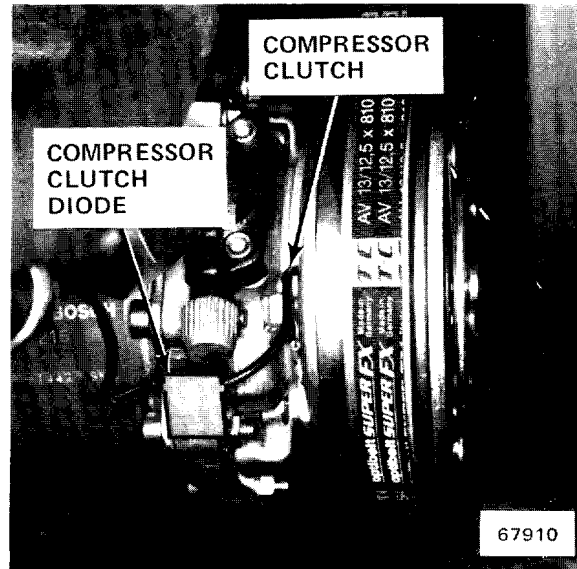

Figure 3 - Lower RH Front of Engine

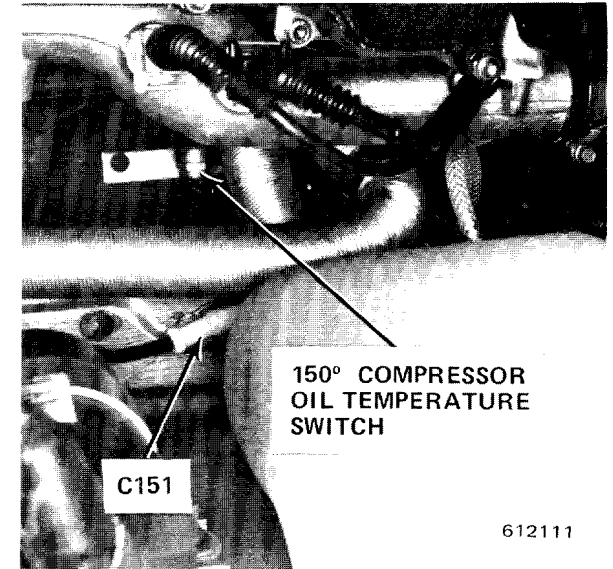

Figure 5 - Lower RH Front Center of Engine Compartment

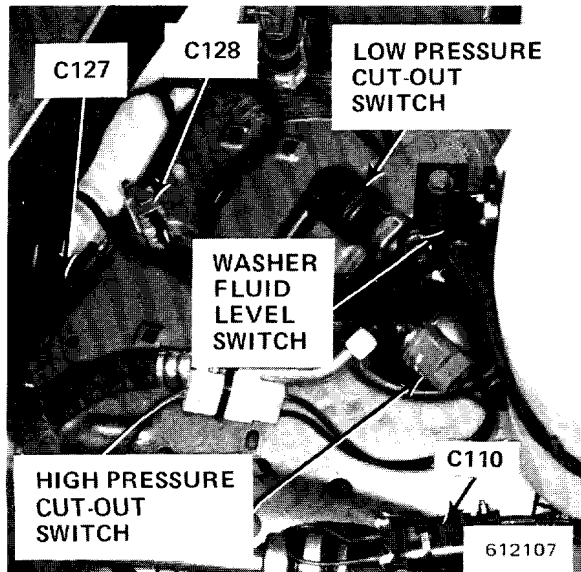

Figure 2 - RH Front Corner of Engine Compartment

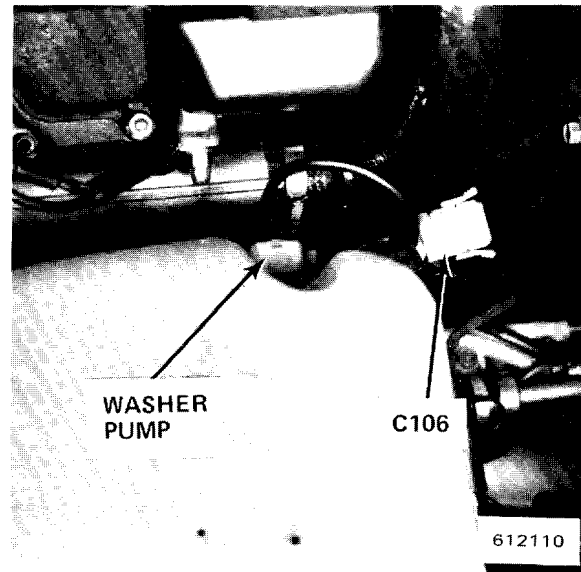

Figure 4 - RH Front Corner of Engine Compartment

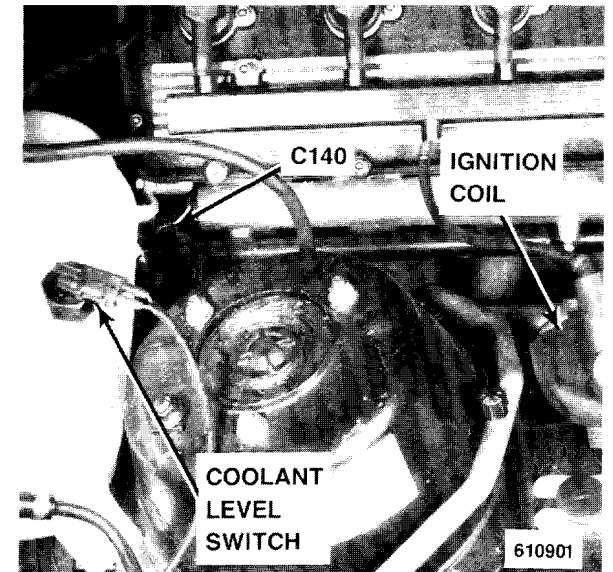

Figure 6 - RH Side of Engine Compartment

## 7000-4 COMPONENT LOCATION VIEWS

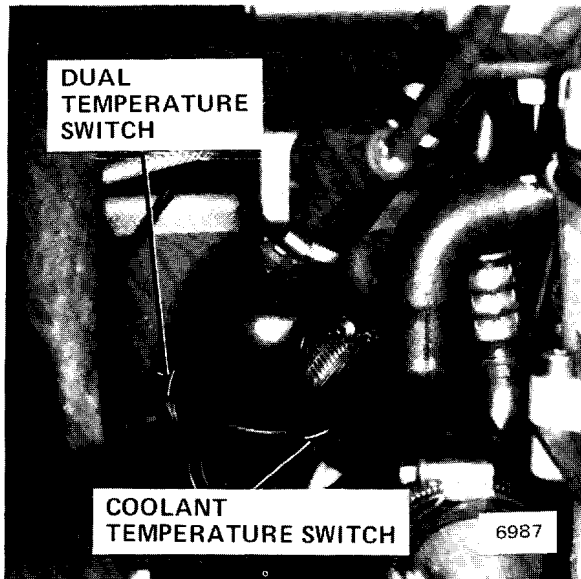

Figure 1 - Lower RH Side of Engine Compartment

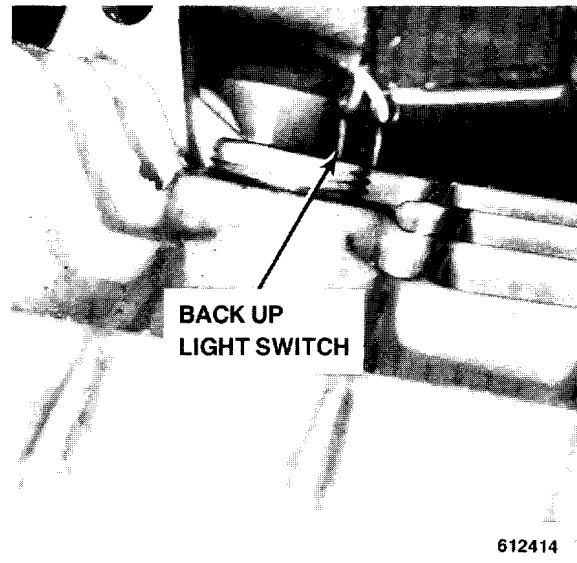

Figure 3 - Lower RH Rear of Engine Compartment



Figure 5 - Top RH Side of Transmission

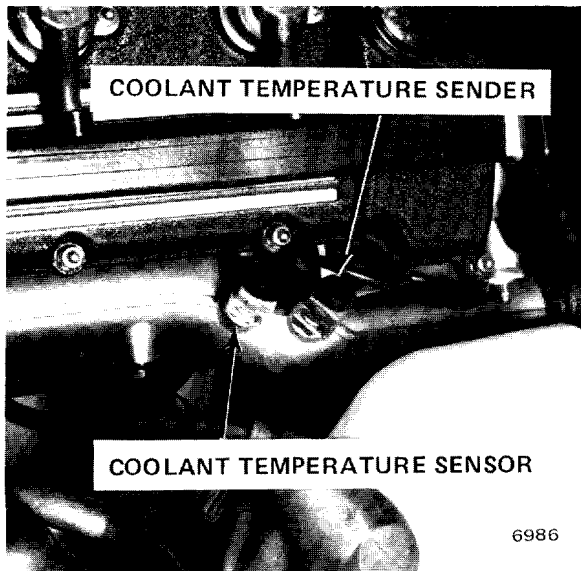

Figure 2 - RH Front Side of Engine Compartment

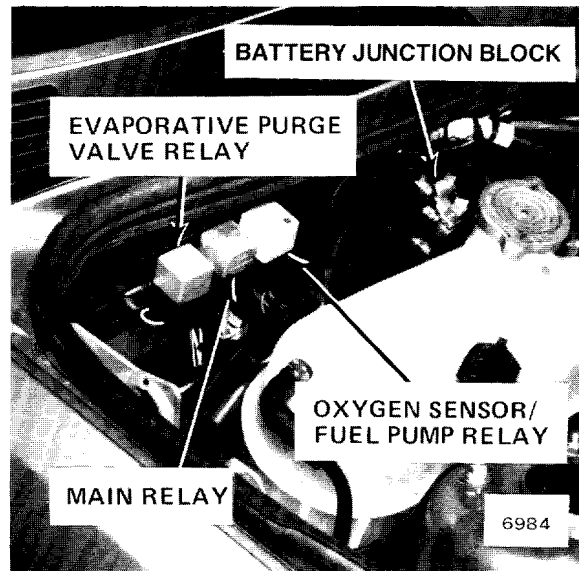

Figure 4 - RH Rear Corner of Engine Compartment

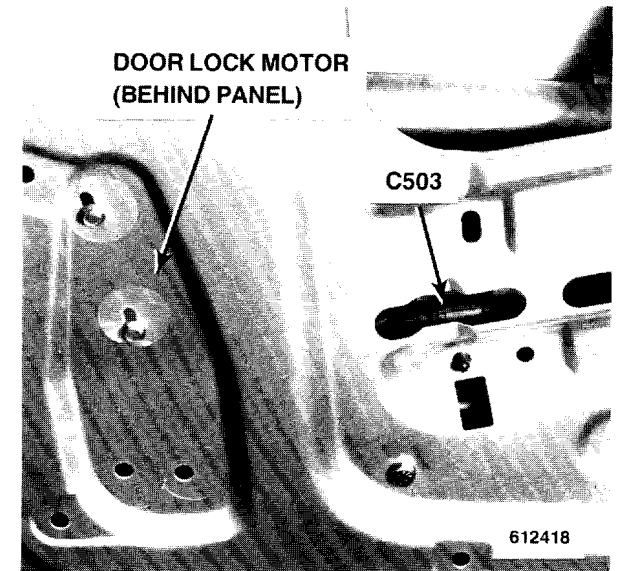

Figure 6 - Rear of LH Door



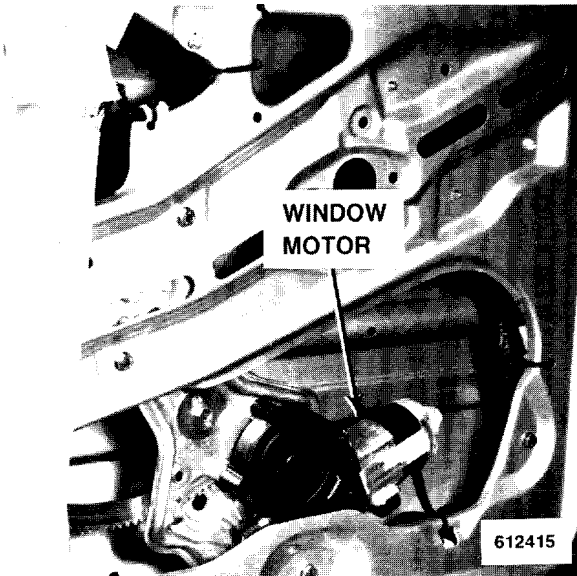

Figure 1 - Lower Front of LH Door

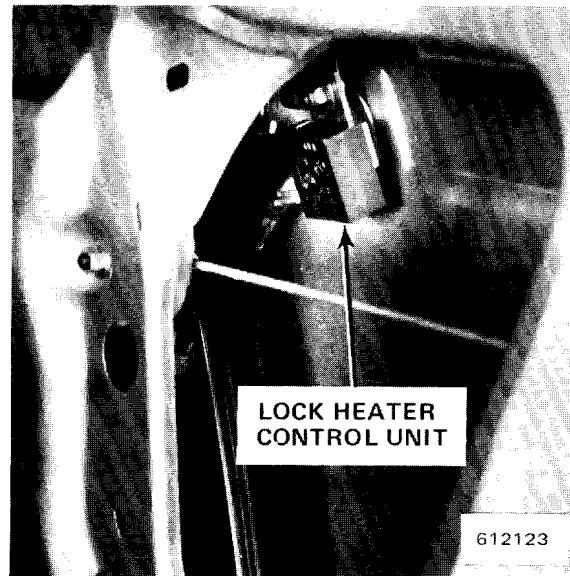

Figure 3 - Top Rear of LH Door



Figure 5 - Behind LH Side of Dash

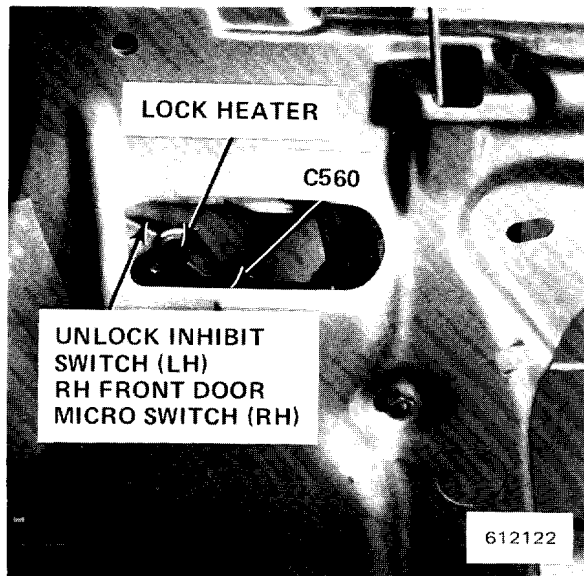

Figure 2 - Top Rear of LH Door

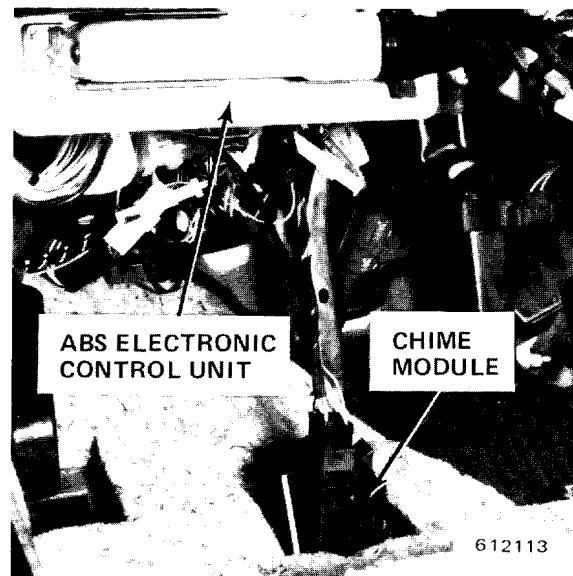

Figure 4 - Behind LH Side of Dash

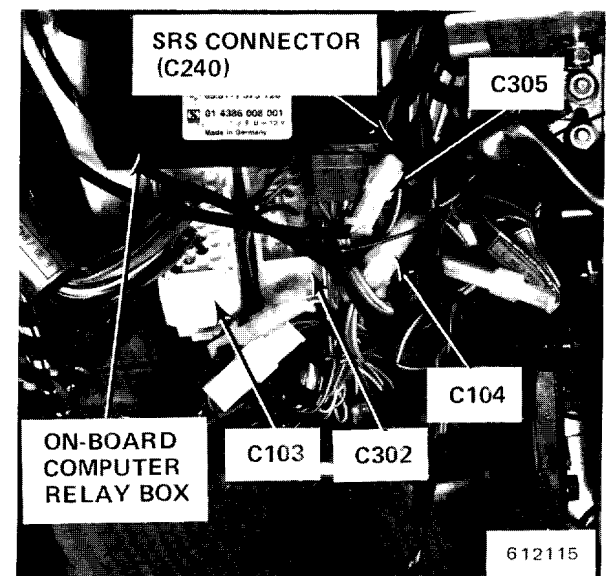

Figure 6 - Behind LH Side of Dash (ABS Electronic Control Unit Dropped)

# 7000-6 COMPONENT LOCATION VIEWS

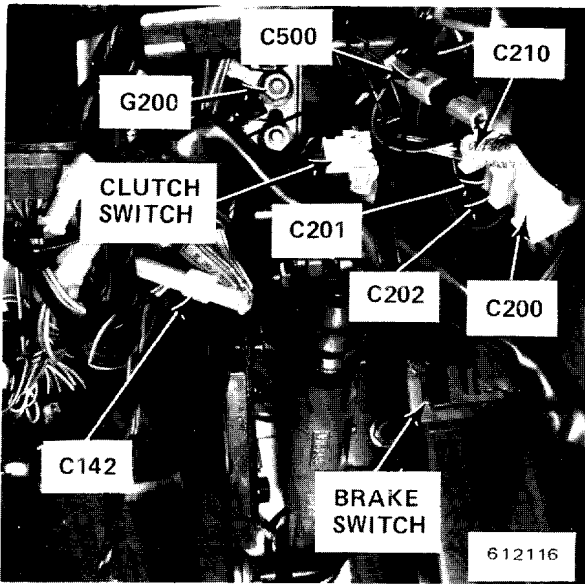

Figure 1 - Behind LH Side of Dash (ABS Electronic Control Unit Dropped)

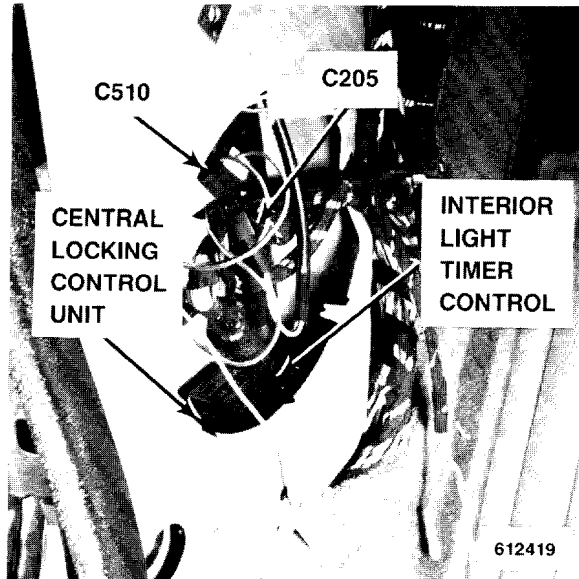

Figure 3 - Behind LH Front Speaker

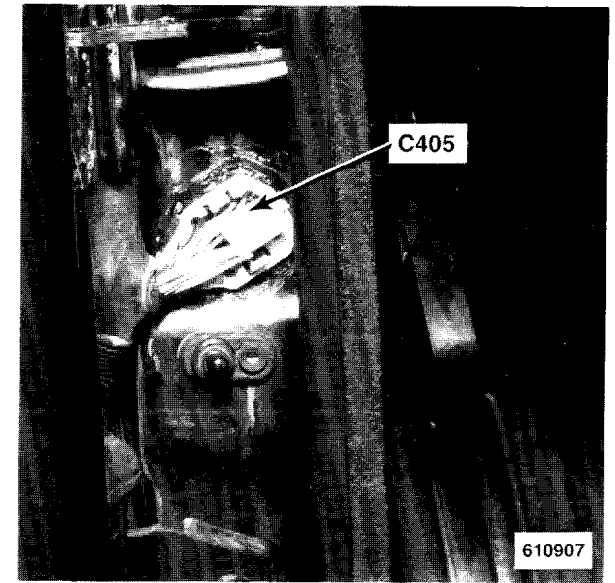

Figure 5 - LH Door Jamb

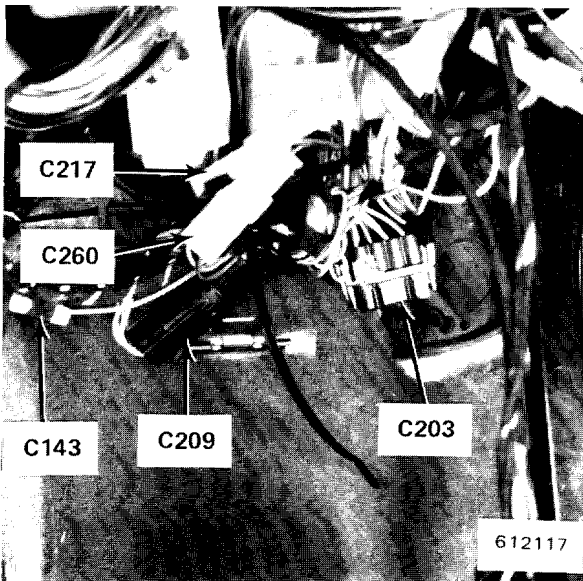

Figure 2 - Behind LH Side of Dash

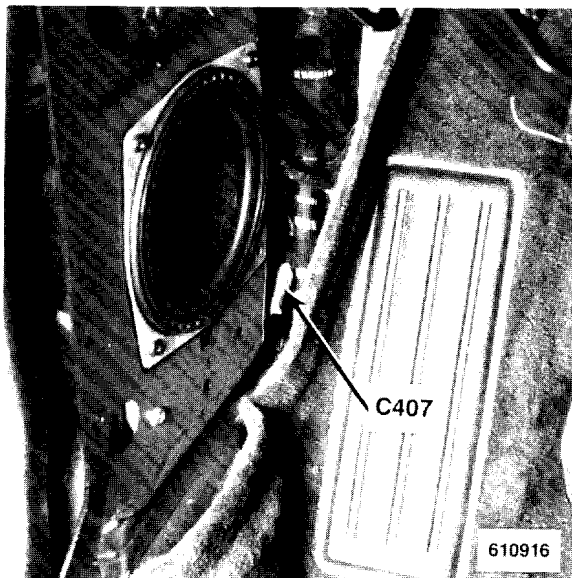

Figure 4 - LH Kick Panel



Figure 6 - Behind LH Side of Dash

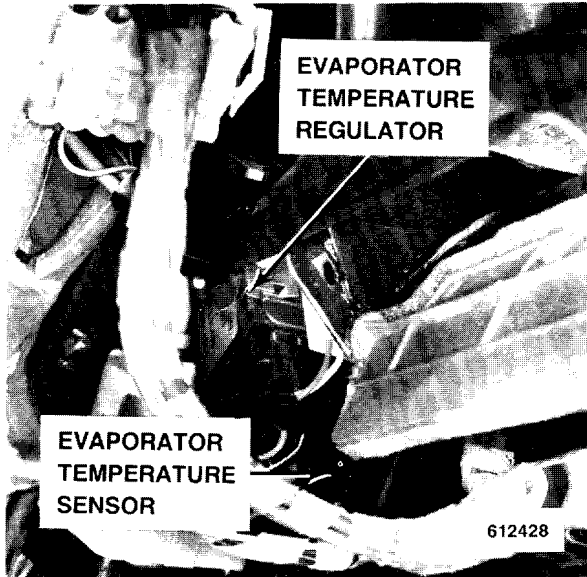

Figure 1 - LH Side of Evaporator Housing

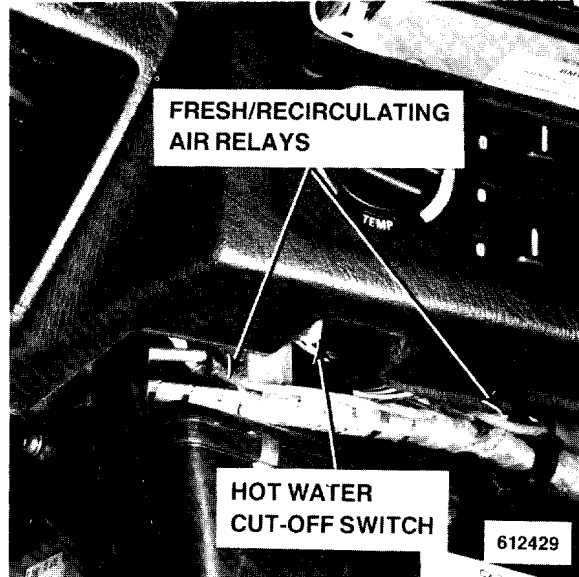

Figure 3 - Behind Center of Dash

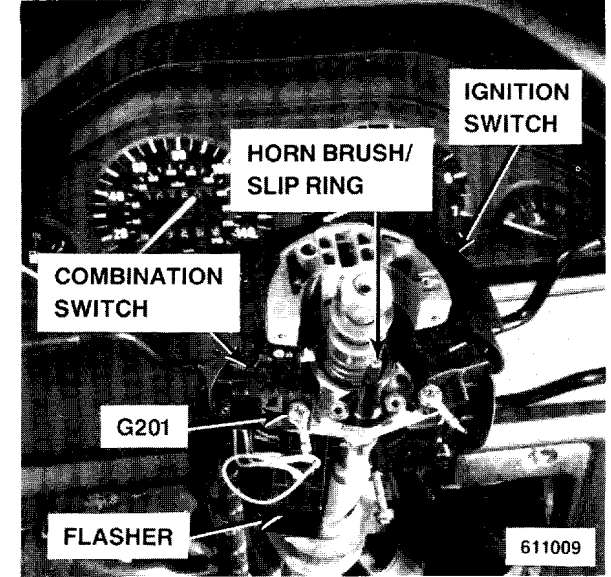

Figure 5 - Steering Column



Figure 2 - LH Side of Evaporator Housing



Figure 4 - LH Side of Evaporator Housing

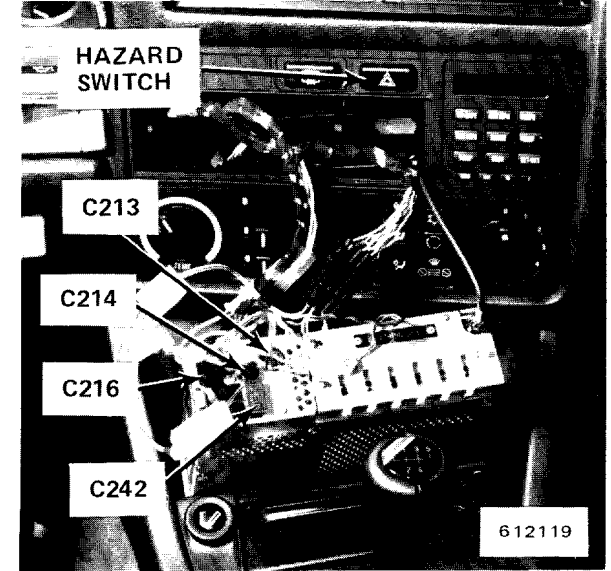

Figure 6 - Behind Center of Dash

# 7000-8 COMPONENT LOCATION VIEWS

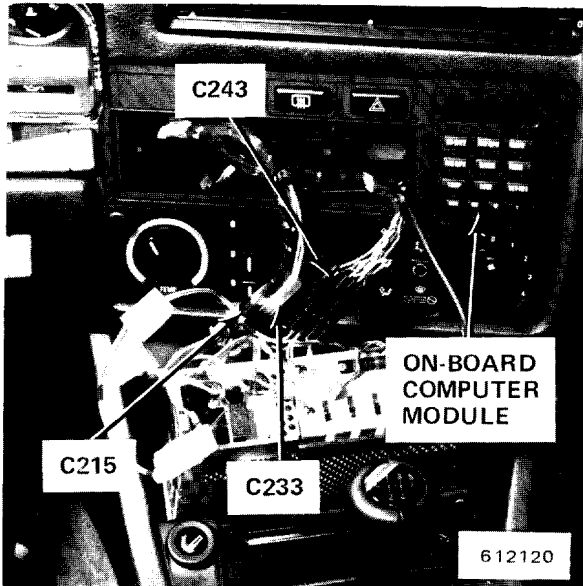

Figure 1 - Behind Center of Dash

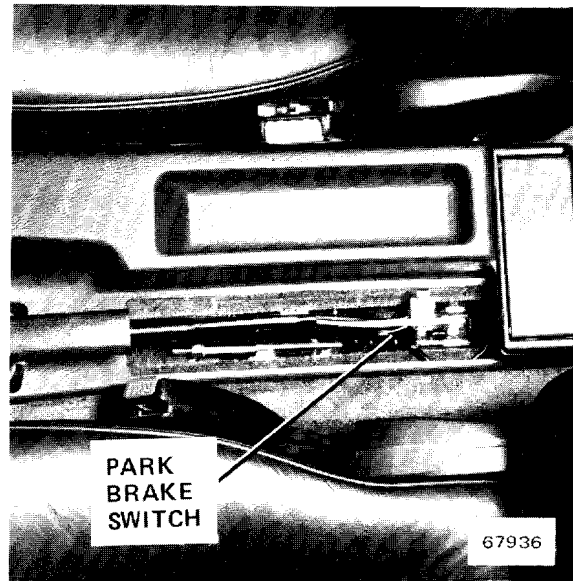

Figure 3 - Rear of Center Console

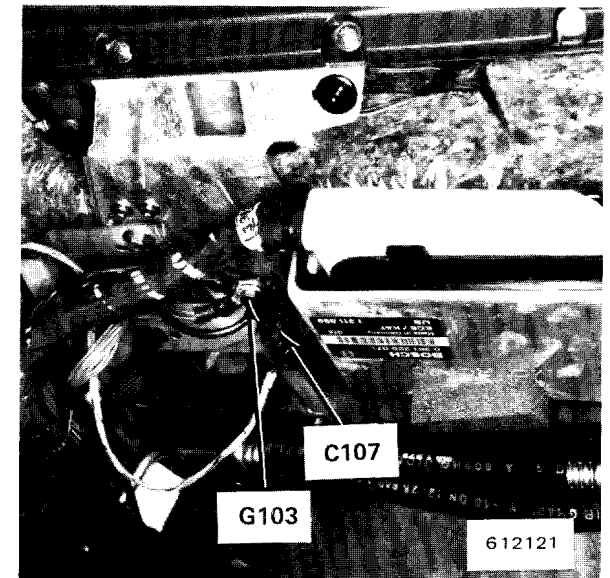

Figure 5 - Behind RH Side of Dash

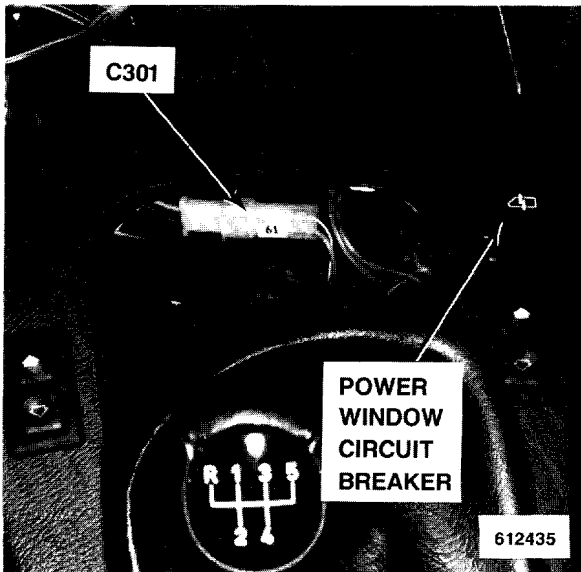

Figure 2 - Under Center Console

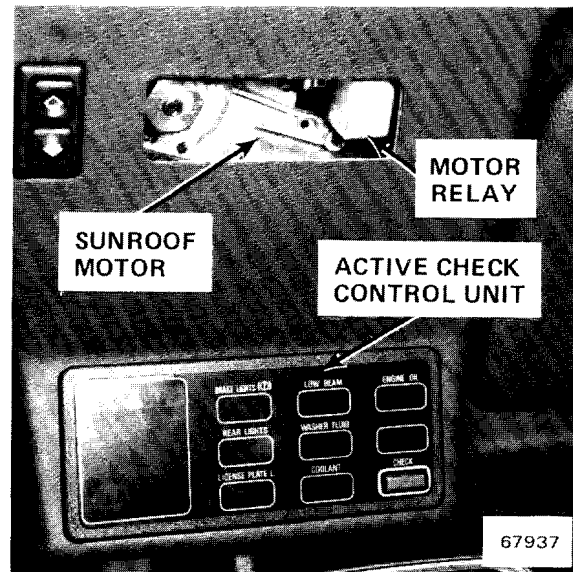

Figure 4 - Above Rear View Mirror

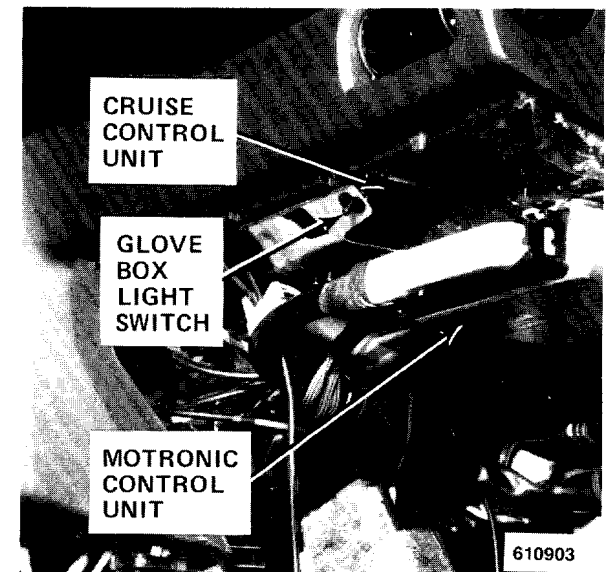

Figure 6 - Behind RH Side of Dash

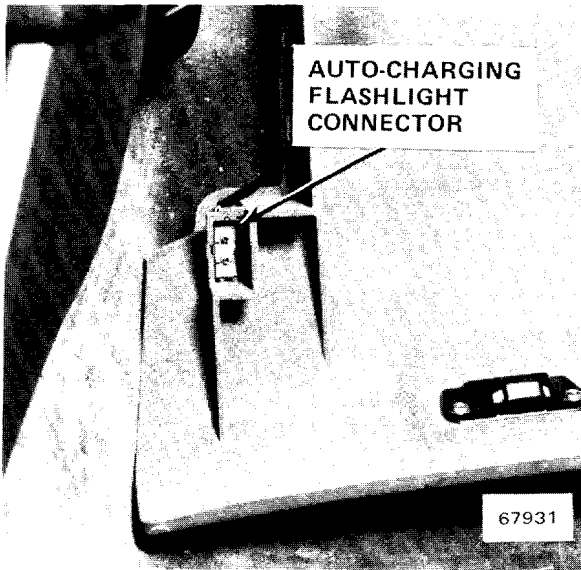

Figure 1 - Inside Glove Box

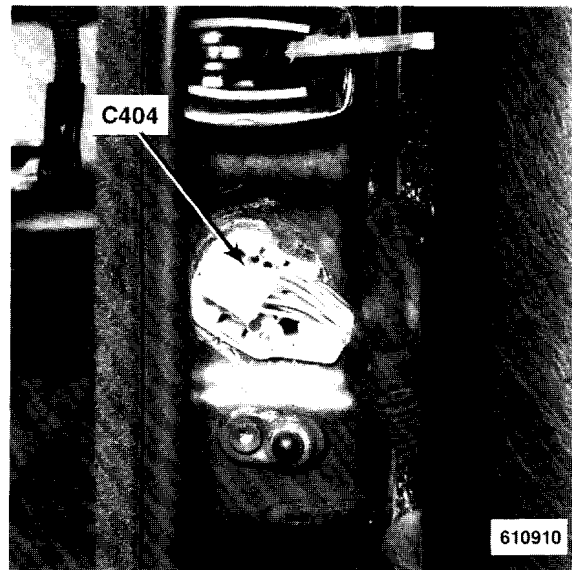

Figure 3 - RH Front Door Jamb

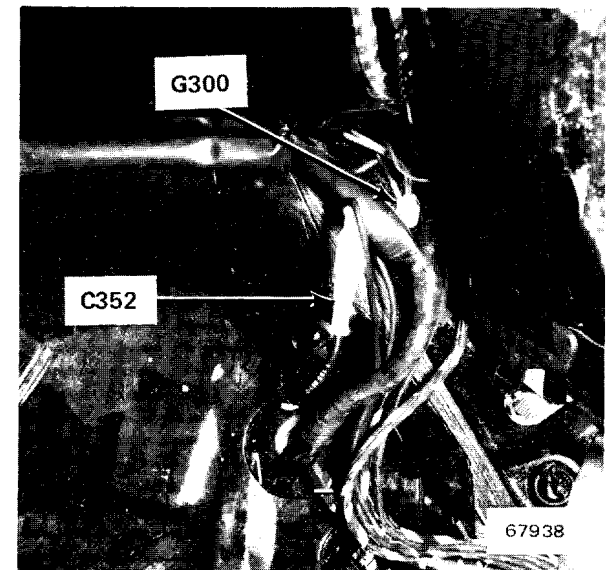

Figure 5 - Under LH Side of Rear Seat

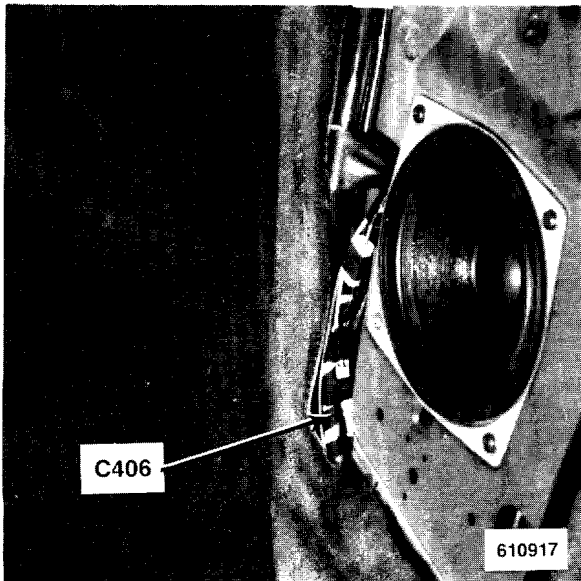

Figure 2 - RH Kick Panel

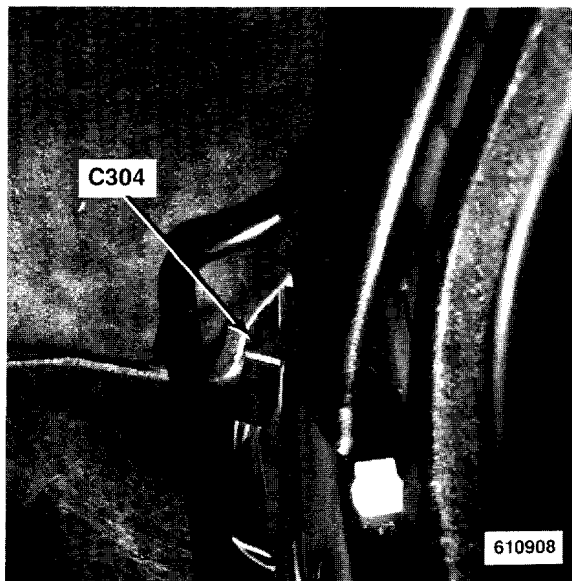

Figure 4 - Base of LH "B" Pillar

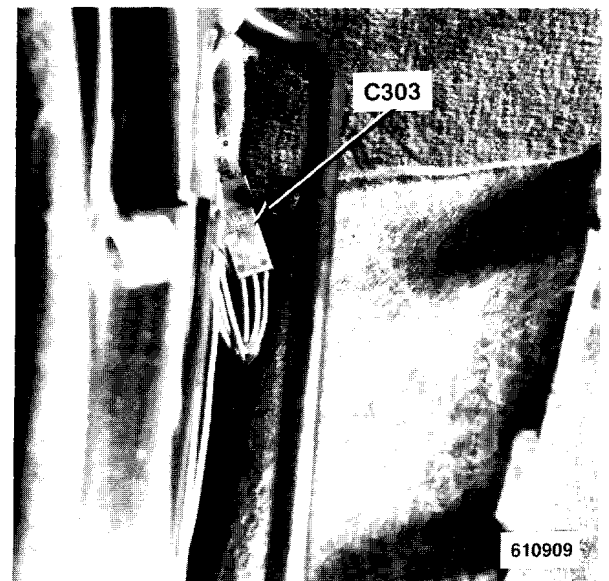

Figure 6 - Base of RH "B" Pillar

# 7000-10 COMPONENT LOCATION VIEWS

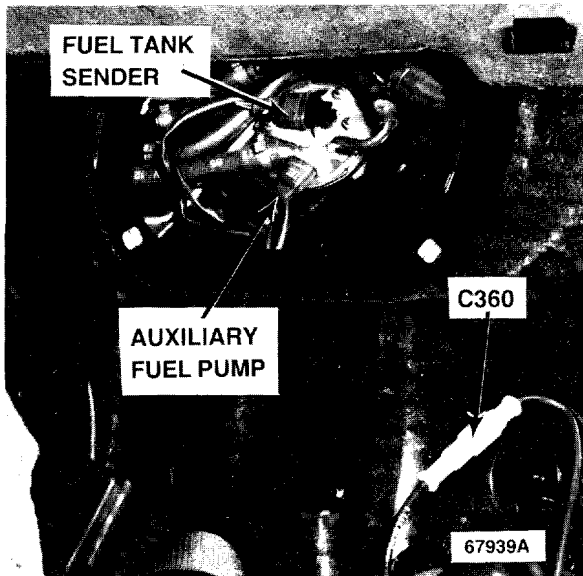

Figure 1 - Under RH Side of Rear Seat

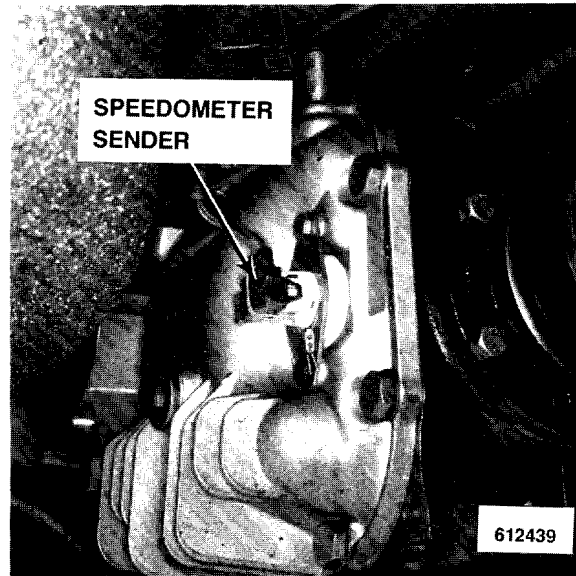

Figure 3 - RH Rear of Differential



Figure 5 - Center of Trunk

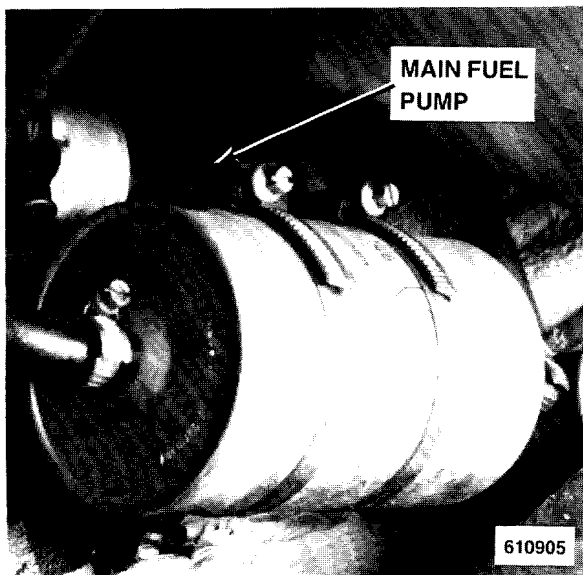

Figure 2 - Under Car, in Front of LH Rear Wheel

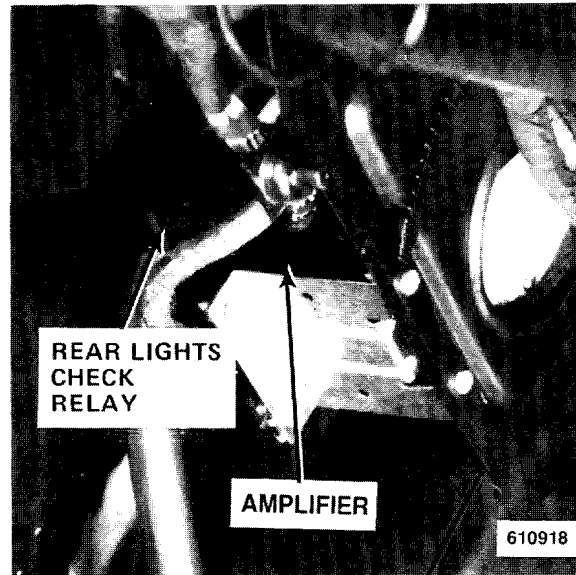

Figure 4 - LH Side of Trunk

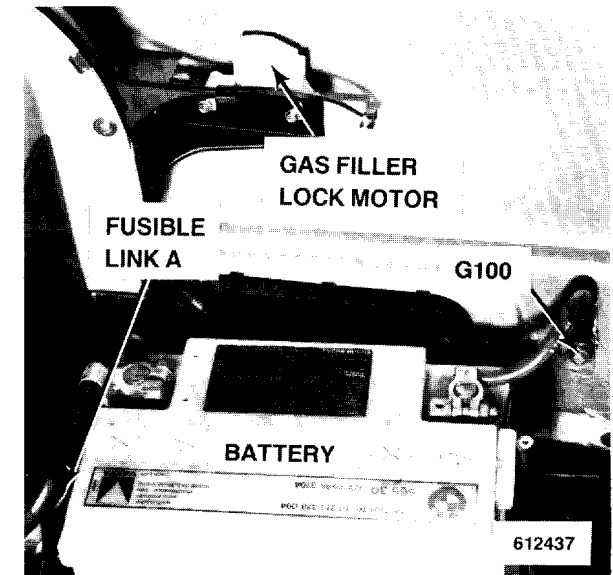

Figure 6 - RH Side of Trunk

TRUNK LIGHT  
SWITCH

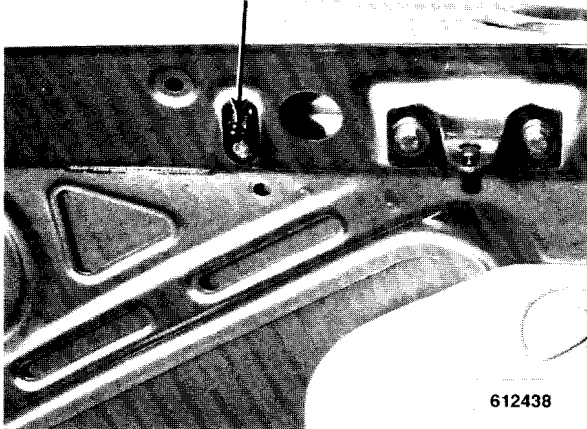

Figure 1 - Top Center of Trunk Lid

## 8000-0 SPLICE LOCATION VIEWS

### INDEX

This index contains all the splices in the car, what harness each one is in, and the page that the splices appear on. The drawings after the index show how the harness is routed through the car and where the splices are located on the harness.

SPLICE	HARNESS	PAGE NUMBER	SPLICE	HARNESS	PAGE NUMBER
S100	MAIN	8000-1	S239	MAIN	8000-1
S102	MAIN	8000-1	S240	A/C	NOT SHOWN
S103	MAIN	8000-1	S241	CRUISE CONTROL	NOT SHOWN
S104	ENGINE (S14)	8000-2	S242	MAIN	NOT SHOWN
S105	ENGINE (S14)	8000-2	S250	A/C	NOT SHOWN
S106	ENGINE (S14)	8000-2	S251	A/C	NOT SHOWN
S107	ENGINE (S14)	8000-2	S252	A/C	NOT SHOWN
S108	ENGINE (S14)	8000-2	S300	DOOR	8000-3
S112	ENGINE (S14)	8000-2	S301	DOOR	8000-3
S114	MAIN	8000-1	S302	DOOR	8000-3
S115	MAIN	8000-1	S303	DOOR	8000-3
S116	MAIN	8000-1	S304	DOOR	8000-3
S118	MAIN	8000-1	S305	DOOR	8000-3
S119	MAIN	8000-1	S306	INSTRUMENT PANEL	8000-4
S125	JET HEATER	NOT SHOWN	S307	INSTRUMENT PANEL	8000-4
S126	JET HEATER	NOT SHOWN	S309	DOOR	8000-3
S150	ENGINE (S14)	8000-2	S310	MAIN	8000-1
S151	ENGINE (S14)	8000-2	S316	MAIN	8000-1
S201	ON-BOARD COMPUTER	8000-5	S319	MAIN	8000-1
S202	ON-BOARD COMPUTER	8000-5	S322	DOOR	8000-3
S203	MAIN	8000-1	S324	MAIN	8000-1
S207	MAIN	8000-1	S326	MAIN	8000-1
S209	MAIN	8000-1	S329	MAIN	8000-1
S210	MAIN	8000-1	S330	MAIN	8000-1
S211	MAIN	8000-1	S332	DOOR	8000-3
S212	MAIN	8000-1	S333	DOOR	8000-3
S213	MAIN	8000-1	S340	MAIN	8000-1
S215	MAIN	8000-1	S341	MAIN	8000-1
S219	INSTRUMENT PANEL	8000-4	S342	DOOR	8000-3
S221	INSTRUMENT PANEL	8000-4	S345	RADIO	NOT SHOWN
S223	CRUISE CONTROL	NOT SHOWN	S400	RADIO	NOT SHOWN
S226	A/C	NOT SHOWN	S403	RADIO	NOT SHOWN
S228	CRUISE CONTROL	NOT SHOWN	S404	RADIO	NOT SHOWN
S229	AIR CONDITIONING	NOT SHOWN	S411	DOOR	8000-3
S230	MAIN	8000-1	S501	DOOR	8000-3
S231	MAIN	8000-1	S502	DOOR	8000-3
S232	MAIN	8000-1	S503	DOOR	8000-3
S233	MAIN	8000-1	S504	DOOR	8000-3
S234	MAIN	8000-1			



MAIN HARNESS SPLICE LOCATIONS

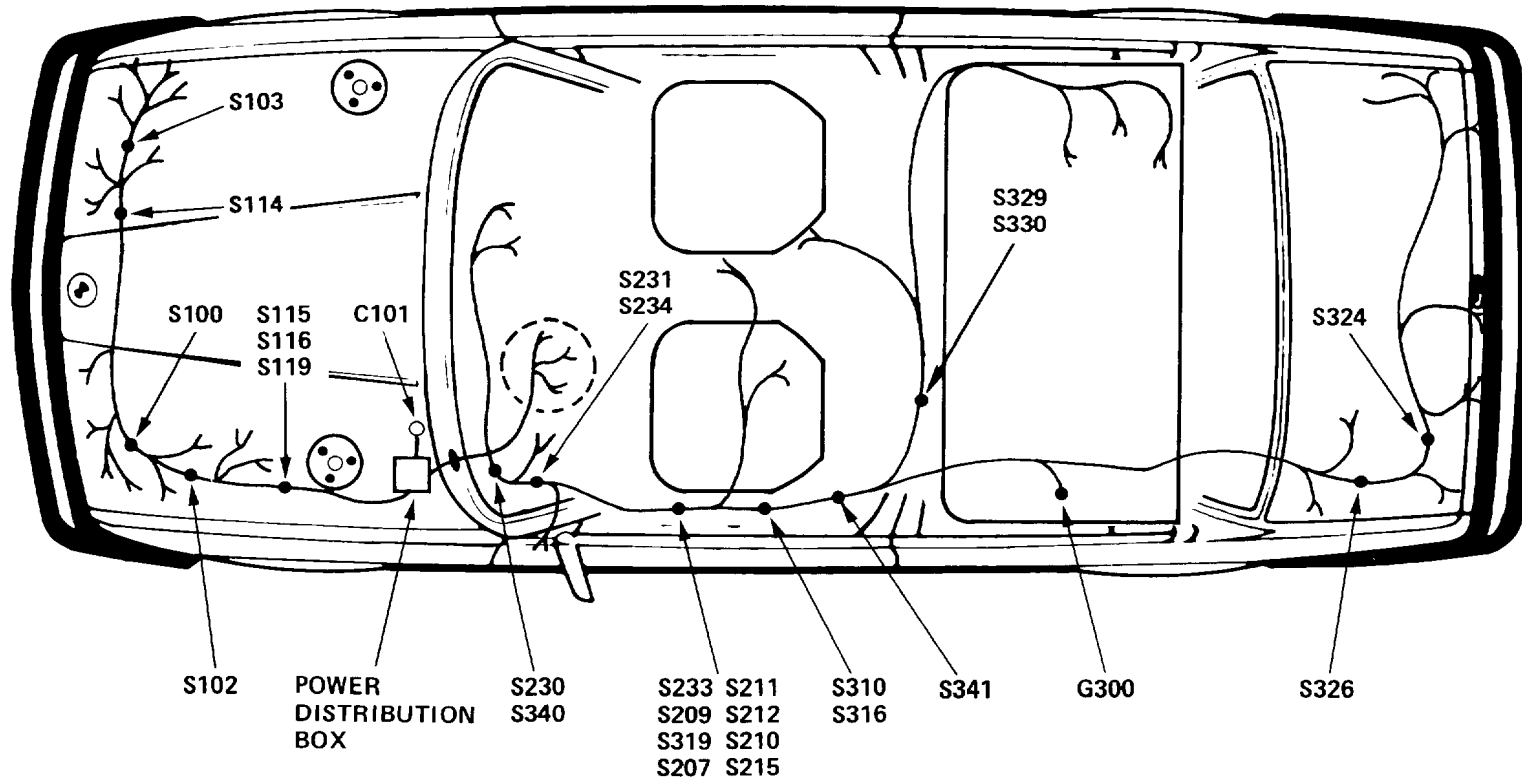
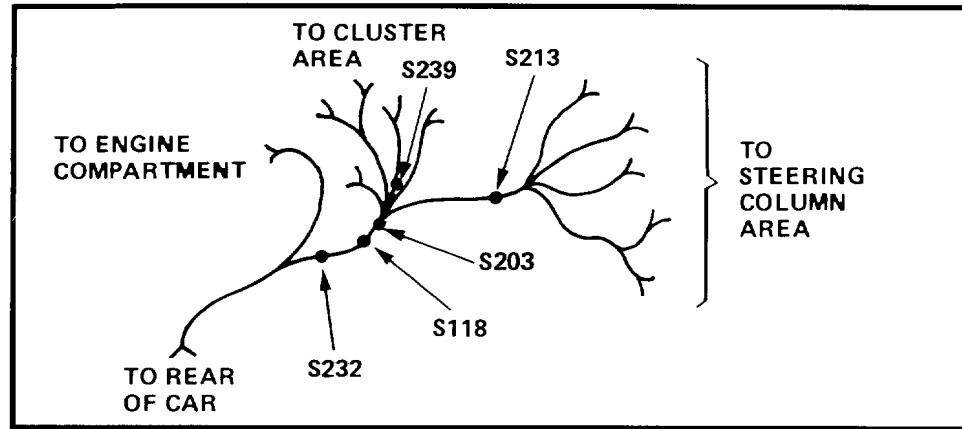

# 8000-2 SPLICE LOCATION VIEWS

## ENGINE HARNESS SPLICE LOCATIONS

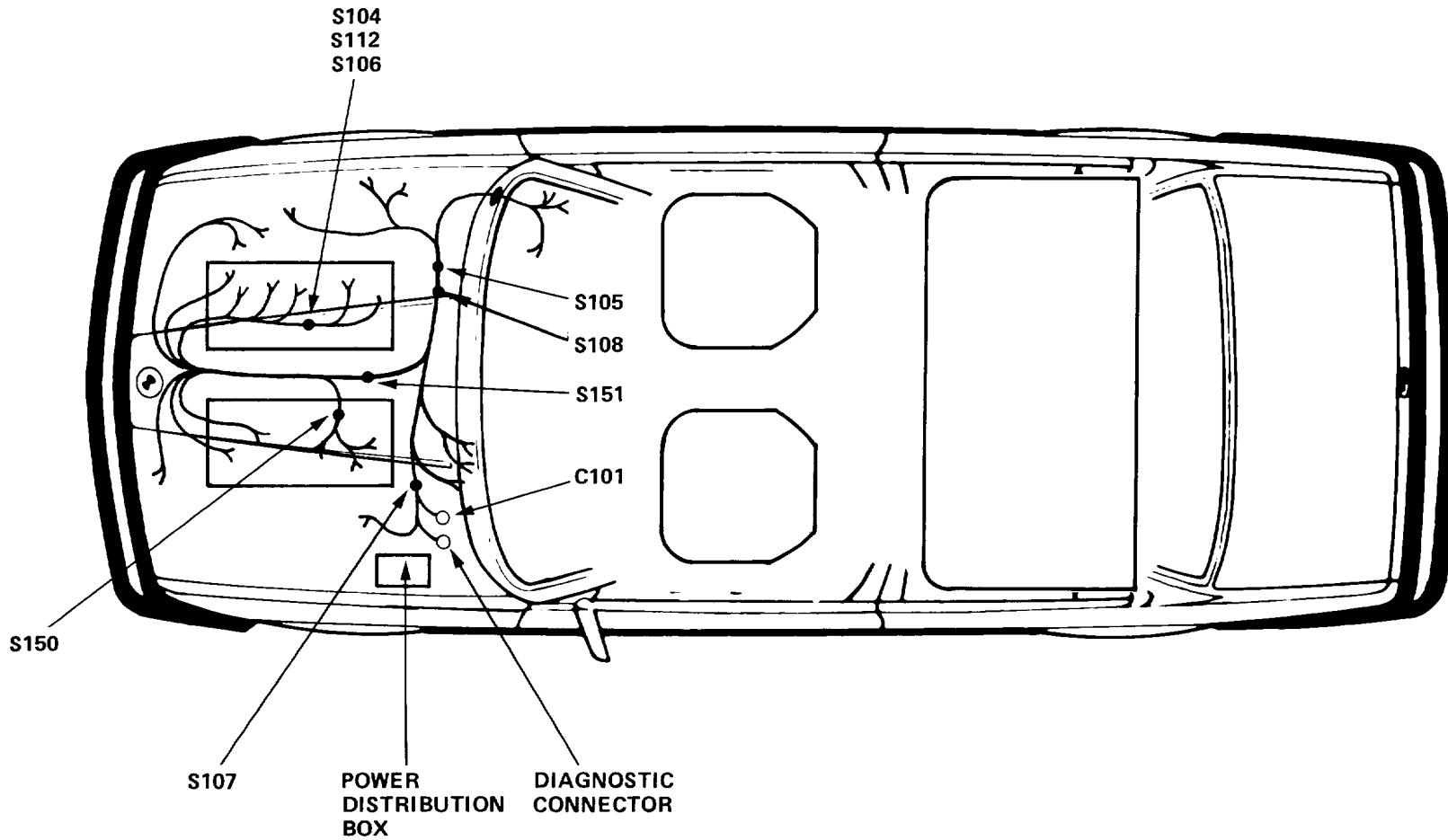

DOOR HARNESS SPLICE LOCATIONS

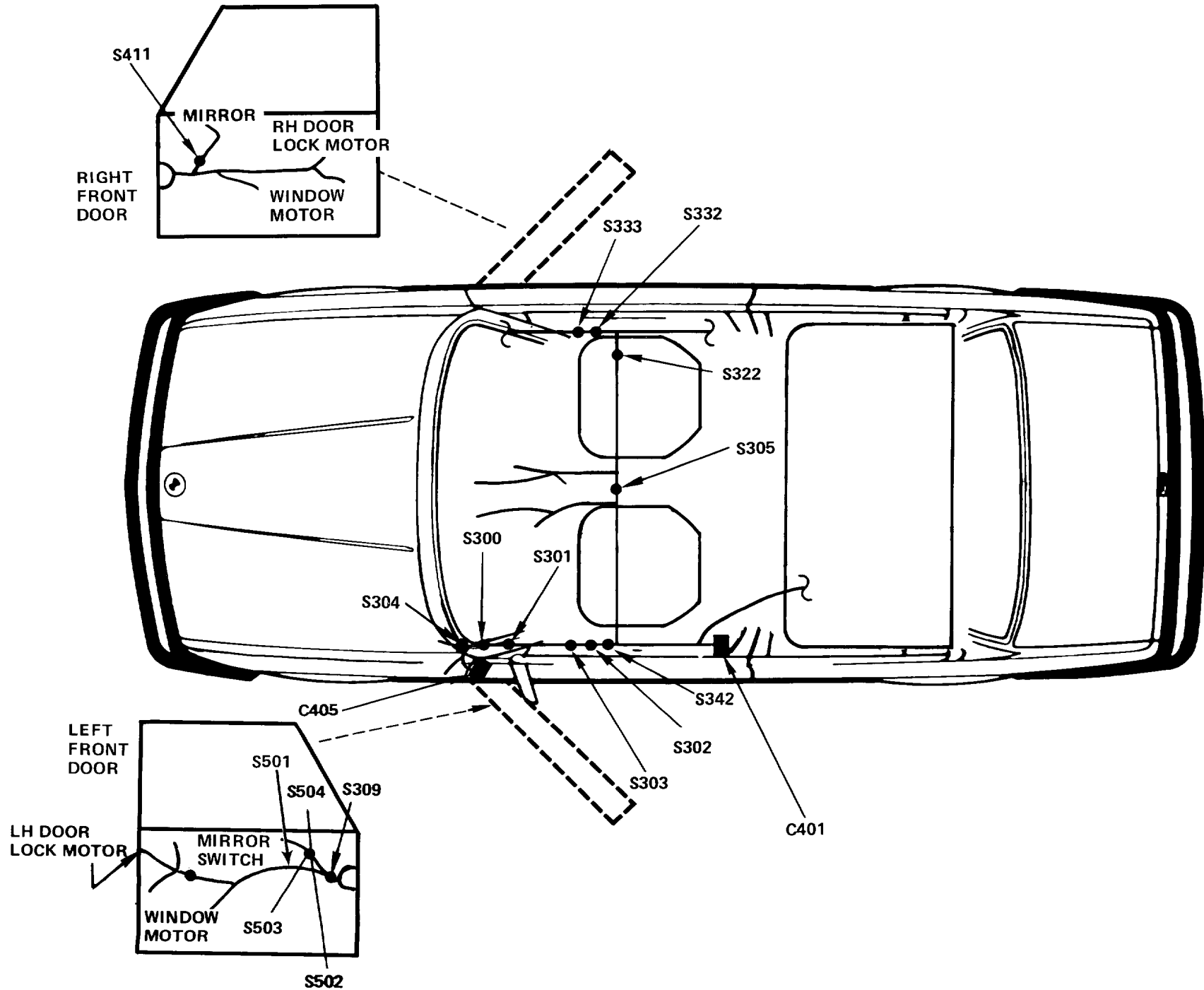

# 8000-4 SPLICE LOCATION VIEWS

## INSTRUMENT PANEL HARNESS SPLICE LOCATION

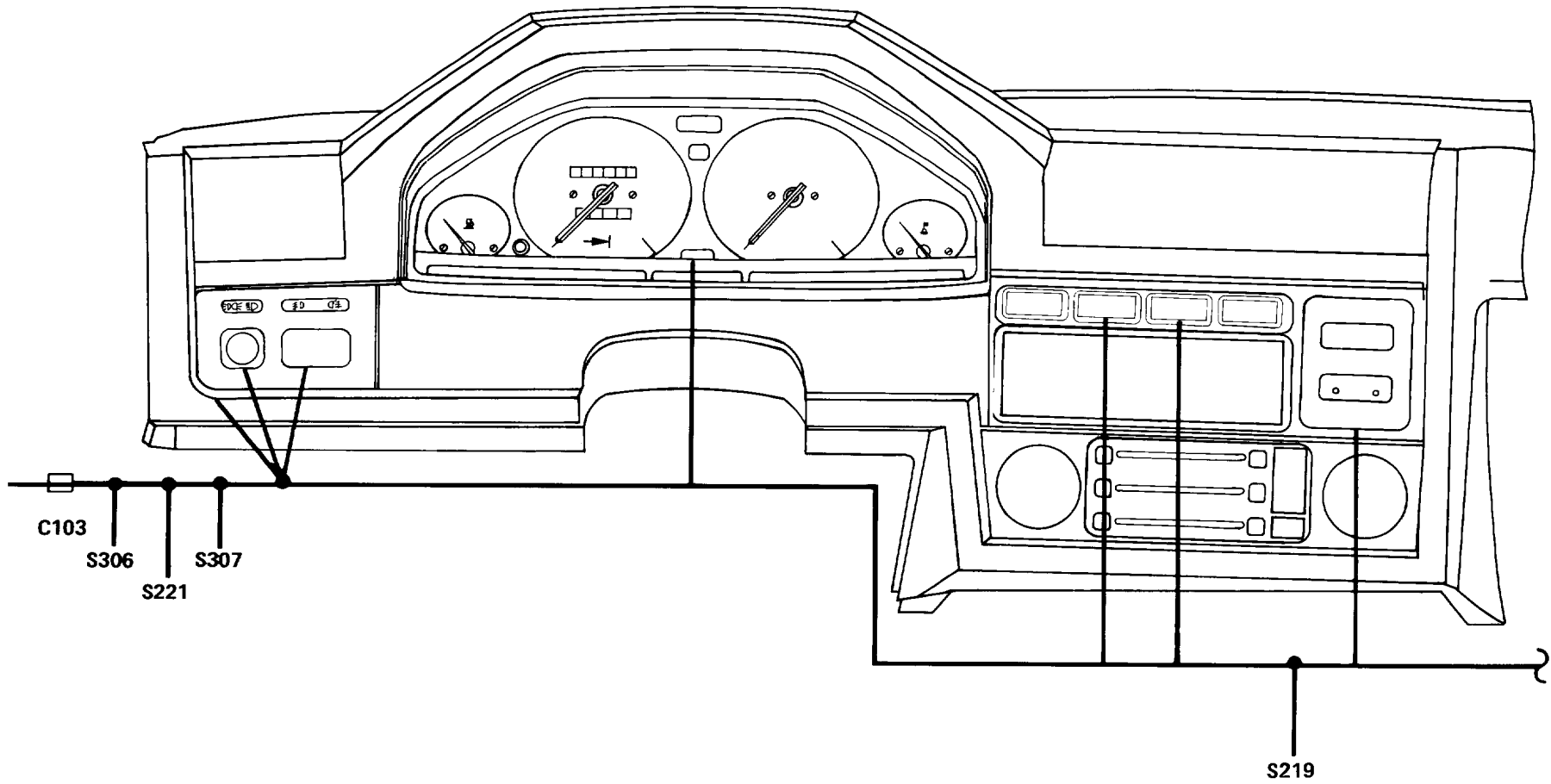

ON-BOARD COMPUTER HARNESS SPLICE LOCATIONS

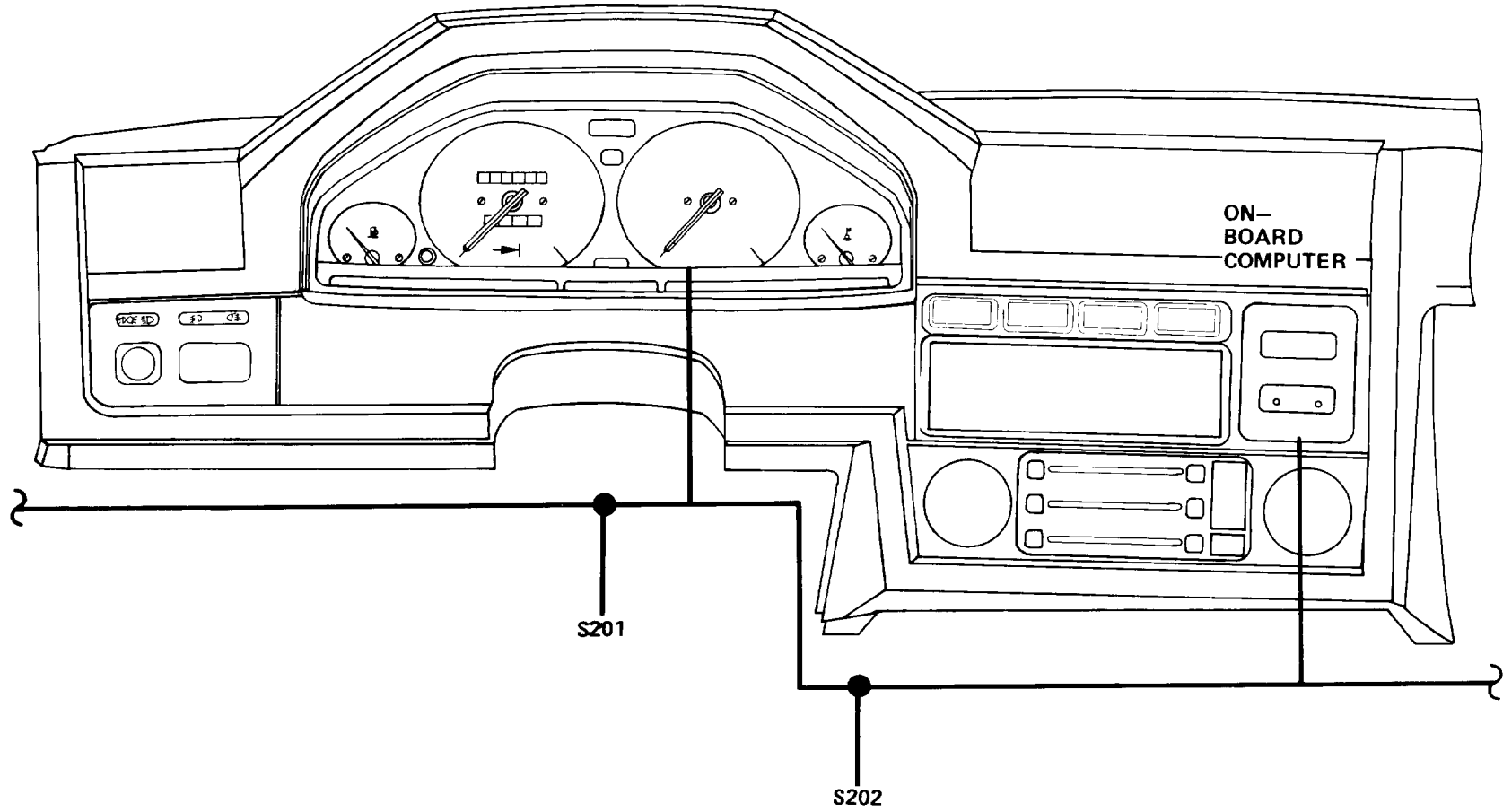



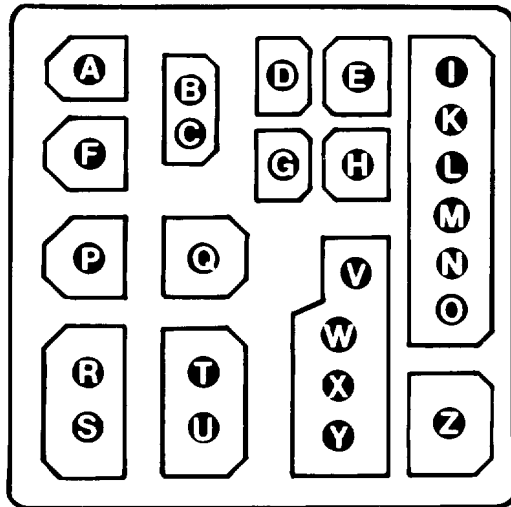

**Figure 1-C302 (Accessory Connector)**  
Front View—Under LH Side  
of Dash Ahead of Pedal Assembly

**CIRCUITS USING C302 (ACCESSORY CONNECTOR)**

TERMINAL	CIRCUIT	TERMINAL	CIRCUIT
A	Not Used	N	Not Used
B	Not Used	O	Not Used
C	Anti-Lock Braking	P	Not Used
D	Central Locking	Q	Power Windows & Sunroof
E	Not Used	R	Cruise Control
F	Not Used	S	Anti-Lock Braking
G	Anti-Lock Braking	T	Not Used
H	On-Board Computer	U	Not Used
I	Not Used	V	Radio
J	Not Used	W	Radio
K	Not Used	X	Radio
L	Not Used	Y	Radio
M	Not Used	Z	Power Antenna

# 8500-2 CONNECTOR VIEWS

B350002.04

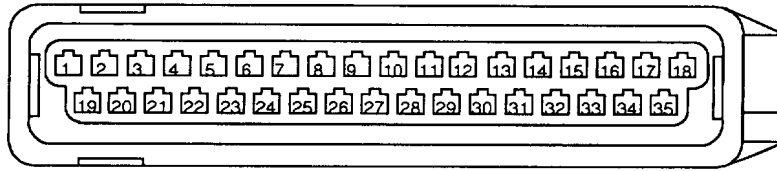

Mating Face  
ABS CONTROL UNIT

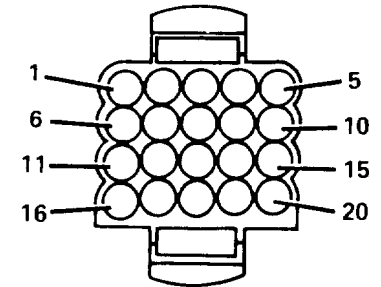

Wiring Face  
AMPLIFIER  
(SOUND SYSTEM)

B120014

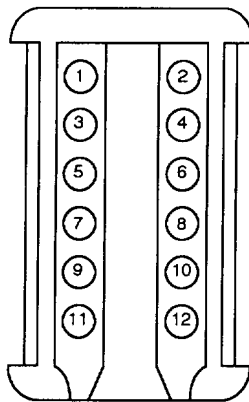

Wiring Face  
ABS HYDRAULIC UNIT

B090001.14

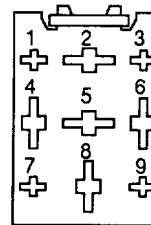

Mating Face  
ABS NEUTRAL  
INPUT RELAY

B080012

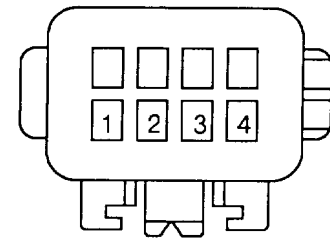

Wiring Face  
AUXILIARY FUSE

B050010.00

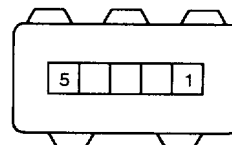

Mating Face  
AIR FLOW METER

B030015.03

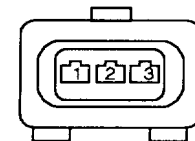

Wiring Face  
BAROMETRIC PRESSURE  
SENSOR

B260002.01

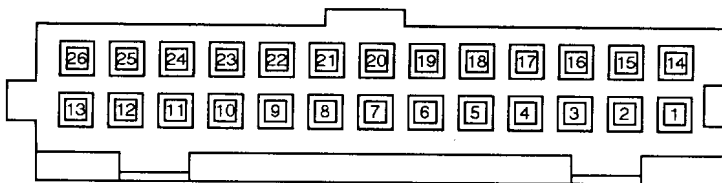

Mating Face  
ACTIVE CHECK CONTROL





Wiring Face  
CHIME MODULE (C1)

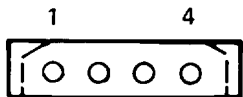

Wiring Face  
BLOWER RESISTORS

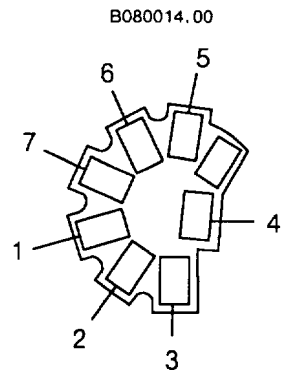

Wiring Face  
BLOWER SPEED CONTROL

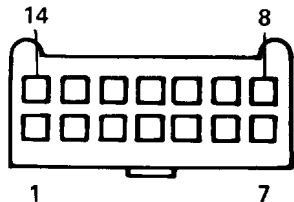

Wiring Face  
CENTRAL LOCKING CONTROL UNIT

B260002.03

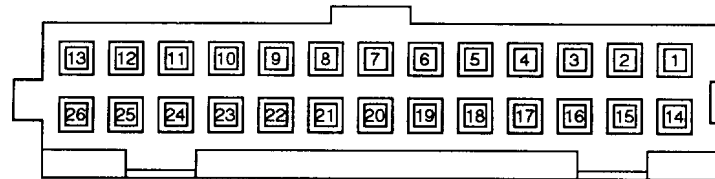

Wiring Face  
CRUISE CONTROL UNIT

B040013

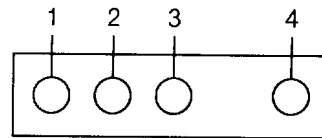

Wiring Face  
CHIME MODULE (C2)

B030015.05

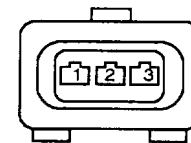

Mating Face  
CYLINDER IDENTIFICATION SENSOR

B080013.00

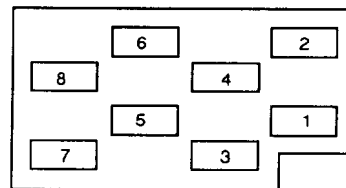

Wiring Face  
CONTROL SWITCHES

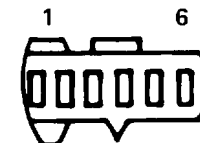

Wiring Face  
DOOR LOCK MOTOR

# 8500-4 CONNECTOR VIEWS

B030019.00

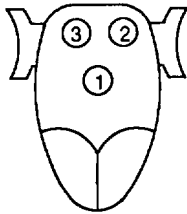

Wiring Face

DUAL TEMPERATURE SWITCH

B030015.04

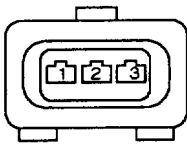

Wiring Face

ENGINE SPEED SENSOR

B090001.04

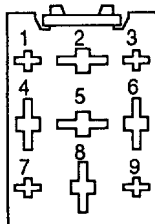

Mating Face

EVAPORATIVE  
PURGE VALVE RELAY

B060024

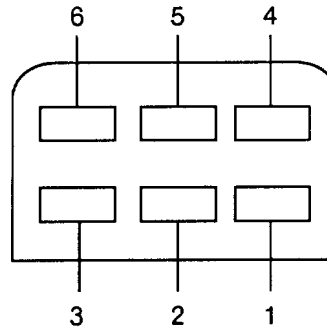

Wiring Face

EVAPORATOR TEMPERATURE  
REGULATOR

49A

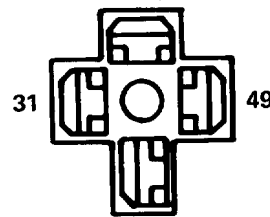

Wiring Face

FLASHER

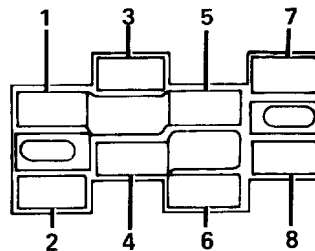

Wiring Face

FOG LIGHT SWITCH

B090001.17

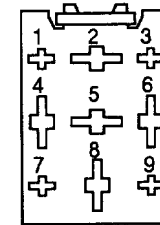

Mating Face

FRESH/RECIRCULATING AIR RELAY

B030017.00

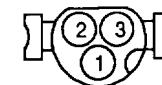

Wiring Face

FRONT TURN/PARK LIGHT

LATE PRODUCTION

for 325i/325is, 325ix

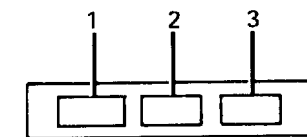

Wiring Face

FRONT TURN/PARK LIGHT

All 325ic, M3  
EARLY PRODUCTION  
for 325i/325is, 325ix

B030020.00

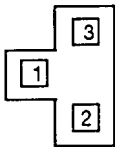

Wiring Face

INSTRUMENT CLUSTER (C6)

B090001.06

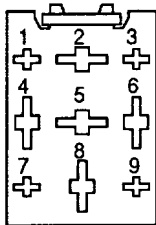

Mating Face

MAIN RELAY

2 6

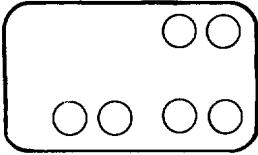

3 4 5 1

Mating Face

MIRROR CONTROL SWITCH

B090001.16

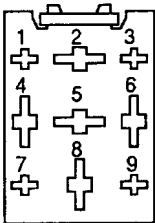

Mating Face

INTERIOR LIGHT TIMER CONTROL

B550001.02

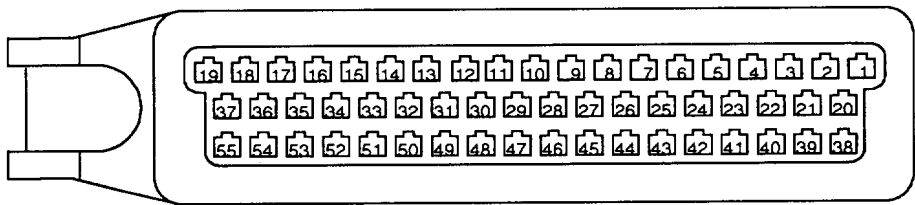

Mating Face

MOTRONIC CONTROL UNIT

ALL EXCEPT M3

B120006.00

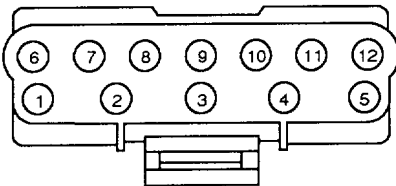

Wiring face

LIGHT SWITCH

B350002

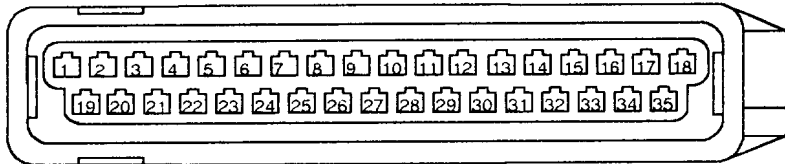

Mating Face

MOTRONIC CONTROL UNIT

(M3)

# 8500-6 CONNECTOR VIEWS

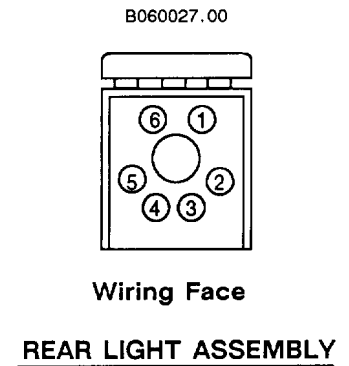
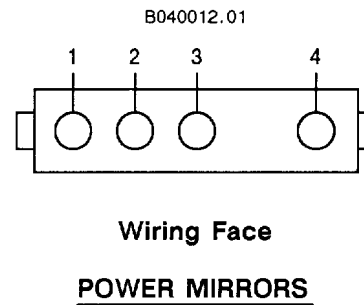
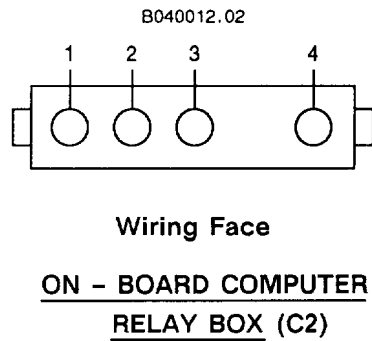
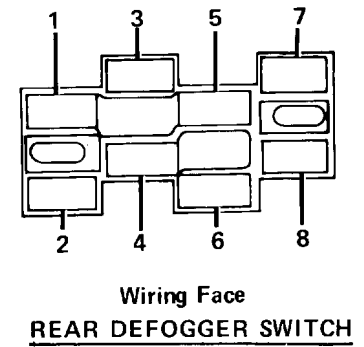
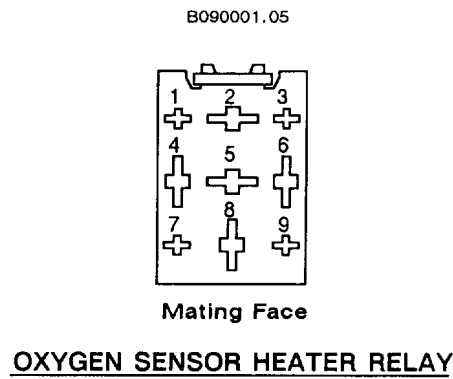
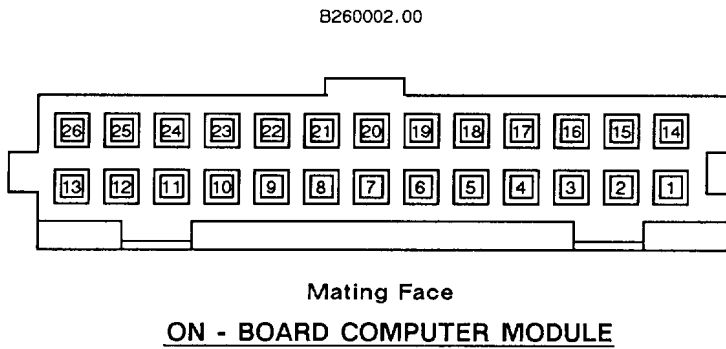
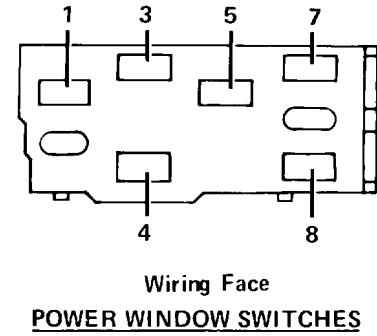
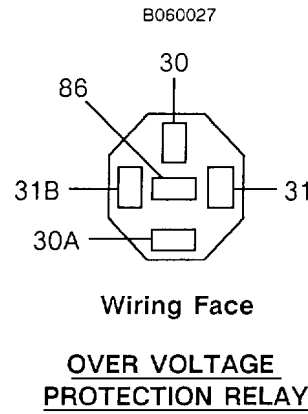
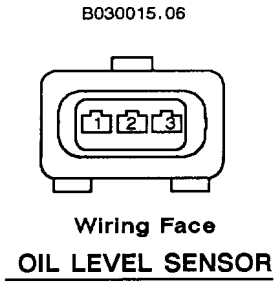

B060033.00

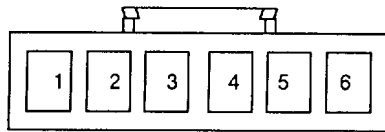

Wiring Face

REAR LIGHT ASSEMBLY

B0400002.03

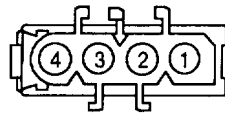

Mating Face

REAR WINDOW  
BLOWER

B090001.08

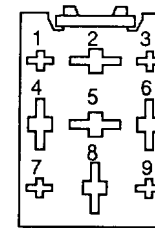

Mating Face

START RELAY

B080015.01

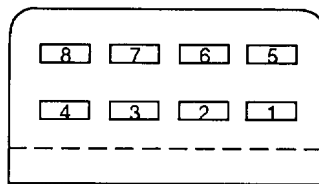

Wiring Face

REAR LIGHTS CHECK RELAY (C1)

B090001.14

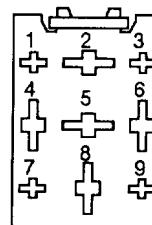

Mating Face

REAR WINDOW BLOWER RELAY

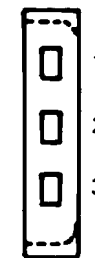

Wiring Face

SUNROOF MOTOR (C1)

B060028 .01

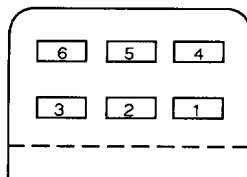

Wiring Face

REAR LIGHTS CHECK RELAY (C2)

B090001.05

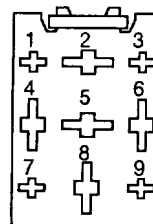

Mating Face

SEATBELT WARNING TIMER

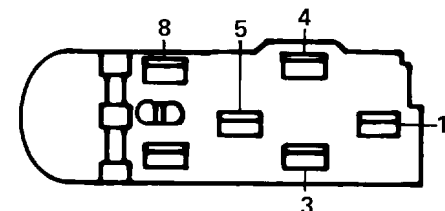

Wiring Face

SUNROOF SWITCH

8500-8 CONNECTOR VIEWS

B030015.07

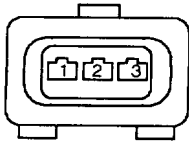

Wiring Face  
THROTTLE SWITCH

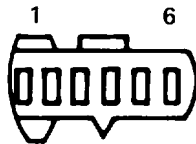

Wiring Face  
TRUNK LID LOCK MOTOR

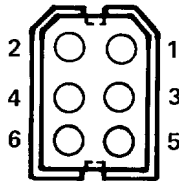

Wiring Face  
WIPER MOTOR

B200002.00

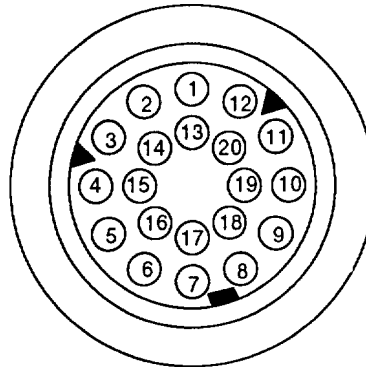

Wiring Face  
C101

B300001.00

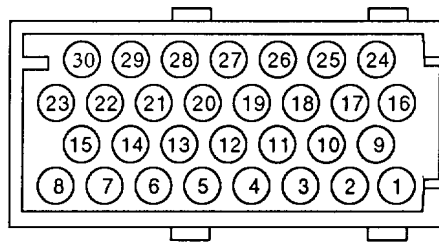

Wiring Face  
C103

B030004.02

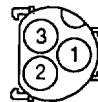

Mating Face  
C110  
C113



Wiring Face  
C114

B040002.00

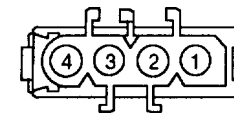

Wiring Face  
C107  
C131  
C136

B040006.01

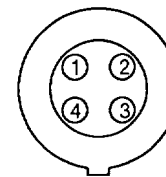

Wiring Face  
C140

B030015.06

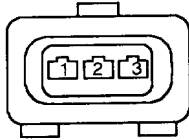

Wiring Face

C152, C153, C154

B070002.00

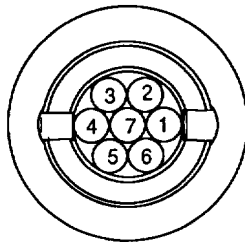

Wiring Face

C191

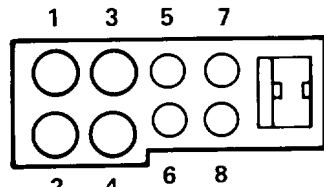

Wiring Face

C200

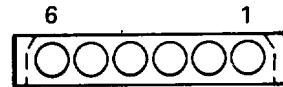

Wiring Face

C201

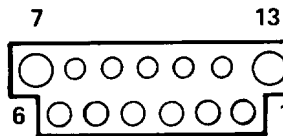

Wiring Face

C202

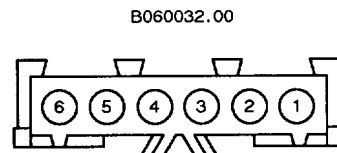

Wiring Face

C203

B120004.00

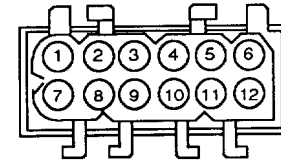

Wiring Face

C204

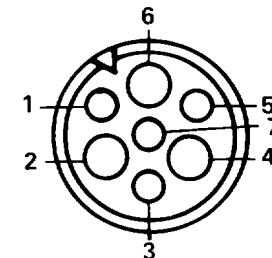

Wiring Face

C209

B070004.00

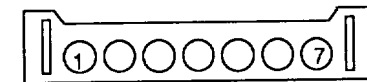

Wiring Face

C210

8500-10 CONNECTOR VIEWS

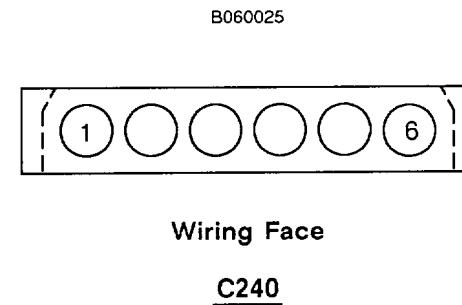
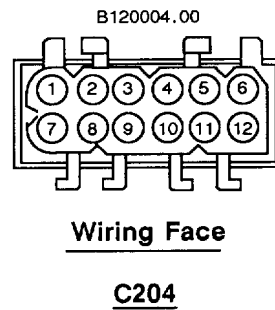
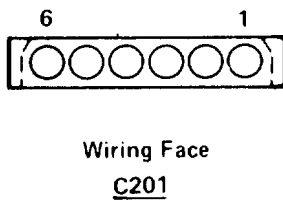
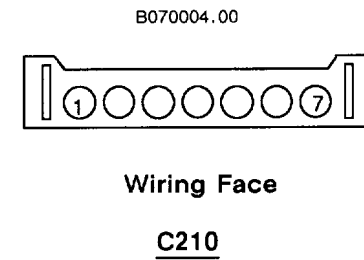
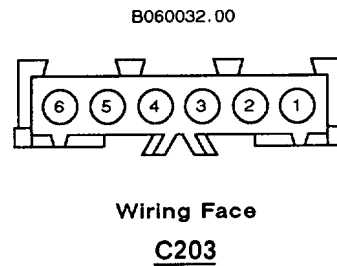
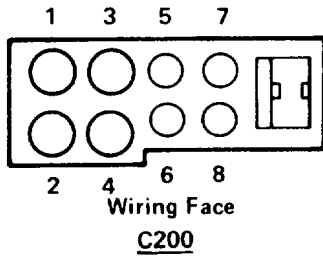
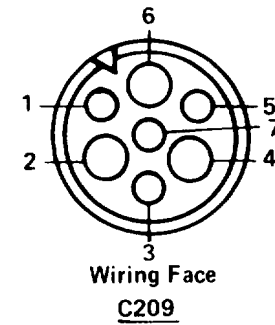
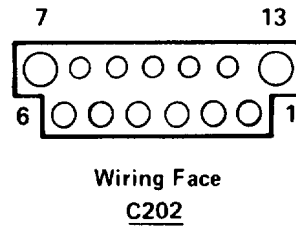
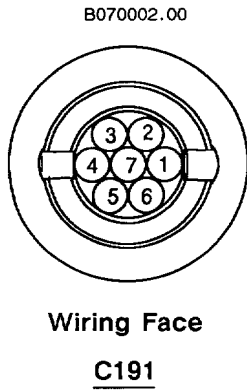



B060025



Wiring Face

C240

B060003.03

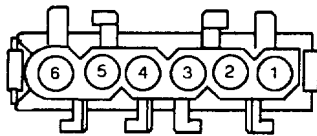

Mating Face

C242

B080002.00

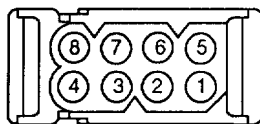

Mating Face

C243

1 2 3



Wiring Face

C303

C304

6

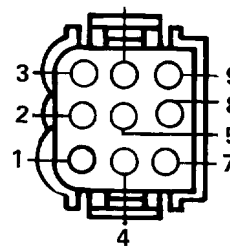

Wiring Face

C306

B050011.00

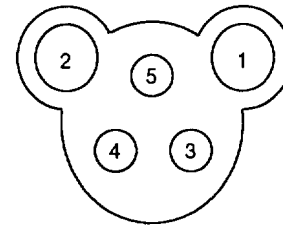

Wiring Face

C413

1 2 3 4



Wiring Face

C421

C422

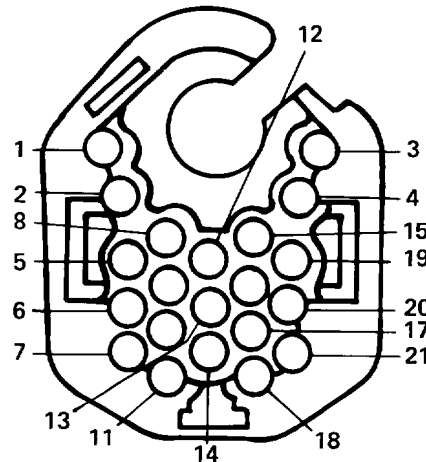

Wiring Face

C404

C405

3

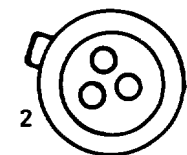

Wiring Face

C503

## 9000-0 COMPONENT LOCATION CHART

<b>COMPONENTS</b>		<b>Page-Figure</b>
A/C In-Line Fuse . . . . .	LH rear side of evaporator housing . . . . .	7000- 7-2
ABS Electronic Control Unit . . . . .	Behind LH side of dash, above hood release . . . . .	7000- 5-4
ABS Hydraulic Unit . . . . .	LH front corner of engine compartment . . . . .	7000- 1-1
Active Check Control Unit . . . . .	Above rear view mirror . . . . .	7000- 8-4
Air Flow Meter . . . . .	LH front of engine compartment, behind air cleaner . . . . .	7000- 0-6
Alternator . . . . .	Top LH front of engine compartment . . . . .	7000- 2-1
Amplifier . . . . .	LH side of trunk, above LH wheel well . . . . .	7000-10-4
Auto-Charging Flashlight . . . . .	Inside LH side of glove box . . . . .	7000- 9-1
Auxiliary Fan. . . . .	In front of radiator . . . . .	7000- 2-5
Auxiliary Fan Normal Speed Blower Resistor . . . . .	In front of radiator, RH side of auxiliary fan. . . . .	7000- 2-5
Auxiliary Fuel Pump . . . . .	Beneath RH side of rear seat . . . . .	7000-10-1
Auxiliary Fuse . . . . .	LH rear of engine compartment, above brake fluid reservoir . . . . .	7000- 0-1
Back Up Light Switch. . . . .	Top RH side of transmission. . . . .	7000- 4-5
Barometric Pressure Sensor . . . . .	LH side of engine compartment, on wheel well . . . . .	7000- 0-6
Battery . . . . .	In RH rear corner of trunk . . . . .	7000-10-6
Battery Junction Block . . . . .	RH rear of engine compartment, on RH bulkhead. . . . .	7000- 4-4
Blower Motor . . . . .	Inside fresh air intake cowl. . . . .	7000- 0-4
Blower Resistors . . . . .	Inside cowl, inside blower housing	
Board Computer Horn . . . . .	Behind LH front corner of bumper	
Brake Fluid Level Switch. . . . .	LH side of engine compartment, on brake fluid reservoir . . . . .	7000- 0-1
Brake Switch . . . . .	Behind LH side of dash, on brake pedal support. . . . .	7000- 6-1
Brake Wear Sensors. . . . .	On LH front and RH rear brake calipers . . . . .	7000- 2-3
Central Locking Control Unit . . . . .	Inside LH kick panel, below LH front speaker . . . . .	7000- 6-3
Chime Module. . . . .	Mounted on LH dash hush panel . . . . .	7000- 5-4
Clutch Switch. . . . .	Behind LH side of dash, on clutch pedal support . . . . .	7000- 6-1
Combination Switch . . . . .	Upper LH side of steering column . . . . .	7000- 7-5
Compressor Clutch . . . . .	Lower RH front of engine. . . . .	7000- 3-3
Compressor Clutch Diode . . . . .	Lower RH front of engine, on A/C compressor . . . . .	7000- 3-3
Coolant Level Switch . . . . .	Rear of RH front wheel well, in coolant reservoir . . . . .	7000- 3-6
Coolant Temperature Sender. . . . .	Front RH side of engine, on coolant manifold . . . . .	7000- 4-2
Coolant Temperature Sensor . . . . .	Front RH side of engine, on coolant manifold . . . . .	7000- 4-2
Coolant Temperature Switch. . . . .	Lower front RH corner of engine compartment . . . . .	7000- 4-1
Cruise Control Actuator . . . . .	LH front of engine compartment . . . . .	7000- 1-3
Cruise Control Unit . . . . .	Behind RH side of dash, above glove box . . . . .	7000- 8-6
Cylinder Identification Sensor . . . . .	Lower LH rear of engine, on transmission bell housing . . . . .	7000- 2-2
Diagnostic Connector. . . . .	LH side of bulkhead, by power distribution box . . . . .	7000- 0-3
Door Lock Motors . . . . .	Rear part of each door. . . . .	7000- 4-6

<b>COMPONENTS</b>	<b>Page-Figure</b>
Dual Temperature Switch . . . . .	Lower RH front corner of engine compartment . . . . . 7000- 4-1
Engine Speed Sensor . . . . .	Lower LH rear of engine, on transmission bell housing . . . . . 7000- 2-2
Evaporative Purge Valve . . . . .	LH side of engine compartment, on wheel well . . . . . 7000- 0-6
Evaporative Purge Valve Relay . . . . .	RH side of bulkhead, behind cover . . . . . 7000- 4-4
Evaporator Temperature Regulator . . . . .	On LH side of evaporator housing . . . . . 7000- 7-1
Evaporator Temperature Sensor . . . . .	On LH side of evaporator housing . . . . . 7000- 7-1
Flasher . . . . .	Upper part of steering column . . . . . 7000- 7-5
Fresh/Recirculating Air Flap Door Motors . . . . .	Behind A/C face plate, on either side of evaporator housing . . . . . 7000- 7-4
Fresh/Recirculating Air Relays . . . . .	Behind A/C face plate . . . . . 7000- 7-3
Fuel Injectors . . . . .	Top of engine, at each intake port . . . . . 7000- 1-6
Fuel Tank Sender . . . . .	Below RH side of rear seat, on top of fuel tank . . . . . 7000-10-1
Fusible Link A . . . . .	RH rear of trunk, on battery . . . . . 7000-10-6
Gas Filler Lock Motor . . . . .	RH side of trunk, behind RH wheel well . . . . . 7000-10-6
Glove Box Light Switch . . . . .	Behind RH side of dash, above glove box . . . . . 7000- 8-6
Hazard Switch . . . . .	In center of dash, above digital radio . . . . . 7000- 7-6
High Pressure Cut-Out Switch . . . . .	On receiver dryer, behind RH headlight . . . . . 7000- 3-2
Horn Brush/Slip Ring . . . . .	In upper part of steering column . . . . . 7000- 7-5
Horns . . . . .	Near fog lights, behind splash guard
Hot Water Cut-Off Switch . . . . .	Behind center of dash, near rotary temperature control . . . . . 7000- 7-3
Idle Speed Actuator . . . . .	Top center of engine . . . . . 7000- 1-5
Ignition Coil . . . . .	On RH front wheel well, forward of shock tower . . . . . 7000- 3-6
Ignition Key Switch . . . . .	Part of ignition switch, in upper part of steering column
Ignition Switch . . . . .	Top RH side of steering column . . . . . 7000- 7-5
Interior Light Timer Control . . . . .	Inside LH kick panel, below LH front speaker . . . . . 7000- 6-3
LH Jet Heater . . . . .	Center of engine compartment hood, on washer jet . . . . . 7000- 2-6
Lock Heater . . . . .	In top rear of LH front door . . . . . 7000- 5-2
Lock Heater Control Unit . . . . .	In top rear of LH front door . . . . . 7000- 5-3
Low Pressure Cut-Out Switch . . . . .	On receiver dryer, behind RH headlight . . . . . 7000- 3-2
Main Fuel Pump . . . . .	Under car, in front of LH rear wheel. . . . . 7000-10-2
Main Relay . . . . .	RH rear of engine compartment, on bulkhead . . . . . 7000- 4-4
Motor Relay . . . . .	In windshield header, above rear view mirror . . . . . 7000- 8-4
Motronic Control Unit . . . . .	Behind RH side of dash, above glove box . . . . . 7000- 8-6
Oil Pressure Switch . . . . .	Lower LH front of engine . . . . . 7000- 1-2
Oil Temperature Sensor . . . . .	Lower LH front of engine . . . . . 7000- 1-2
On-Board Computer Module . . . . .	In center of dash, on RH side of digital radio . . . . . 7000- 8-1

## 9000-2 COMPONENT LOCATION CHART

<b>COMPONENTS</b>		<b>Page-Figure</b>
On-Board Computer Relay Box . . .	Behind LH side of dash, near ABS electronic control unit . . . . .	7000- 5-6
Outside Temperature Sensor . . .	Behind splash guard, near LH fog light . . . . .	7000- 1-4
Over Voltage Protection Relay . . .	Behind LH side of dash, near ABS electronic control unit . . . . .	7000- 5-5
Oxygen Sensor . . . . .	Lower RH rear of engine compartment, on exhaust manifold . . . . .	7000- 4-3
Oxygen Sensor/Fuel Pump Relay	RH rear of engine compartment, on bulkhead . . . . .	7000- 4-4
Park Brake Switch . . . . .	At base of parking brake . . . . .	7000- 8-3
Power Distribution Box . . . . .	LH rear corner of engine compartment . . . . .	7000- 0-1
Power Window Circuit Breaker . . .	On center console, near gear shift lever . . . . .	7000- 8-2
Pulse Wheels . . . . .	On respective wheel, in brake housing	
Rear Lights Check Relay . . . . .	LH side of trunk, above LH wheel well . . . . .	7000-10-4
RH Front Door Micro Switch . . . . .	In top rear of RH front door . . . . .	7000- 5-2
RH Jet Heater . . . . .	Center of engine compartment hood, on washer jet . . . . .	7000- 2-6
Seatbelt Switch . . . . .	In driver's seatbelt buckle assembly	
Seatbelt Warning Timer . . . . .	Behind LH side of dash, on electrical bracket . . . . .	7000- 6-6
Speed Detectors . . . . .	On wheels, in brake housing . . . . .	7000- 2-4
Speedometer Sender . . . . .	On rear of differential . . . . .	7000-10-3
SRS Connector (C240) . . . . .	Behind LH side of dash, RH side of accessory connector . . . . .	7000- 5-6
Starter . . . . .	Lower LH rear of engine	
Sunroof Motor . . . . .	In windshield header, above rear view mirror . . . . .	7000- 8-4
TDC Sensor . . . . .	Lower LH rear of engine . . . . .	7000- 0-5
Throttle Switch . . . . .	Top front center of engine . . . . .	7000- 1-5
Trunk Lid Lock Motor . . . . .	On trunk lock center support . . . . .	7000-10-5
Trunk Light Switch . . . . .	Top center of trunk lid . . . . .	7000-11-1
Unlock Inhibit Switch . . . . .	Top rear of LH front door . . . . .	7000- 5-2
Washer Fluid Level Switch . . . . .	Behind RH headlight, in washer fluid reservoir . . . . .	7000- 3-2
Washer Pump . . . . .	Ahead of RH front wheel well, on washer fluid reservoir . . . . .	7000- 3-4
Water Shut-Off Solenoid . . . . .	LH side of evaporator housing . . . . .	7000- 7-2
Window Motors . . . . .	Forward part of each door . . . . .	7000- 5-1
Wiper Motor . . . . .	Inside LH side of fresh air intake cowl . . . . .	7000- 0-4
<b>CONNECTORS</b>		
150° Compressor Oil Temperature Switch . . . . .	Bottom RH front of engine compartment, on A/C compressor . . . . .	7000- 3-5
C101 (20 pins) . . . . .	Next to power distribution box, mounted on engine dash . . . . .	7000- 0-3
C103 (29 pins) . . . . .	Behind LH side of dash, on body electrical bracket . . . . .	7000- 5-6

**CONNECTORS**

		Page-Figure
C104 (2 pins)	Behind LH side of dash, near accessory connector . .	7000- 5-6
C106 (2 pins)	RH front corner of engine compartment . . . . .	7000- 3-4
C107 (4 pins)	Behind RH side of dash, above glove box . . . . .	7000- 8-5
C110 (2 pins)	RH front of engine compartment. . . . .	7000- 3-2
C113 (3 pins)	LH front of engine compartment, behind headlight. .	7000- 1-1
C114 (8 pins)	LH rear corner of engine compartment, on power distribution box . . . . .	7000- 0-2
C115 (2 pins)	LH rear corner of engine compartment, on power distribution box . . . . .	7000- 0-2
C126 (2 pins)	LH front of engine compartment, behind LH headlight. . . . .	7000- 1-1
C127 (2 pins)	RH front of engine compartment, behind RH headlight. . . . .	7000- 3-2
C128 (2 pins)	RH front of engine compartment, behind RH headlight. . . . .	7000- 3-2
C129 (2 pins)	Behind LH front side marker light . . . . .	7000- 1-1
C130	Behind RH side of dash, in harness, above glove box	
C140 (3 pins)	RH rear of engine compartment, under tray . . . . .	7000- 3-6
C142 (1 pin)	Behind LH side of dash, near steering column . . . . .	7000- 6-1
C143 (1 pin)	Behind LH side of dash, near accessory connector. .	7000- 6-2
C150 (2 pins)	Front of LH front wheel well, on bracket . . . . .	7000- 0-6
C151 (2 pins)	Front of RH front wheel well . . . . .	7000- 3-5
C152 (3 pins)	Center of bulkhead, above rear of engine . . . . .	7000- 0-3
C153 (3 pins)	Center of bulkhead, above rear of engine . . . . .	7000- 0-3
C154 (3 pins)	Center of bulkhead, above rear of engine . . . . .	7000- 0-3
C200 (10 pins)	Behind LH side of dash, on steering column . . . . .	7000- 6-1
C201 (6 pins)	Behind LH side of dash, on steering column . . . . .	7000- 6-1
C202 (13 pins)	Behind LH side of dash, on steering column . . . . .	7000- 6-1
C203 (8 pins)	Under LH side of dash, below accessory connector .	7000- 6-2
C204 (12 pins)	Behind LH side of dash, RH side of steering column .	7000- 7-4
C205 (2 pins)	Inside LH kick panel . . . . .	7000- 6-3
C209 (7 pins)	Behind LH side of dash, near brake pedal support . .	7000- 6-2
C210 (7 pins)	Behind LH side of dash, on steering column . . . . .	7000- 6-1
C213 (1 pin)	Behind center of dash, on digital radio . . . . .	7000- 7-6
C214 (1 pin)	Behind center of dash, on digital radio . . . . .	7000- 7-6
C215 (2 pins)	Behind center of dash, behind digital radio . . . . .	7000- 8-1
C216 (2 pins)	Behind center of dash, on digital radio . . . . .	7000- 7-6
C217 (1 pin)	Behind LH side of dash, near accessory connector. .	7000- 6-2
C233 (1 pin)	Behind center of dash, near digital radio. . . . .	7000- 8-1
C242 (2 pins)	Behind center of dash, on digital radio . . . . .	7000- 7-6
C243 (8 pins)	Behind center of dash, near digital radio. . . . .	7000- 8-1
C260 (2 pins)	Behind LH side of dash, near accessory connector. .	7000- 6-2

## 9000-4 COMPONENT LOCATION CHART

---

### CONNECTORS

		Page-Figure
C301 (2 pins)	Below center console, near gear shift lever . . . . .	7000- 8-2
C302 (25 pins) Accessory Connector	Behind LH side of dash, on body electrical bracket. . . . .	7000- 5-6
C303 (3 pins)	At base of RH "B" pillar . . . . .	7000- 9-6
C304 (3 pins)	At base of LH "B" pillar . . . . .	7000- 9-4
C305 (1 pin)	Behind LH side of dash, near accessory connector. . . . .	7000- 5-6
C352 (2 pins)	Behind LH side of rear seat. . . . .	7000- 9-5
C360 (2 pins)	Behind RH side of rear seat . . . . .	7000-10-1
C404 (21 pins)	Above RH front door jamb switch . . . . .	7000- 9-3
C405 (21 pins)	Above LH front door jamb switch . . . . .	7000- 6-5
C406 (1 pin)	Below RH front speaker. . . . .	7000- 9-2
C407 (1 pin)	Below LH front speaker . . . . .	7000- 6-4
C500 (1 pin)	Behind LH side of dash, near steering column . . . . .	7000- 6-1
C503 (3 pins)	In lower rear of LH front door . . . . .	7000- 4-6
C510 (1 pin)	Inside LH kick panel, above LH front speaker . . . . .	7000- 6-3
C560 (1 pin)	In top rear of LH front door . . . . .	7000- 5-2

### GROUNDS

G100.	RH rear corner of trunk, behind battery . . . . .	7000-10-6
G103.	Behind RH side of dash, near motronic control unit . . . . .	7000- 8-5
G104.	On inner fender, behind LH headlight . . . . .	7000- 1-3
G106.	RH front corner of engine compartment . . . . .	7000- 3-1
G200.	Behind LH side of dash, above clutch pedal . . . . .	7000- 6-1
G201 (Steering Column Ground)	Upper LH side of steering column . . . . .	7000- 7-5
G300.	Behind LH side of rear seat. . . . .	7000- 9-5
G600.	In windshield header	

---