

1986

BMW 524TD

Electrical

Troubleshooting

Manual

BMW of North America, Inc.
Montvale, New Jersey

FOREWORD

In the interests of continuing technical development work we reserve the right to modify designs and equipment.

Printed in USA

©Copyright BMW of North America, Inc.

Not to be reproduced wholly or in part
without written permission of BMW of
North America, Inc.

PN 89 89 1 000 172

**1986
BMW 524TD
Electrical
Troubleshooting
Manual**

CONTENTS

How To Use This Manual	3
Symbols	4
Wire Size Conversion Chart	5
Systematic Troubleshooting	6
Section C: 524TD Schematic Diagrams	
524TD Index	2
Diagnostic Connector	8500-0
Power Distribution Box	0670-0
Fuse Data	0670-1
Component Location Chart	9000-0
Component Location Views	7000-0
Splice Location Views	8000-0

Index — Alphabetical Listing of Electrical Circuits

	PAGE		PAGE		PAGE
Active Check Control	6216- 0	Horn	6100- 0	— Hazard Warning	6313- 0
Air Conditioning		Ignition Key Warning	6131- 0	— Headlights	6312- 1
— Blower Controls.	6413- 0	Indicators		— Heater A/C Panel	6300- 3
— Temperature Control	6411- 0	— Active Check Control Alarm. . .	6210- 1	— Interior.	6330- 0
AntiLock Brake	3450- 0	— “Brake Lights” Fault	6216- 1	— Instrument Cluster.	6300- 2
Auto-Charging Flashlight	6100- 2	— “Brake Lining” Wear	3435- 0	— License	6320- 0
Auxiliary Fan.	6454- 0	— “Brake” Warning.	6210- 2	— Rear Marker	6320- 0
Brake Lining Warning	3435- 0	— Charge.	6210- 0	— Stop Light	6325- 0
Central Locking	5126- 0	— “Coolant” Level Fault.	6216- 2	— Tail	6314- 0
Charging System	1230- 0	— “Engine Oil” Fault	6216- 2	— Transmission Range	6300- 2
Cigar Lighter	6100- 2	— Fasten Seatbelts	6216- 2	— Turn	6313- 1
Connectors		— Foglights	6210- 2	— Trunk.	6320- 0
— Accessory	8500- 1	— Fuel Filter	6216- 2	Light Switch Details	6300- 0
— Diagnostic	8500- 0	— Highbeam.	6210- 2	Multifunction Clock	6581- 0
Cruise Control.	6571- 0	— Injection.	6216- 2	Power Antenna	6500- 0
Engine Control Block Diagrams. . .	1250- 0	— Inspection	6210- 3	Power Distribution	0670- 1
Exhaust Gas Recirculation.	1360- 1	— LH Turn	6210- 2	Power Distribution Box	0670- 1
Fuel Control	1360- 1	— “License Plate” Fault	6216- 1	Power Mirrors	5116- 0
Fuel Delivery.	1360- 0	— “Low Beam” Fault.	6216- 0	Power Seats	5200- 0
Fuse Data.	0670- 1	— Low Fuel Warning	6210- 1	Power Windows	5133- 0
Fuse Details		— Oil Pressure Warning	6210- 1	Radio.	6500- 0
— Fuse 4	0670- 5	— Oil Service	6210- 3	Rear Defogger.	6100- 1
— Fuse 5	0670- 8	— “Park Brake”	6210- 1	Seatbelt Warning	6131- 0
— Fuse 6	0670- 4	— Pre-Heating	6210- 2	Service Internal Indicator	6210- 3
— Fuse 11	0670- 6	— “Rear Lights” Fault	6216- 1	Speedometer	6210- 0
— Fuse 12	0670- 7	— RH Turn	6210- 2	Splice Locations	8000- 0
— Fuse 13	0670- 5	— Start Engine	6210- 2	Start	
— Fuse 14	0670- 7	— “Washer Fluid” Fault	6216- 2	— Automatic	1240- 0
— Fuse 17	0670- 5	Lights		— Manual	1240- 1
Gauges		— Active Check Control Panel . . .	6216- 2	Sunroof	5413- 0
— Fuel.	6210- 1	— Ash Tray	6300- 3	Warnings	
— Temperature.	6210- 1	— Backup	6322- 0	— Ignition Key	6131- 0
Glow Plug Control	1220- 0	— Dash	6300- 2	— Seatbelt.	6131- 0
Ground Distribution	0670- 9	— Dome	6330- 0	Washer Jet Heaters	6160- 0
Heated Door Lock	6100- 1	— Fog	6312- 1	Wiper/Washer.	6160- 0
Heating		— Front Marker.	6314- 0		
— Blower Controls.	6413- 0	— Front Park.	6314- 0		
— Temperature Controls.	6411- 0	— Glove Box.	6100- 2		

The purpose of this manual is to show electrical schematics in a manner that makes electrical troubleshooting easier. Electrical components which work together are shown together on one schematic. The Wiper-Washer schematic, for example, shows all of the electrical components in one diagram. At the top of the page is the fuse (positive) that powers the circuit. The flow of current is shown through all wires, connectors, switches, and motors to ground (negative) at the bottom of the page.

Within the schematic, all switches and sensors are shown "at rest," as though the Ignition Switch were off. For identification, component names are underlined and placed next to or above each component. Notes are included, describing how switches and other components work.

The power distribution schematic shows the current feed through all the connections from the Battery and Alternator to each fuse and the Ignition and Light Switches. If the Power Distribution schematic is combined with any other circuit schematic, a complete picture is made of how that circuit works. The Ground Distribution schematics show how several circuits are connected to common grounds.

All wiring between components is shown exactly as it exists in the vehicle; however, the wiring is not drawn to scale. To aid in understanding electrical operation, wiring inside complicated components has been simplified. The "Solid State" label designates electronic components.

WIRE SIZE CONVERSION CHART	
METRIC (CROSSSECTIONAL AREA IN MM ²)	AWG (AMERICAN WIRE GAUGE)
.5	20
.75	18
1	16
1.5	14
2	14
2.5	12
4	10
6	8
8	8
16	4
20	4
25	2
32	2

WIRE INSULATION	
ABBREVIATIONS	COLOR
BK	BLACK
BR	BROWN
RD	RED
YL	YELLOW
GN	GREEN
BU	BLUE
VI	VIOLET
GY	GRAY
WT	WHITE
PK	PINK

4 SYMBOLS

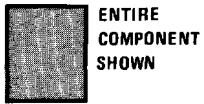

ENTIRE COMPONENT SHOWN



PART OF A COMPONENT SHOWN

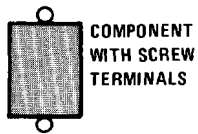

COMPONENT WITH SCREW TERMINALS



SOLID STATE (INCLUDES ONLY ELECTRONIC PARTS)

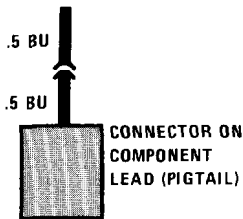

CONNECTOR ON COMPONENT LEAD (PIGTAIL)

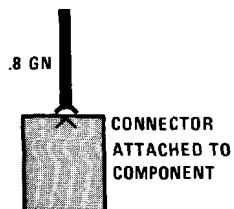

CONNECTOR ATTACHED TO COMPONENT

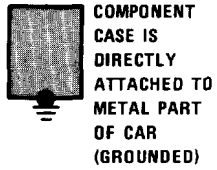

COMPONENT CASE IS DIRECTLY ATTACHED TO METAL PART OF CAR (GROUNDED)

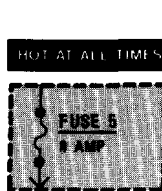

HOT AT ALL TIMES

INDICATES THAT FUSE 5 IS ALWAYS SUPPLIED WITH POWER

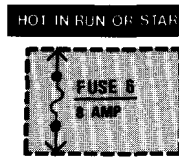

HOT IN RUN OR START

INDICATES THAT FUSE 6 IS SUPPLIED WITH POWER WITH THE IGNITION SWITCH IN THE RUN OR START POSITIONS

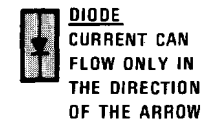
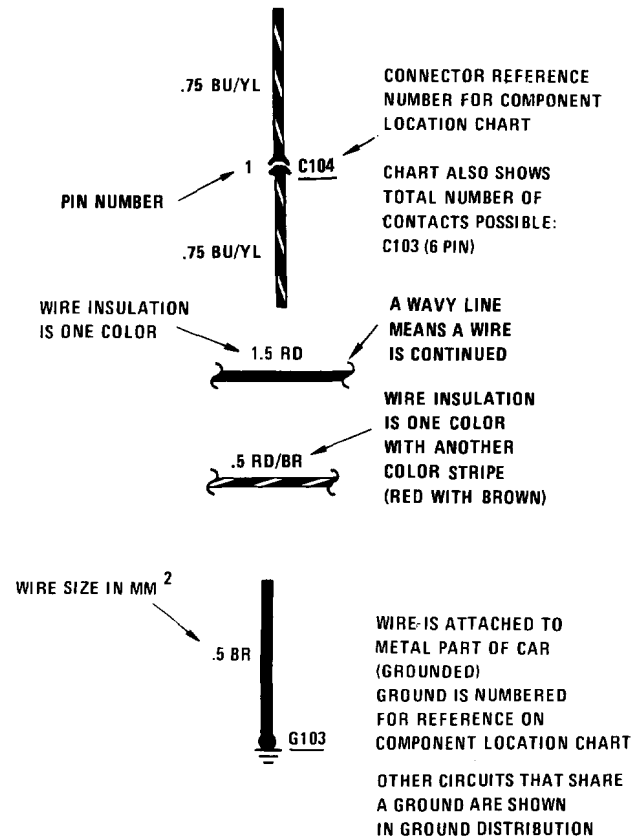
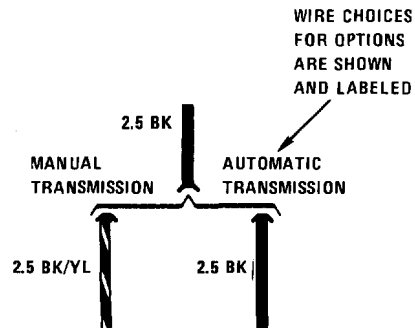

DIODE CURRENT CAN FLOW ONLY IN THE DIRECTION OF THE ARROW

CIRCUIT REFERENCE - A WIRE WHICH CONNECTS TO ANOTHER CIRCUIT



ACTIVE CHECK CONTROL



ONE POLE, TWO POSITION SWITCH

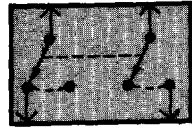

SWITCHES THAT MOVE TOGETHER
DASHED LINE SHOWS A MECHANICAL CONNECTION BETWEEN SWITCHES

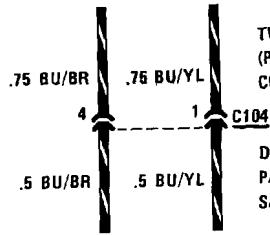

TWO CONNECTIONS (PINS) IN THE SAME CONNECTOR
DASHED LINE SHOWS PARTS OF THE SAME CONNECTOR

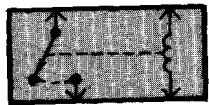

WHEN COIL IS ENERGIZED, SWITCH IS PULLED CLOSED

RELAY SHOWN WITH NO CURRENT FLOWING THROUGH COIL

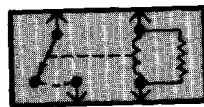

RELAY SHOWN WITH RESISTOR ACROSS COIL
RESISTOR ACROSS COIL IS FOR NOISE SUPPRESSION

RELAY SHOWN WITH RESISTOR ACROSS COIL

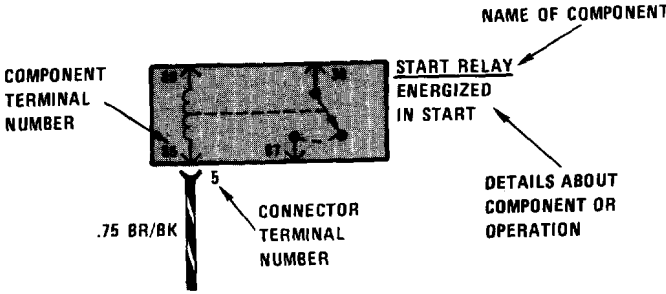

COMPONENT TERMINAL NUMBER

.75 BR/BK

CONNECTOR TERMINAL NUMBER

START RELAY ENERGIZED IN START

NAME OF COMPONENT

DETAILS ABOUT COMPONENT OR OPERATION

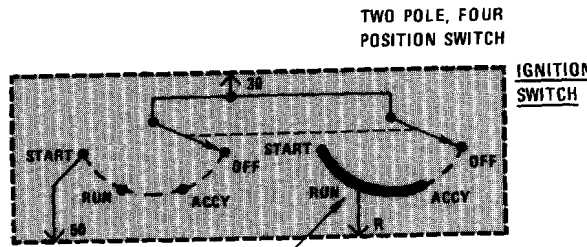

TWO POLE, FOUR POSITION SWITCH

IGNITION SWITCH

"R" IS ENERGIZED IN ACCY, RUN OR START



LOW BEAM RELAY

2.5 YL

TO POWER DISTRIBUTION BOX, PAGE 1

CURRENT PATH IS CONTINUED AS LABELED. THE ARROW SHOWS DIRECTION OF CURRENT FLOW AND IS REPEATED WHERE CURRENT PATH CONTINUES.

FROM LOW BEAM RELAY, PAGE 5

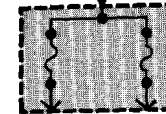

POWER DISTRIBUTION BOX

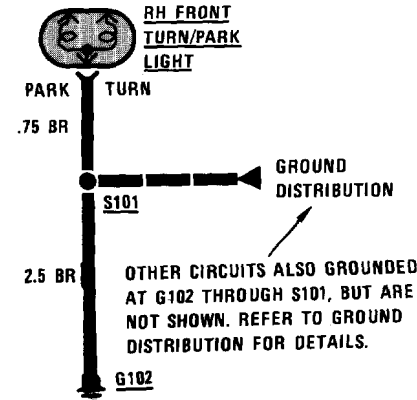

RH FRONT TURN/PARK LIGHT

PARK TURN

.75 BR

S101

2.5 BR

G102

GROUND DISTRIBUTION

OTHER CIRCUITS ALSO GROUNDED AT G102 THROUGH S101, BUT ARE NOT SHOWN. REFER TO GROUND DISTRIBUTION FOR DETAILS.



LIGHT EMITTING DIODE

6 SYSTEMATIC TROUBLESHOOTING

TROUBLESHOOTING PROCEDURE

1. Verify the Problem

Operate the problem circuit to check the accuracy of the complaint. Note the symptoms of the inoperative circuit.

2. Analyze the Problem

Refer to the schematic of the problem circuit in the ETM. Determine how the circuit is supposed to work by tracing the current path(s) from the power feed through the circuit components to ground. Then based on the symptoms you noted in step 1 and your understanding of circuit operation, identify one or more possible causes of the problem.

3. Isolate the Problem

Make circuit tests to prove or disprove the preliminary diagnosis made in step 2. Keep in mind that a logical simple procedure is the key to efficient troubleshooting. Test for the most likely cause of failure first. Try to make tests at points which are easily accessible.

4. Repair the Problem

Once the specific problem is identified, make the repair using the proper tools and safe procedures.

5. Check the Problem

Operate the circuit to check for satisfactory circuit operation. Good repair practice calls for rechecking all circuits you have worked on.

TROUBLESHOOTING TOOLS

Isolating the problem (Step 3 of TROUBLESHOOTING PROCEDURES) requires the use of a **voltmeter** and/or **ohmmeter**. A voltmeter measures voltage at selected points in a circuit. An ohmmeter measures a circuit's resistance to current flow. It has an internal battery that provides current to the circuit under test. Disconnect the car battery when using an ohmmeter because the battery voltage will cause the ohmmeter to give false readings. Also, do not use an ohmmeter on solid-state components. The voltage that the ohmmeter applies to the circuit could damage these components.

TROUBLESHOOTING TESTS

Voltage Test

This test measures voltage in a circuit. By taking measurements at several points (terminals or connectors) along the circuit, you can isolate the problem.

To take a voltage measurement, connect the negative lead of the voltmeter to the battery's negative terminal or other known good ground. Then connect the positive lead of the voltmeter to the point you want to test. The voltmeter will measure the voltage present at that point in the circuit.

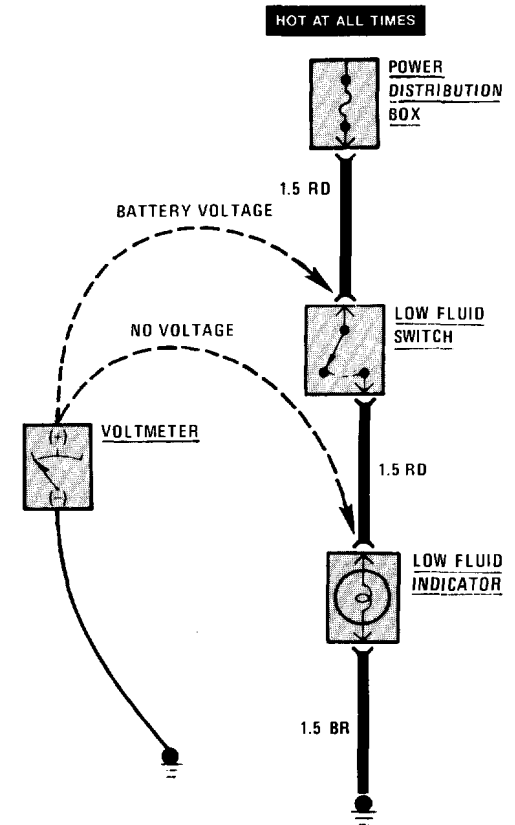

Voltage Test

Voltage Drop Test

Wires, connectors, and switches are designed to conduct current with a minimum loss of voltage. A voltage drop of more than one volt indicates a problem.

To test for voltage drop, connect the voltmeter leads to connectors at either end of the circuit's suspected problem area. The positive lead should be connected to the connector closest to the power source. The voltmeter will show the voltage drop between these two points.

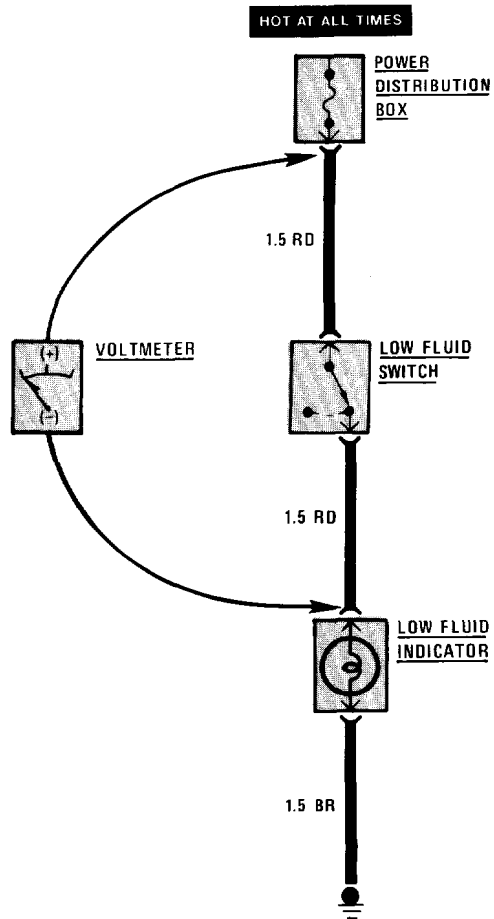

Voltage Drop Test

Continuity Test

To perform a continuity test, first disconnect the car battery. Then adjust the ohmmeter to read zero while holding the leads together. Connect the ohmmeter leads to connector or terminals at either end of the circuit's suspected problem area. The ohmmeter will show the resistance across that part of the circuit.

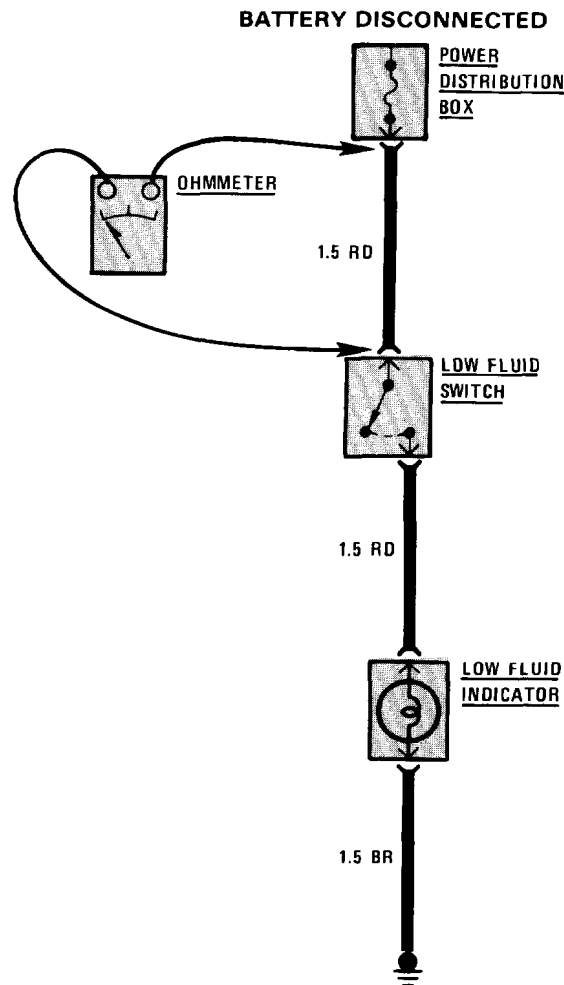

Continuity Test

Short Test Using Voltmeter

Remove the blown fuse and disconnect the load. Connect the voltmeter leads to the fuse terminals. The positive lead should be connected to the terminal closest to the power source.

Starting near the POWER DISTRIBUTION BOX, move the wire harness back and forth and watch the voltmeter reading. If the voltmeter registers a reading, there is a short to ground in the wiring. Somewhere in the area of the harness being moved, the wire insulation is worn away and the circuit is grounding.

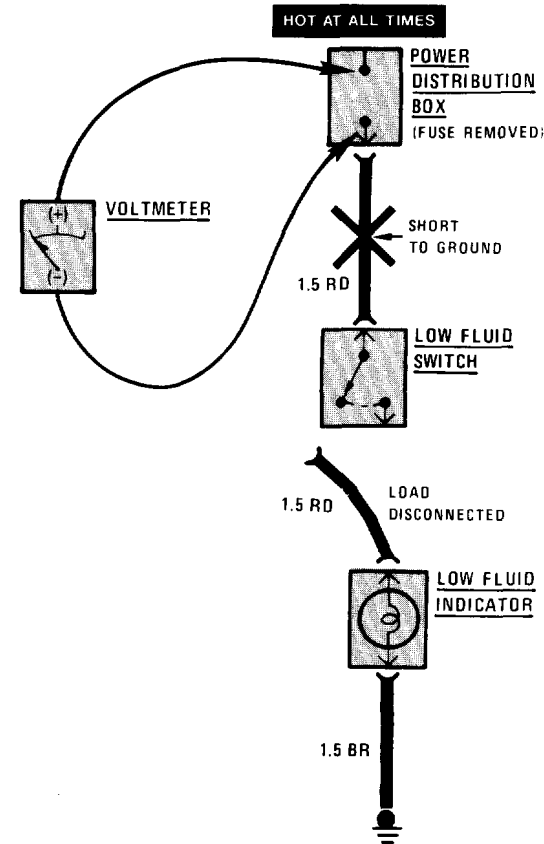

Short Test Using Voltmeter

8 SYSTEMATIC TROUBLESHOOTING

Short Test Using Ohmmeter

Disconnect the battery. Adjust the ohmmeter to read zero while holding the leads together. Remove the blown fuse and disconnect the load. Connect one lead of the ohmmeter to the fuse terminal that is closest to the load. Connect the other lead to a known good ground.

Starting near the POWER DISTRIBUTION BOX, move the wire harness back and forth and watch the ohmmeter reading. Low or no resistance indicates a short to ground in the wiring. Infinitely high resistance indicates no short.

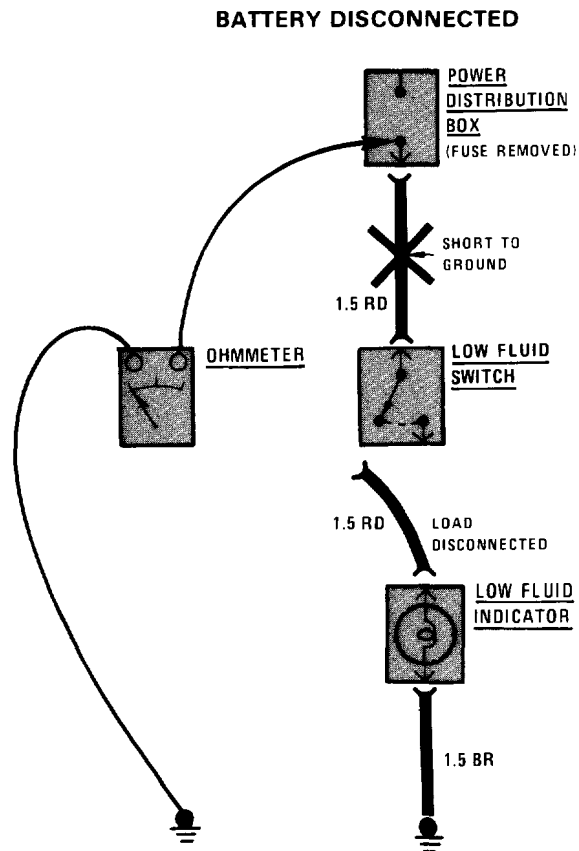

Short Test Using Ohmmeter

POWER DISTRIBUTION BOX

NOTE
 On some cars, the position of the side mounted relays may be interchanged on their respective sides. Check relay wire colors for positive identification.

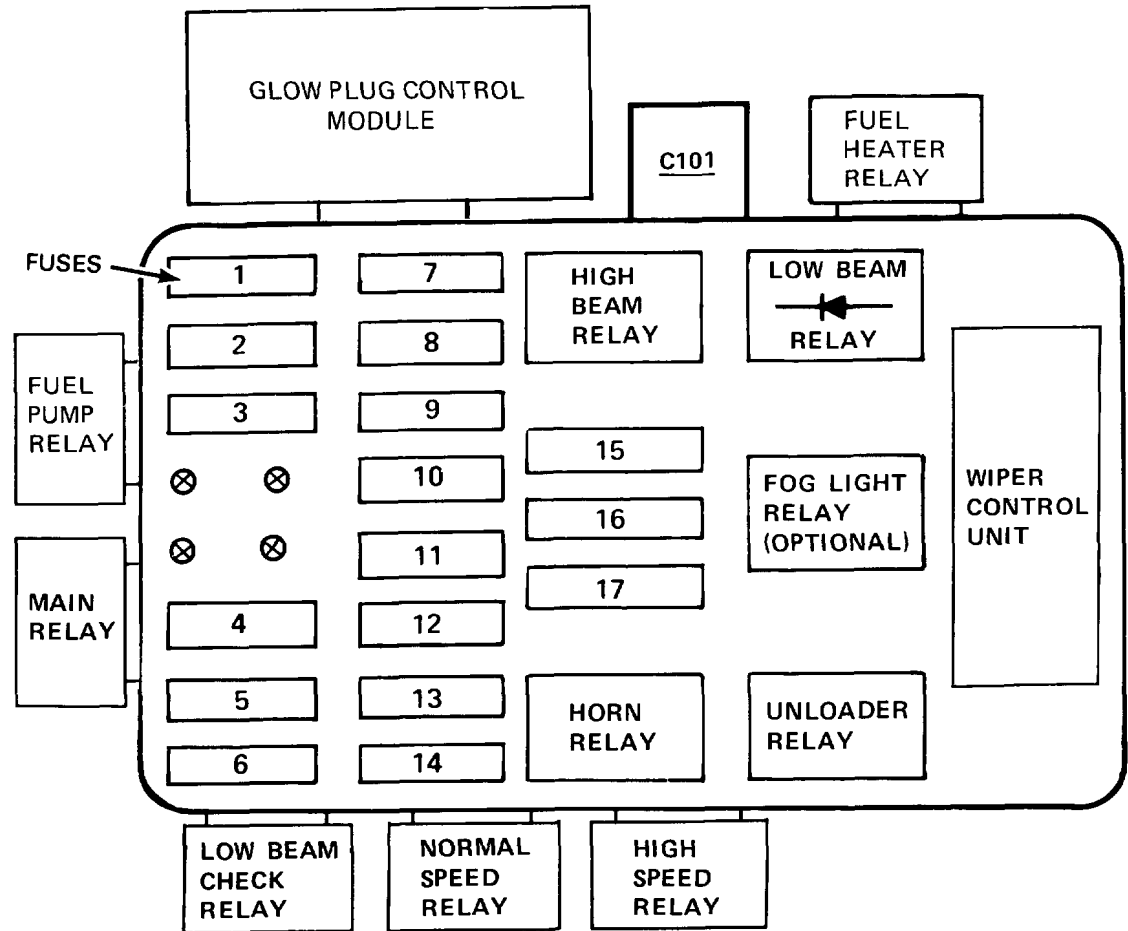
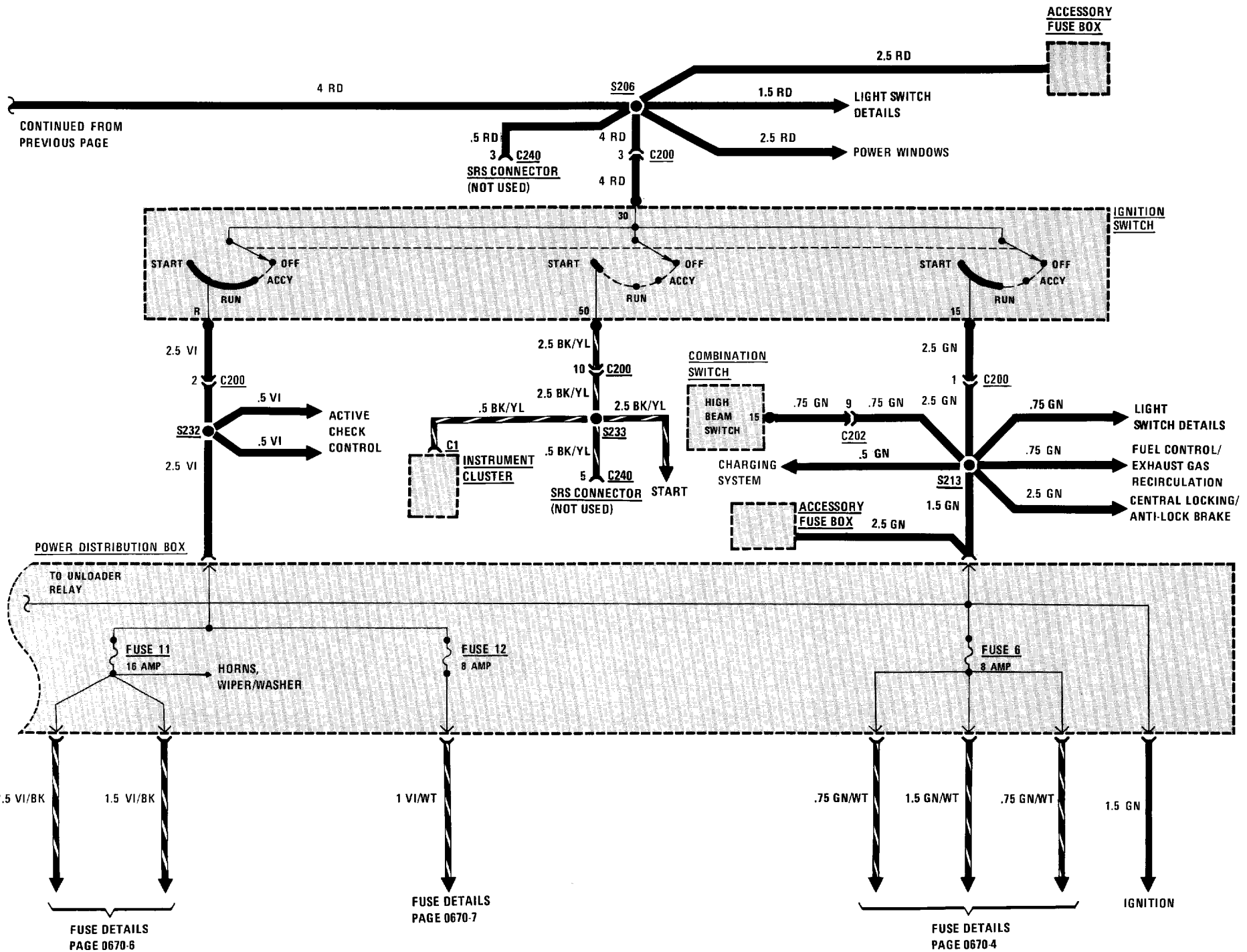

Figure 1- Top Of Left Front Wheel Well

Fuse No.	Size/Color	Circuit Name
1	16A (RD)	Fuel Delivery/Evaporative Control.
2	8A (WT)	Active Check Control (also fuses 3, 5, 6, 9, 10, 11, 12); Headlights (RH Low Beam).
3	8A (WT)	Active Check Control (also fuses 2, 5, 6, 9, 10, 11, 12); Headlights (LH Low Beam).
4	25A (BU)	Cigar Lighter; Radio/Power Antenna (also fuses 5, 12); Power Seats.
5	8A (WT)	Active Check Control (also fuses 2, 3, 6, 9, 10, 11, 12); Central Locking; Heated Door Locks; Ignition Key Warning/Seatbelt Warning (also fuse 6); Interior Lights (also fuse 6); Lights: Turn/Hazard Warning (also fuse 11); Lights: Trunk; Gauges (also fuse 6); Glove Box/Auto-Charging Flashlight; Multifunction Clock (also fuses 6); Service Interval Indicator (also fuse 6).
6	8A (WT)	Active Check Control (also fuses 2, 3, 5, 9, 10, 11, 12); Back Up Lights/Transmission Range Lights; Fuel Delivery; Cruise Control (also fuse 12); Dash Lights (also fuses 9, 14); Fog Lights (also fuses 15, 16); Gauges (also fuse 5); Heater and A/C (also fuse 14); Idle Speed Control; Ignition, Key Warning/Seatbelt Warning (also fuse 5); Interior Lights (also fuse 5); Multifunction Clock (also fuse 5); Power Mirrors; Power Windows (also Power Window Circuit Breaker); Glow Plug Control; Service Interval Indicator (also fuse 5); Speedometer; Warning Indicators.
7	8A (WT)	Headlights (RH High Beams).

Fuse No.	Size/Color	Circuit Name
8	8A (WT)	Headlights (LH High Beams).
9	8A (WT)	Active Check Control (also fuses 2, 3, 5, 6, 10, 11, 12); Dash Lights (also fuses 6, 14); Lights: Front Park/Front Marker/Tail: (also fuse 10); Lights: Rear Marker/License: (also fuse 10).
10	8A (WT)	Active Check Control (also fuses 2, 3, 5, 6, 9, 11, 12); Lights: Front Park/Front Marker/Tail (also fuse 9); Lights: Rear Marker/License (also fuse 9).
11	16A (RD)	Active Check Control (also fuses 2, 3, 5, 6, 9, 10, 12); Lights: Turn/Hazard Warning (also fuse 5); Wiper/Washer and Heater Washer Jets; Horn
12	8A (WT)	Active Check Control (also fuses 2, 3, 5, 6, 9, 10, 11); Cruise Control (also fuse 6); Radio (also fuses 4, 5); Stoplights; Radio; Power Antenna (also fuses 4, 5).
13	16A (RD)	Rear Defogger; Sunroof.
14	25A (BU)	Auxiliary Fan (also fuse 17); Dash Lights (also fuses 6, 9); Heater and A/C (also fuse 6).
15	8A (WT)	Fog Lights (RH).
16	8A (WT)	Fog Lights (LH).
17	25A (BU)	Auxiliary Fan (also fuse 14).
Power Window Circuit Breaker	25A (BU)	Power Windows (also fuse 6).



FUSE DETAILS: FUSE 6

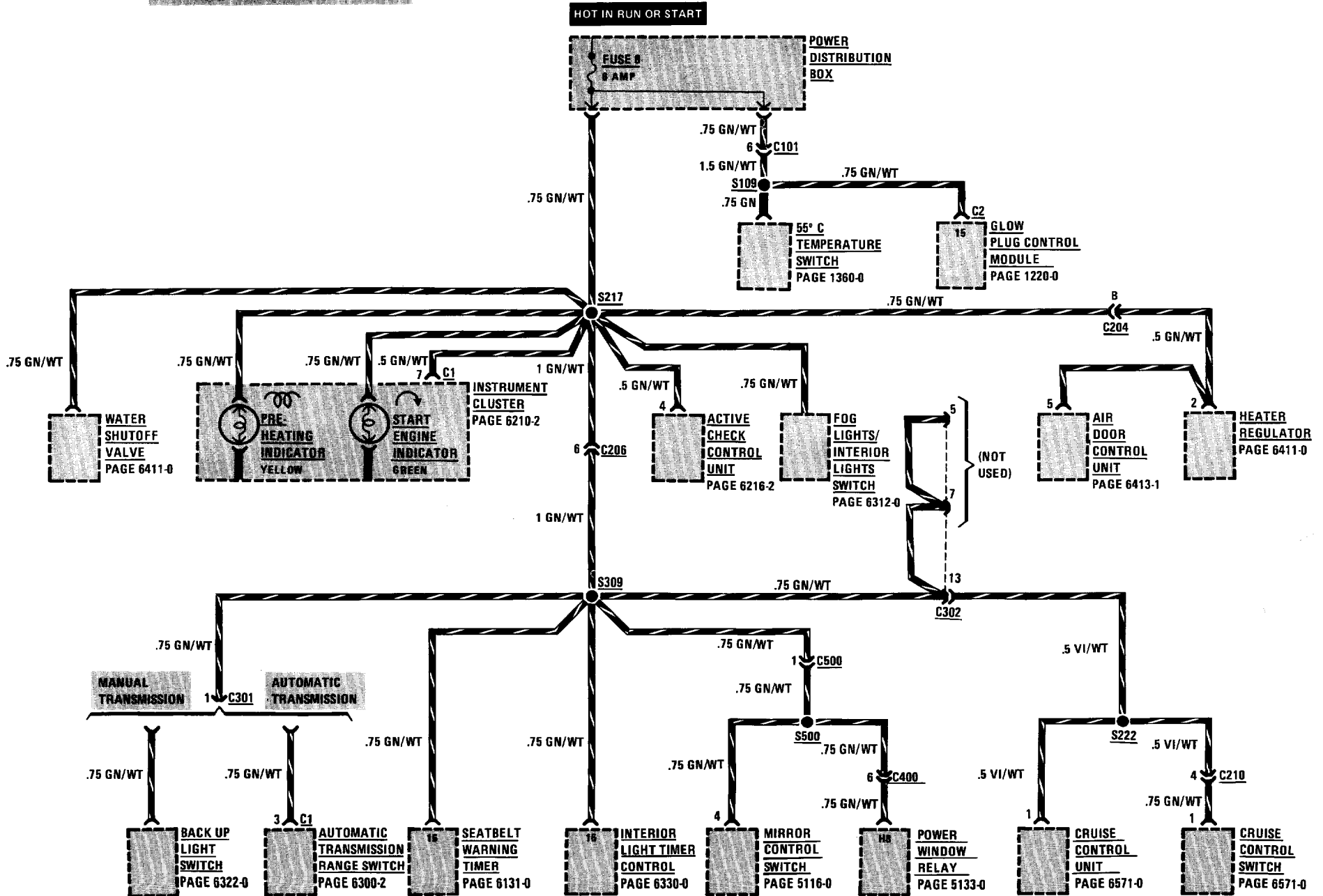

FUSE DETAILS: FUSES 4, 17 and 13

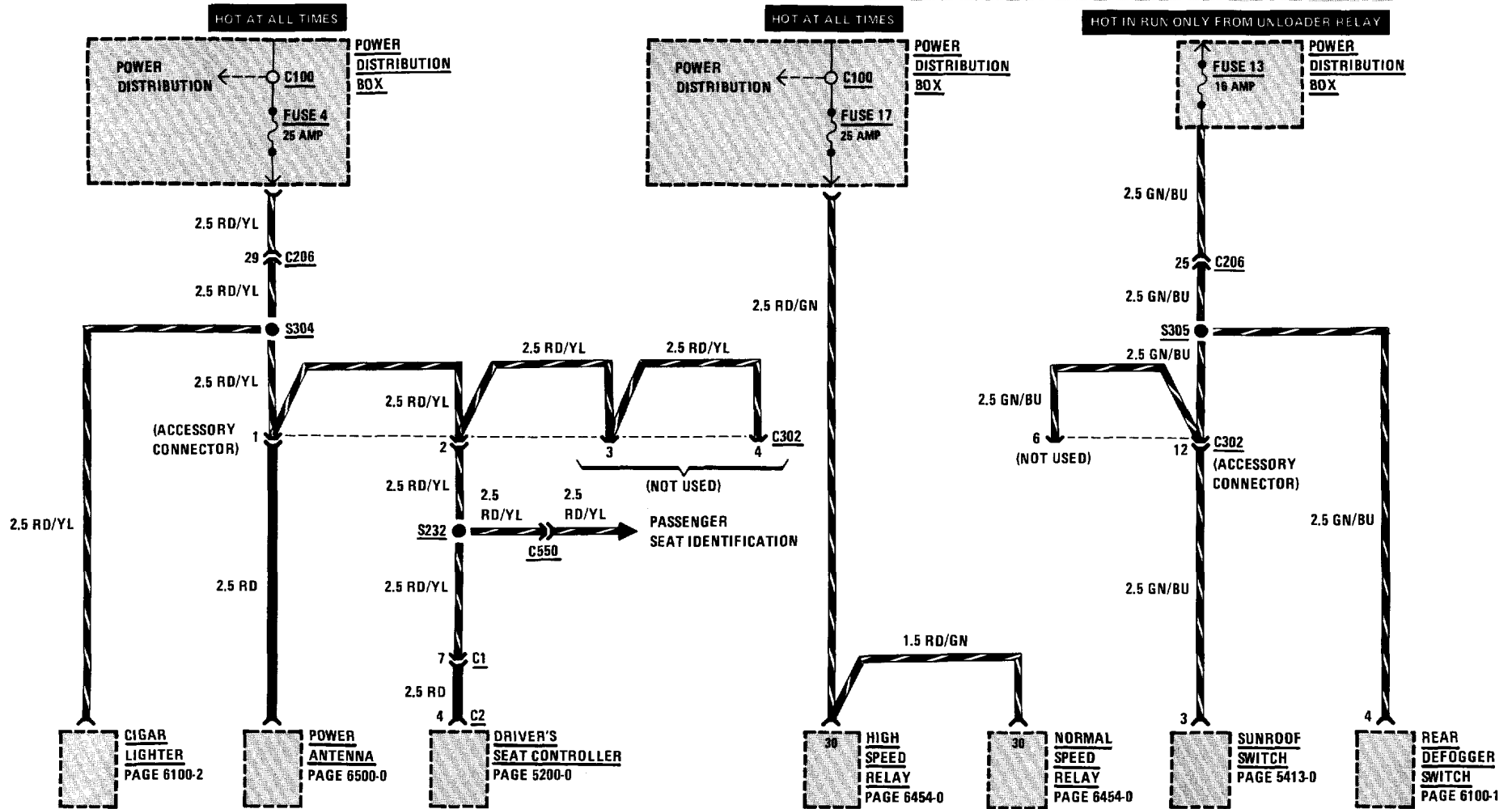

FUSE DETAILS: FUSE 11

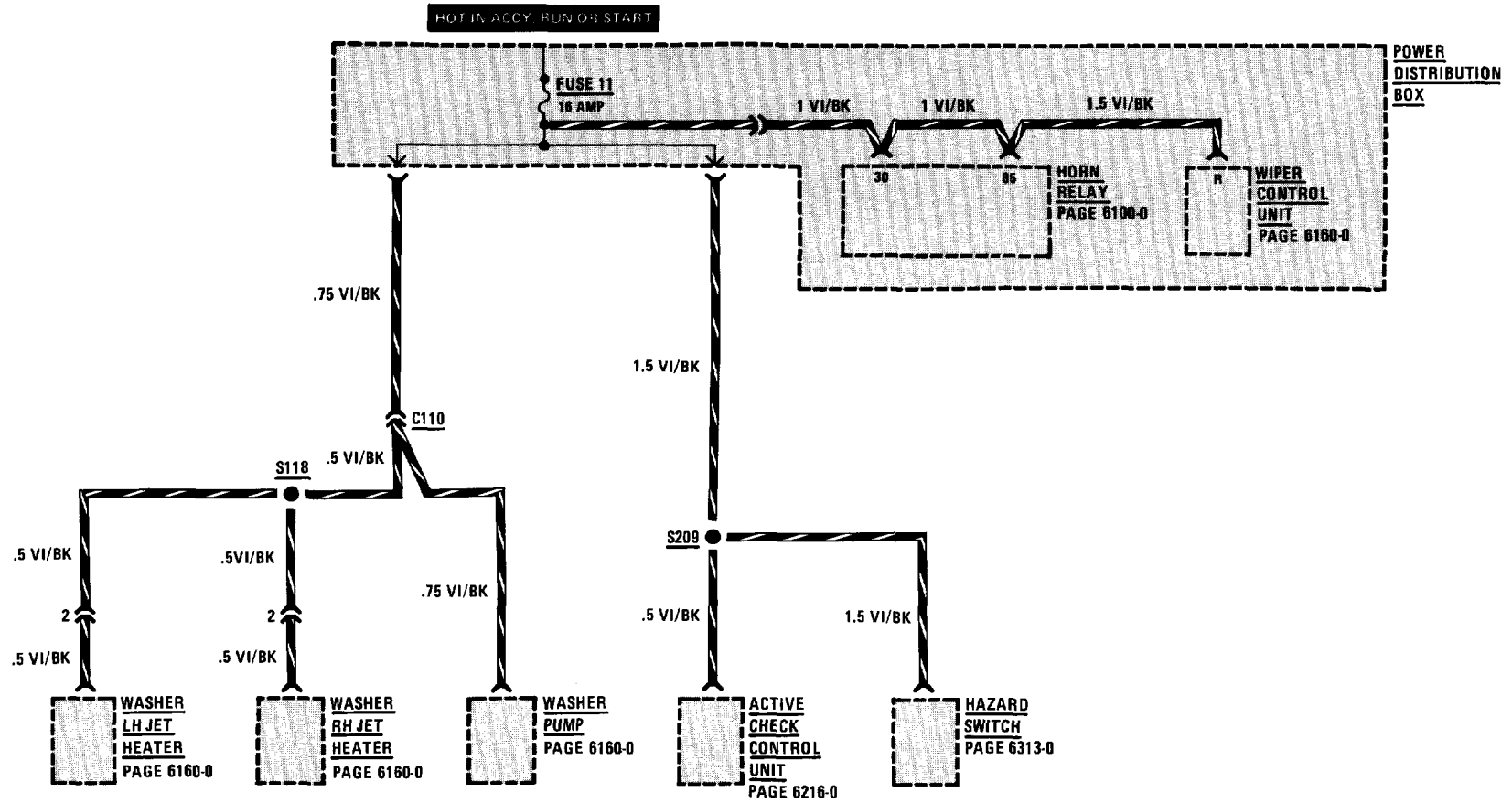

FUSE DETAILS: FUSES 12 AND 14

HOT IN RUN ONLY FROM UNLOADER RELAY

HOT IN ACCY. RUN OR START

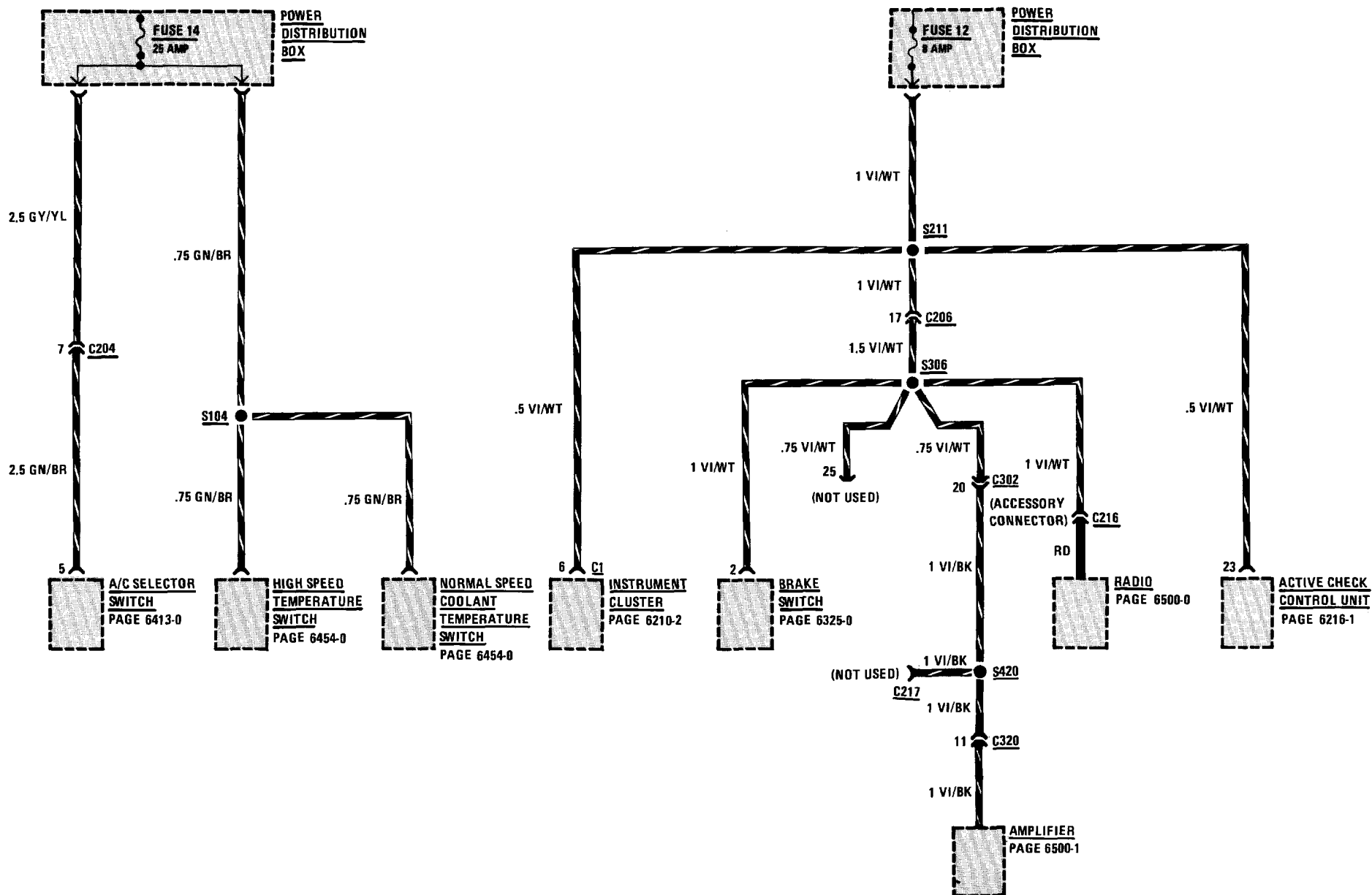

GROUND DISTRIBUTION (G102)

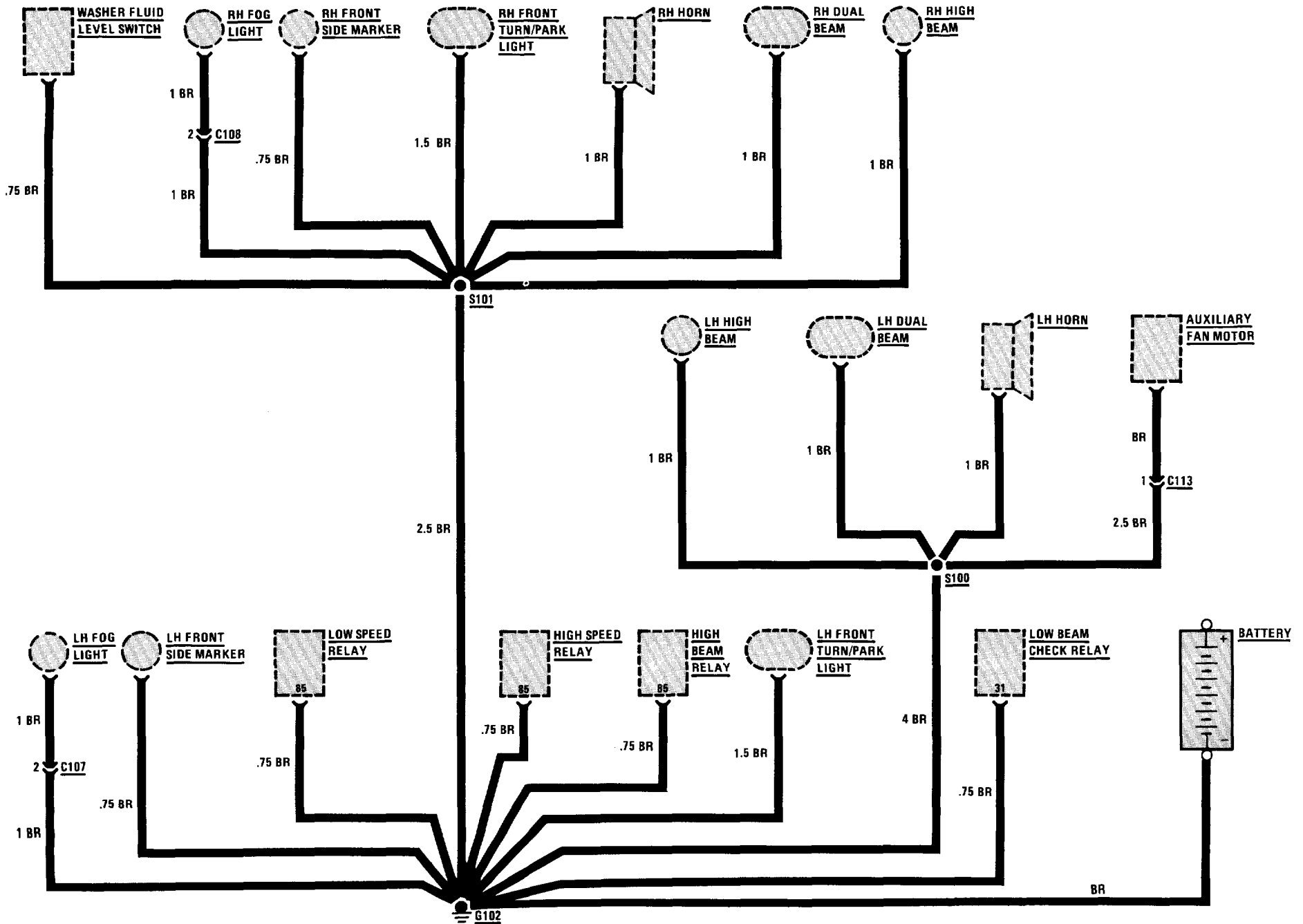

GROUND DISTRIBUTION (G103 AND G301)

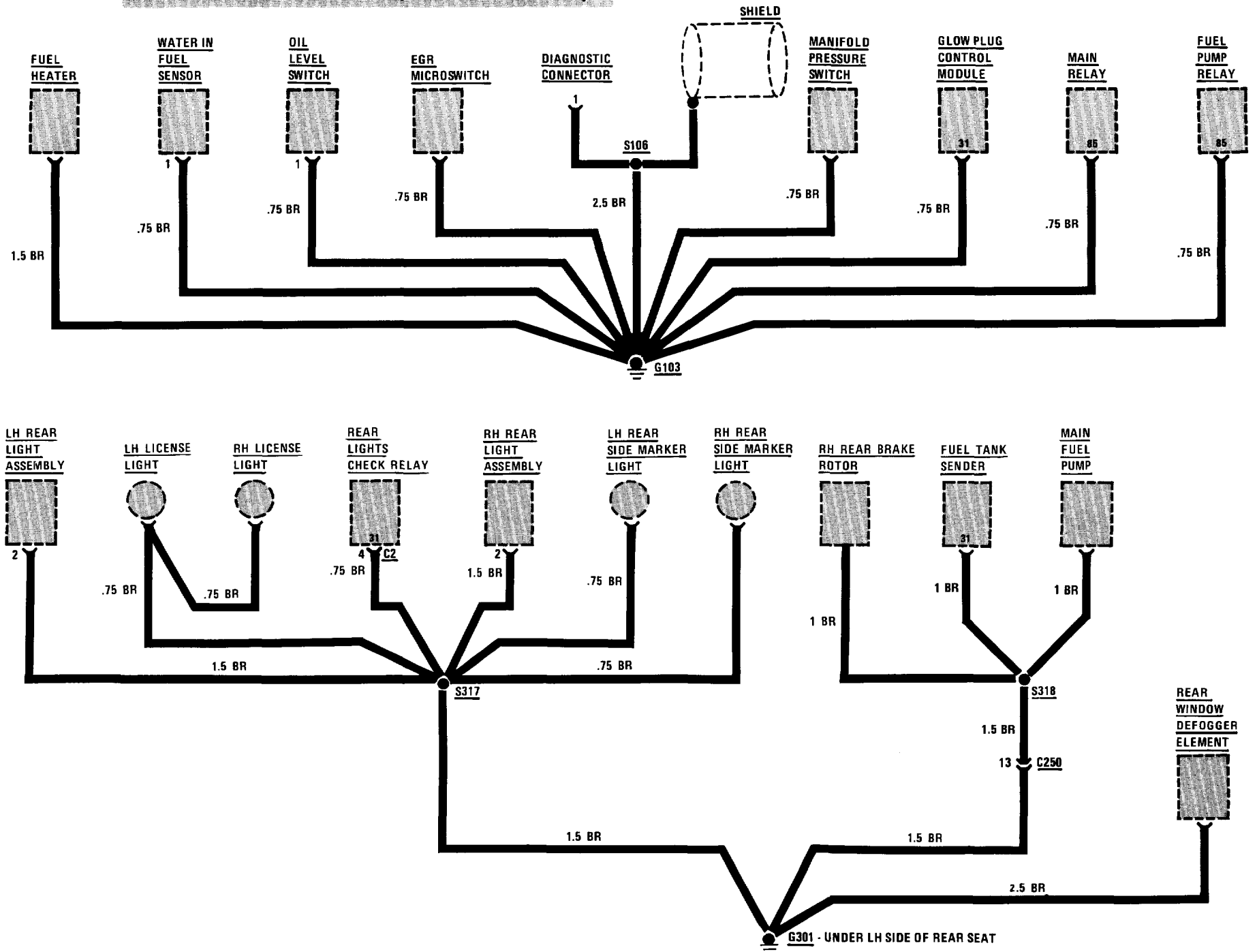

GROUND DISTRIBUTION (G200)

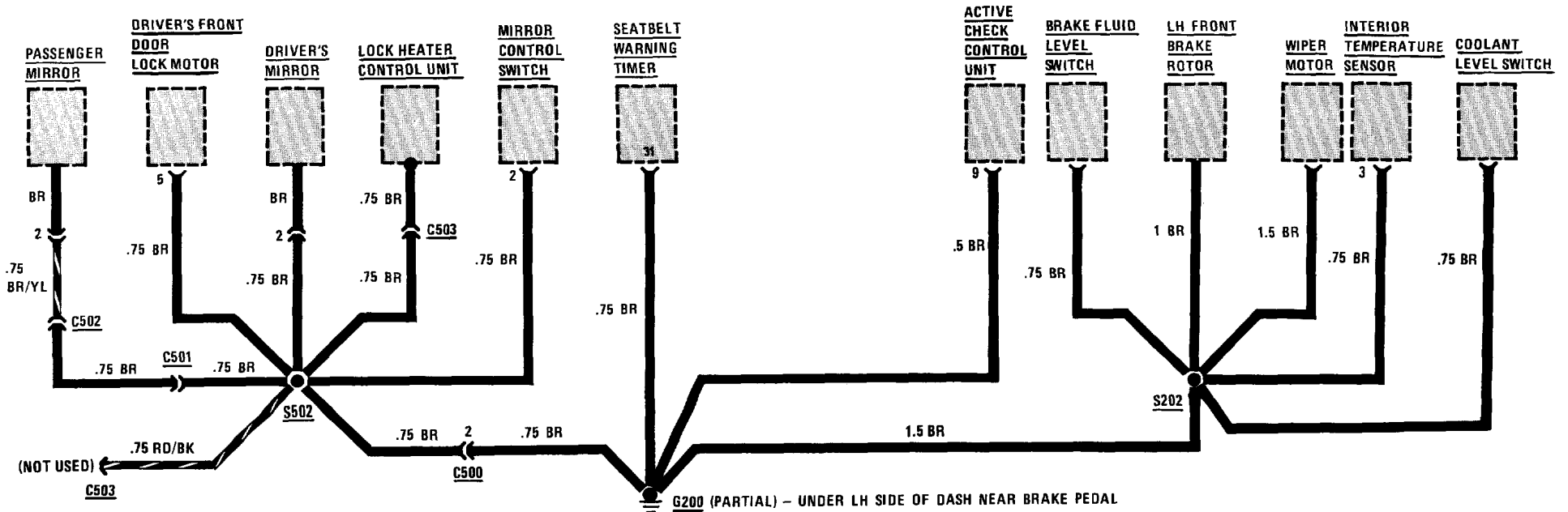
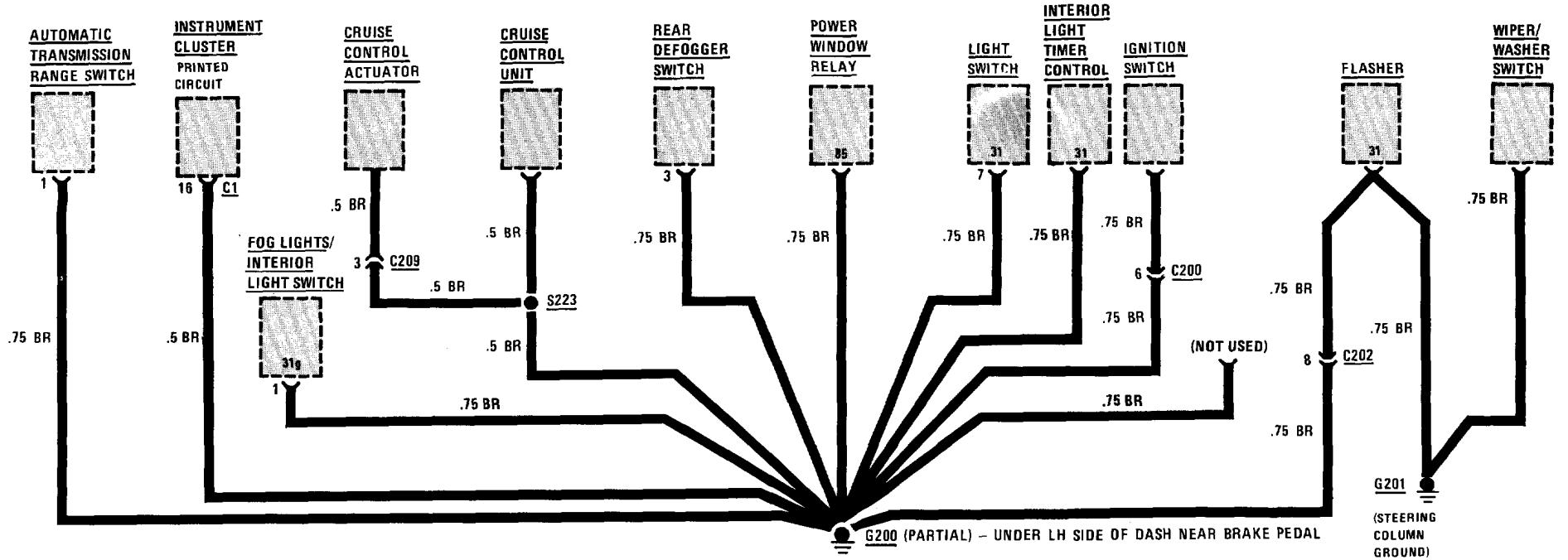

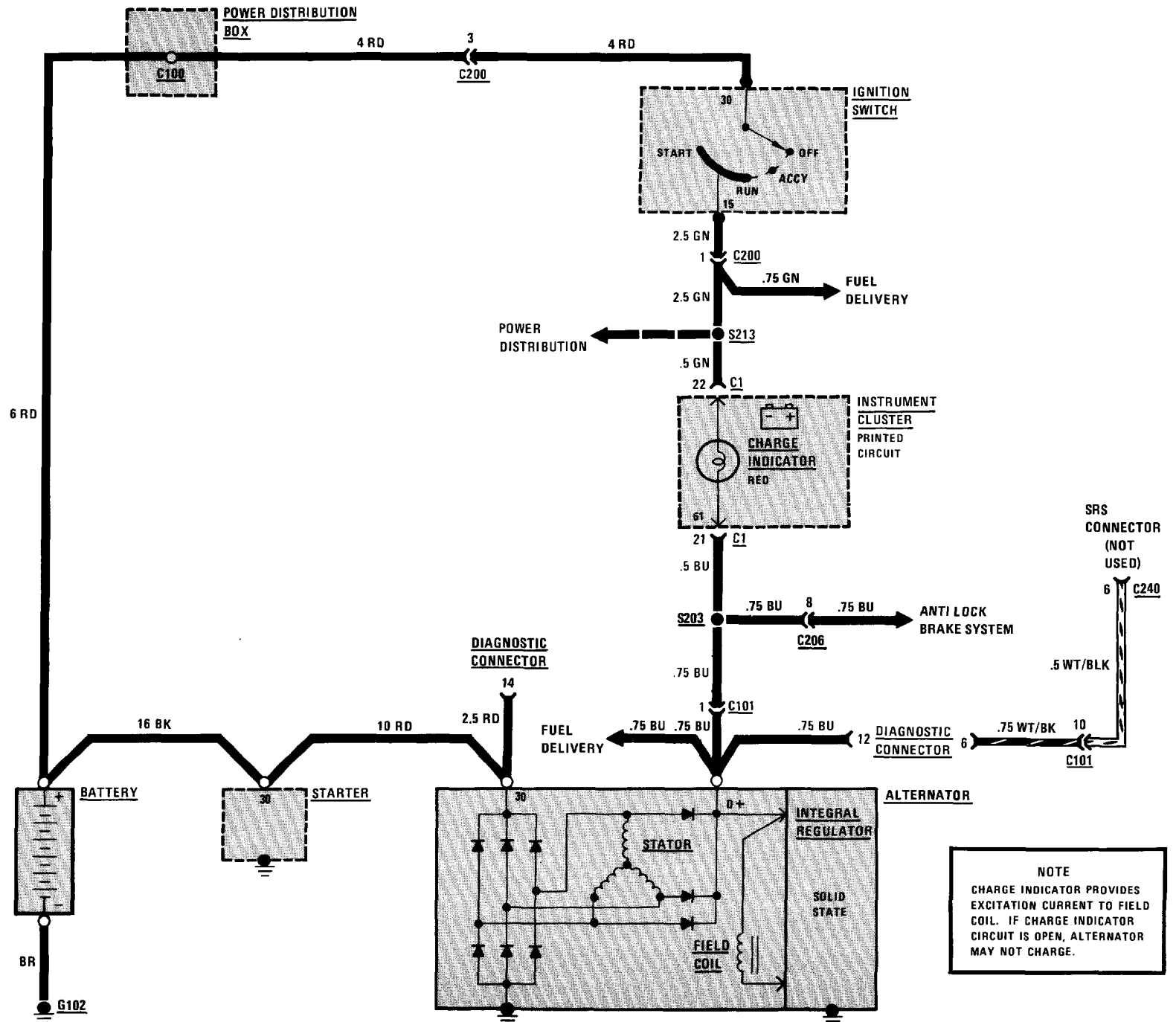

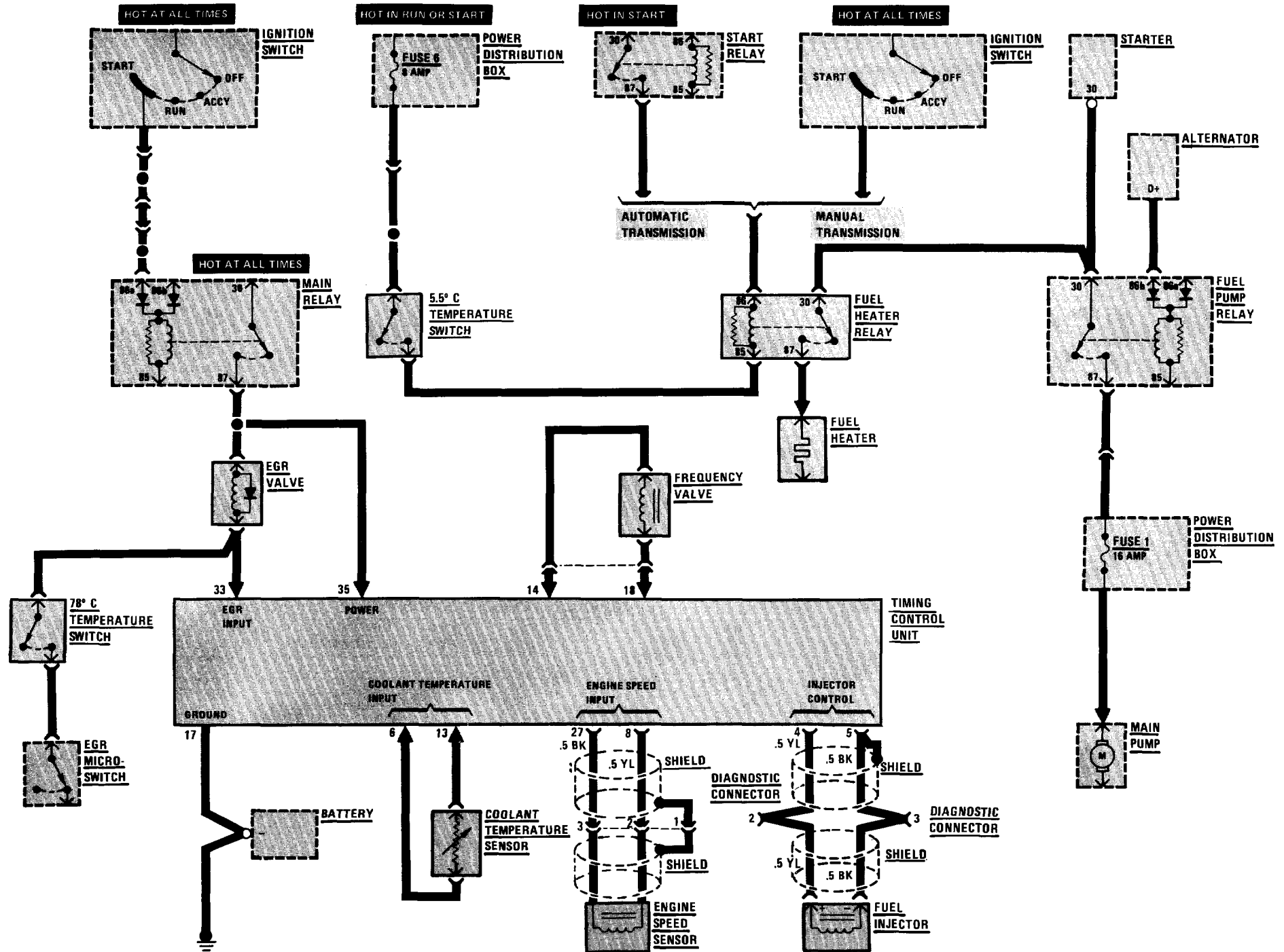

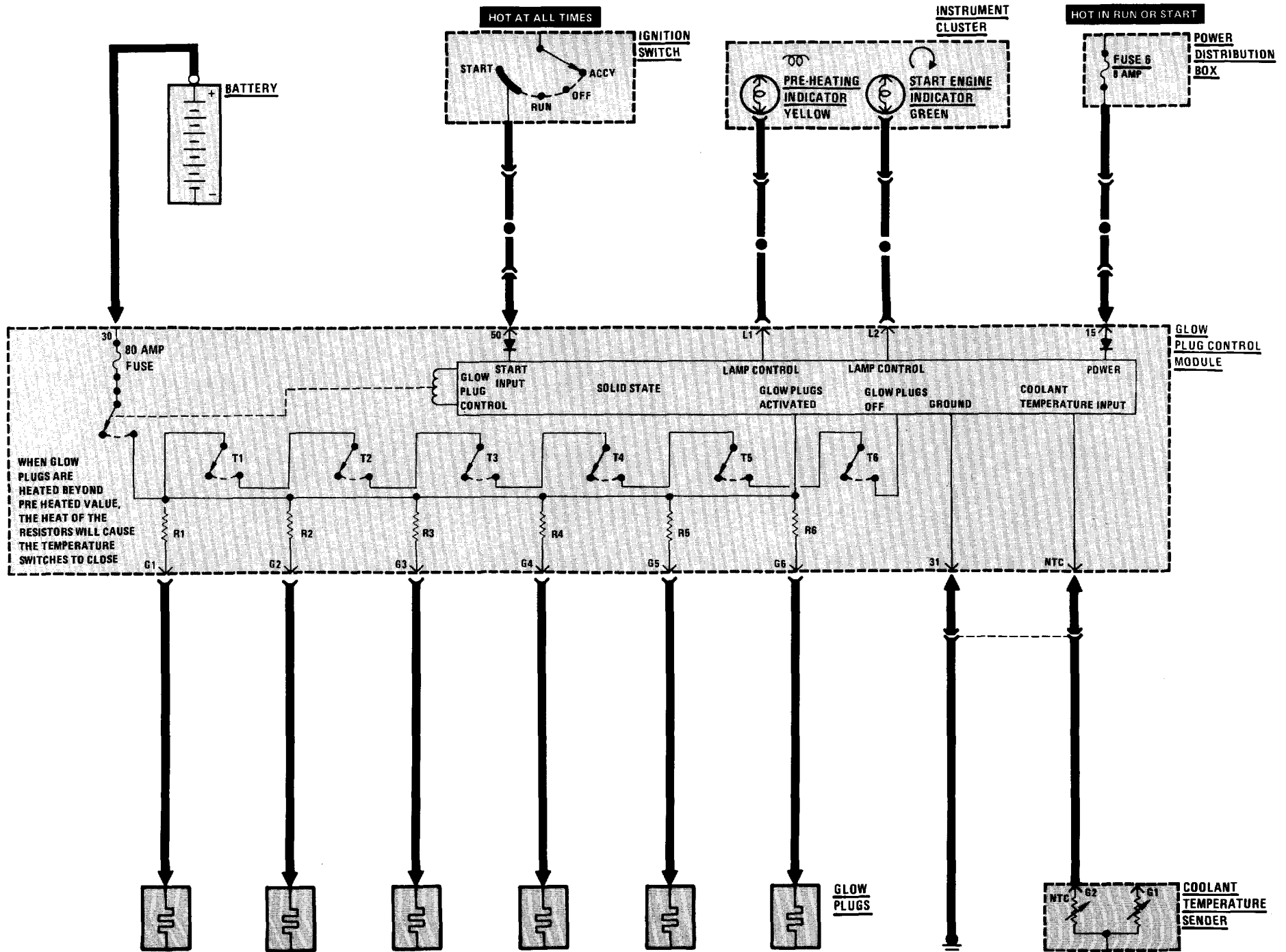

FUEL DELIVERY

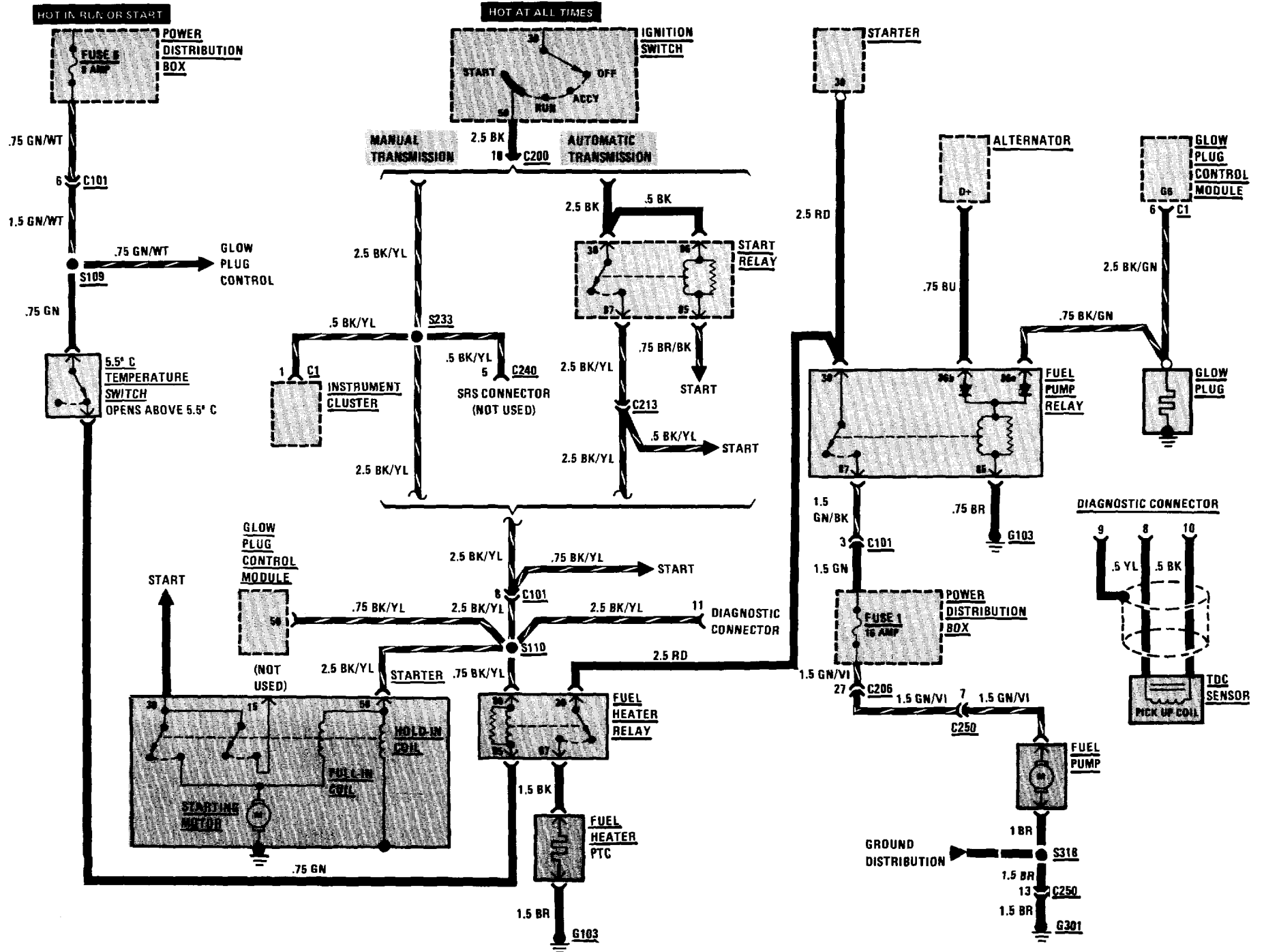

FUEL CONTROL/EXHAUST GAS RECIRCULATION

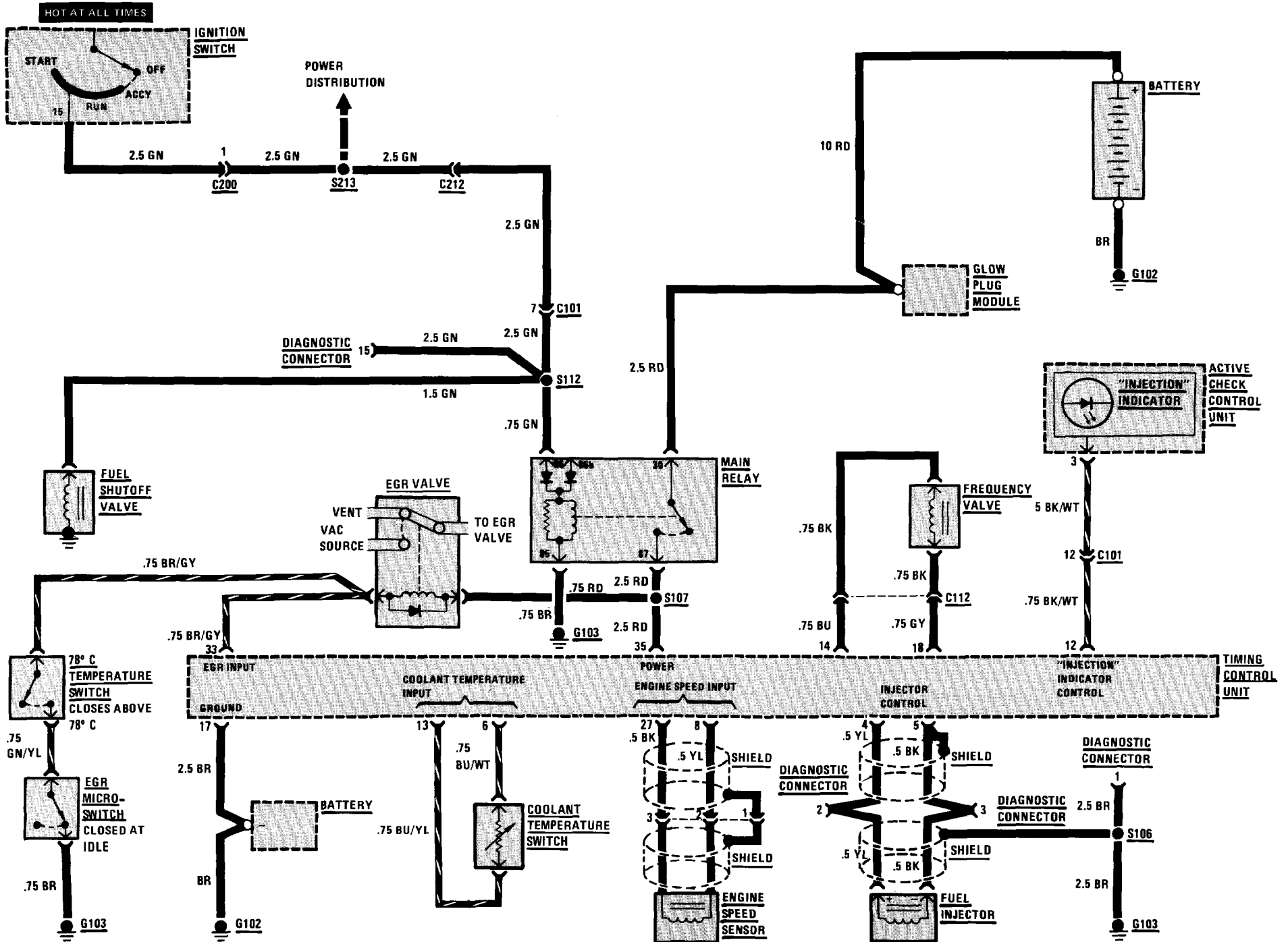

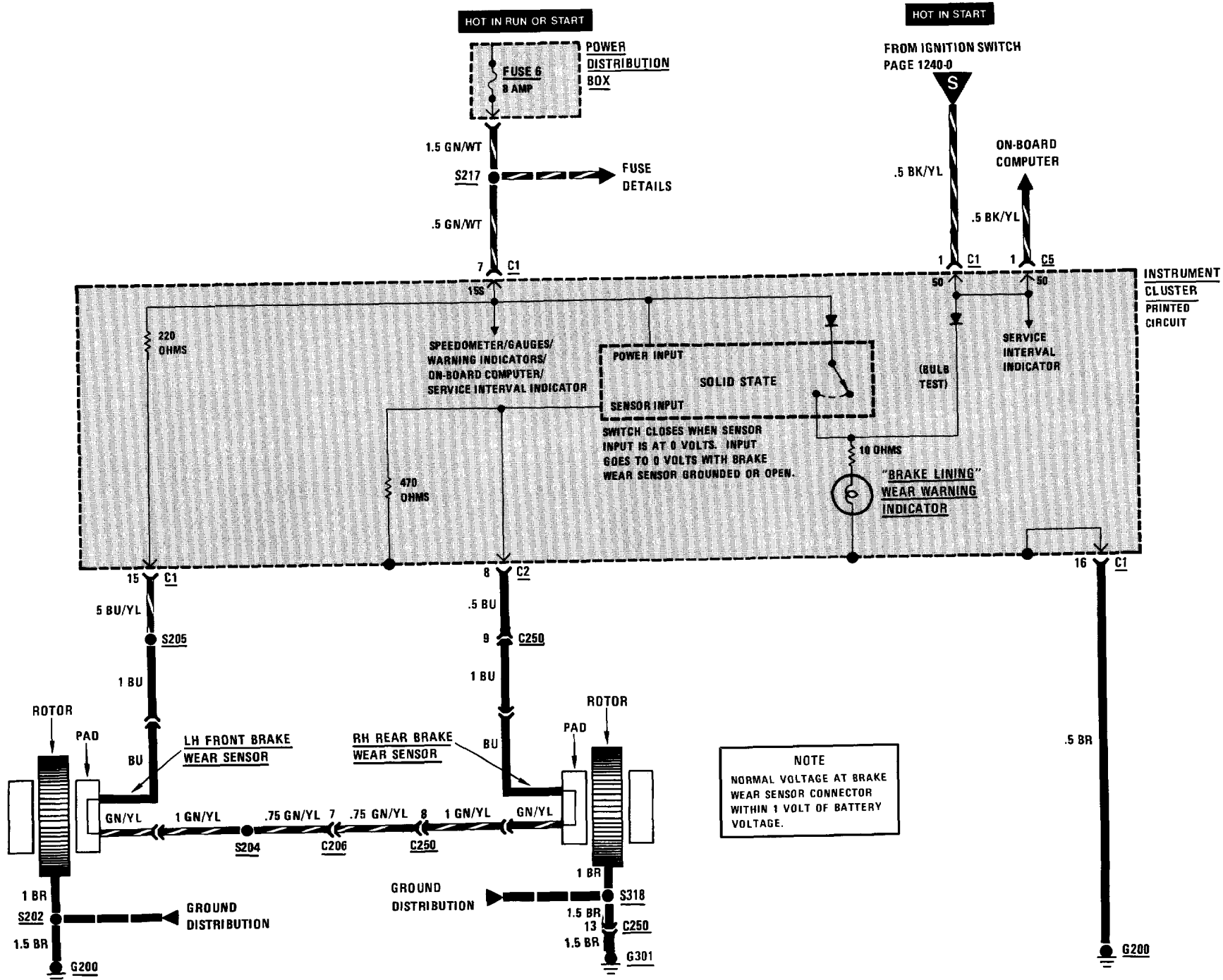

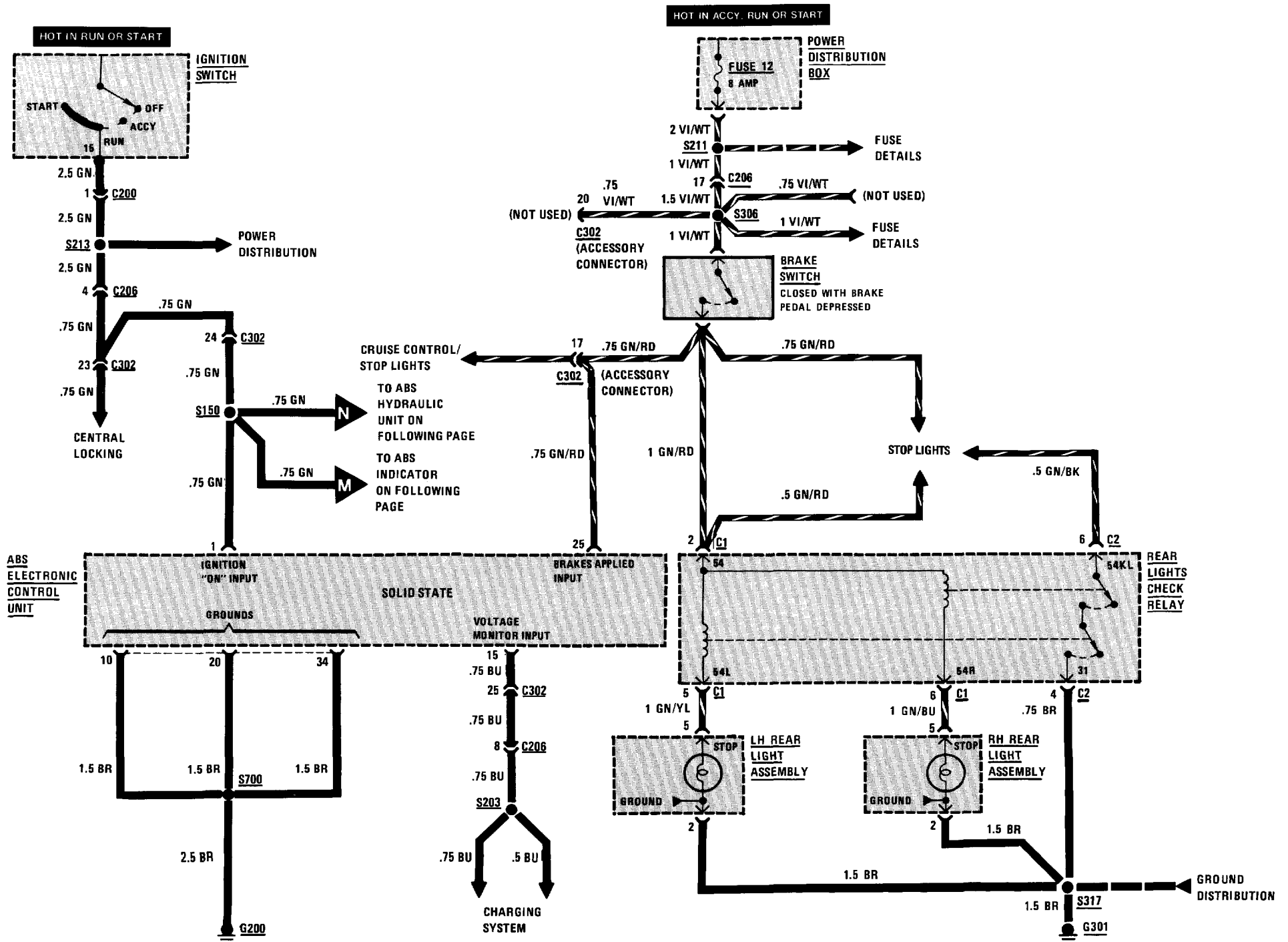

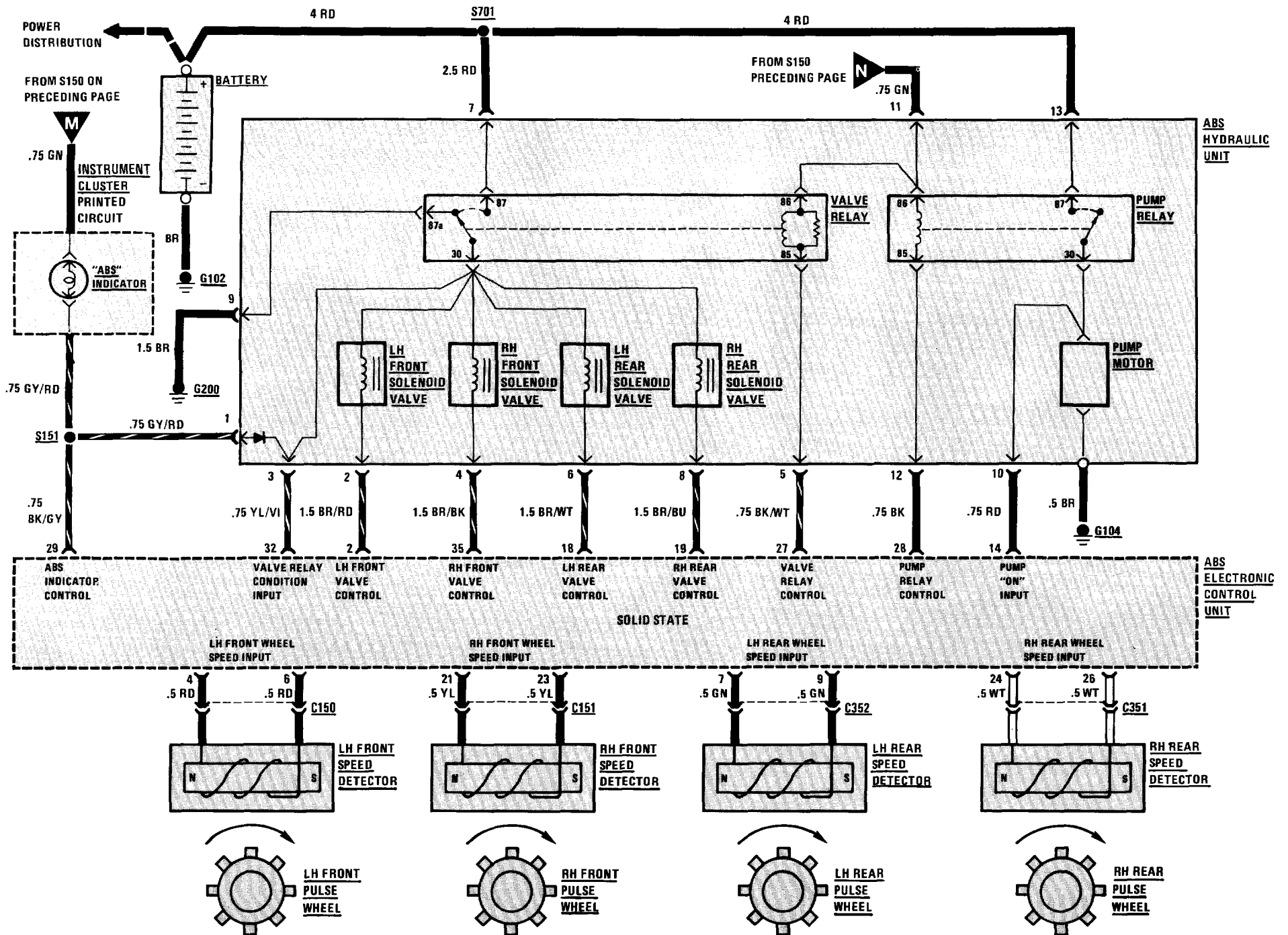

HOT IN RUN OR START

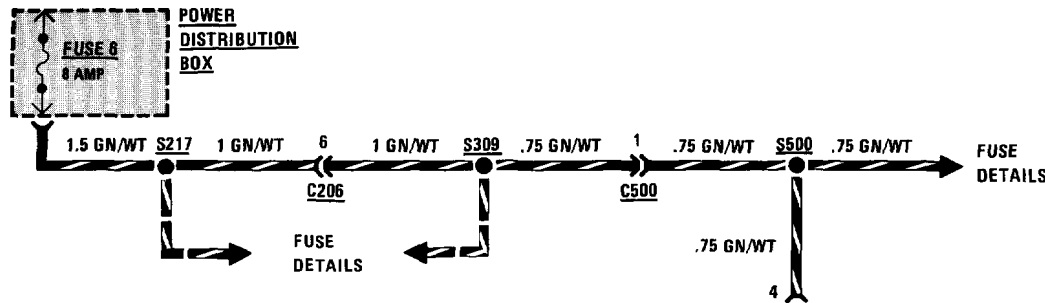

1. MOTOR DIRECTION CONTROLLED BY POLARITY
2. WITH CLUTCH SOLENOID ENERGIZED MOTOR TURNS MIRROR LEFT OR RIGHT
3. ELECTRICALLY HEATED MIRROR TURNS ON BELOW $59 \pm 9^\circ \text{F}$ AND TURNS OFF ABOVE $122 \pm 18^\circ \text{F}$

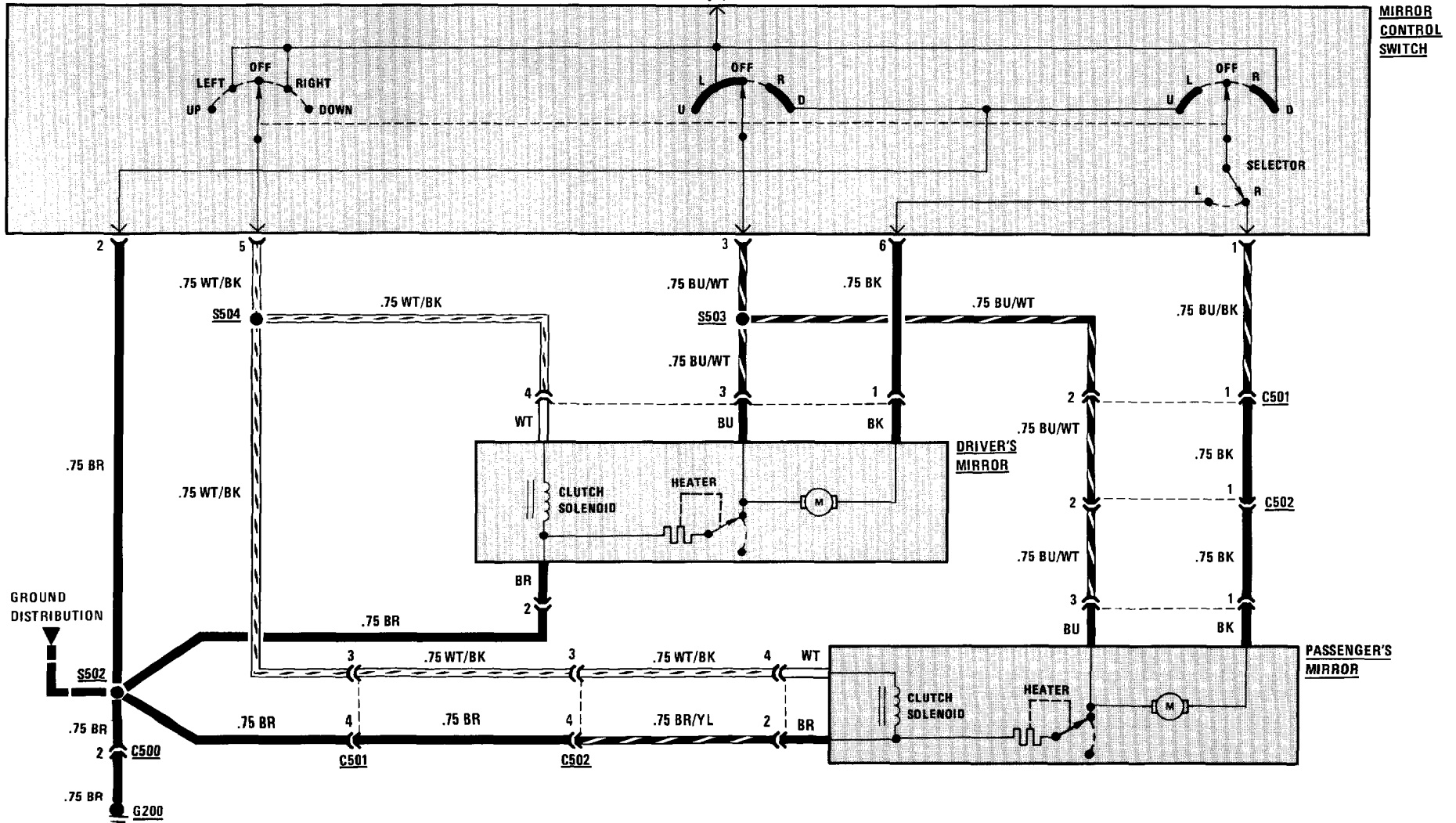

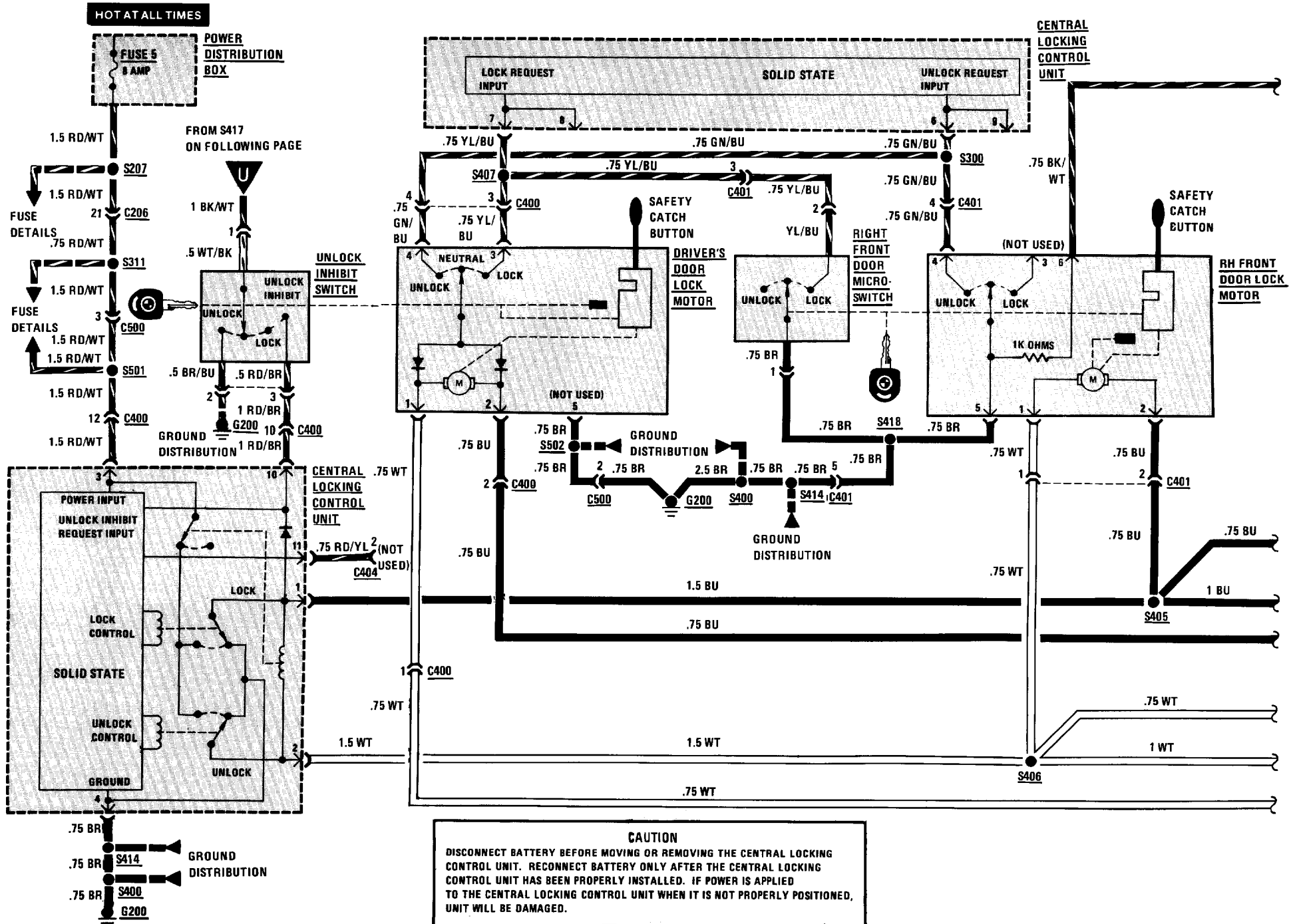

TROUBLESHOOTING HINTS

- 1. Check Fuse 5 by operating the Digital Radio.

SYSTEM CHECK

- Operate controls in sequence listed in the System Check Table.
- Refer to Repair Action for the Response received (Tests follow the System Check Table).
- After any repair, repeat System Check to verify proper system operation.

NOTE: Before replacing any system component, check all connectors, splices, and wiring to that component.

COMPONENT LOCATION

		Page-Figure
Central Locking Control Unit	Behind RH kick panel, above speaker	7000-8-5
Driver's Door Lock Motors	Center Rear of respective door	7000-6-6
Gas Filler Lock Motor	In trunk, right of power antenna	7000-7-4
Ignition Switch	Upper part of steering column	7000-3-4
LH Rear Door Lock Motor	In LH rear door	7000-6-6
Power Distribution Box	On LH front wheel well	7000-0-2
RH Front Door Lock Motor	In RH front door	7000-6-6
RH Rear Door Lock Motor	In RH rear door	7000-6-6
Right Front Door Micro Switch	Inside door, on door lock	
Trunk Lock Motor	In rear panel of trunk	7000-7-3
Unlock Inhibit Switch	In LH front door, on door lock cylinder	
C200 (10 pin)	On LH side of steering column	7000-3-5
C206 (29 pin)	On connector bracket, under LH side of dash	7000-4-4
C302 (Accessory Connector)	Under LH side of dash	7000-4-6
C400 (13 pin)	Behind LH front speaker	7000-5-3
C401 (13 pin)	Behind RH front speaker	7000-8-5
C402 (7 pin)	In LH B pillar	
C403 (7 pin)	In RH B pillar	7000-5-6
C404 (5 pin)	Under LH side of dash, against kick panel	7000-4-6
C405 (2 pin)	In trunk, near trunk lock	
C500 (6 pin)	Behind LH front speaker	7000-5-3
G200 (Front Interior Ground)	Under LH side of dash, near top of brake pedal	

SYSTEM CHECK TABLE

OPERATION	CORRECT RESPONSE	REPAIR ACTION
1. Insert the key in the Driver's door and turn to LOCK	All doors lock	None, proceed to Operation 2
	Some doors lock	Repair/replace the suspect Door Lock Motor circuit
	No doors lock	Proceed to Operation 4
2. Turn the key to UNLOCK INHIBIT (clockwise until key is horizontal)	All doors double lock (Safety Catch Buttons cannot be pulled up by hand)	None, proceed to Operation 3
	Driver's door double locks and only some of the other doors double lock	Repair/replace the suspect Door Lock Motor
	Driver's door double locks but all the other doors do not double lock	Turn key to UNLOCK. If any door unlocks, check RD/BR wire and Unlock Inhibit Switch. If no doors unlock, proceed to Test B.
	Driver's door does not double lock	Mechanical problem, see BMW Troubleshooting Manual

SYSTEM CHECK TABLE (CONT'D)

OPERATION	RESPONSE	REPAIR ACTION
3. Turn the key to UNLOCK	All doors unlock	None, proceed to Operation 4
	Some doors unlock	Repair/replace the suspect Door Lock Motor circuit
	No doors unlock	Proceed to Operation 5
4. Insert the key in the Passenger's door and turn to LOCK	All doors lock	If the doors did not lock in Operation 1, repair/replace the Driver's Door Lock Switch, otherwise proceed to Operation 5
	Some doors lock	Repair/replace the suspect Door Lock Motor circuit
	No doors lock	If all the doors locked in Operation 1, repair/replace the Right Front Door Microswitch. If the doors did not lock in Operation 1, perform Test A
5. Insert the key in the Passenger's door and turn to UNLOCK	All doors unlock	If all the doors did not unlock in Operation 3, repair/replace the Driver's Door Lock Switch, otherwise proceed to Operation 6
	Some doors unlock	Repair/replace the suspect Door Lock Motor
	No doors unlock	If all the doors unlocked in Operation 3, repair/replace the Passenger's Door Lock Switch. If the doors did not unlock in Operation 3, perform Test C
6. Get in the car and close and lock all doors Turn the Ignition Switch to RUN	Doors remain locked	None, proceed to Operation 7
	Doors unlock	Repair/replace the Central Locking Control Unit
7. Get out of the car Insert the key in the Driver's door and turn to LOCK Unlock each of the doors by pulling up the Safety Catch Buttons	All doors can be unlocked	None, proceed to Operation 8
	All doors remain secure	Disconnect the connector from the Central Locking Control Unit and check for a short to battery in the RD/BR, WT/BU, and BK/WT wires at terminal 10. <ul style="list-style-type: none"> • If short to battery is not present, replace the Unlock Inhibit Switch. • If short to battery is present, isolate wiring from Door Lock Motors one at a time to find short

SYSTEM CHECK TABLE (CONT'D)

OPERATION	RESPONSE	REPAIR ACTION
8. Insert the key in the Trunk Cylinder Switch. Turn the key to LOCK	Trunk locks	None, proceed to Operation 9
	Trunk does not lock	If the doors lock, repair/replace the Trunk Lock Motor Circuit or Trunk Lock Motor. If the doors do not lock, repair/replace the Trunk Switch. Repair/replace the Central Locking Control Unit if the Trunk Switch Circuit is OK
9. Turn the key to UNLOCK	Trunk unlocks	None, proceed to Operation 10
	Trunk does not unlock	If the doors unlock, repair/replace the Trunk Lock Motor circuit or Trunk Lock Motor. If the doors do not unlock, repair/replace the Trunk Switch. Repair/replace the Central Locking Control Unit if the Trunk Switch Circuit is OK
10. Turn the key back to LOCK	Gas Filler locks	None, proceed to Operation 11
	Gas Filler does not lock	Repair/replace the Gas Filler Lock Motor circuit
11. Turn the key to UNLOCK	Gas Filler unlocks	None
	Gas Filler does not unlock	Repair/replace the Gas Filler Lock Motor circuit

- If all results are normal, the system is OK.

SYSTEM DIAGNOSIS

- Do the following tests when directed by the System Check Table.

A: CONTROL UNIT LOCK TEST (TABLE 1)

Measure: VOLTAGE At: CONTROL UNIT CONNECTOR (Connected)		
Measure Between	Correct Voltage	For Diagnosis
3 (RD/WT) & Ground	Battery	See 1
3 (RD/WT) & 4 (BR)	Battery	See 2
<ul style="list-style-type: none"> • If the voltages are correct, proceed to Table 2. <ol style="list-style-type: none"> 1. Check the RD/WT wire for an open. 2. Check the BR wire for an open to ground (see schematic). 		

A: CONTROL UNIT LOCK TEST (TABLE 2)

Connect: A FUSED JUMPER At: CONTROL UNIT CONNECTOR (Connected)		
Jumper Between	Correct Result	For Diagnosis
7 (YL/BU) & Ground	Doors lock	See 1
<ul style="list-style-type: none"> • If the result is correct, repair/replace the switches and related wiring (see schematic). <ol style="list-style-type: none"> 1. Proceed to Table 3. 		

**A: CONTROL UNIT LOCK TEST
(TABLE 3)**

Connect: FUSED JUMPER		
At: CONTROL UNIT CONNECTOR (Disconnected)		
Jumper Between	Correct Result	For Diagnosis
1 (BU) & 3 (RD/WT) 2 (WT) & 4 (BR)	Doors lock	See 1
<ul style="list-style-type: none"> If the result is correct, replace the Central Locking Control Unit. <ol style="list-style-type: none"> Check the BU wire to splice S405 and the WT wire to splice S406 for opens (see schematic). 		

**B: UNLOCK INHIBIT TEST
(TABLE 2)**

Measure: RESISTANCE		
At: ALL FRONT DOOR LOCK MOTOR (Disconnected)		
Measure Between	Correct Resistance	For Diagnosis
Terminal 6 and Terminal 5	1 K ohm	See 1
<ul style="list-style-type: none"> If the resistance is correct, replace the Unlock Inhibit Switch. <ol style="list-style-type: none"> Replace RH Front Door Lock Motor. 		

C: CONTROL UNIT UNLOCK TEST

Connect: A FUSED JUMPER		
At: CONTROL UNIT CONNECTOR (Connected)		
Jumper Between	Correct Result	For Diagnosis
6 (GN/BU) & Ground	Doors unlock	See 1
<ul style="list-style-type: none"> If the result is correct, repair/replace the switches and related wiring (see schematic). <ol style="list-style-type: none"> Replace the Central Locking Control Unit. 		

**B: UNLOCK INHIBIT TEST
(TABLE 1)**

Measure: RESISTANCE		
At: CONTROL UNIT CONNECTOR (Disconnected)		
Conditions		
<ul style="list-style-type: none"> Driver's Door Lock: UNLOCK INHIBIT 		
Measure Between	Correct Resistance	For Diagnosis
10 (RD/BR) & Ground	1 K ohm	See 1
<ul style="list-style-type: none"> If the resistance is correct but the unlock inhibit only operates on the Driver's Lock, replace the Central Locking Control Unit. <ol style="list-style-type: none"> Check for opens in the WT/BK, BK/WT and BR wires. If OK, proceed to Table 2. 		

CIRCUIT DESCRIPTION

The Central Locking System is controlled by the Central Locking Control Unit. This unit senses when a lock switch is moved by a key, and sends the appropriate signal to drive the Motors. The Central Lock Control Unit controls the Door Locks, Gas Filler Lock and Trunk Lock. The unit also has an Inertia Switch which closes on impact greater than 5g. If in RUN or START the locks are then unlocked.

Lock

When the Key is inserted into a lock and turned clockwise, the Lock switch moves to LOCK and grounds terminal 7 of the Central Locking Control Unit. The unit activates the Lock Relay and applies voltage from Fuse 5 to the Lock Motor, which is grounded through the WT wire, Central Locking Control Unit and BR wire. The Lock Motor then pulls the lock down. As the motor runs, a switch is gradually moved from terminal 2 to terminal 6 of all but the Driver's Lock Motor. At terminal 6, the switch position prevents voltage from being applied to the motor. The door locks also control the Trunk Lock and Gas Filler Lock.

Unlock

When the key is turned counterclockwise, terminal G of the Central Locking Control Unit is grounded through the Lock Switch. The Central Locking Control Unit then activates the Unlock Relay and applies voltage from Fuse 27, through the WT wire to the Lock Motor. The motor is grounded through the BU wire, Central Locking Control Unit, and BR wire. The polarity is reversed and the motor pushes the lock up. As the motor runs, the switch is returned to terminal 2.

Unlock Inhibit

When the key is inserted into the Driver's Lock and turned clockwise past the LOCK position, the Unlock inhibit mechanism is engaged. This mechanically inserts a bar into the driver's lock and prevents unlocking through use of the Safety Catch Button. When in the Unlock Inhibit position, the Central Locking Unit is grounded at terminal 10. The unit then activates the Lock Relay, and voltage is applied to the motors through the Unlock Inhibit Switch and BK/WT wires. The motors are again activated and engage their Unlock Inhibit mechanisms.

Trunk Lock

The Trunk Lock operates in a manner similar to the Door Locks.

EARLY PRODUCTION

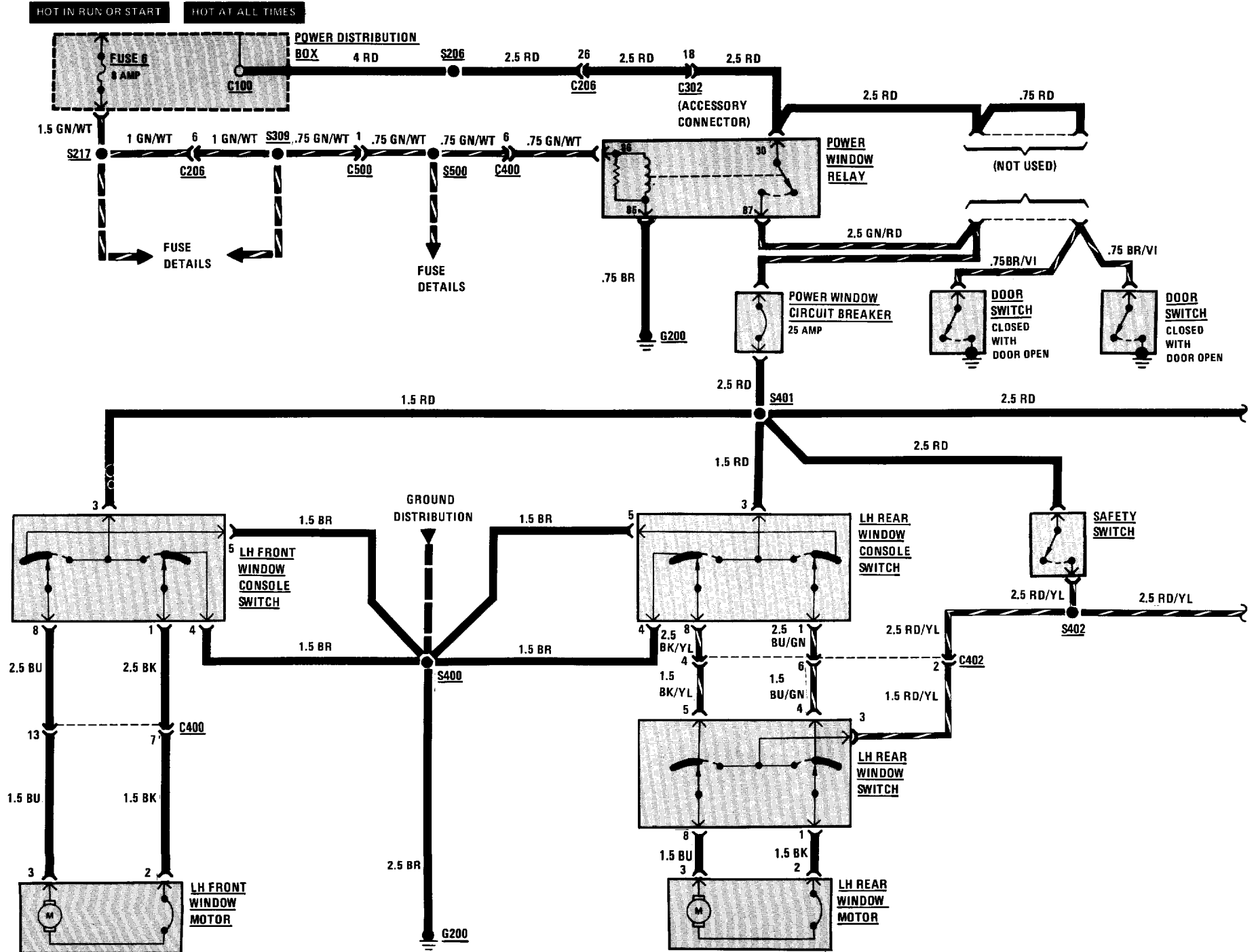

EARLY PRODUCTION

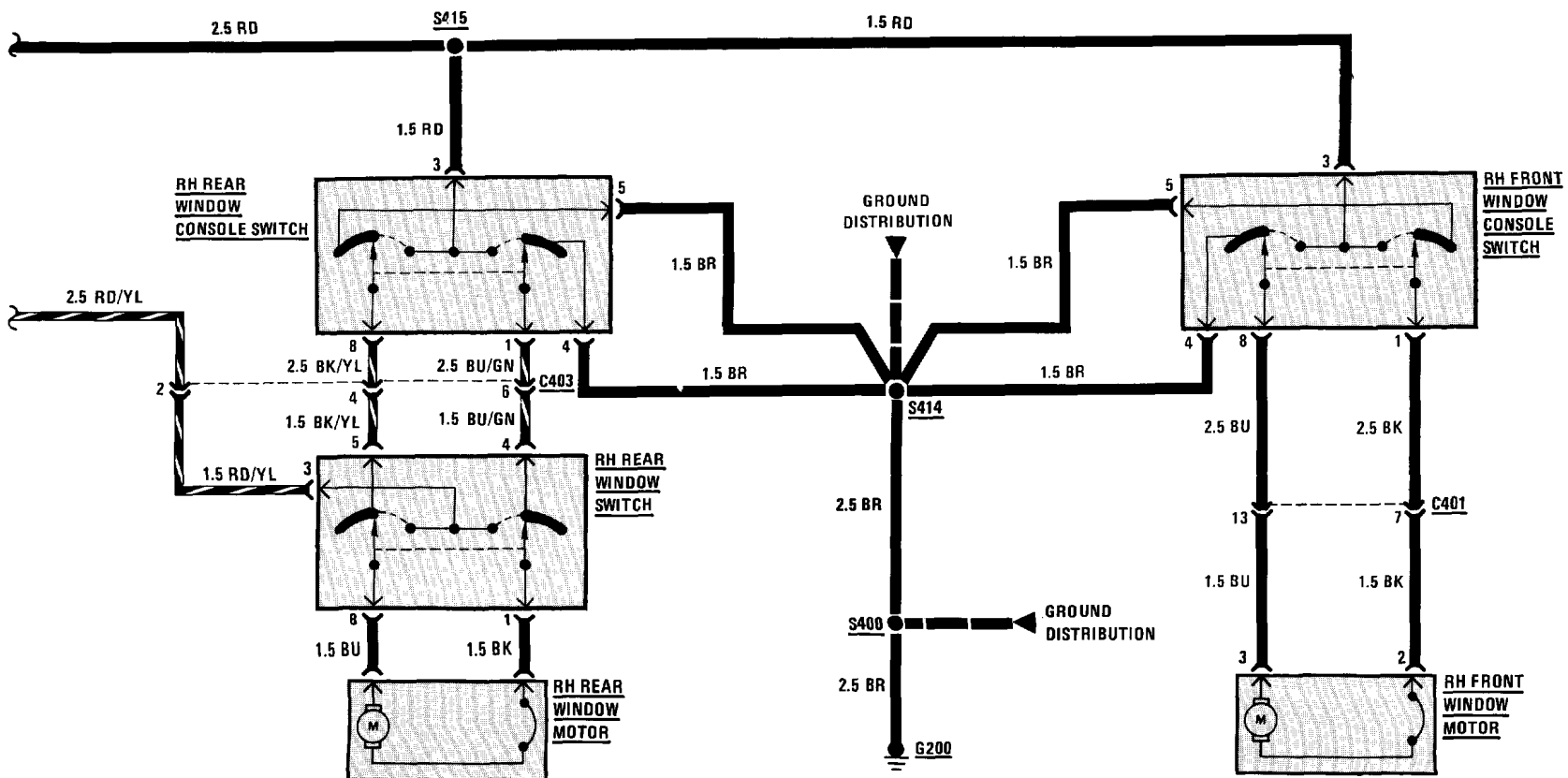

LATE PRODUCTION

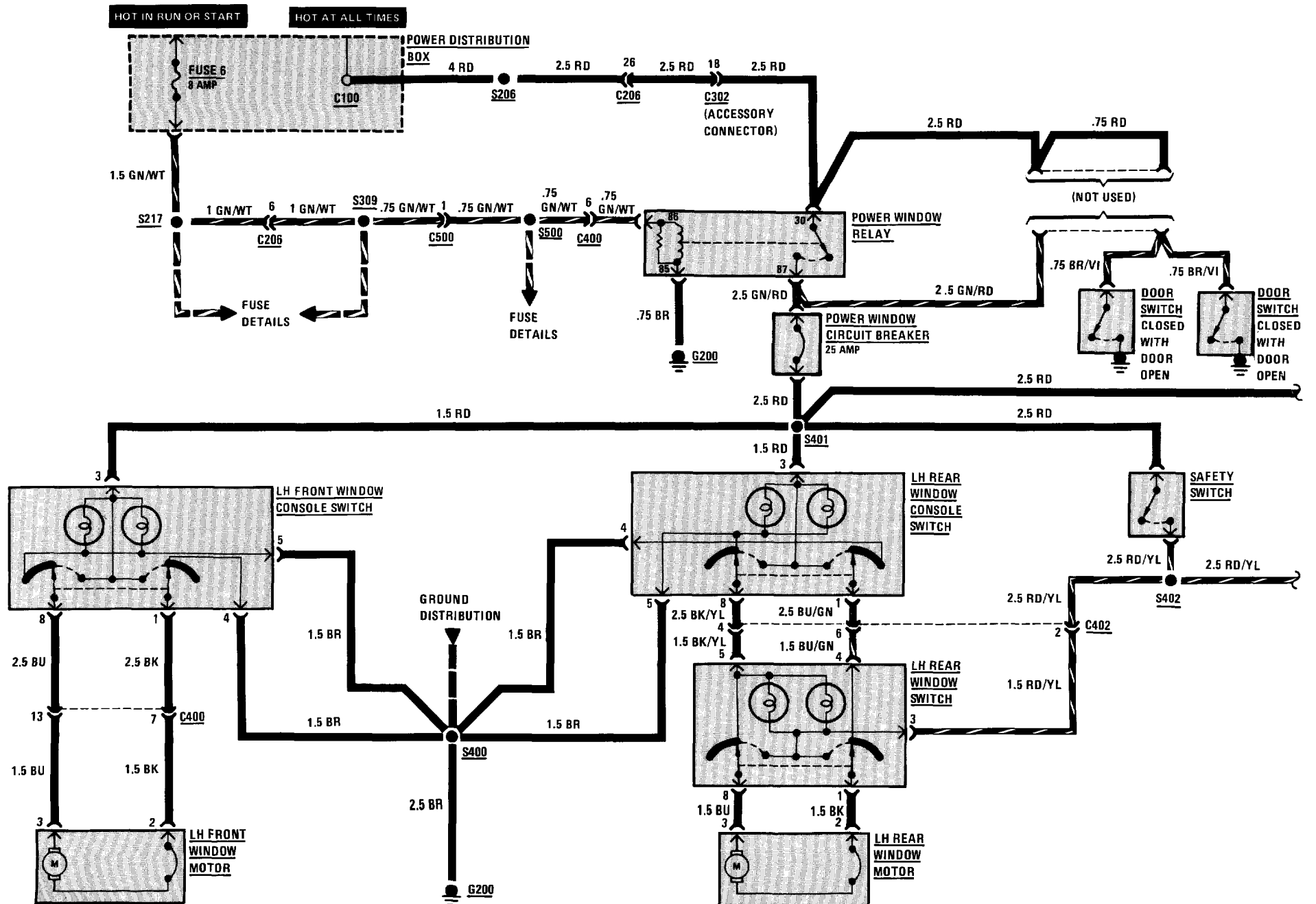

LATE PRODUCTION

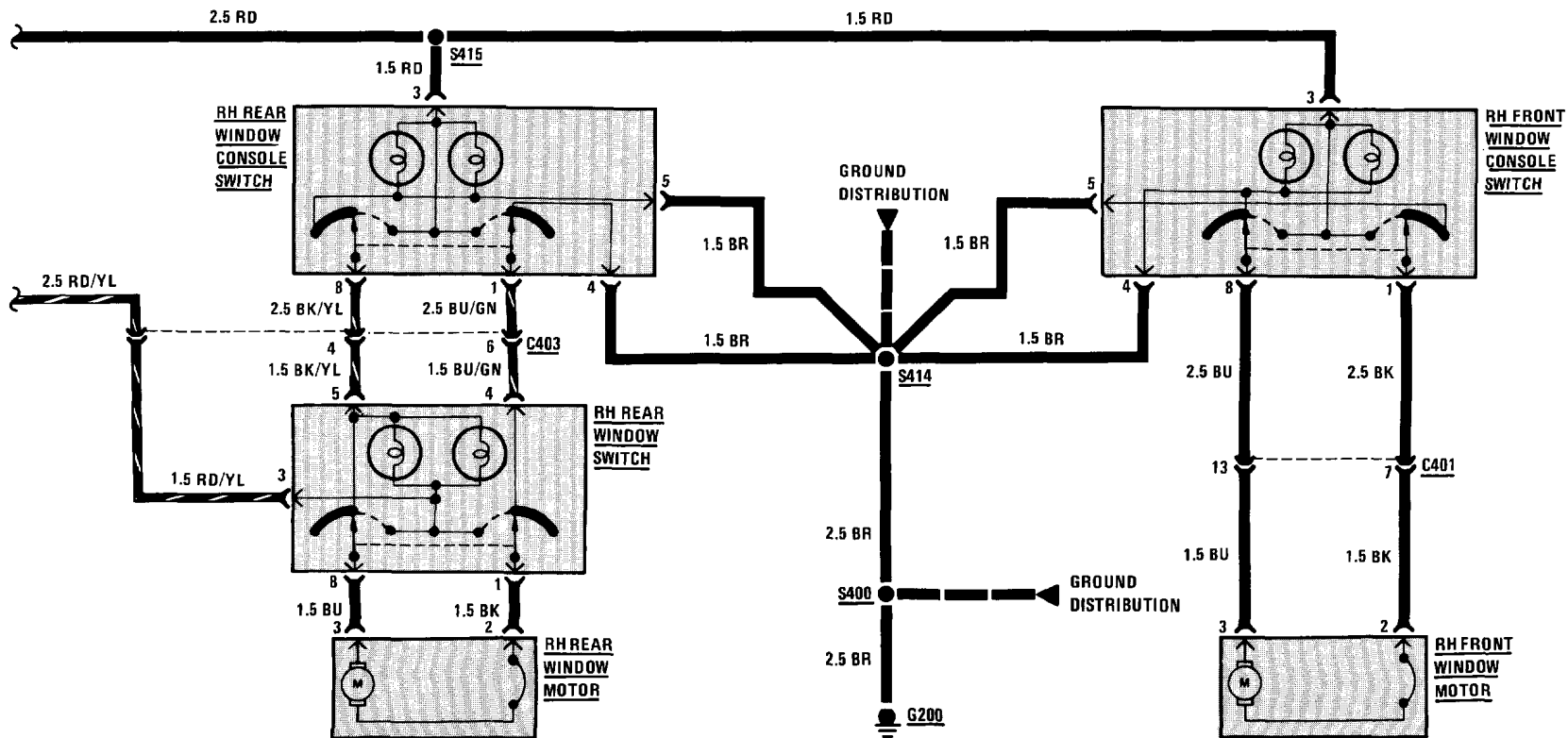

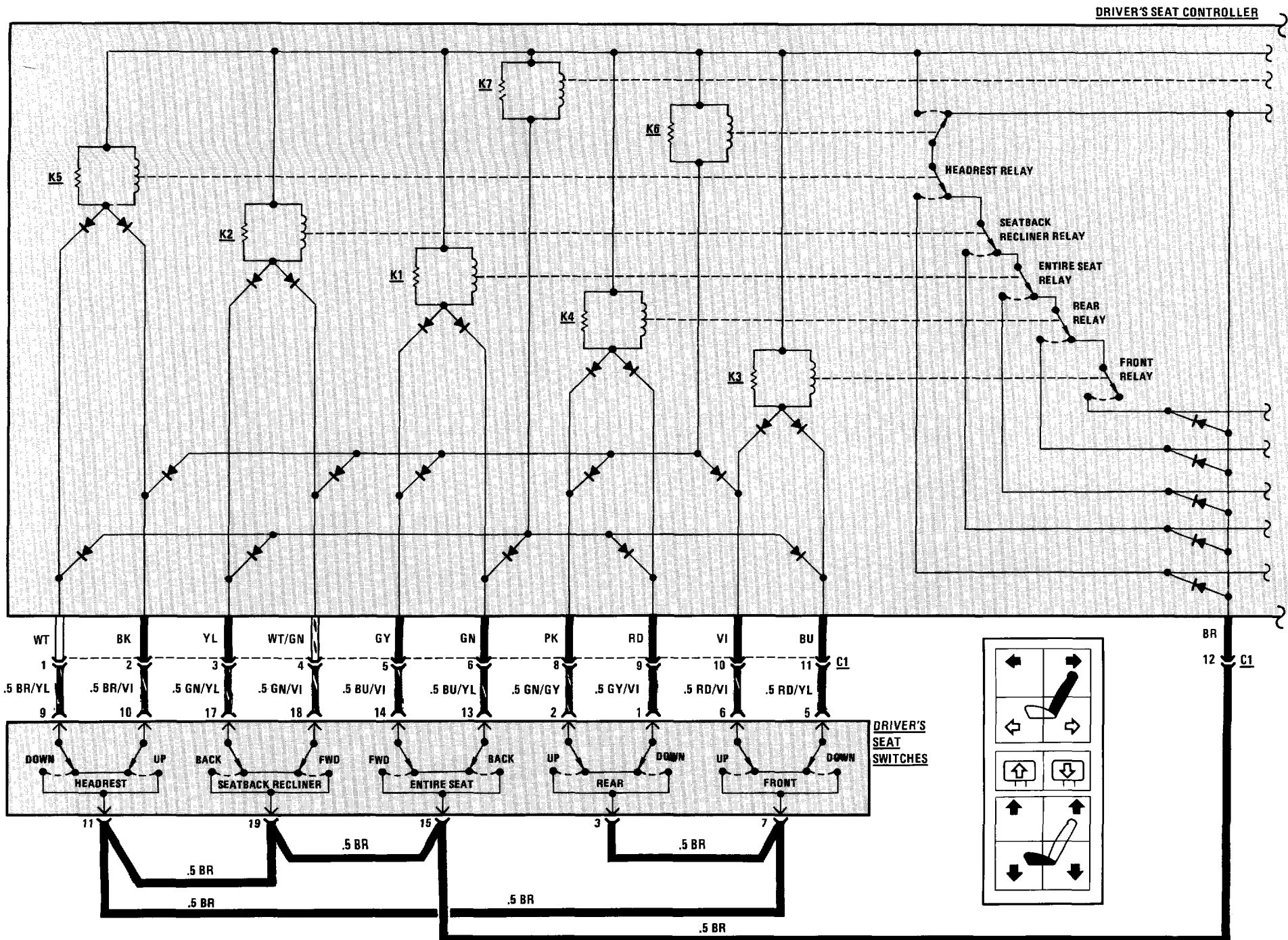

LATE PRODUCTION

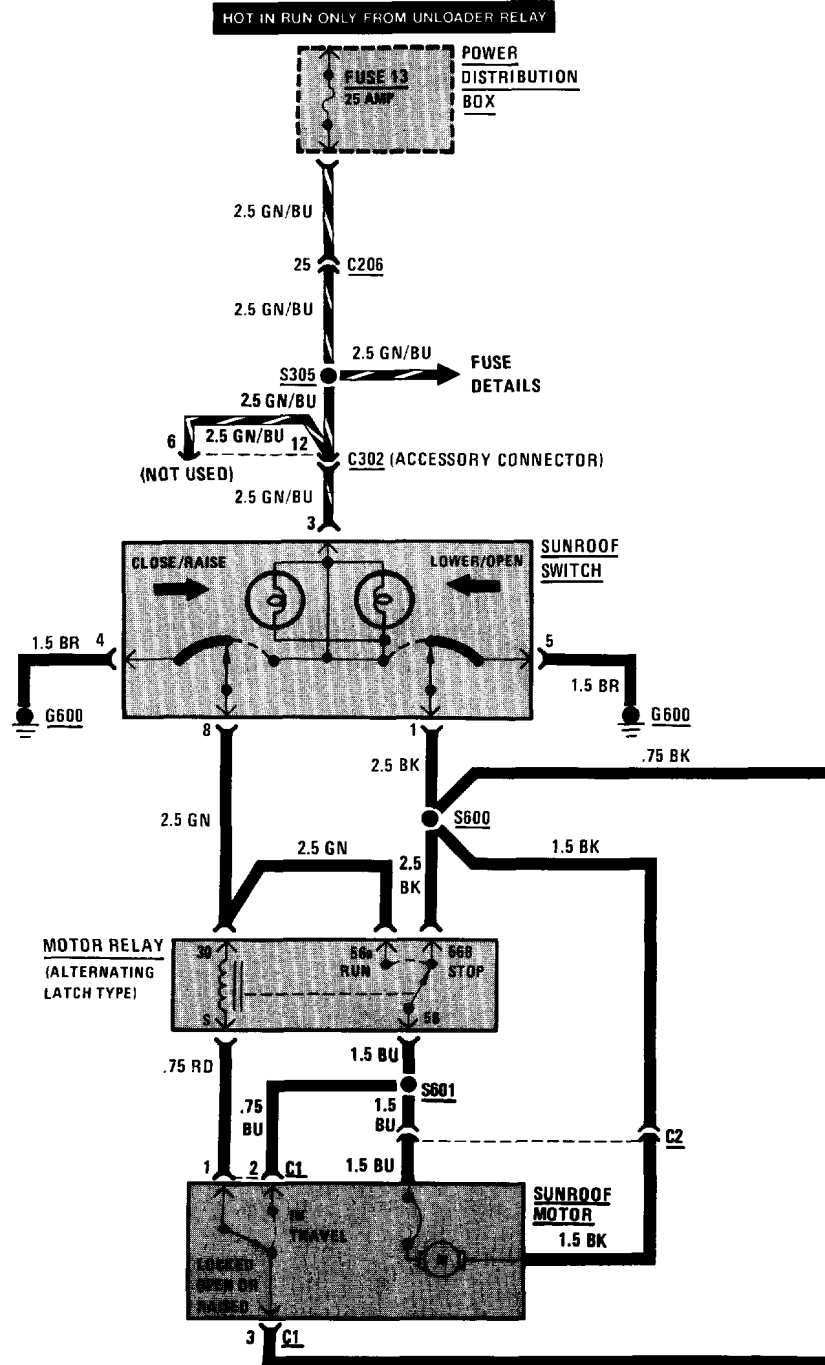

HORN

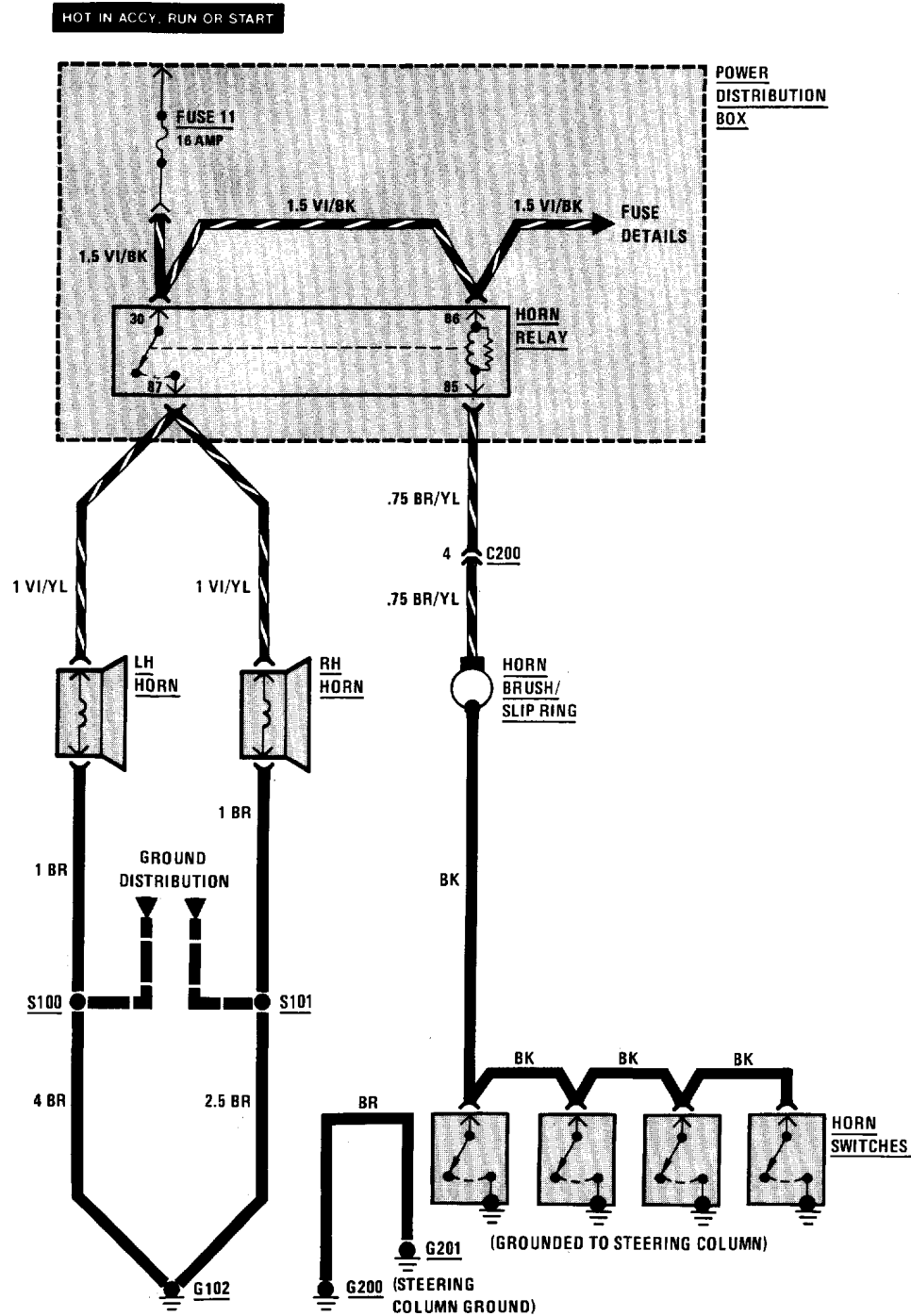

REAR DEFOGGER

HOT IN RUN ONLY FROM UNLOADER RELAY

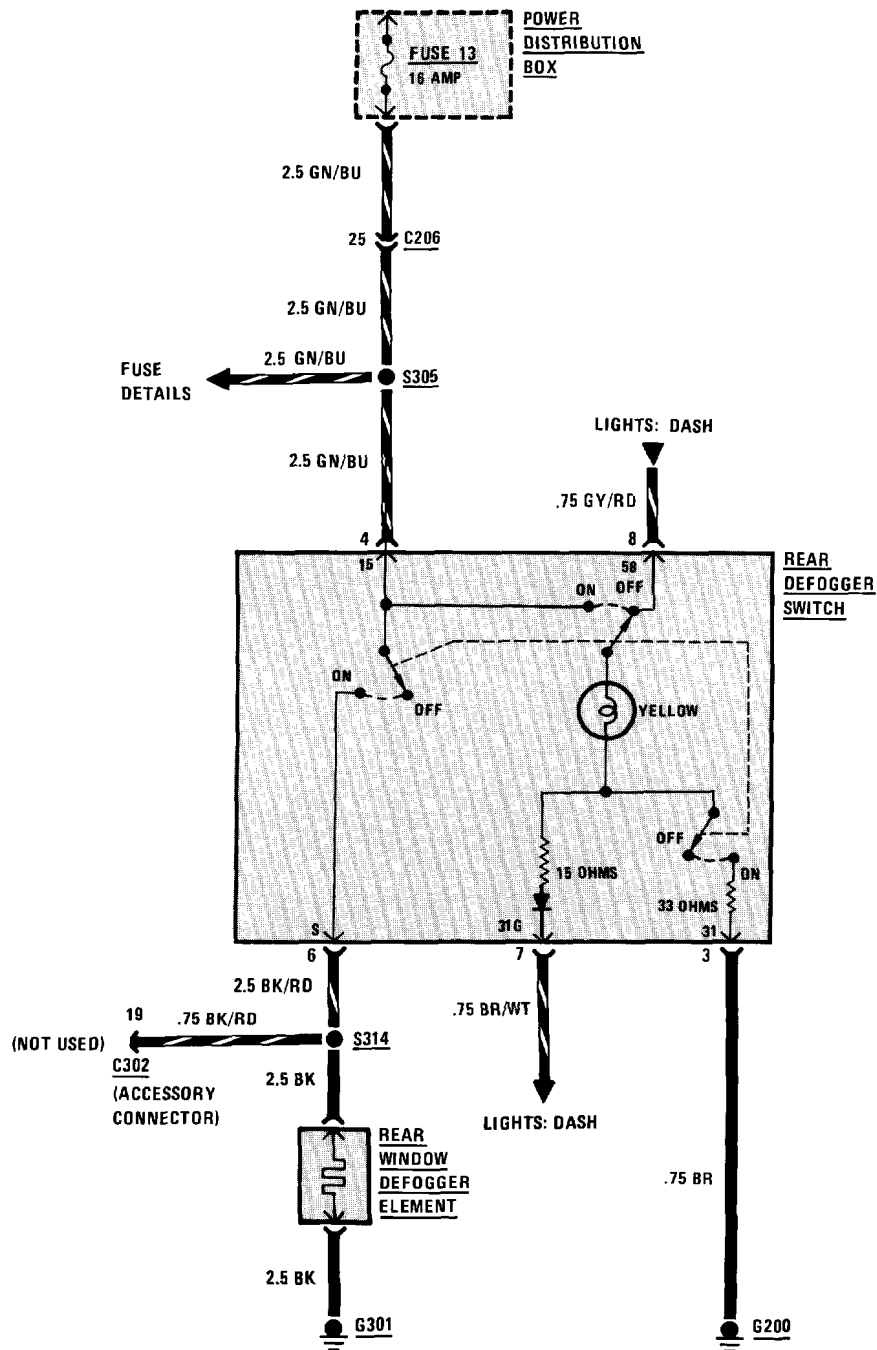

HEATED DOOR LOCKS

HOT AT ALL TIMES

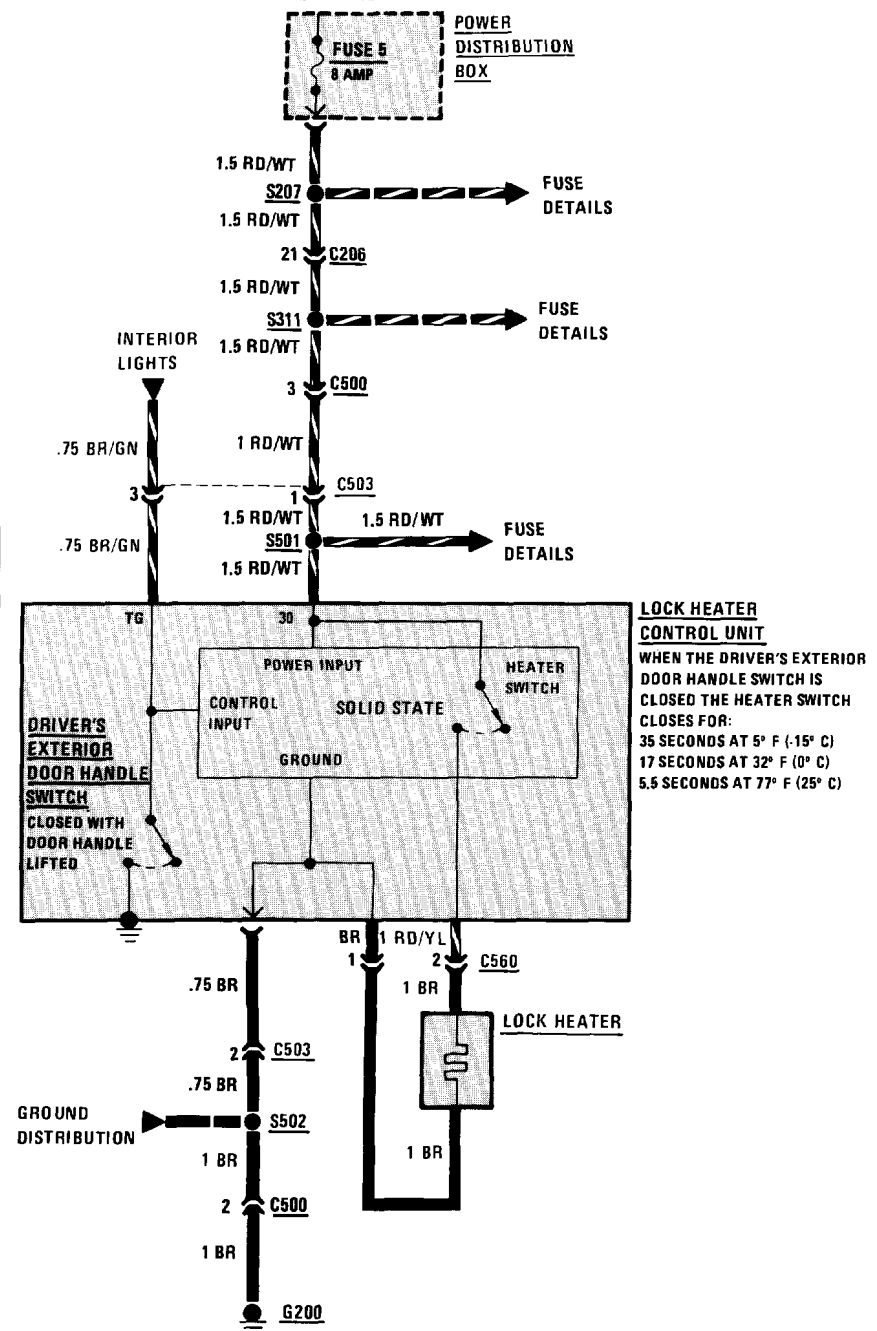

CIGAR LIGHTER/GLOVE BOX LIGHT/AUTO-CHARGING FLASHLIGHT

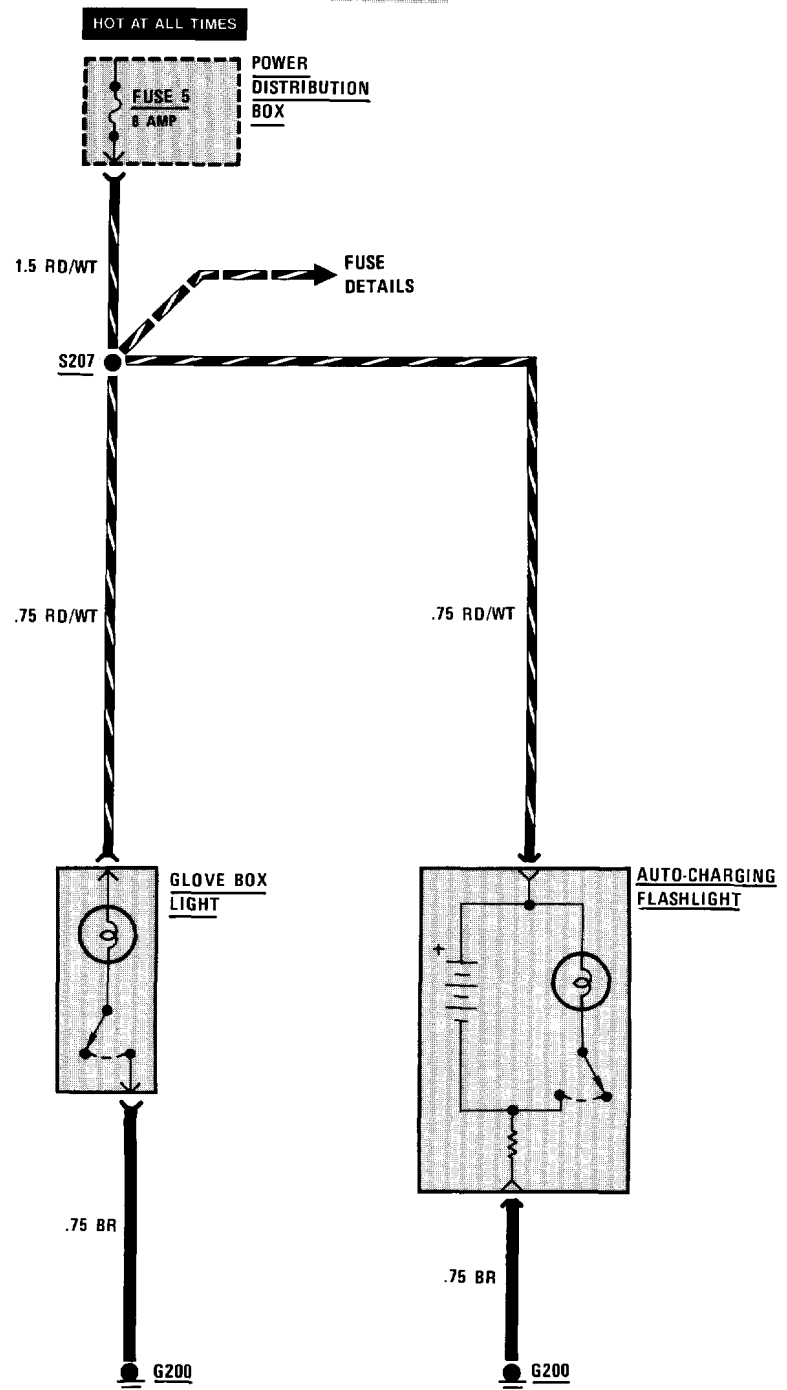
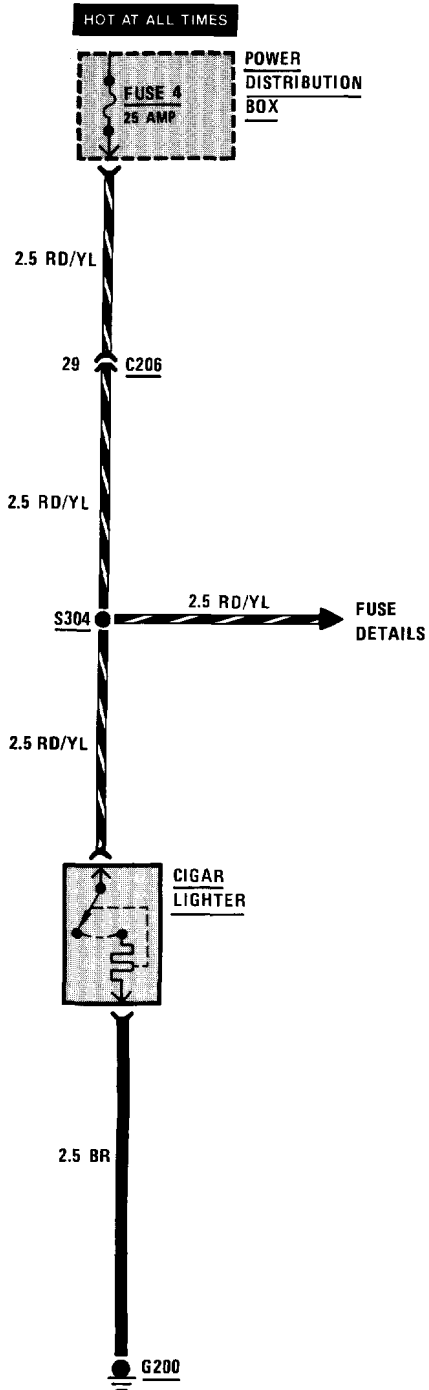

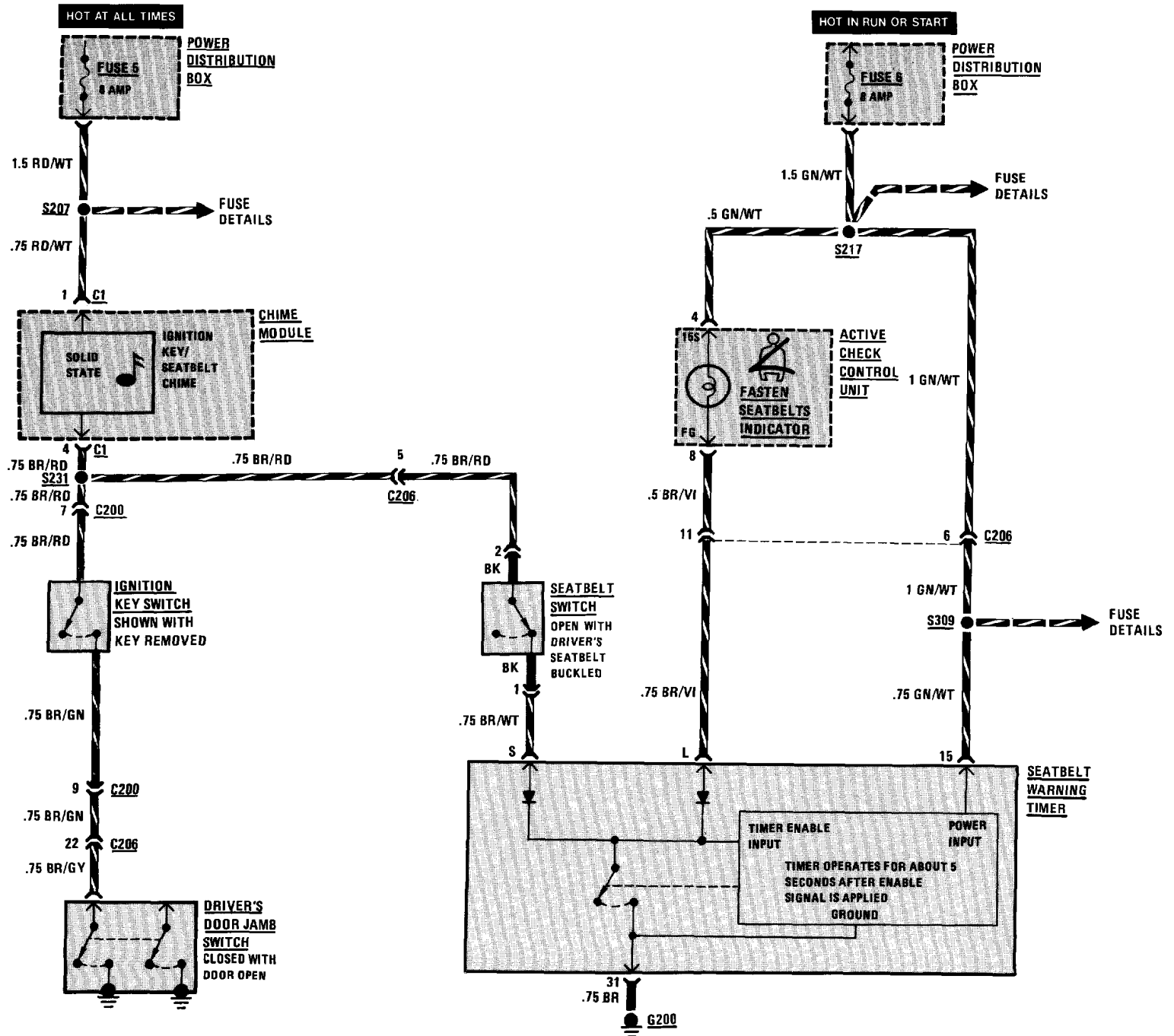

SPEEDOMETER/GAUGES/WARNING INDICATORS EARLY PRODUCTION

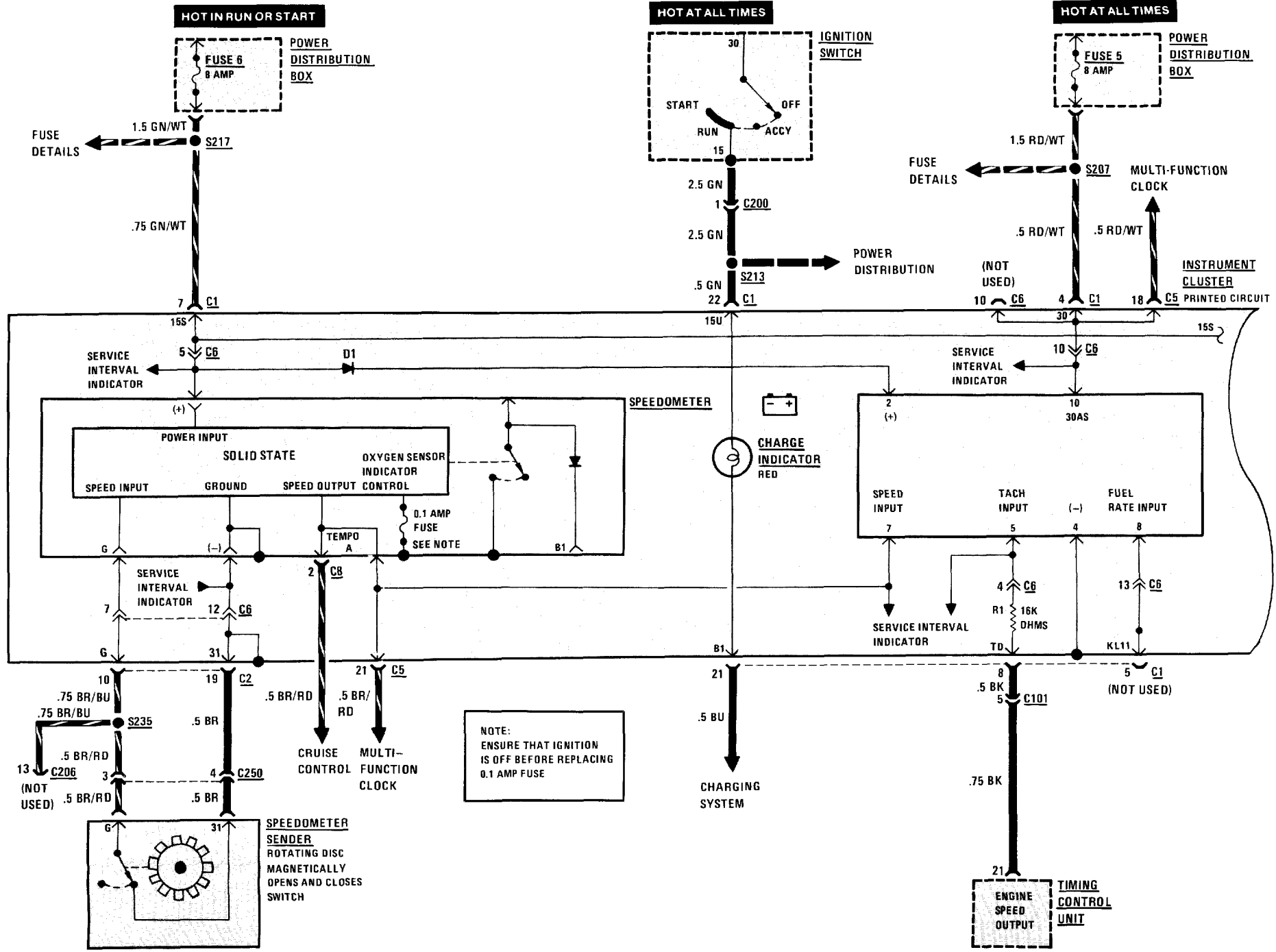

GAUGES/WARNING INDICATORS EARLY PRODUCTION

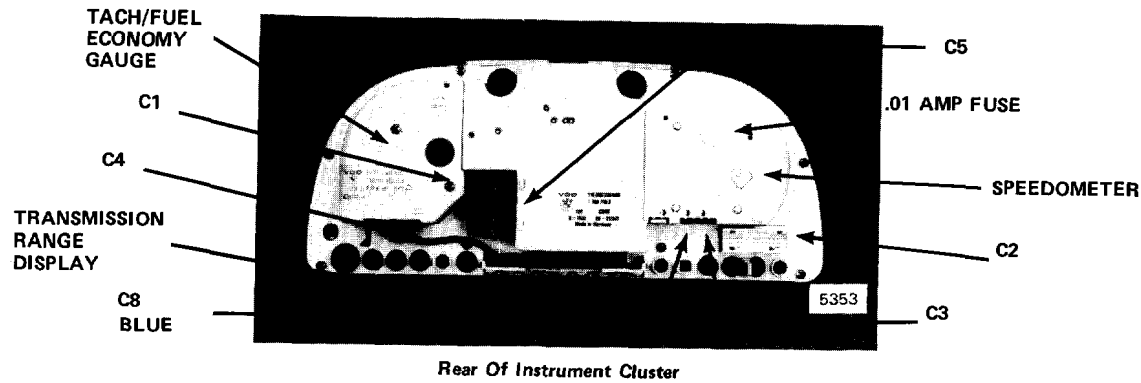

Rear Of Instrument Cluster

INSTRUMENT CLUSTER
PRINTED CIRCUIT

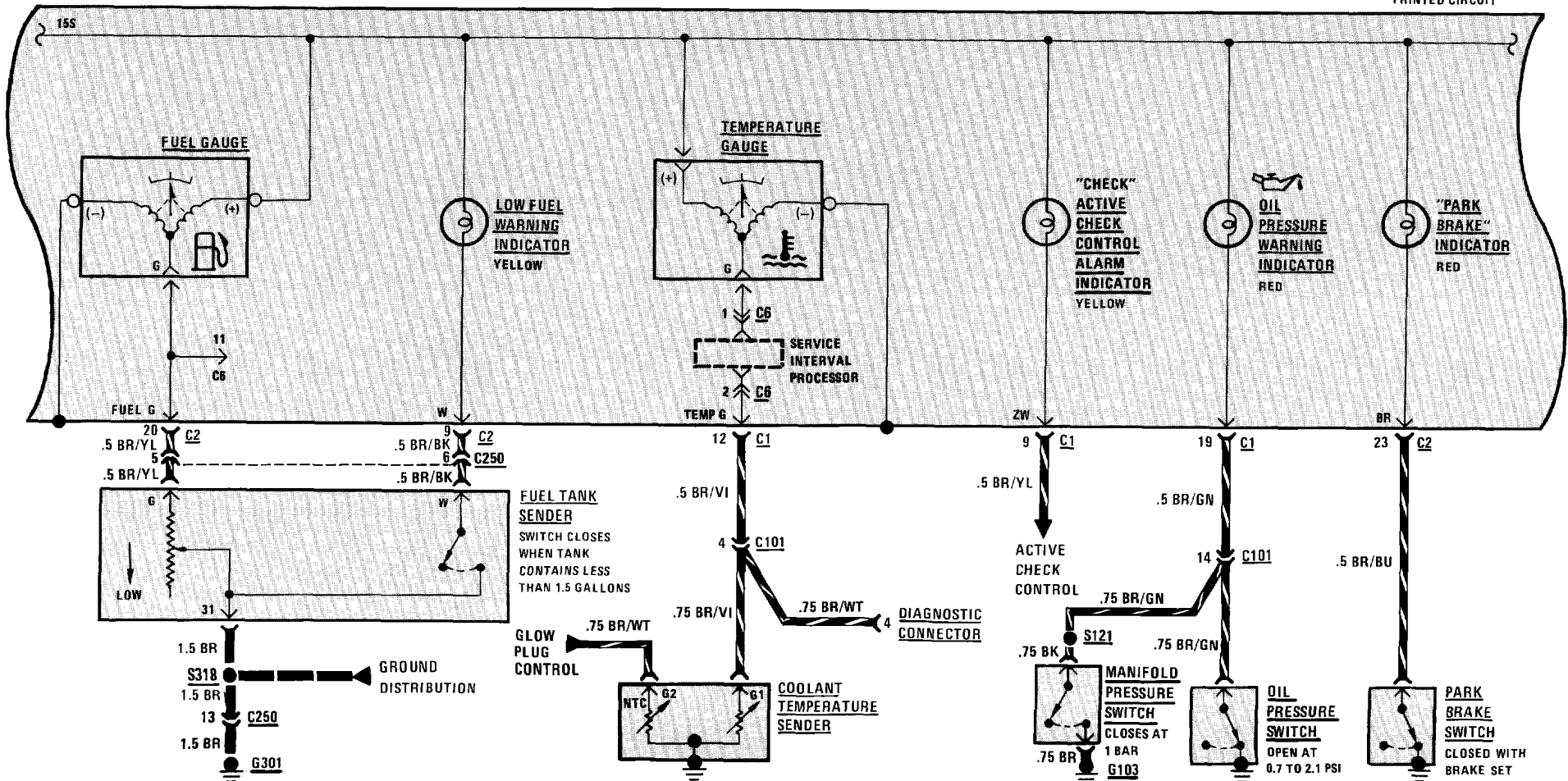

WARNING INDICATORS EARLY PRODUCTION

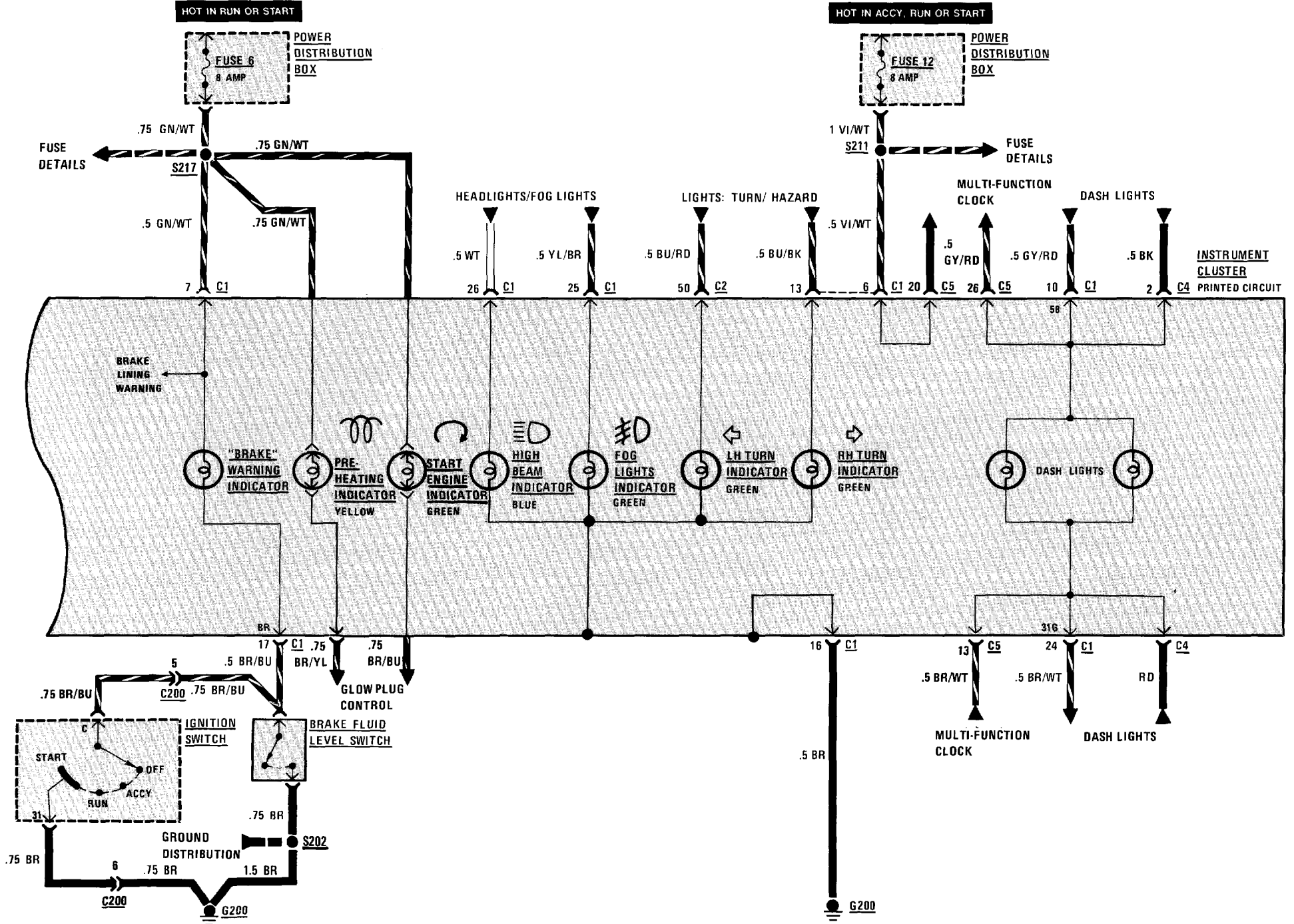

SPEEDOMETER/GAUGES/WARNING INDICATORS LATE PRODUCTION

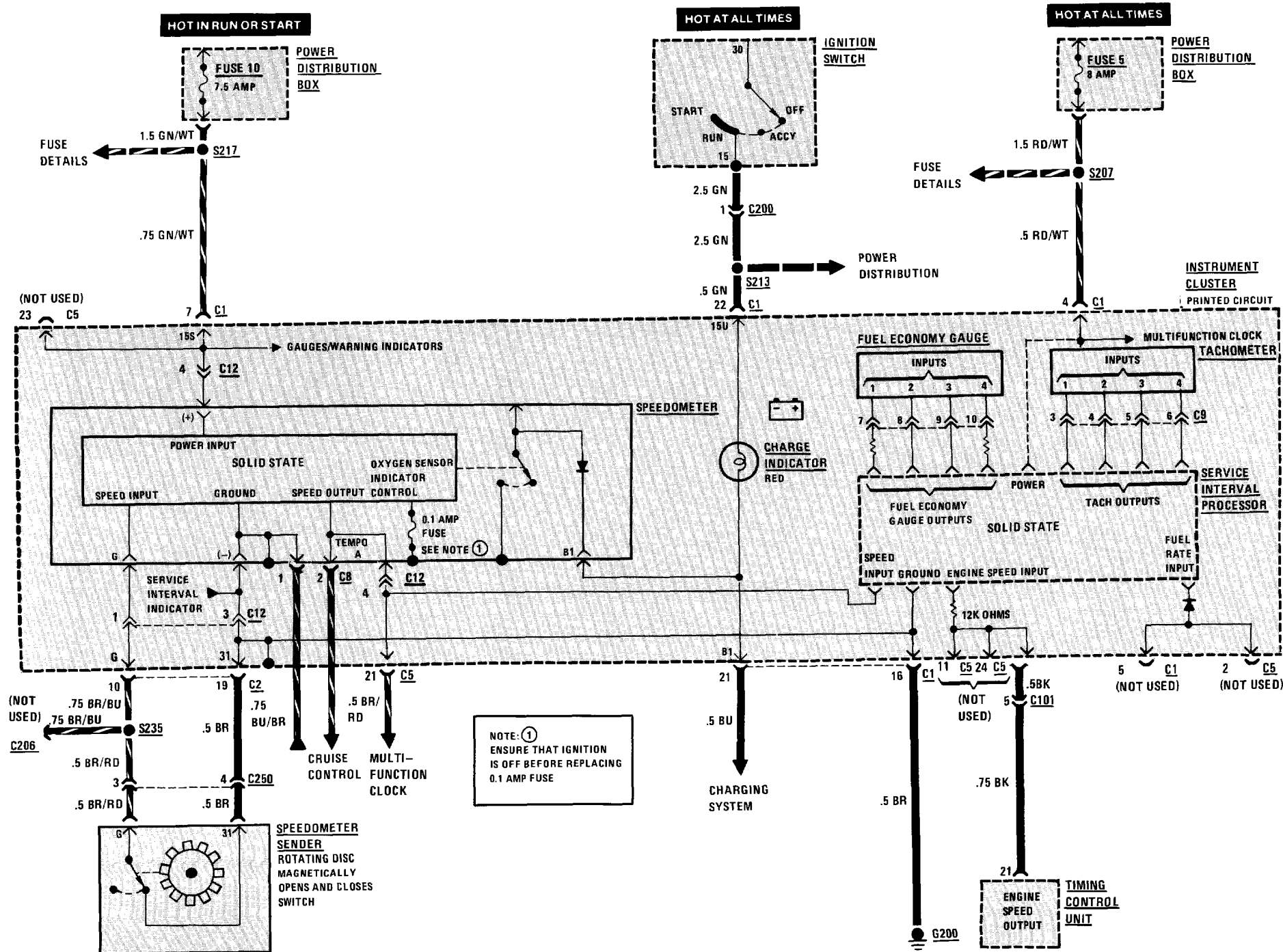

GAUGES/WARNING INDICATORS LATE PRODUCTION

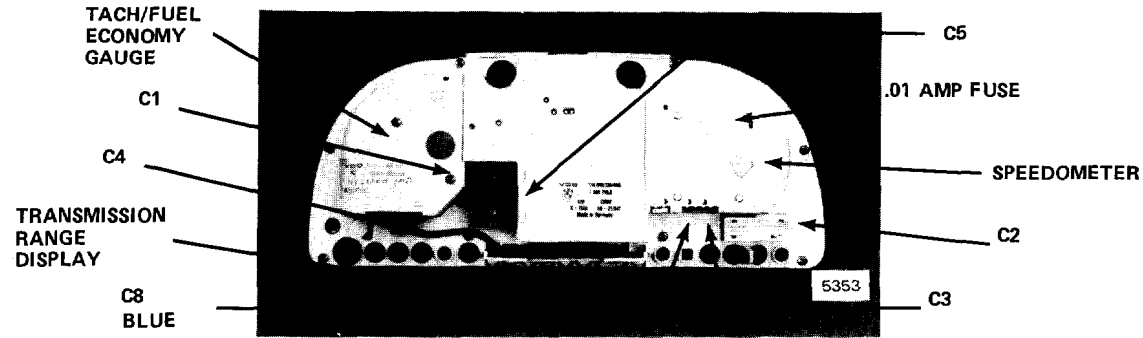

Rear Of Instrument Cluster

INSTRUMENT CLUSTER
PRINTED CIRCUIT

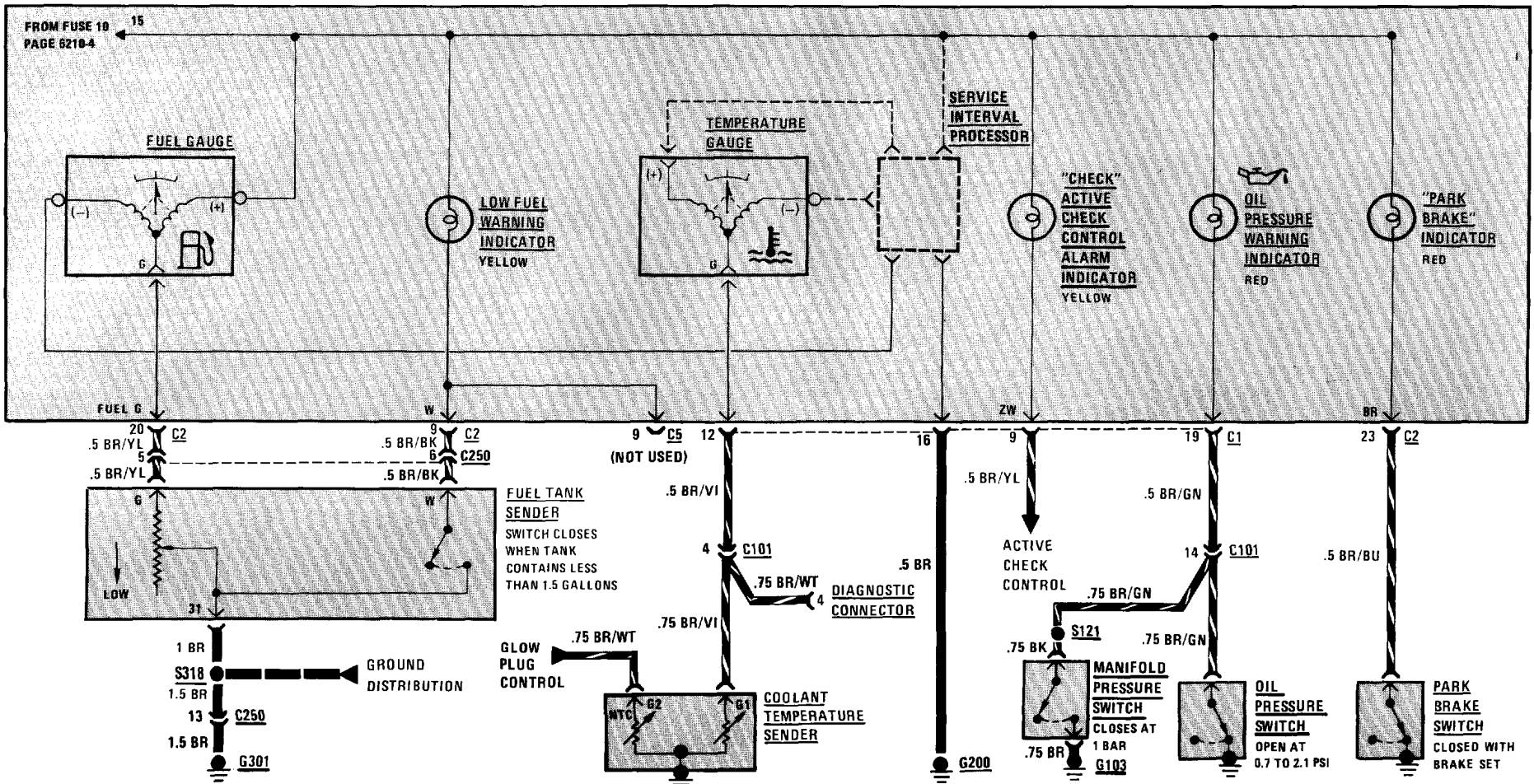

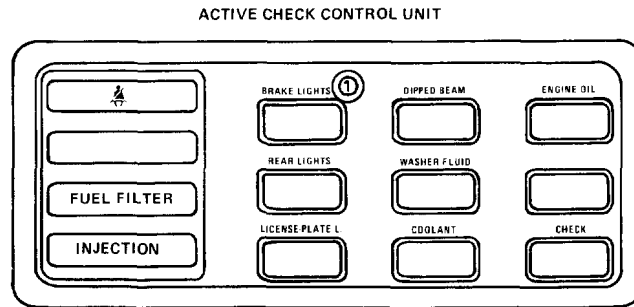
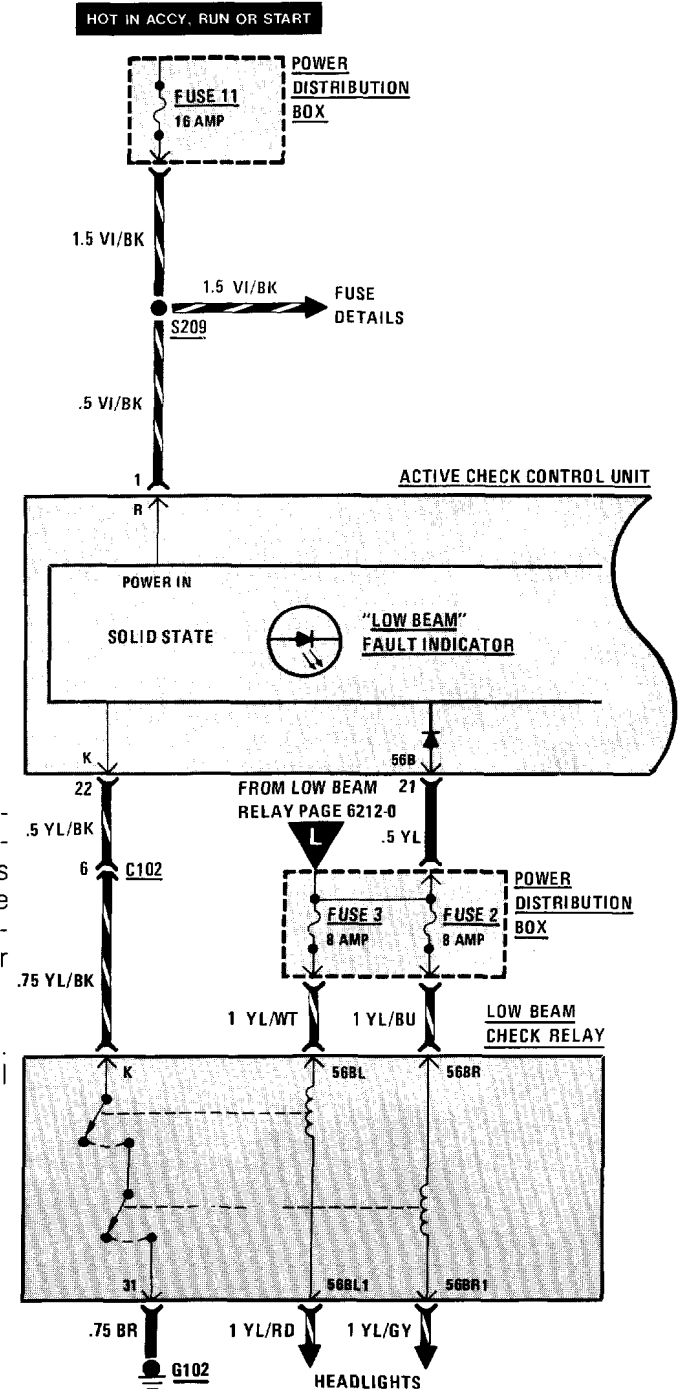
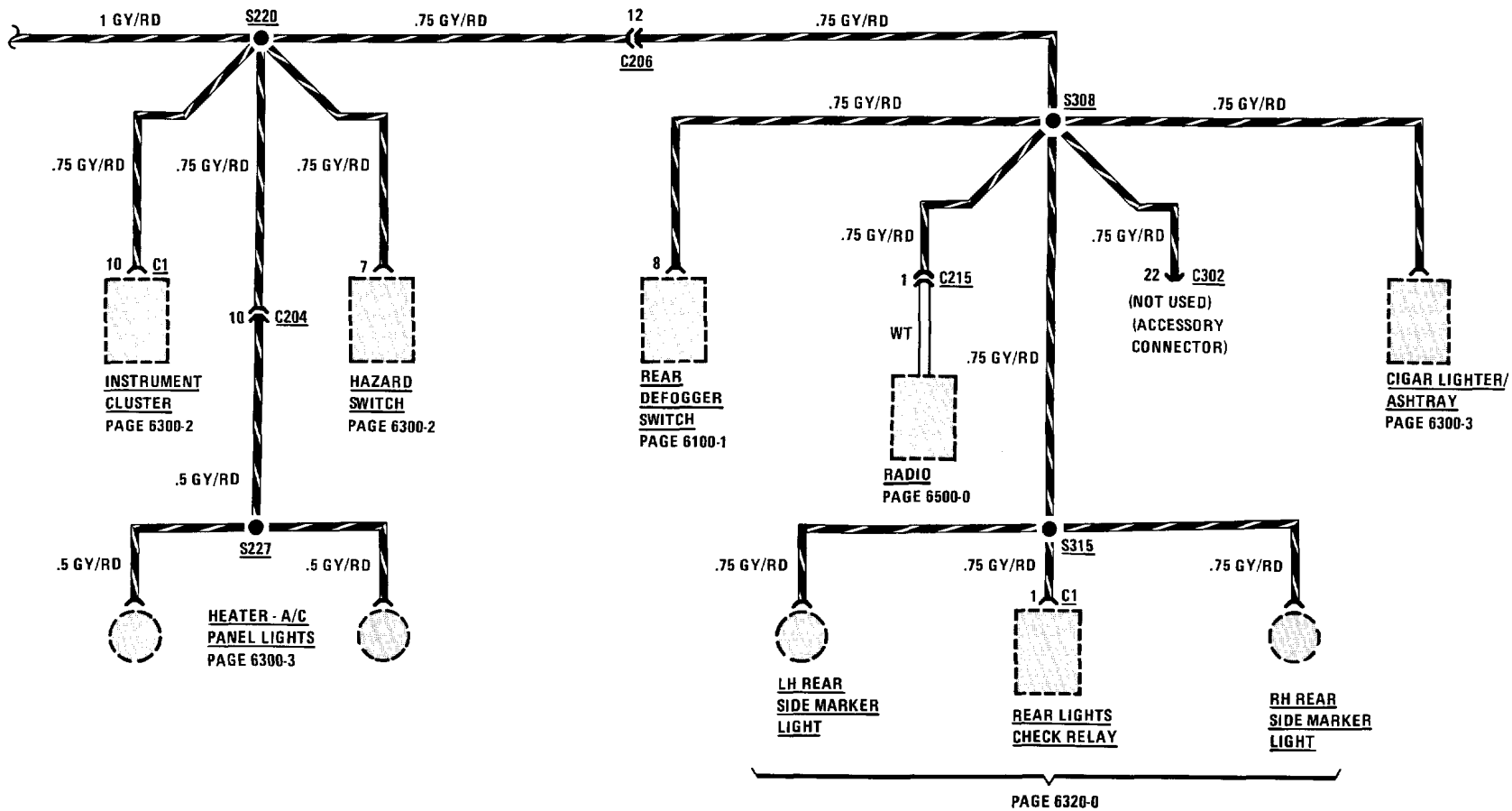

Figure 1 - Above Rear View Mirror

ACTIVE CHECK CONTROL

1. When the Ignition Switch is initially placed in "Run," the Active Check Control Alarm Indicator flashes, and the Active Check Control Unit Brake Light LED and panel light illuminate for test purposes. Depressing the brake pedal clears the display.
2. When the Ignition Switch is placed in "Run," fault monitoring begins. To monitor the low beams, rear lights, or license lights, those circuits must be on. The brake lights are monitored only while the brake pedal is depressed.
3. When a fault occurs, the alarm indicator flashes, the appropriate LED indicator lights, and the panel light goes on for five seconds. Depressing the test button will clear the alarm indicator, but the LED fault indicator remains on.
4. To test the unit, depress the test button. The LED fault indicators and panel light should go on.





LIGHTS: DASH/TRANSMISSION RANGE

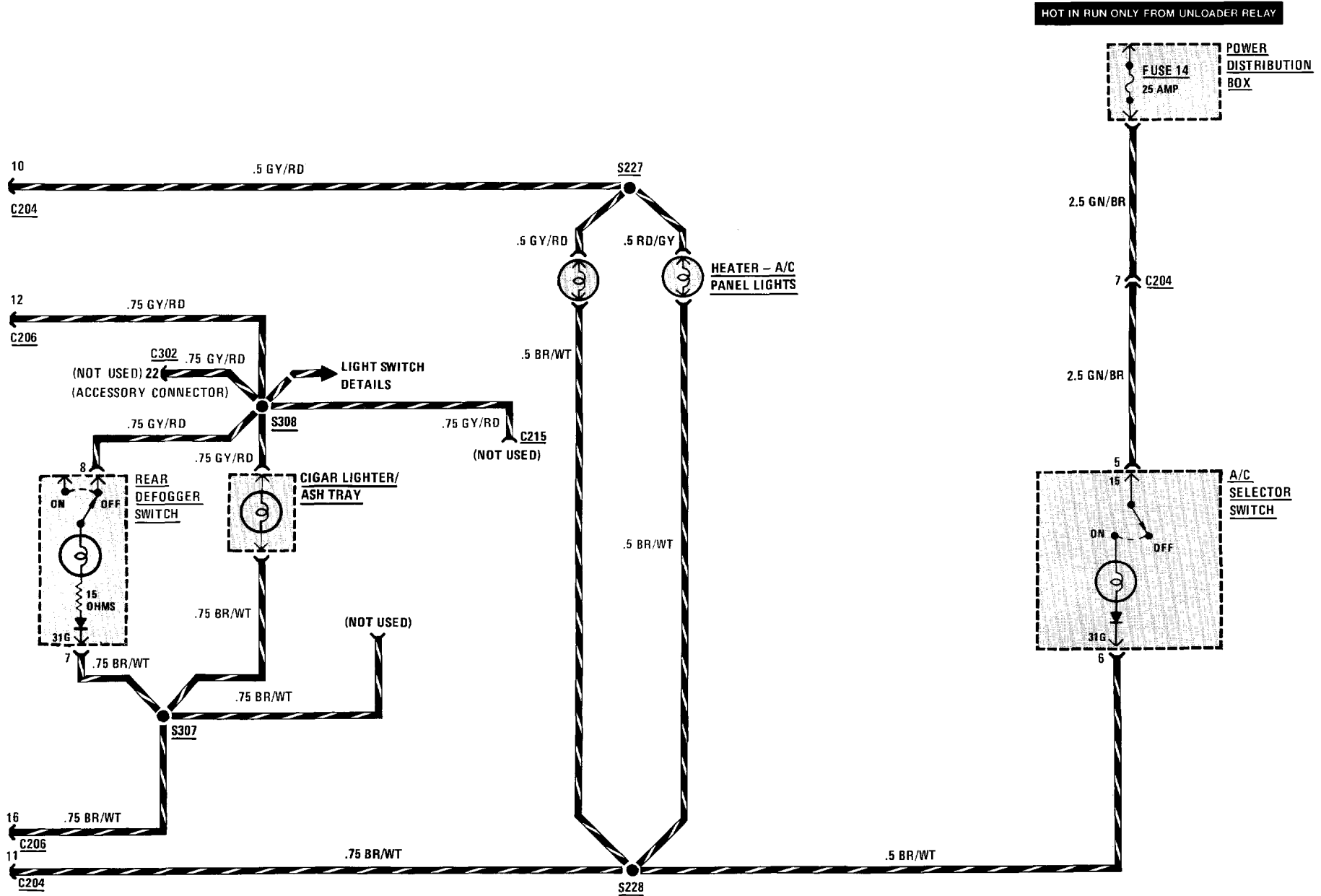

CONTROL

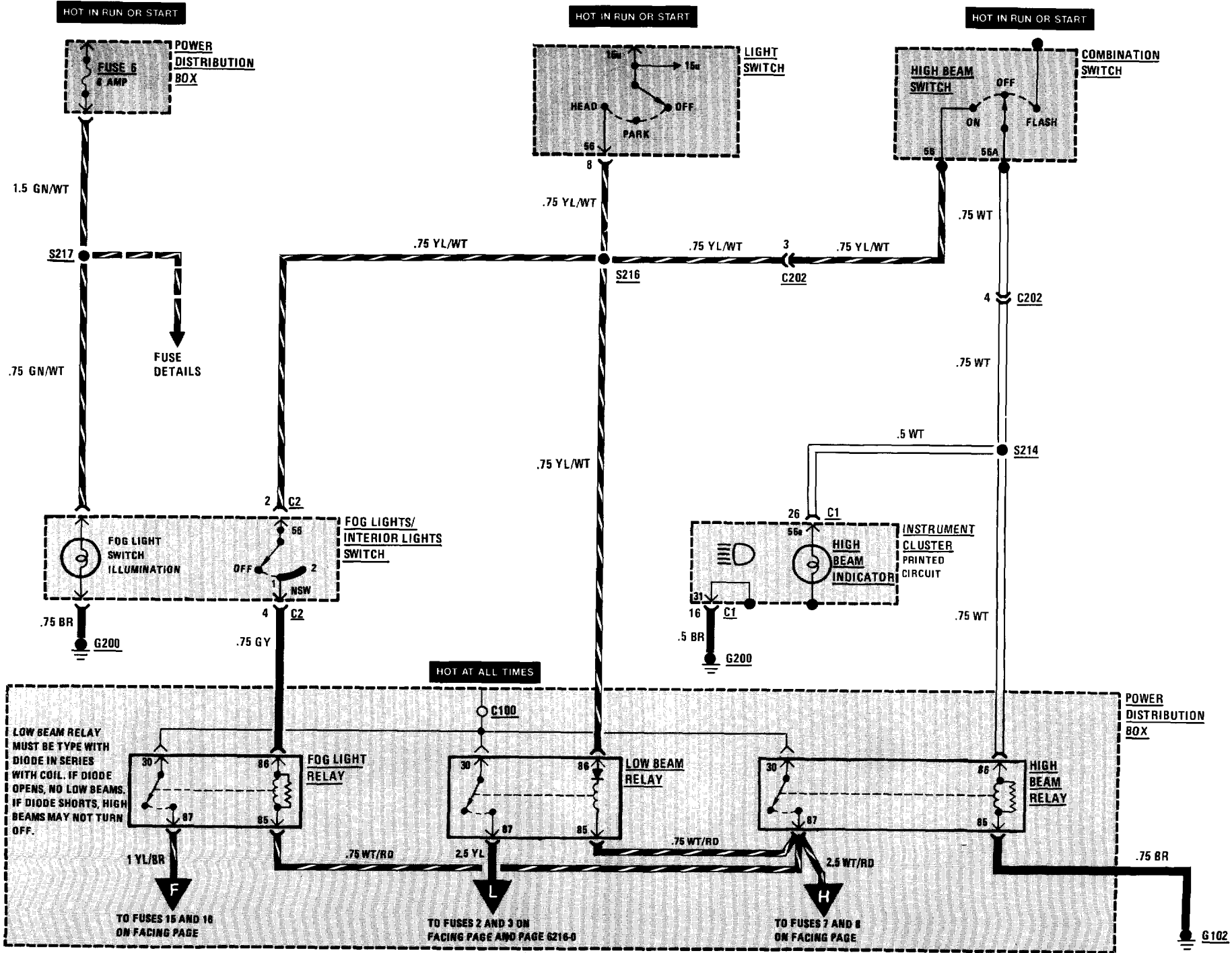

CONTINUED ON PAGE 6312-1

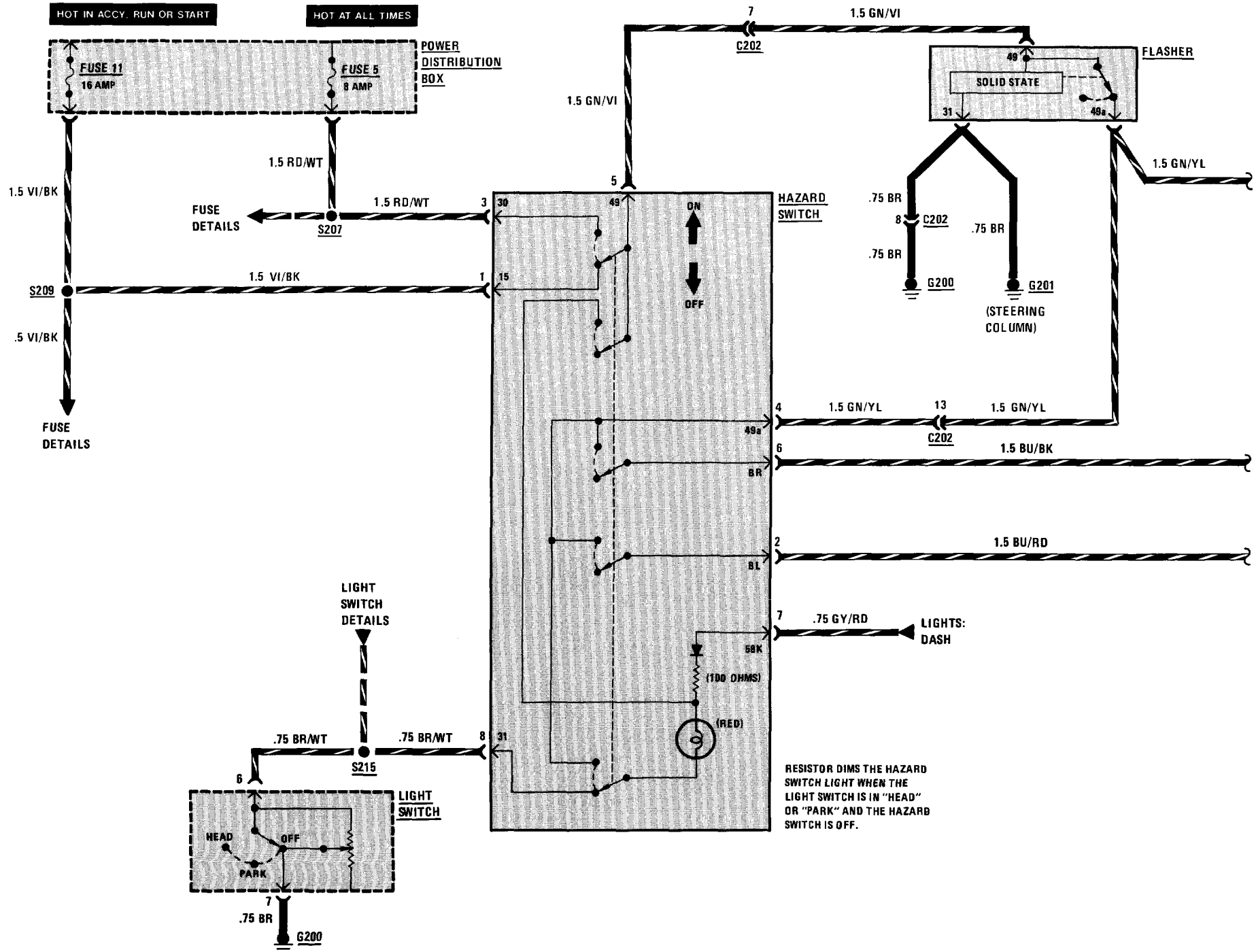

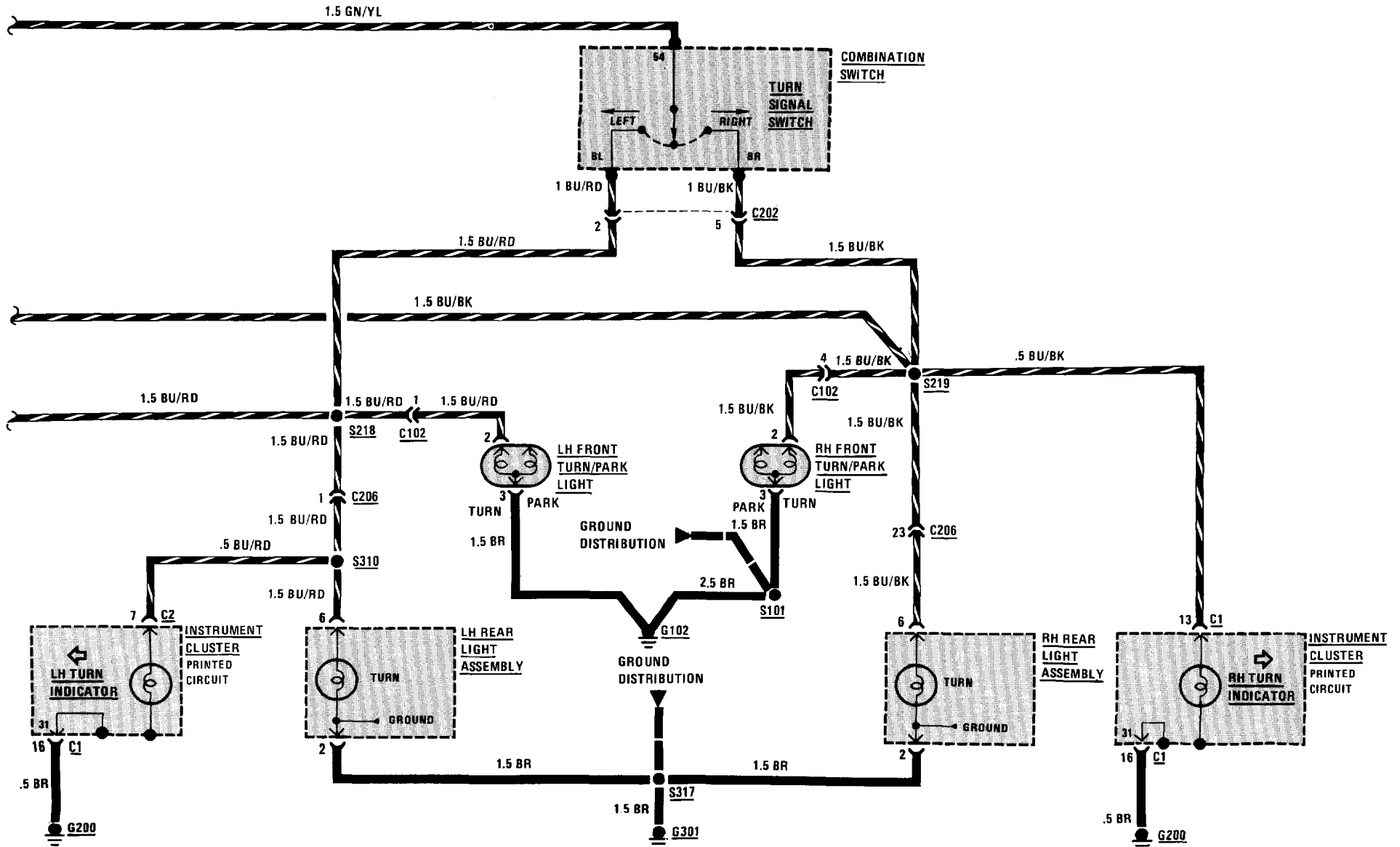

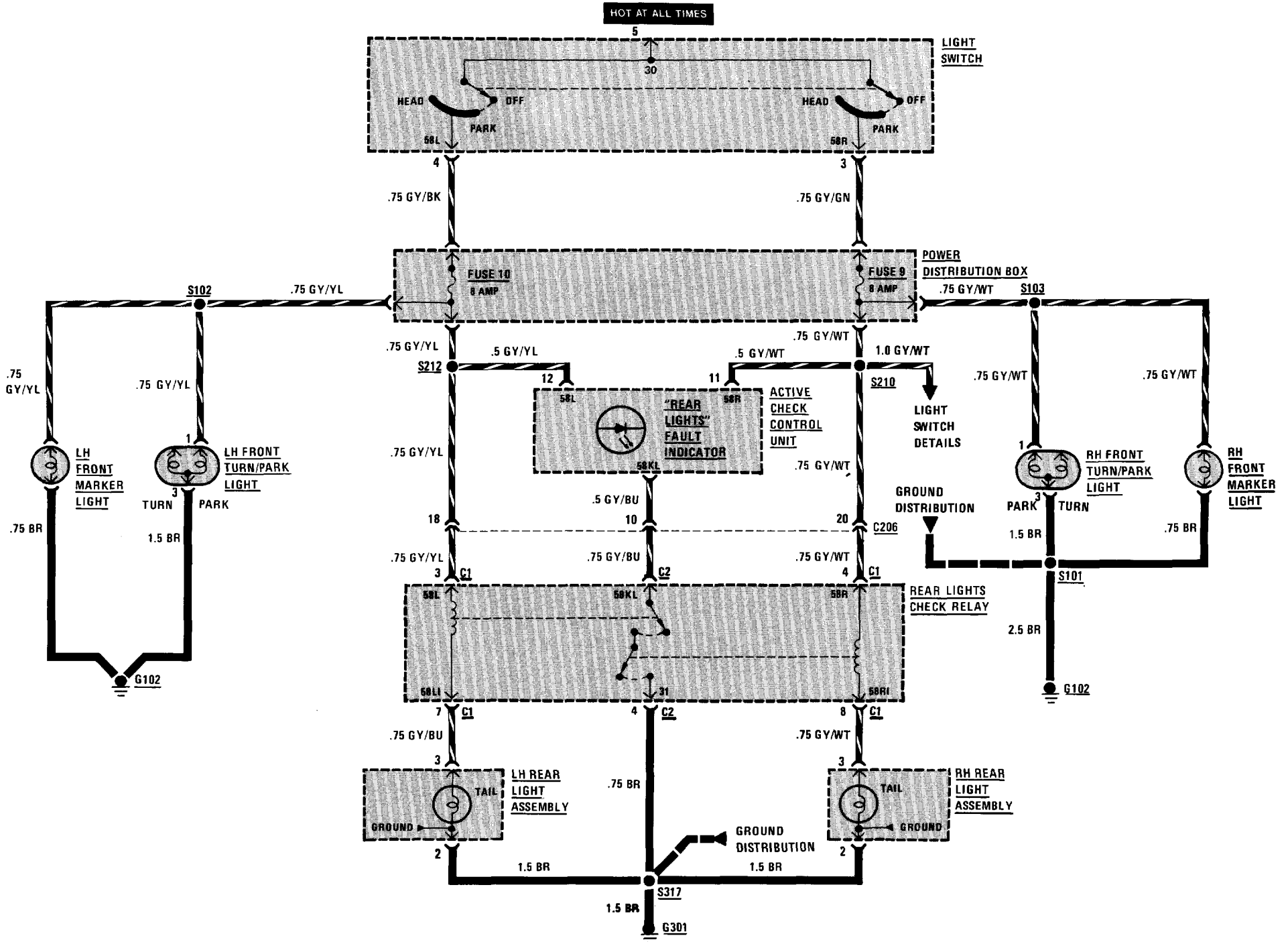

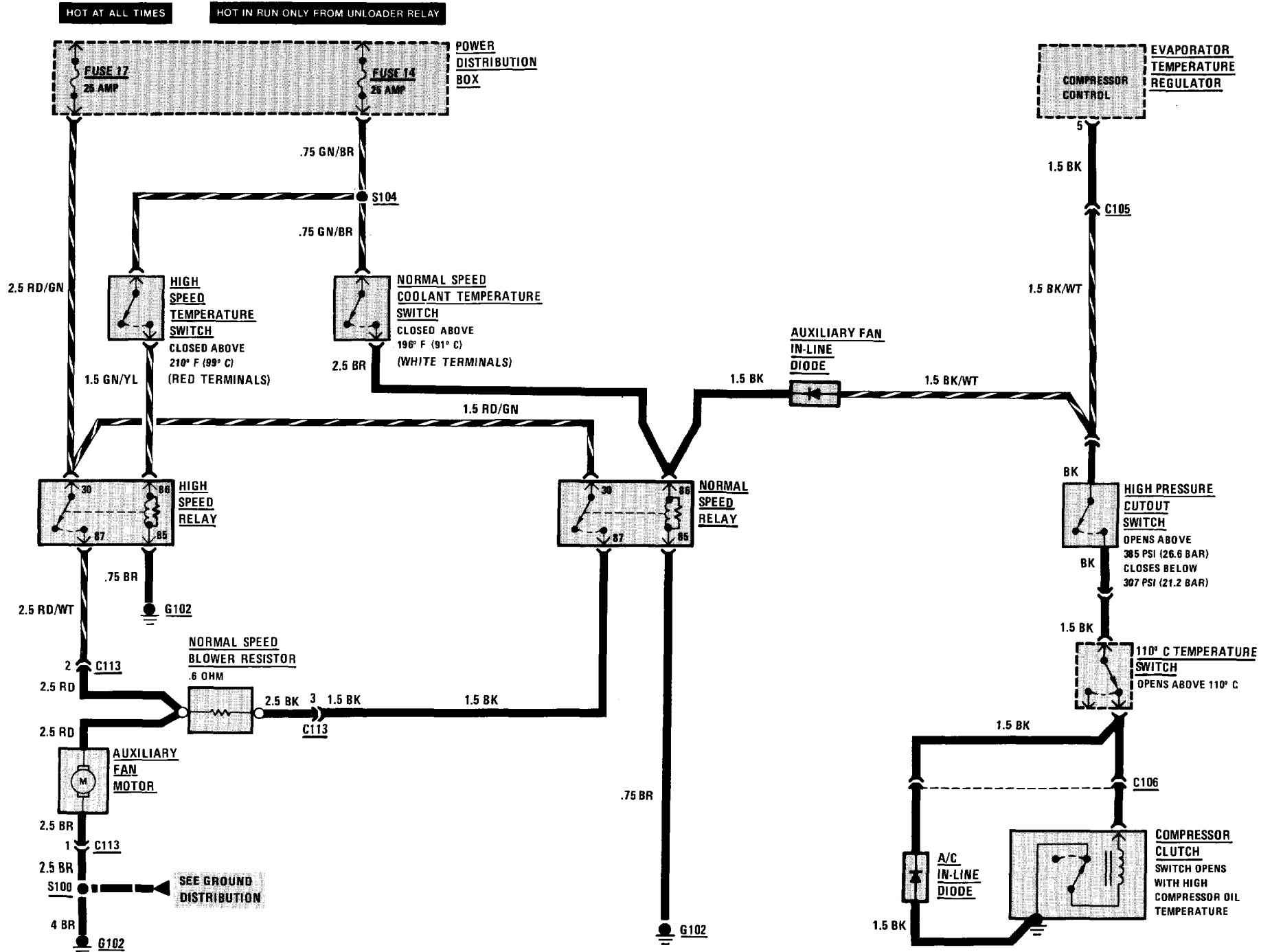

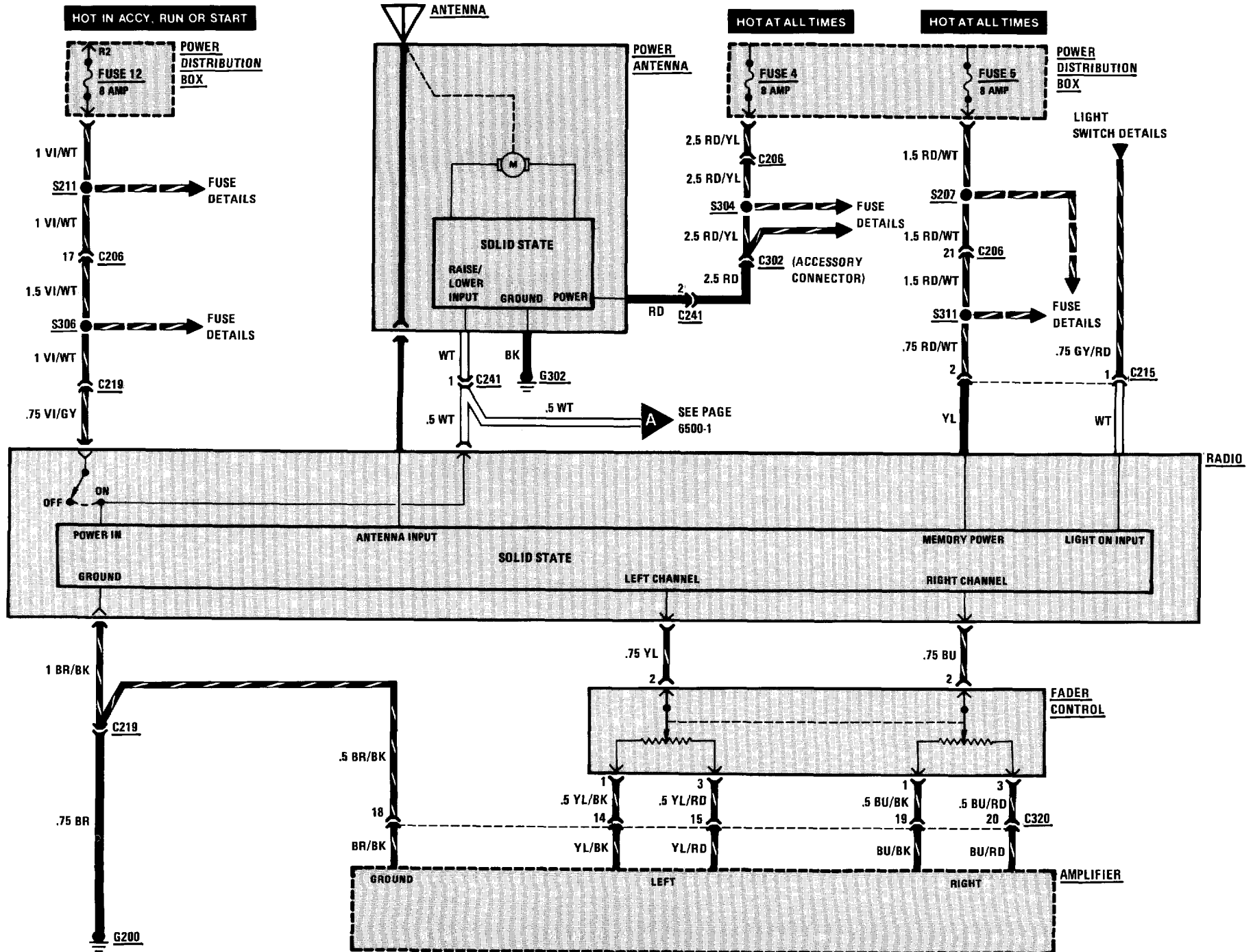

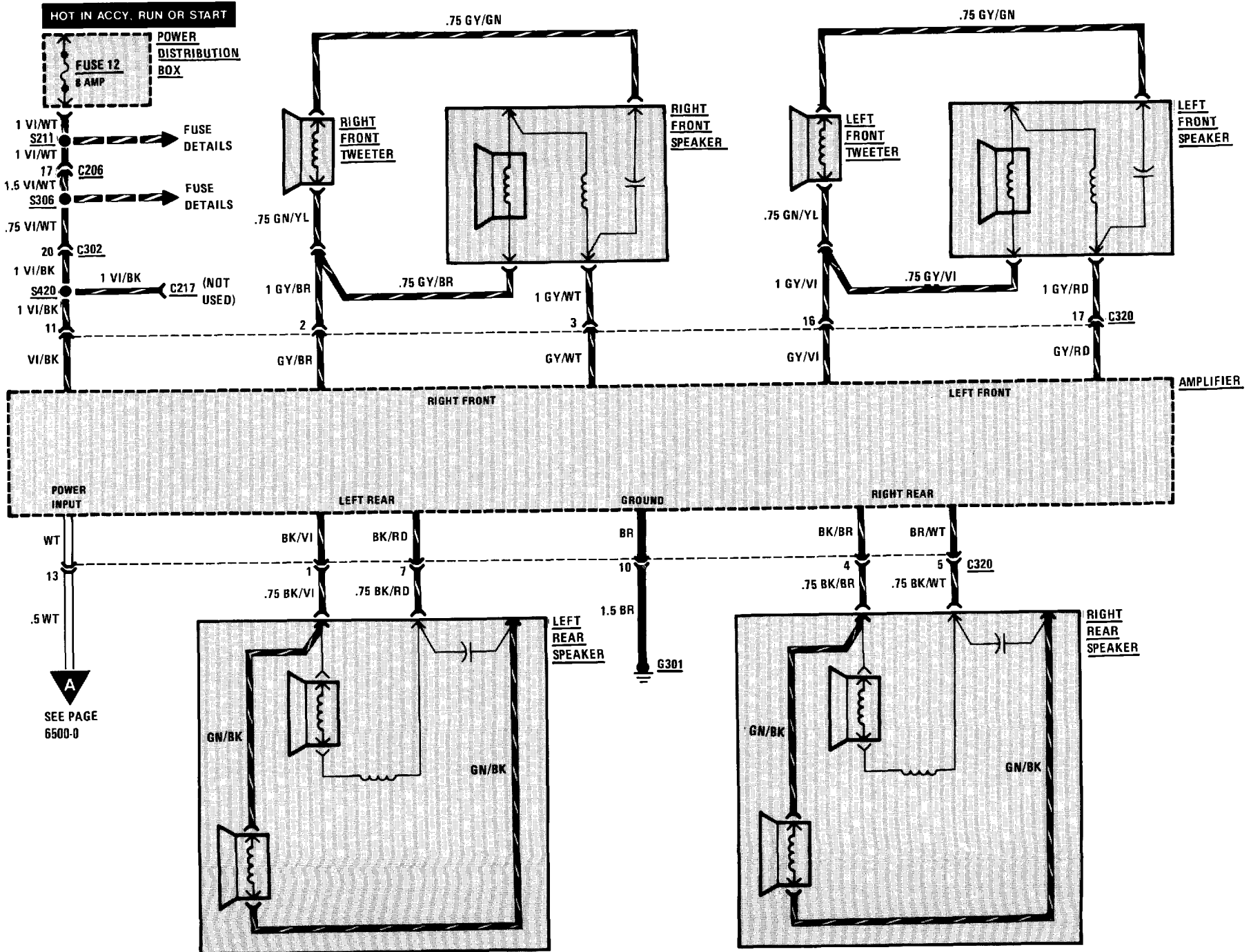

WITHOUT SOUND SYSTEM

(For Component Locations See Page 211)

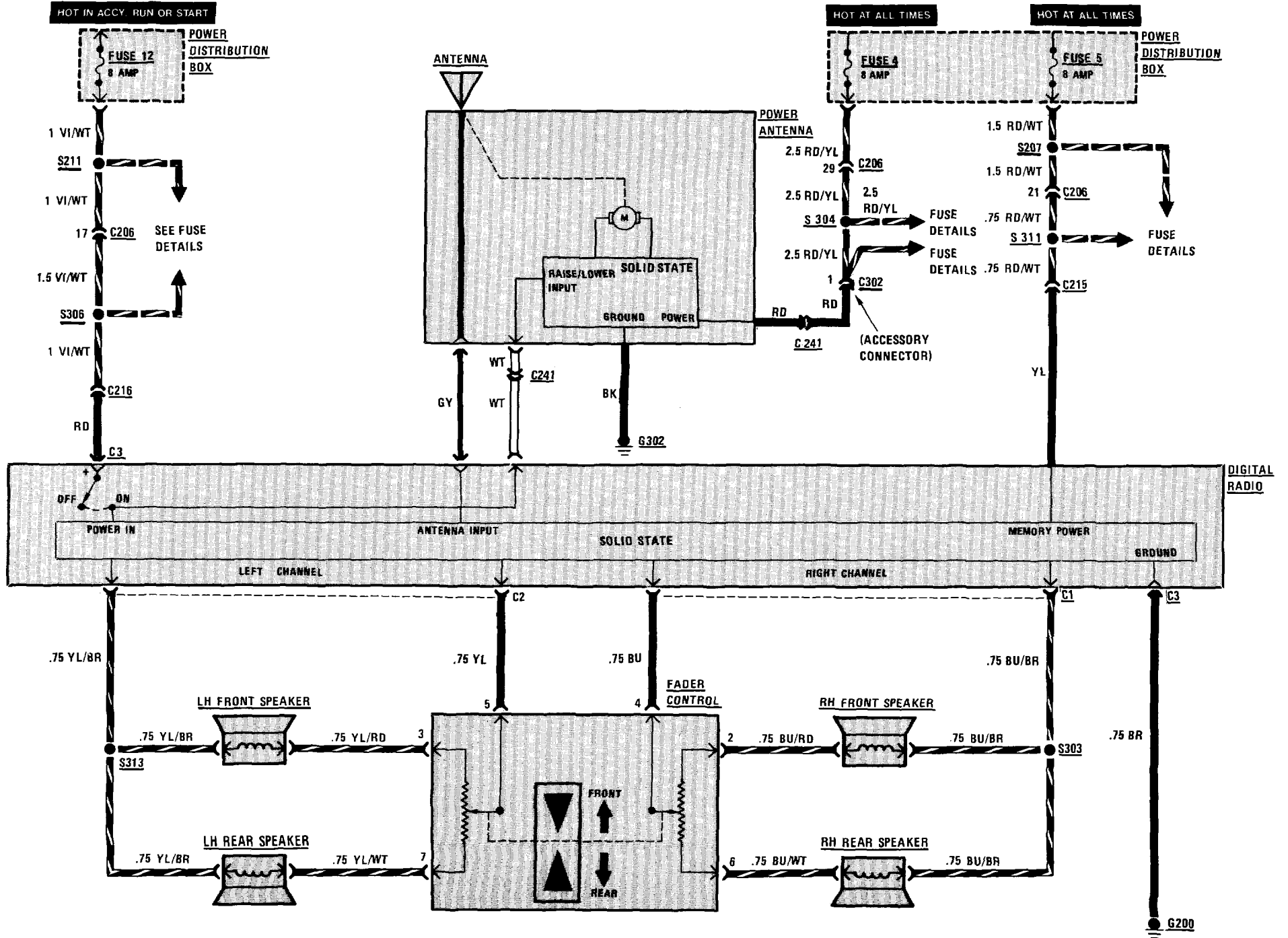

EARLY PRODUCTION

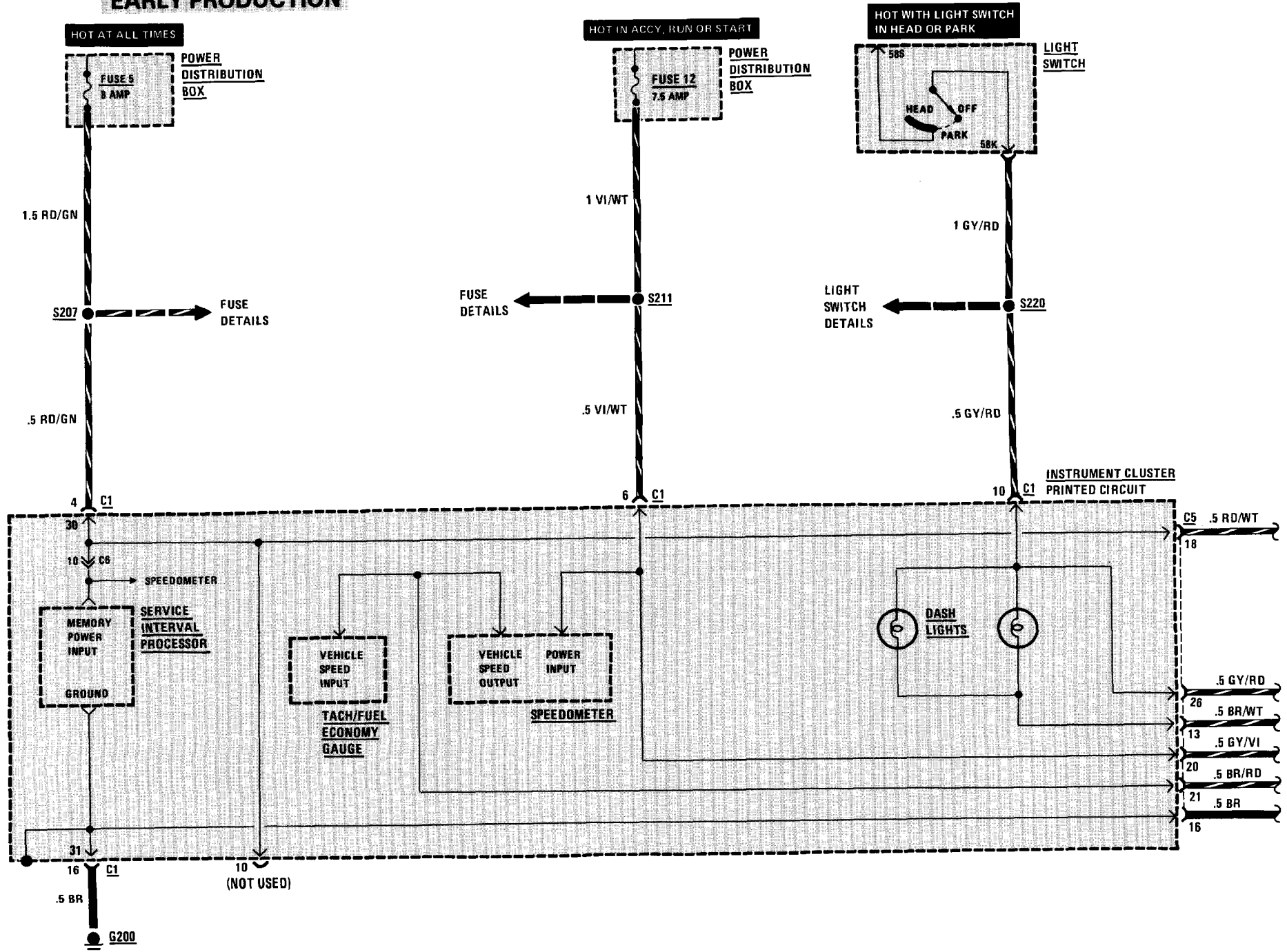

EARLY PRODUCTION

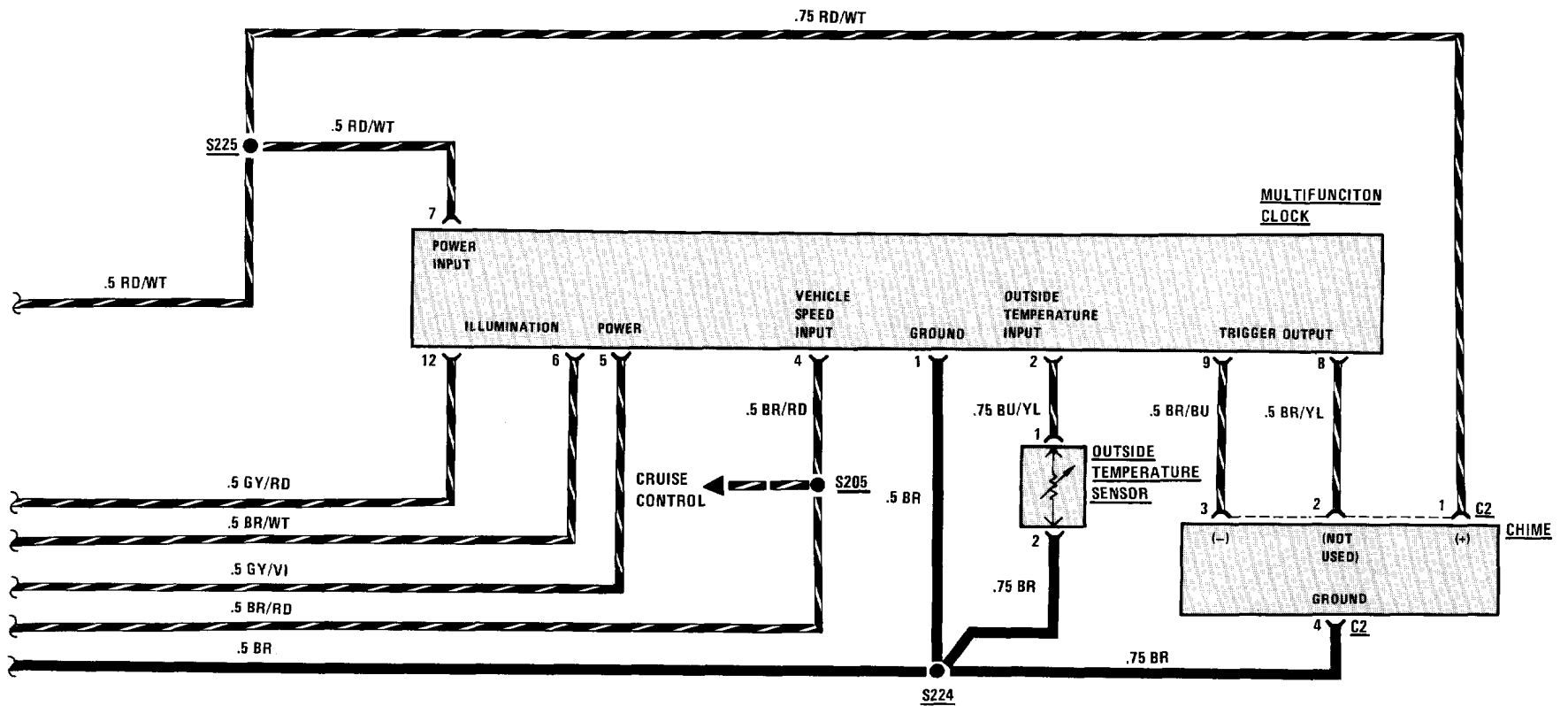

LATE PRODUCTION

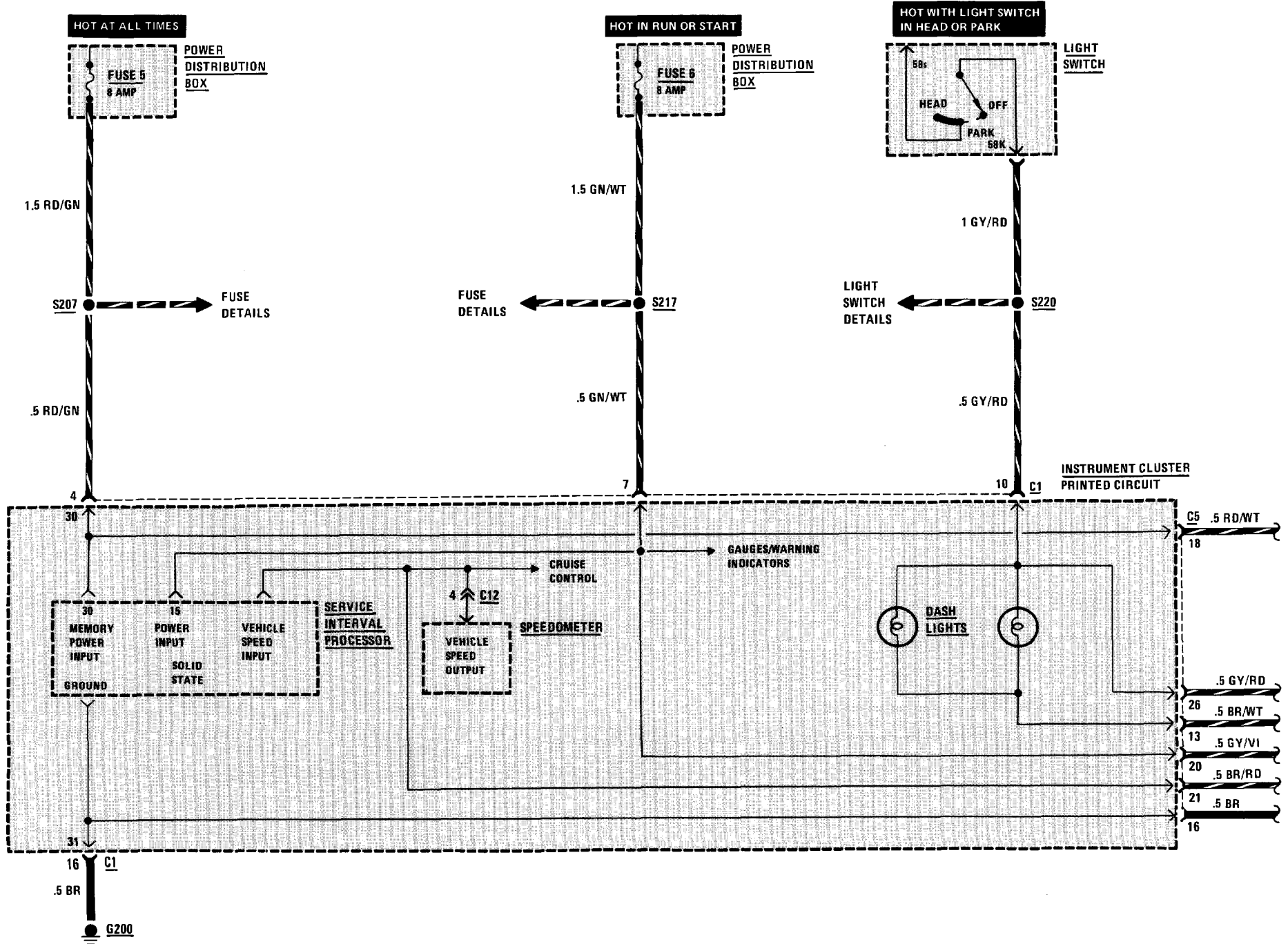

LATE PRODUCTION

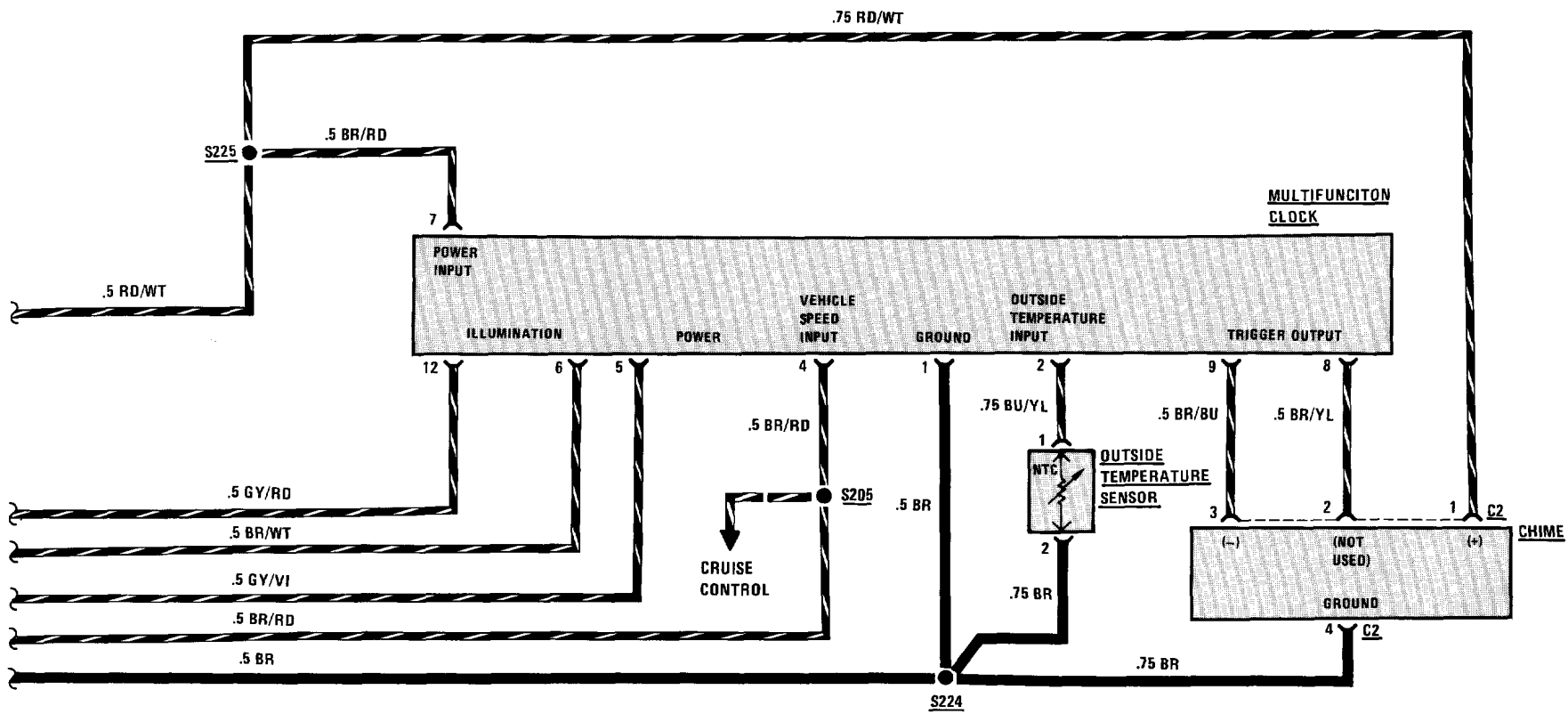

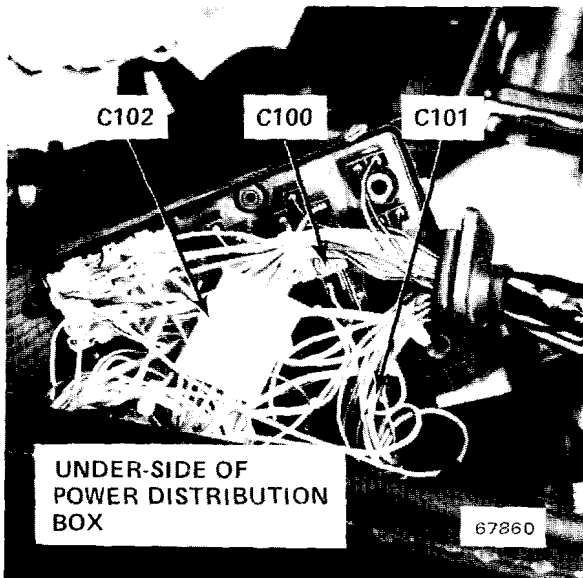

Figure 1 - Top of LH Front Wheel Well

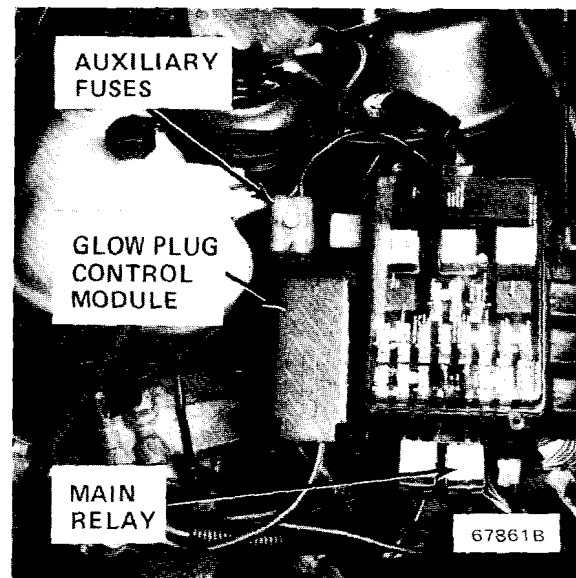

Figure 3 - Top of LH Front Wheel Well

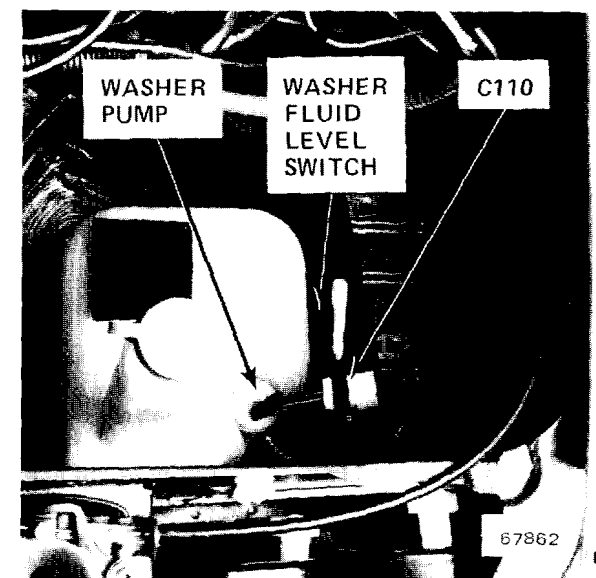

Figure 5 - Behind LH Headlights (Battery Removed)

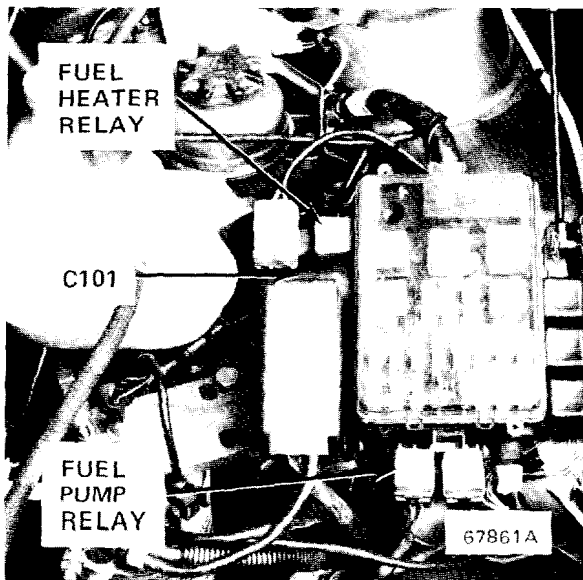

Figure 2 - Top of LH Front Wheel Well

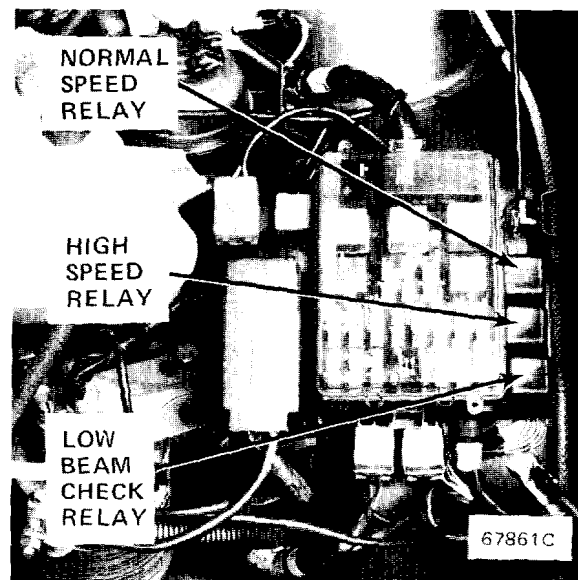

Figure 4 - Top of LH Front Wheel Well

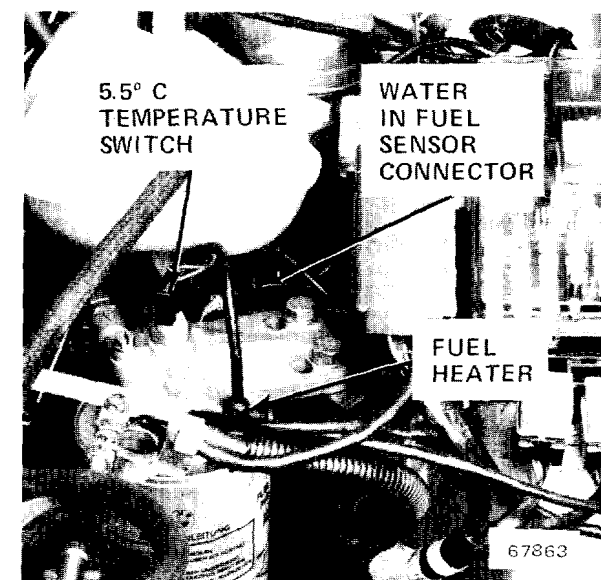

Figure 6 - Near LH Front Wheel Well

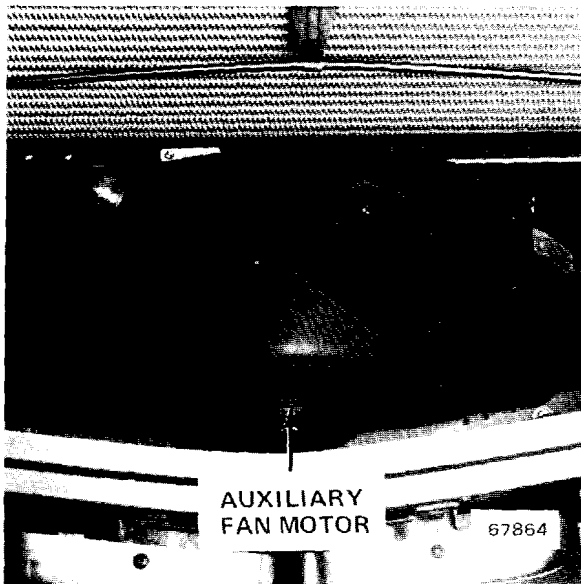

Figure 1 - Ahead of Radiator

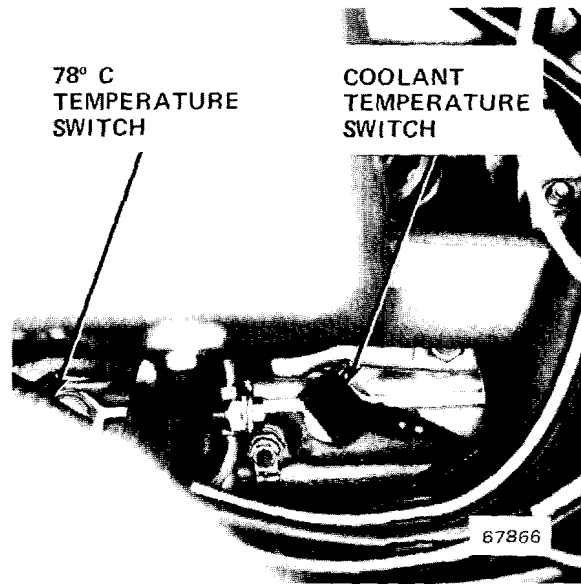

Figure 3 - LH Rear of Engine



Figure 5 - RH Front of Engine (Air Cleaner Removed)

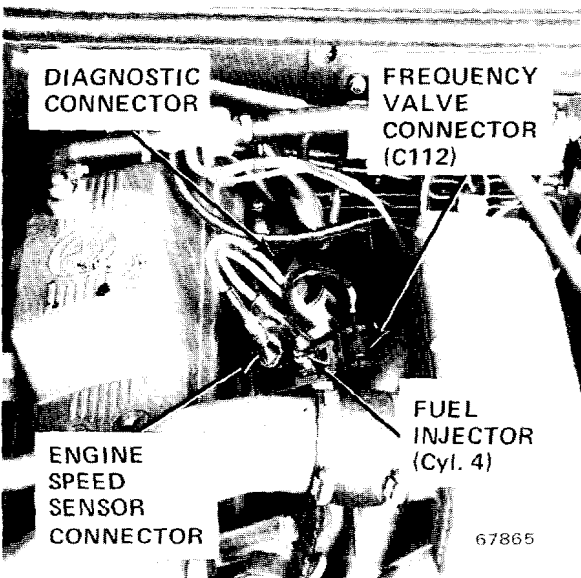

Figure 2 - Top Rear of Engine



Figure 4 - Near RH Shock Tower

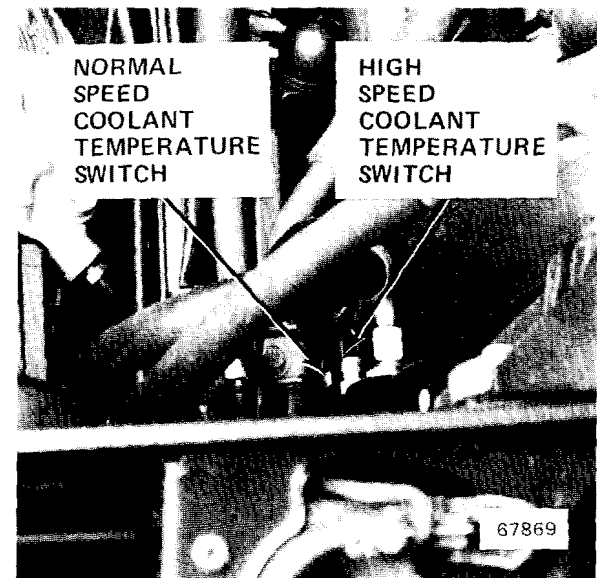

Figure 6 - Lower RH Side of Radiator (Air Cleaner Removed)

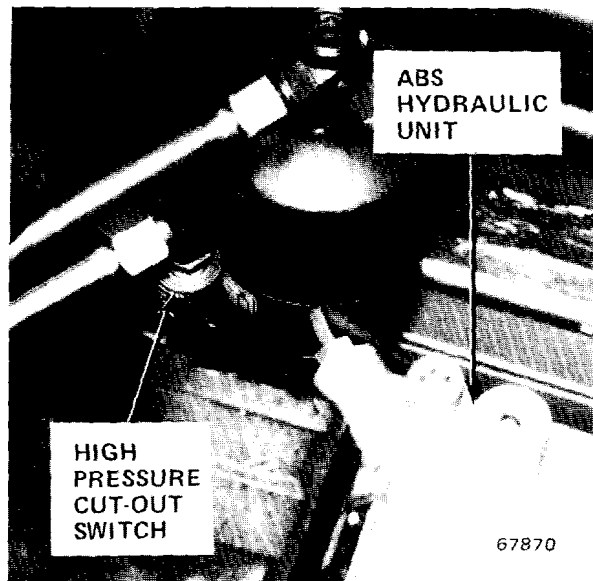

Figure 1 - RH Front of Engine Compartment (Air Cleaner Removed)



Figure 3 - LH Side of Engine

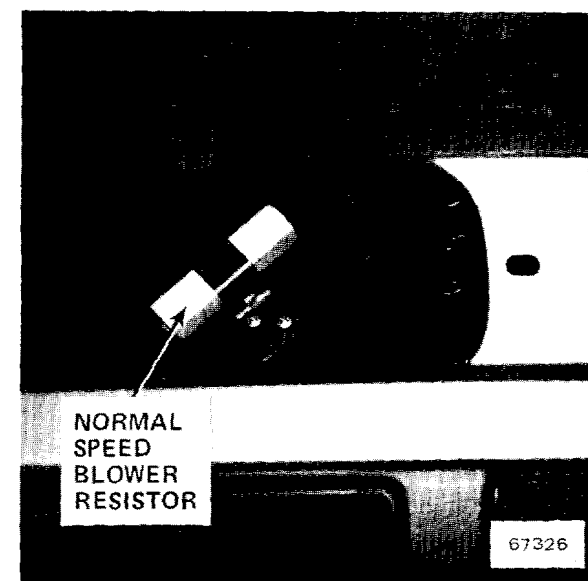

Figure 5 - Ahead of Radiator

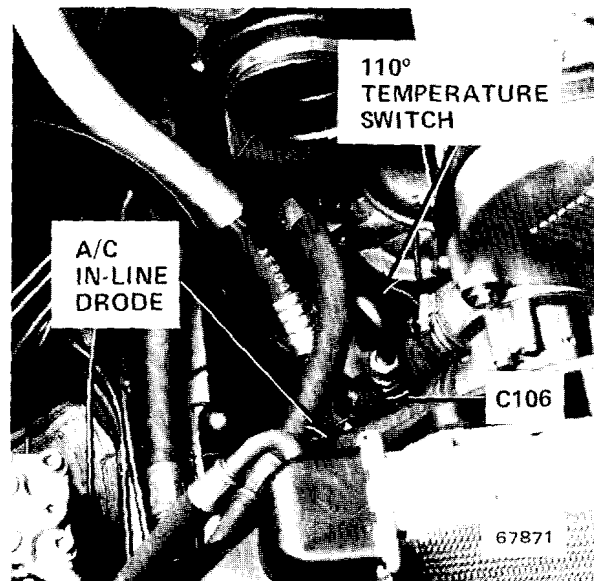

Figure 2 - RH Front of Engine Compartment (Air Cleaner Removed)

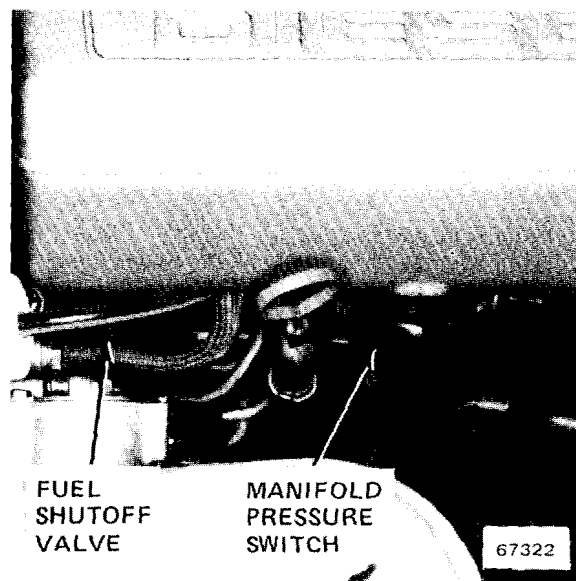

Figure 4 - LH Front of Engine

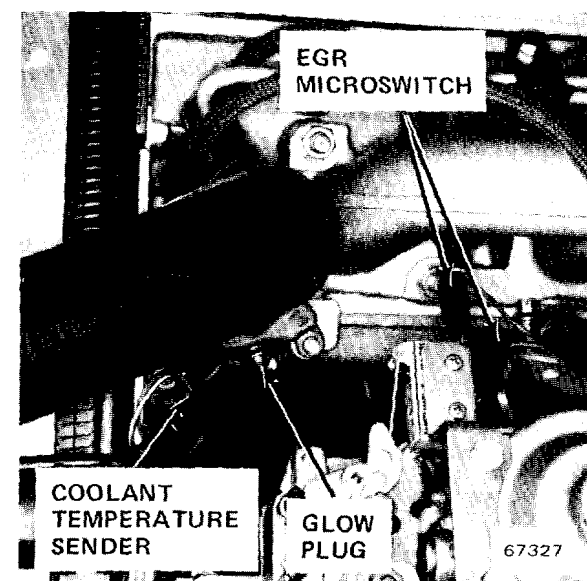

Figure 6 - LH Front of Engine

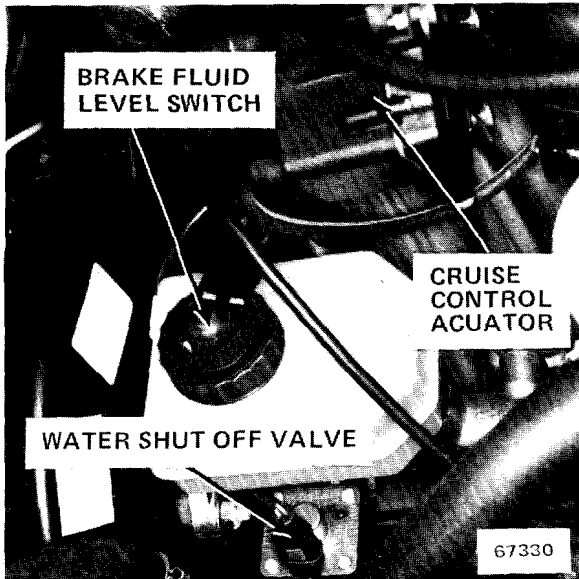

Figure 1 - LH Rear of Engine Compartment



Figure 3 - Near LH Shock Tower

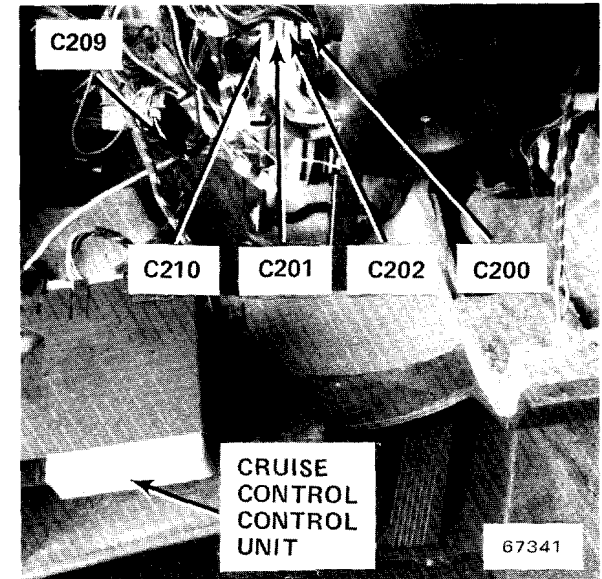

Figure 5 - Lower LH Side of Dash

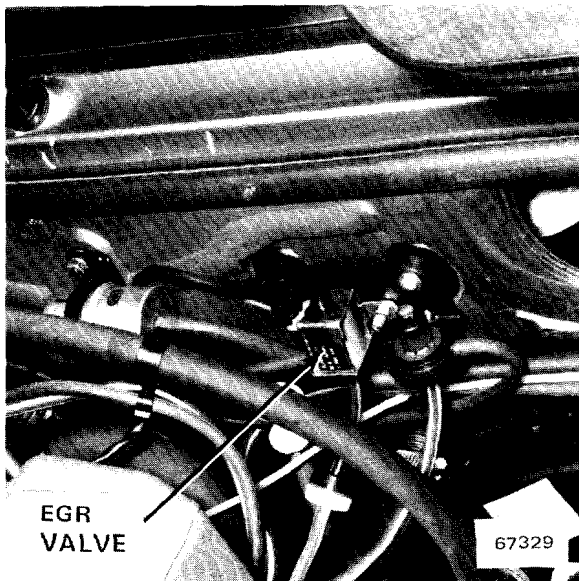

Figure 2 - LH Side of Bulkhead

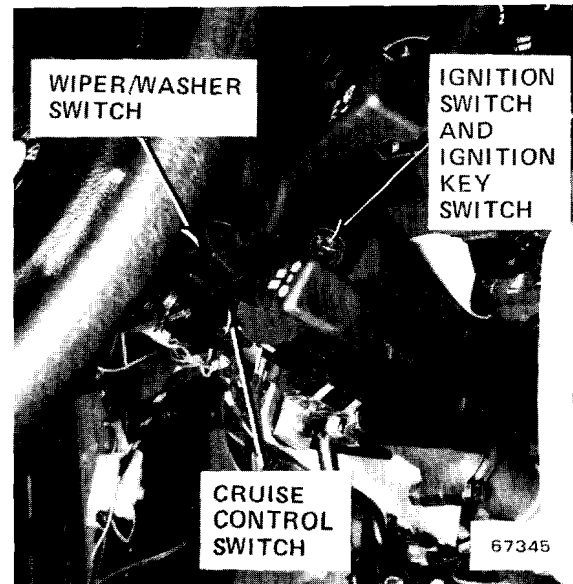

Figure 4 - Upper Part of Steering Column

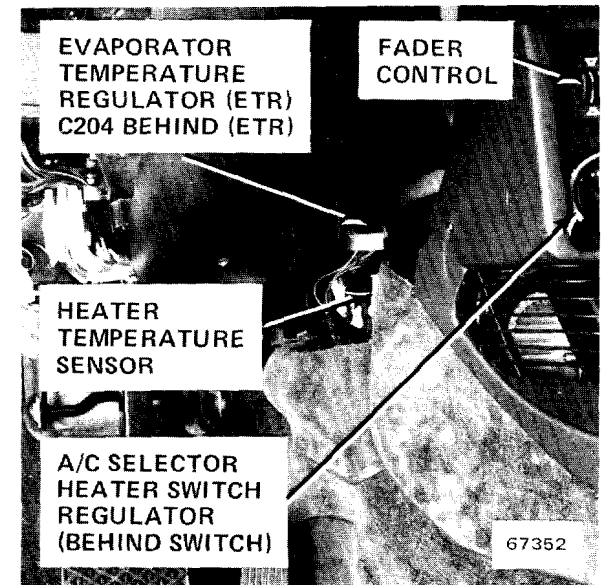

Figure 6 - LH Side of Upper Console

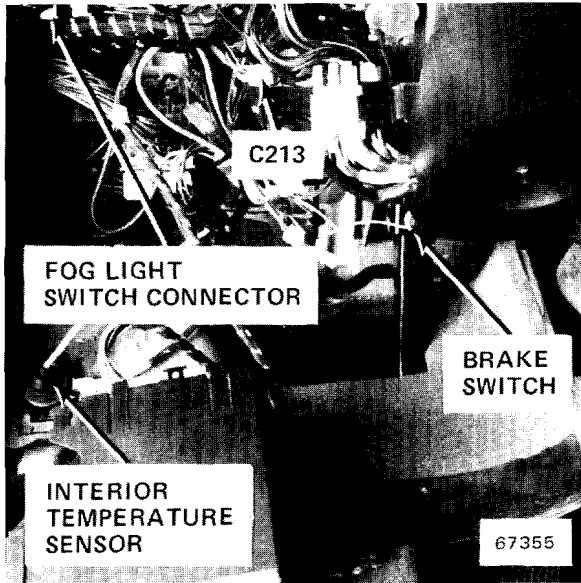

Figure 1 - Lower LH Side of Dash

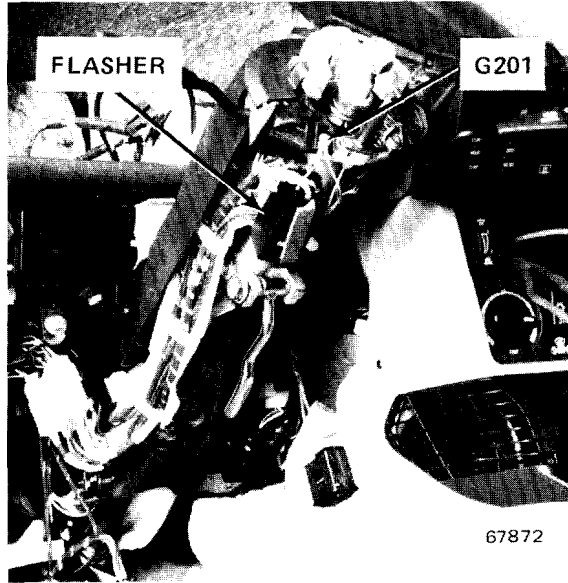

Figure 3 - Steering Column



Figure 5 - Under LH Side of Dash

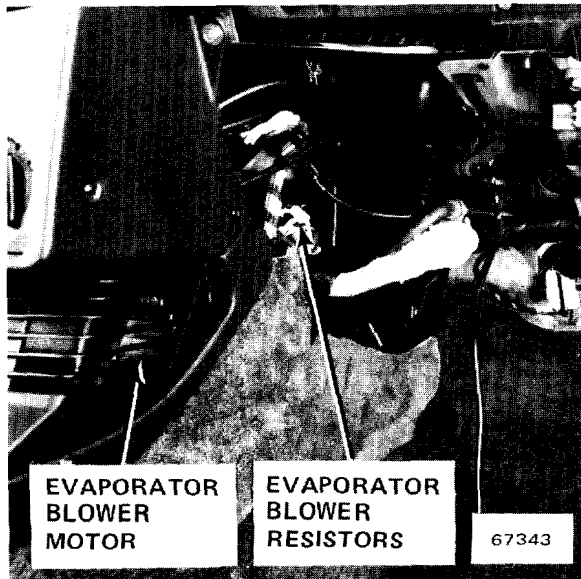

Figure 2 - RH Side of Upper Console

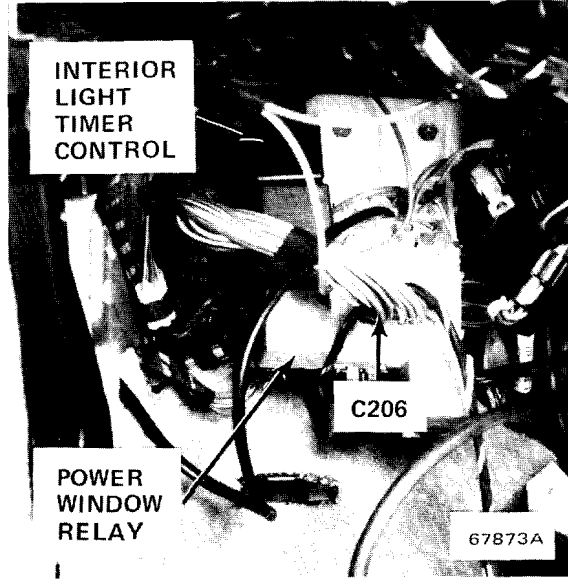

Figure 4 - Under LH Side of Dash



Figure 6 - Under LH Side of Dash



Figure 1 - Upper Part of Steering Column

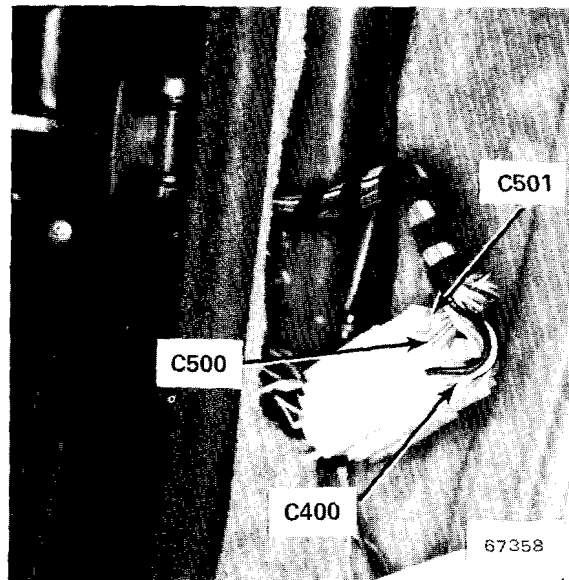

Figure 3 - LH Front Kick Panel

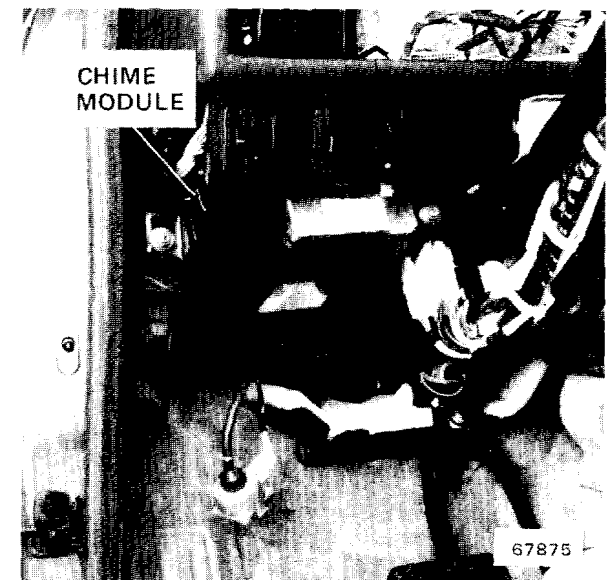

Figure 5 - Lower LH Side of Dash

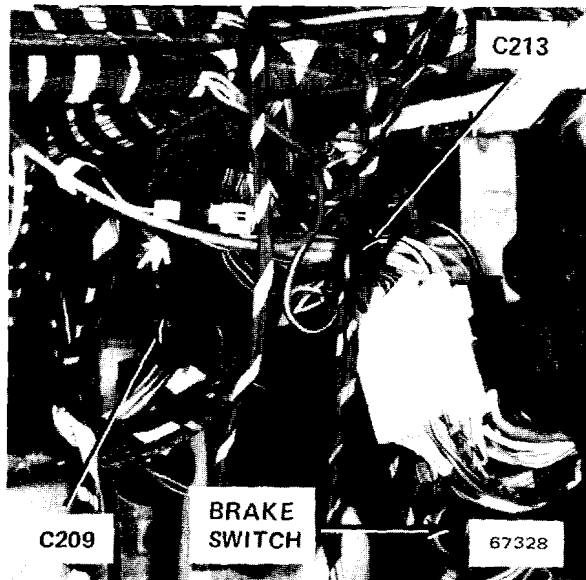

Figure 2 - Lower LH Side of Dash

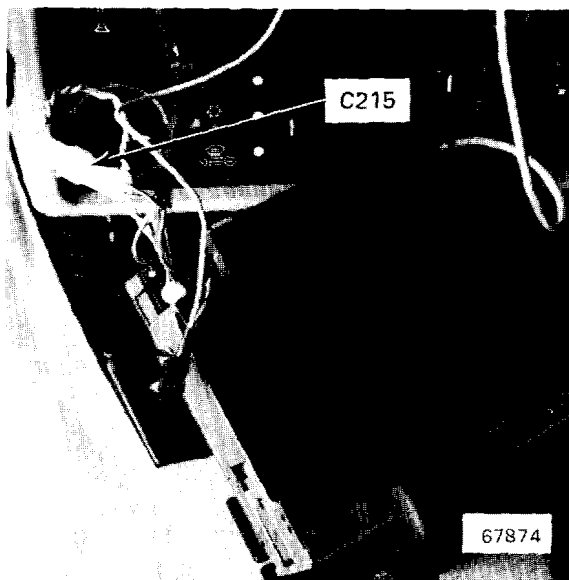

Figure 4 - Back of Radio

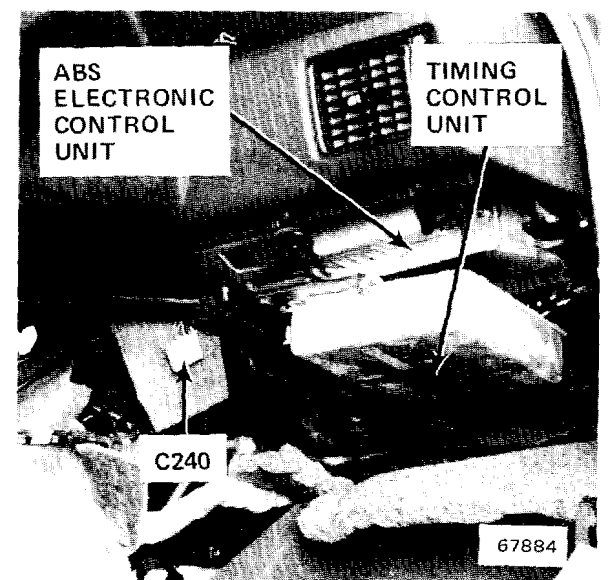

Figure 6 - Above Glove Box

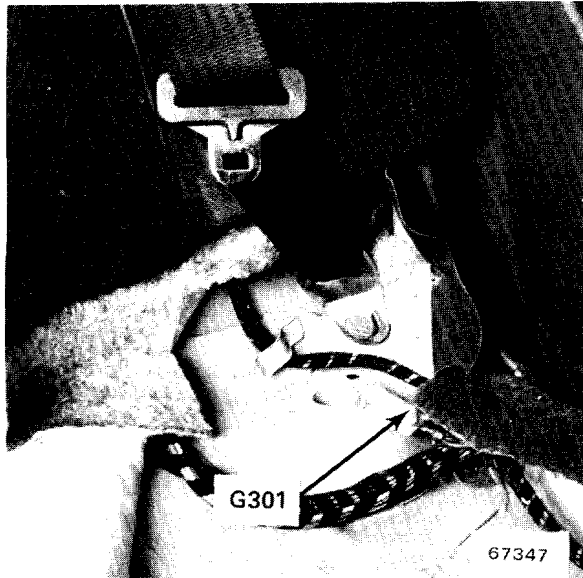

Figure 1 - Under LH Rear Seat

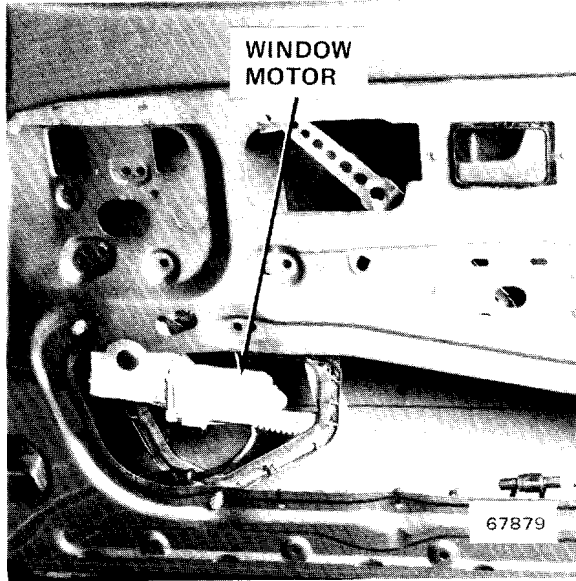

Figure 3 - Inside RH Front Door

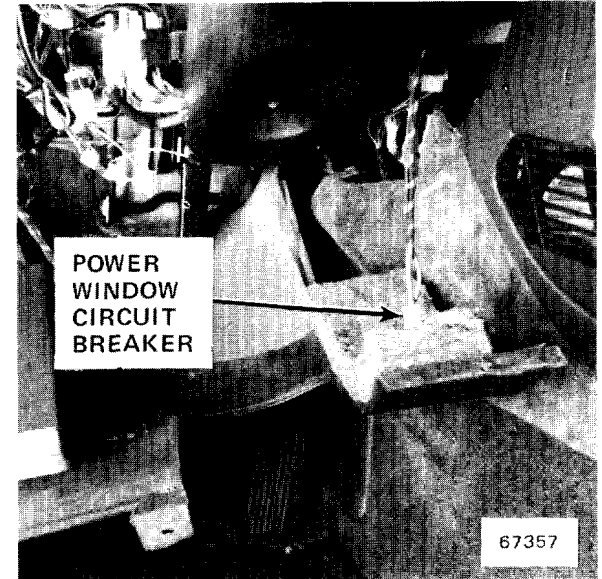

Figure 5 - Left of Upper Console

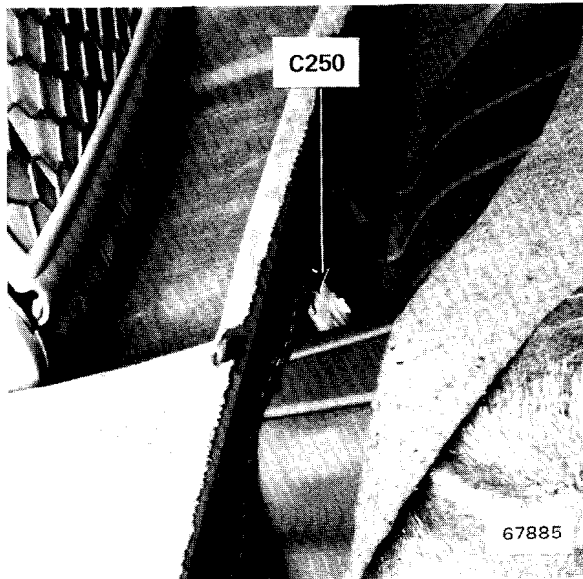

Figure 2 - Under Center of Rear Seat

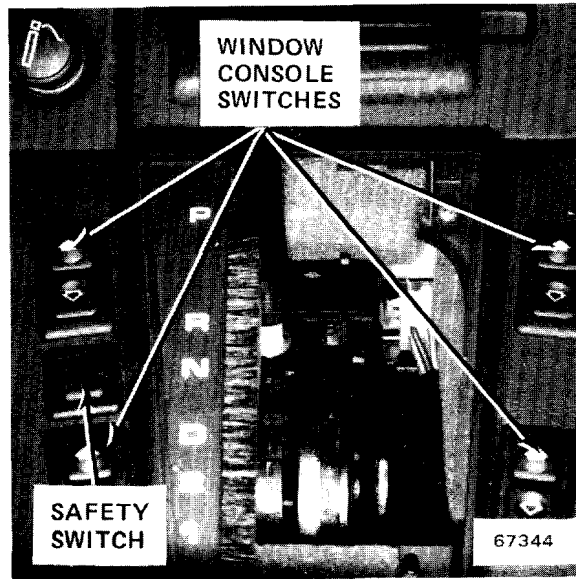

Figure 4 - Shift Console Near Shift Lever

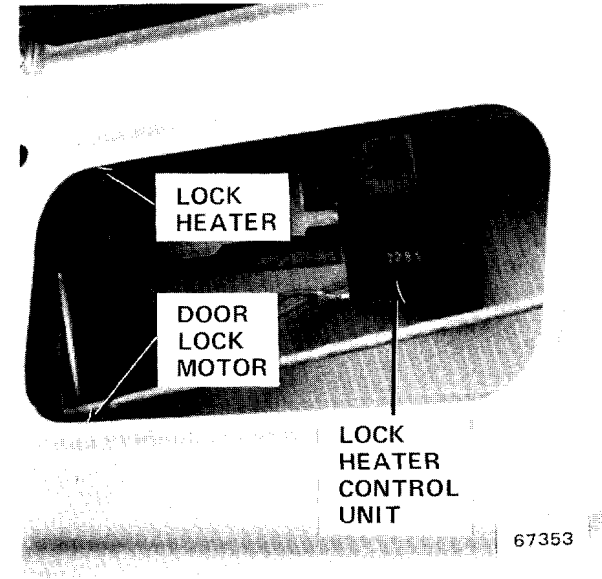

Figure 6 - Inside Driver's Door

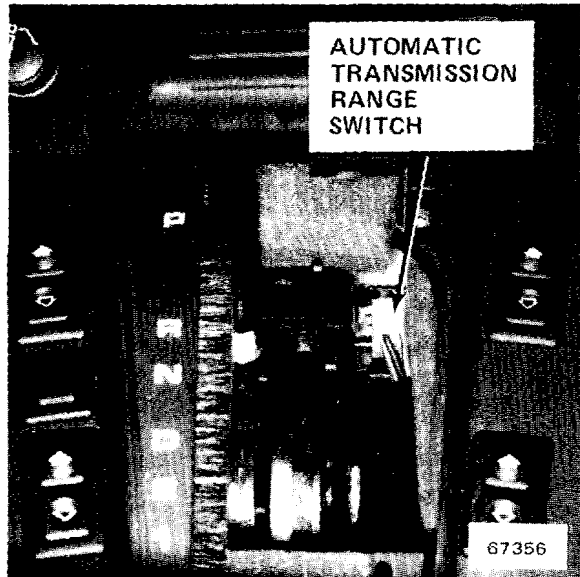

Figure 1 - Console, At Gearshift Selector

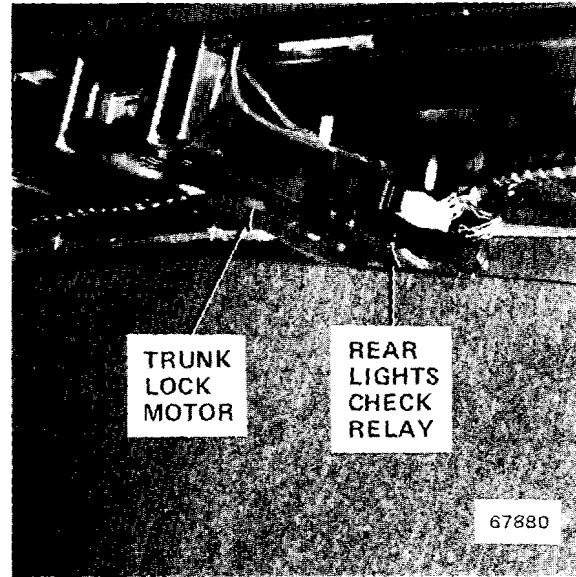

Figure 3 - Trunk Lock Support

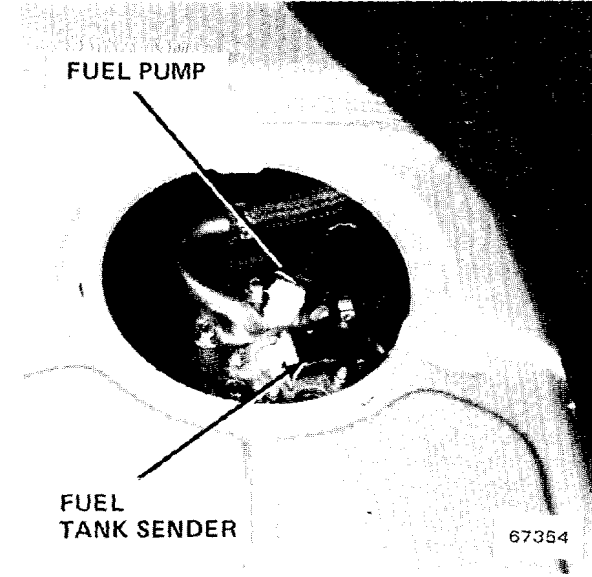

Figure 5 - Bottom RH Side of Trunk

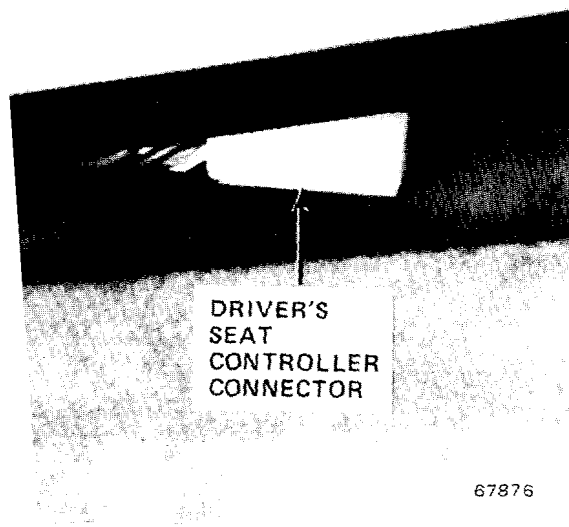

Figure 2 - Under Front of Driver's Seat

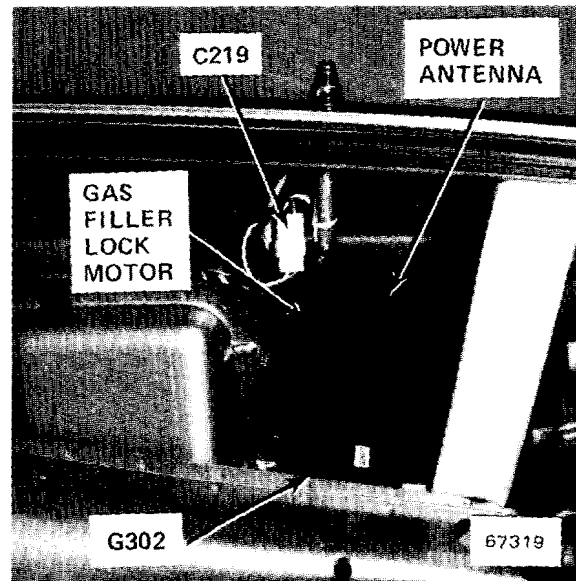

Figure 4 - RH Rear of Trunk

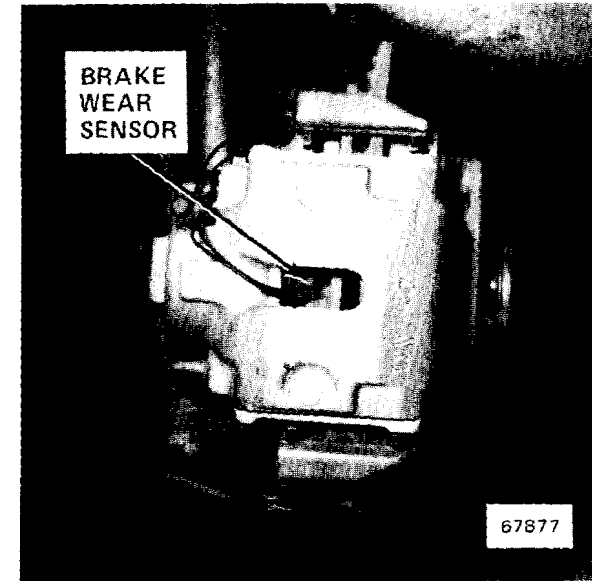

Figure 6 - LH Front Brake Assembly (RH Rear Similar)

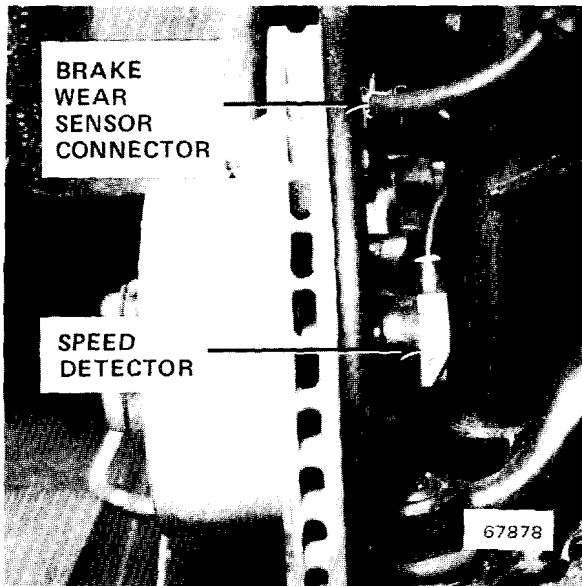

Figure 1 - LH Front Rotor (Others Similar)

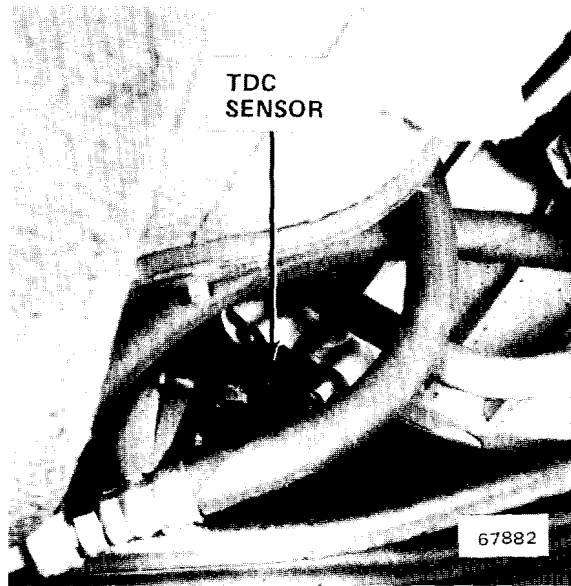

Figure 3 - LH Side of Transmission Bell Housing

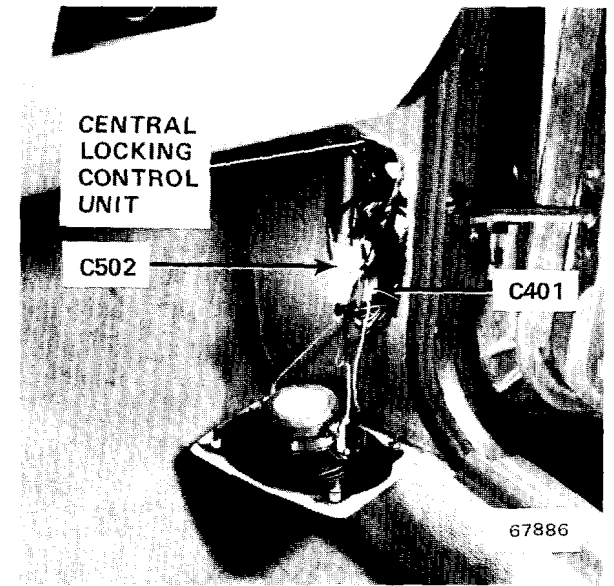

Figure 5 - RH Front Kick Panel

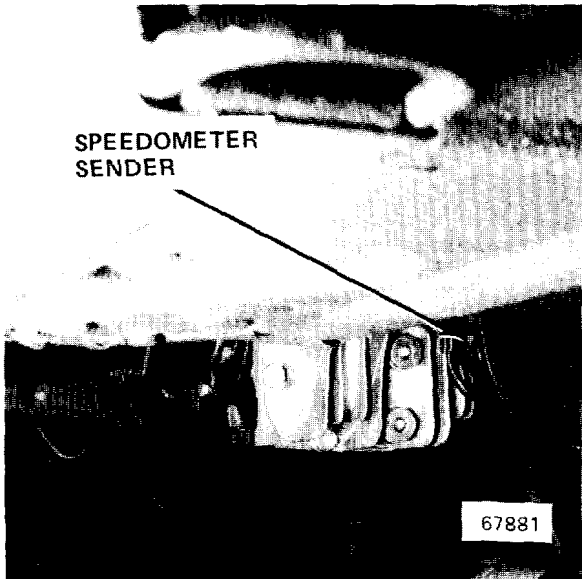

Figure 2 - Rear of Differential

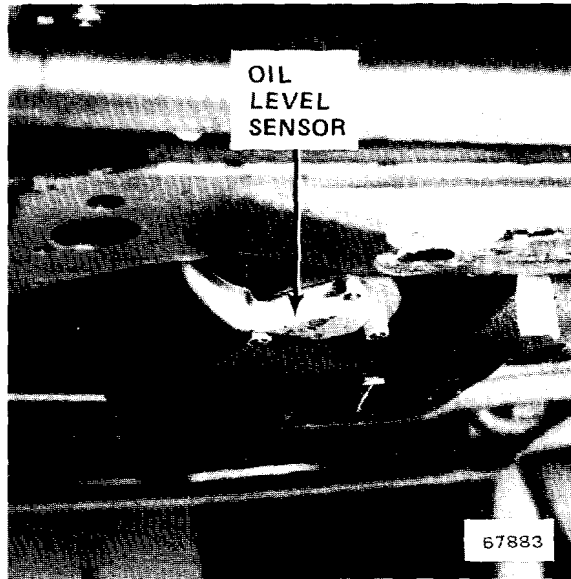

Figure 4 - Bottom of Oil Pan

INDEX

This index contains all the splices in the car, what harness each one is in, and the page that the splices appear on. The drawings after the index show how the harness is routed through the car and where the splices are located on the harness.

SPLICE	HARNESS	PAGE NUMBER	SPLICE	HARNESS	PAGE NUMBER
S100	FRONT	8000-3	S213	MIDDLE	8000-4
S101	FRONT	8000-3	S214	MIDDLE	8000-4
S102	FRONT	8000-3	S215	MIDDLE	8000-4
S103	FRONT	8000-3	S216	MIDDLE	8000-4
S104	FRONT	NOT SHOWN	S217	MIDDLE	8000-4
S107	ENGINE	8000-2	S218	MIDDLE	8000-4
S109	ENGINE	8000-2	S219	MIDDLE	8000-4
S110	ENGINE	8000-2	S220	MIDDLE	8000-4
S112	ENGINE	8000-2	S221	CRUISE	NOT SHOWN
S113	ENGINE	8000-2	S222	CONTROL	8000-6
S115	ENGINE	8000-2	S223	CRUISE	8000-6
S118	HEATED WASHER JETS	NOT SHOWN	S224	CONTROL	8000-6
S119	HEATED WASHER JETS	NOT SHOWN	S225	A/C	8000-6
S120	FRONT	8000-3	S226	A/C	8000-6
S121	ENGINE	8000-2	S227	A/C	8000-6
S200	MIDDLE	8000-4	S228	A/C	8000-6
S201	MIDDLE	8000-4	S229	A/C	8000-6
S202	MIDDLE	8000-4	S230	MIDDLE	NOT SHOWN
S203	MIDDLE	8000-4	S231	MIDDLE	8000-4
S204	MIDDLE	8000-4	S232	MIDDLE	8000-4
S205	MIDDLE	8000-4	S233	MIDDLE	8000-4
S206	MIDDLE	8000-4	S300	REAR	8000-5
S207	MIDDLE	8000-4	S303	REAR	8000-5
S209	MIDDLE	8000-4	S304	REAR	8000-5
S210	MIDDLE	8000-4	S305	REAR	8000-5
S211	MIDDLE	8000-4			
S212	MIDDLE	8000-4			

INDEX

SPLICE	HARNESS	PAGE NUMBER	SPLICE	HARNESS	PAGE NUMBER
S306	REAR	8000-5	S408	ELEC LOCK/ CENTRAL LOCK	8000-7
S308	REAR	8000-5	S409	ELEC LOCK/ CENTRAL LOCK	NOT SHOWN
S309	REAR	8000-5	S410	ELEC LOCK/ CENTRAL LOCK	8000-7
S310	REAR	8000-5	S411	ELEC LOCK/ CENTRAL LOCK	8000-7
S311	REAR	8000-5	S412	ELEC LOCK/ CENTRAL LOCK	8000-7
S312	REAR	8000-5	S414	ELEC LOCK/ CENTRAL LOCK	8000-7
S313	REAR	8000-5	S415	ELEC LOCK/ CENTRAL LOCK	8000-7
S314	REAR	8000-5	S416	ELEC LOCK/ CENTRAL LOCK	8000-7
S315	REAR	8000-5	S417	ELEC LOCK/ CENTRAL LOCK	8000-7
S316	REAR	8000-5	S418	DOOR	8000-8
S317	REAR	8000-5	S500	DOOR	8000-8
S318	REAR	8000-5	S501	DOOR	8000-8
S320	REAR	8000-5	S502	DOOR	8000-8
S400	ELEC LOCK/ CENTRAL LOCK	8000-7	S503	DOOR	8000-8
S401	ELEC LOCK/ CENTRAL LOCK	8000-7	S504	DOOR	8000-8
S402	ELEC LOCK/ CENTRAL LOCK	8000-7	S509	REAR	8000-5
S403	ELEC LOCK/ CENTRAL LOCK	8000-7	S600	SUNROOF	NOT SHOWN
S404	ELEC LOCK/ CENTRAL LOCK	8000-7	S601	SUNROOF	NOT SHOWN
S405	ELEC LOCK/ CENTRAL LOCK	8000-7			
S406	ELEC LOCK/ CENTRAL LOCK	8000-7			
S407	ELEC LOCK/ CENTRAL LOCK	8000-7			

ENGINE HARNESS

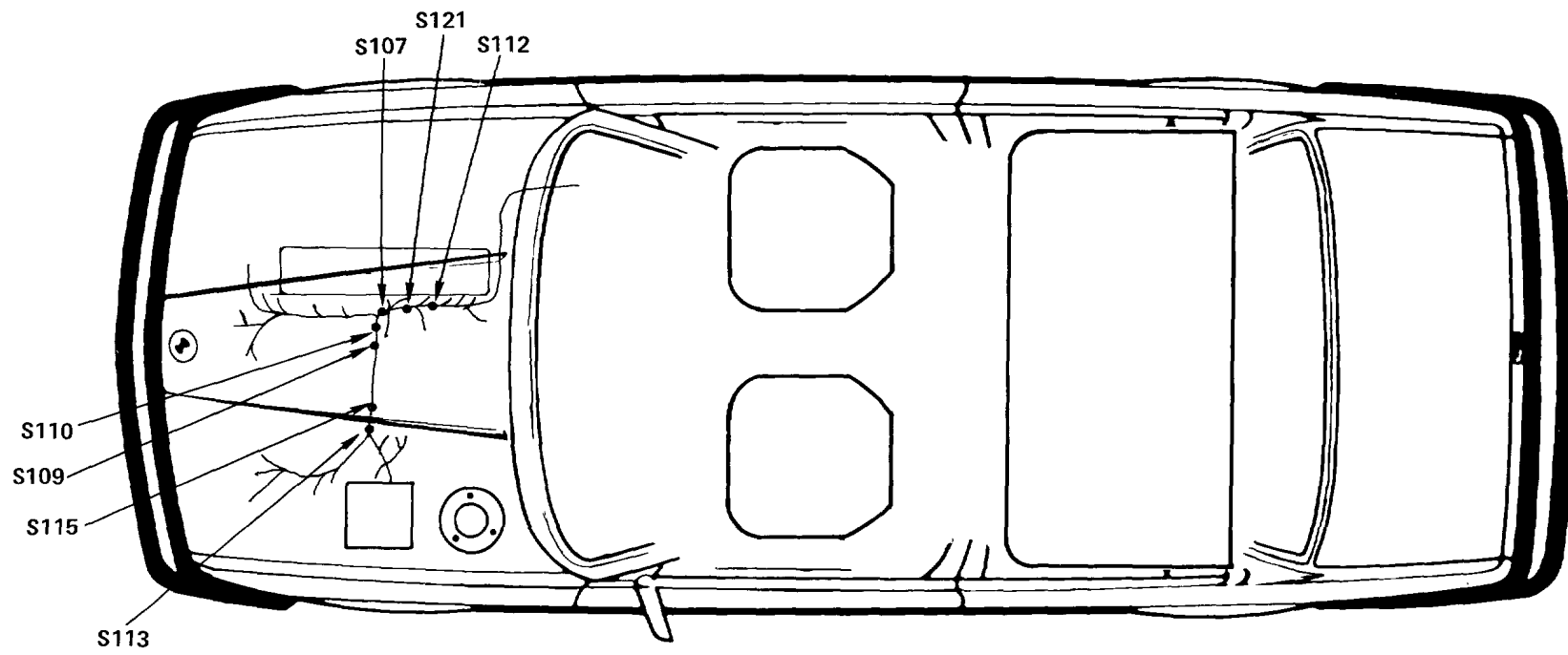

FRONT HARNESS

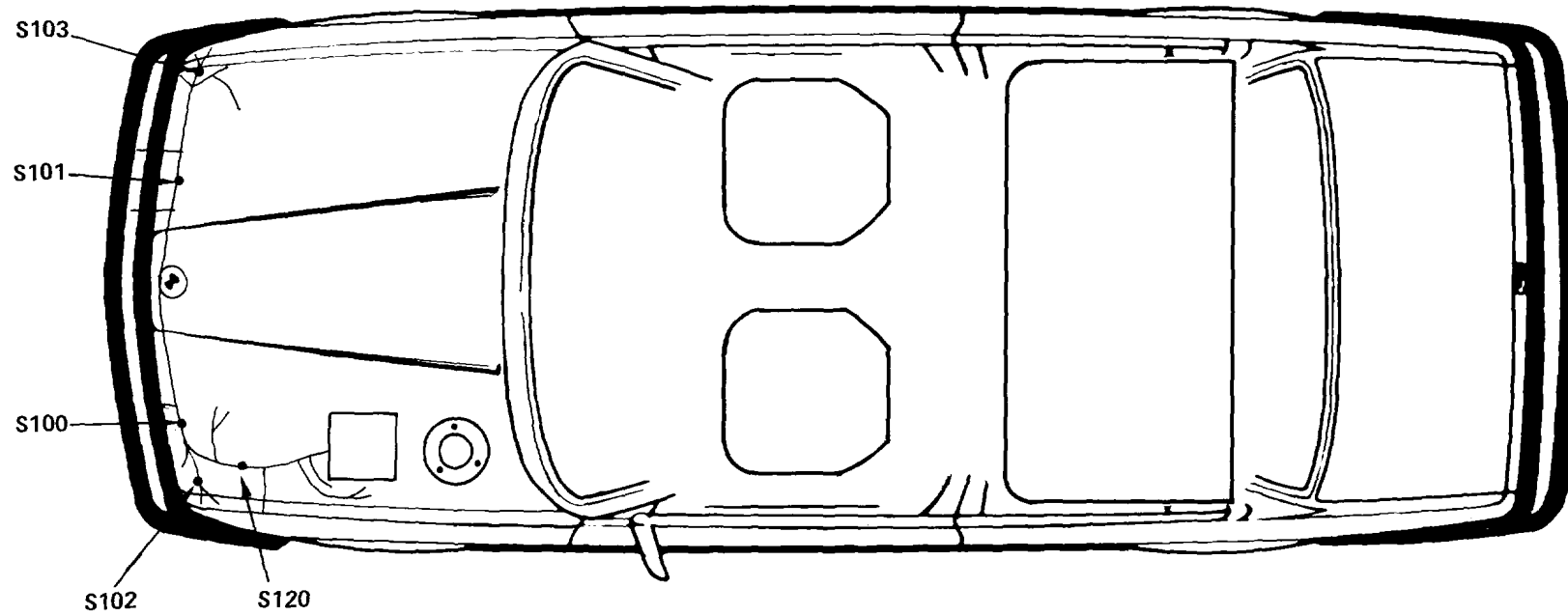

MIDDLE HARNESS

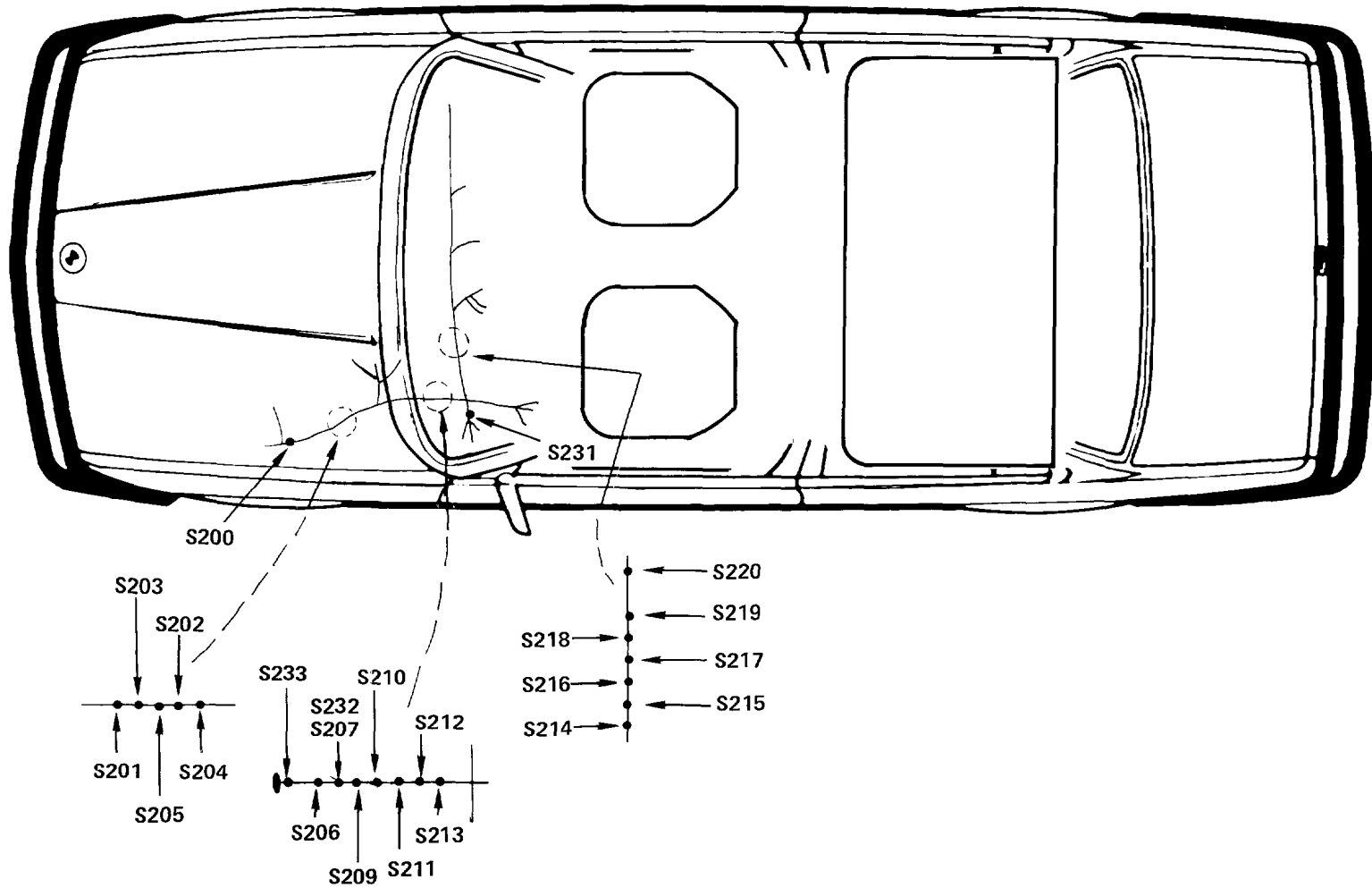

REAR HARNESS

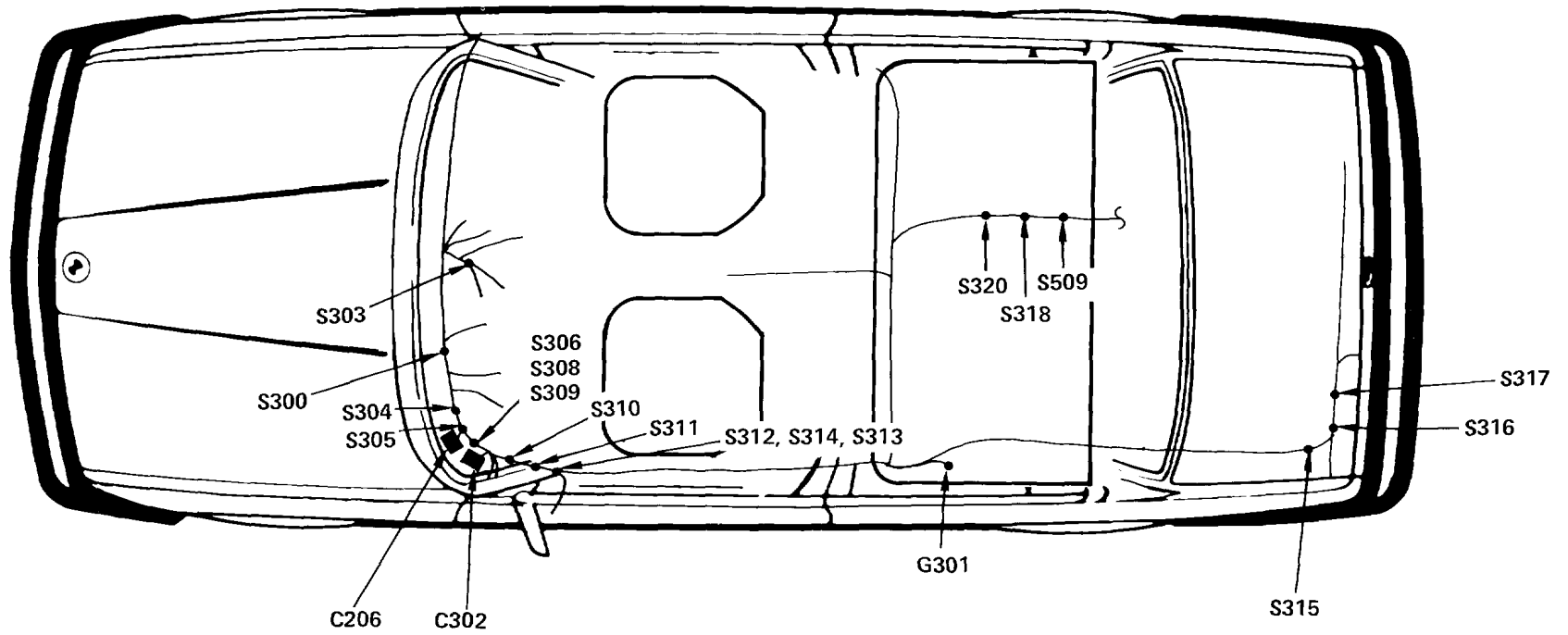

A/C AND CRUISE HARNESS

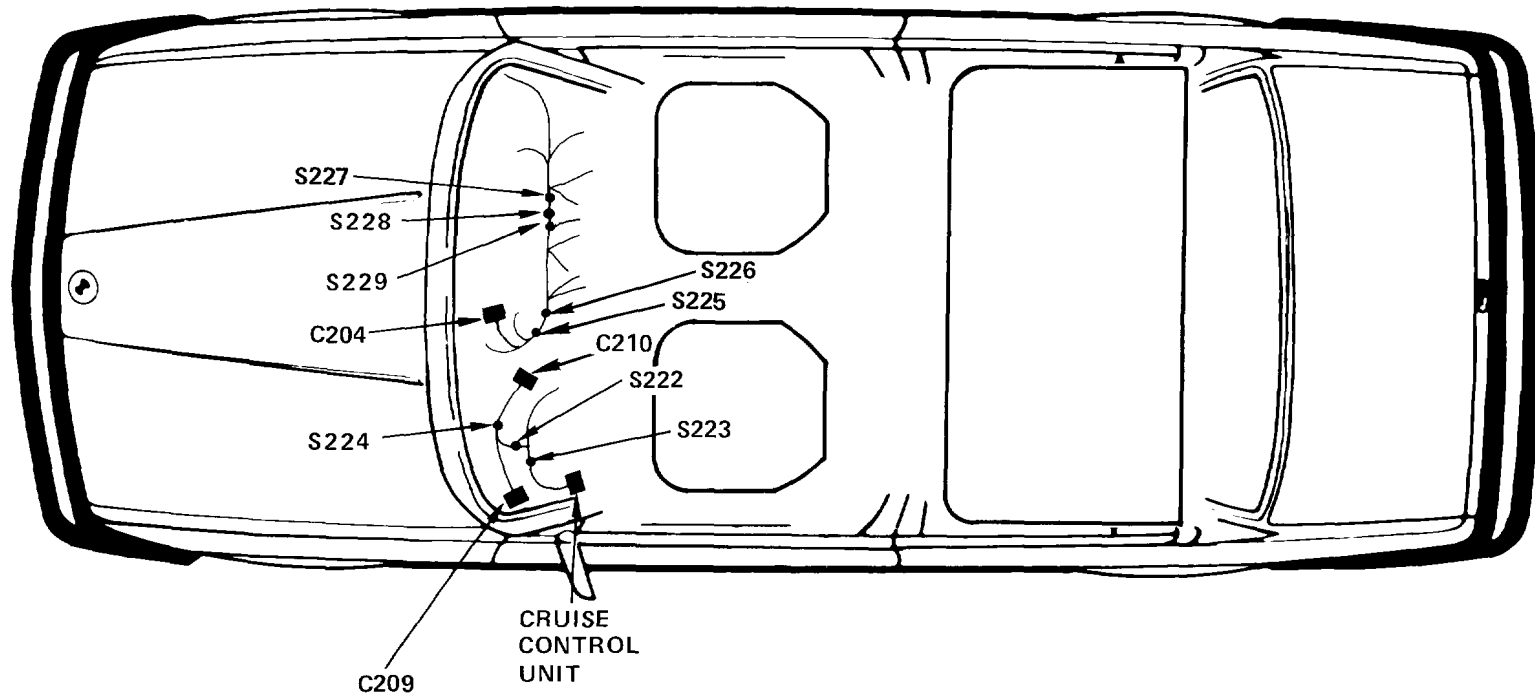

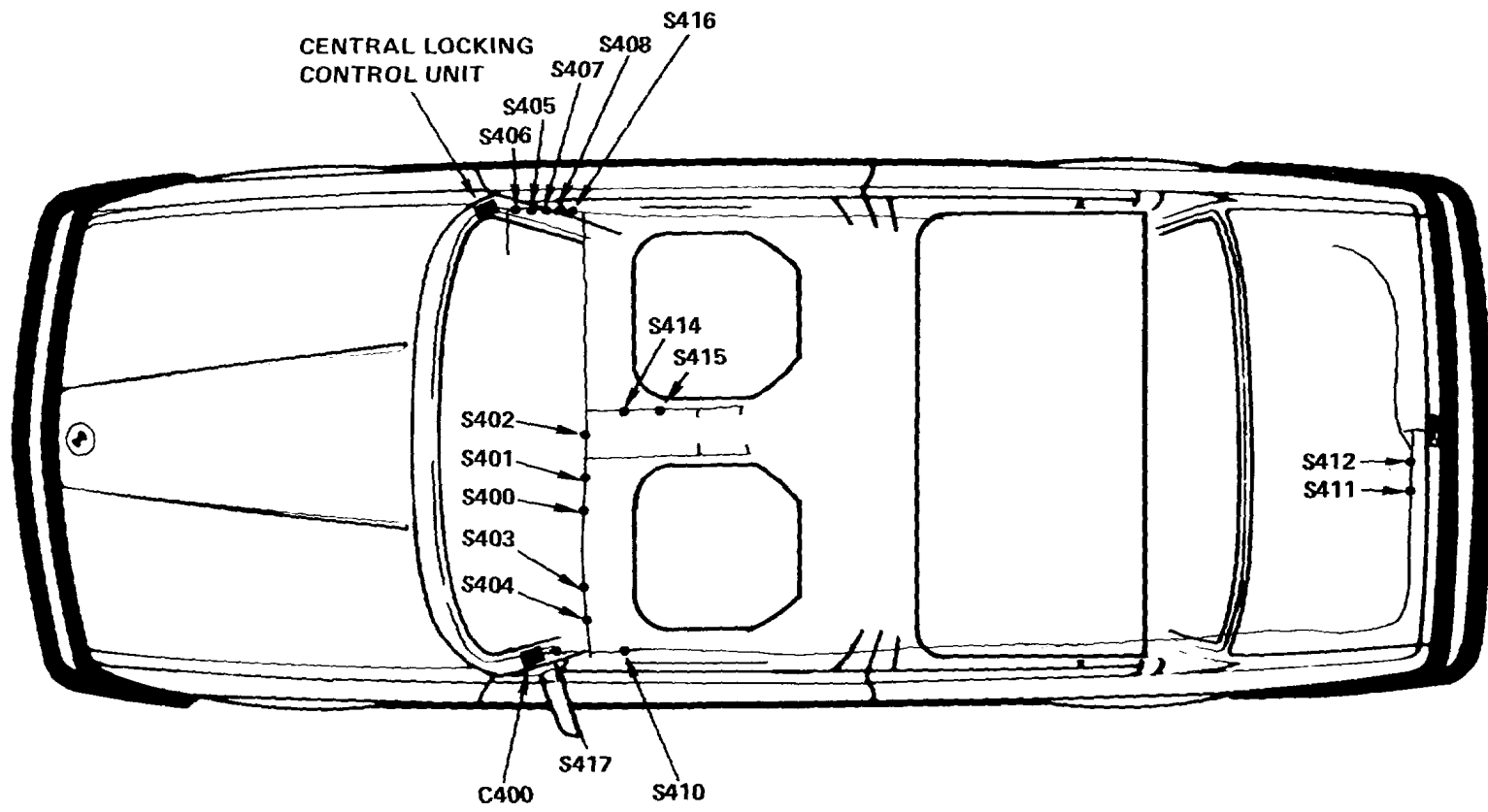

DOOR HARNESS

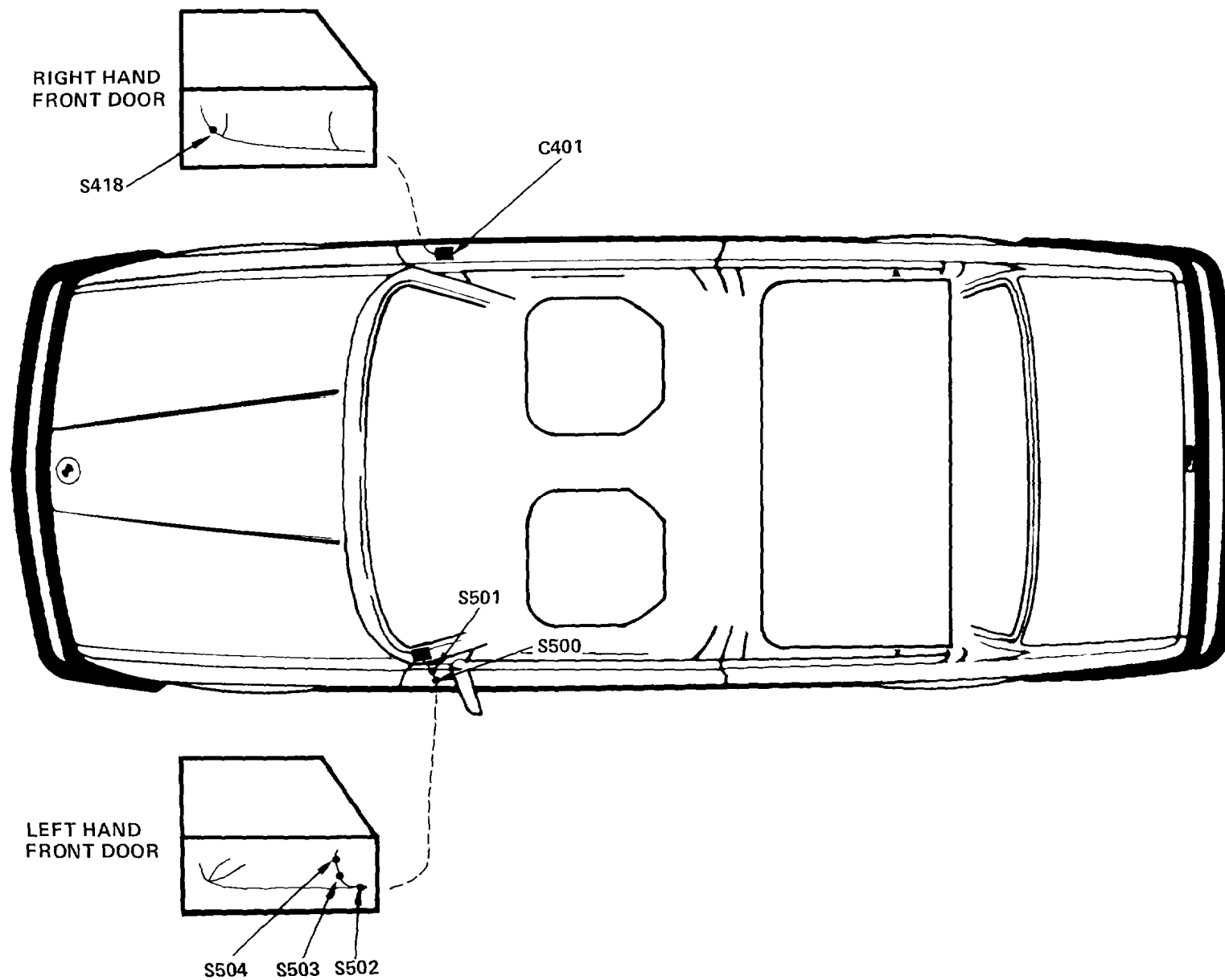

DIAGNOSTIC CONNECTOR

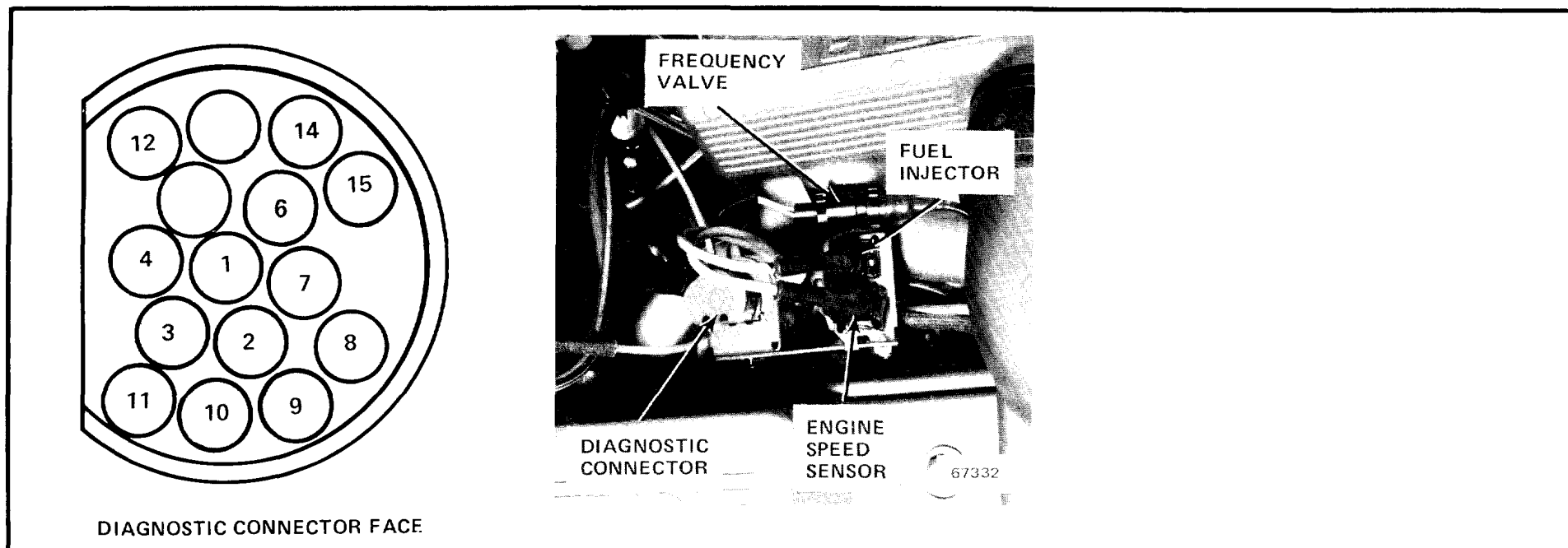

Figure 1 - Top Of Engine

PIN	WIRE SIZE	WIRE COLOR	CIRCUIT AND COMPONENT CONNECTED
1	2.5	BR	Ground Distribution, G103.
2	.5	YL	Fuel Control, Fuel Injector.
3	.5	BK	Fuel Control, Fuel Injector.
4	.75	BR/WT	Gauges/Warning Indicators, Coolant Temperature Sender.
6	.75	WT/BK	Not Used.
7	.75	WT/BU	Service Interval Indicator, Service Interval Processor (Reset).
8	.5	YL	Fuel Delivery, TDC Sensor.
9		SHIELD	Fuel Delivery, TDC Sensor.
10	.5	BK	Fuel Delivery, TDC Sensor.
11	2.5	BK/YL	Start, Start Signal.
12	.75	BU	Charge System, Alternator.
14	2.5	RD	Charge System, Alternator.
15	2.5	GN	Evaporative Control, Main Relay.

ACCESSORY CONNECTOR

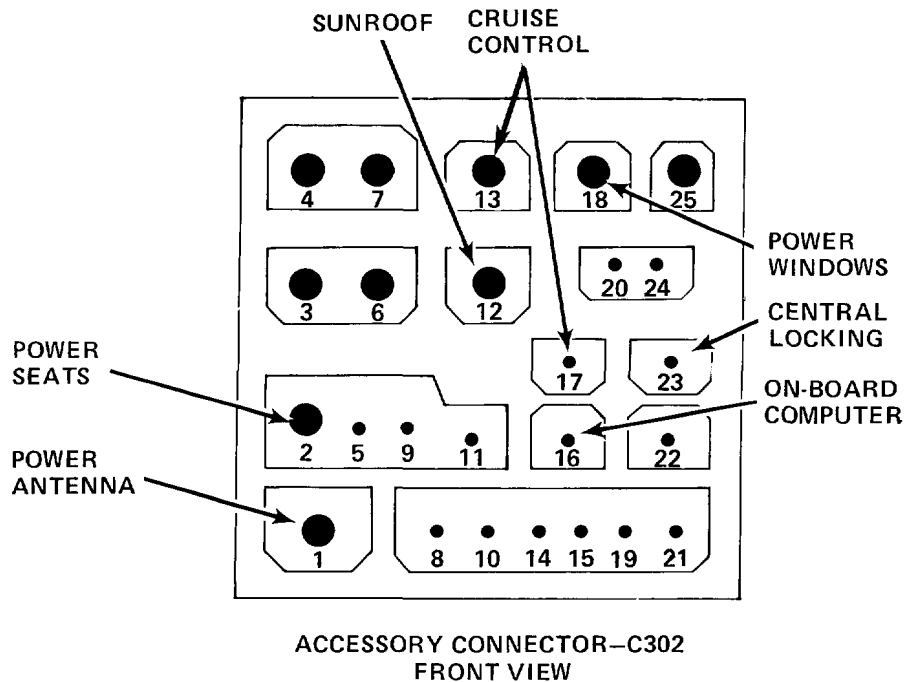
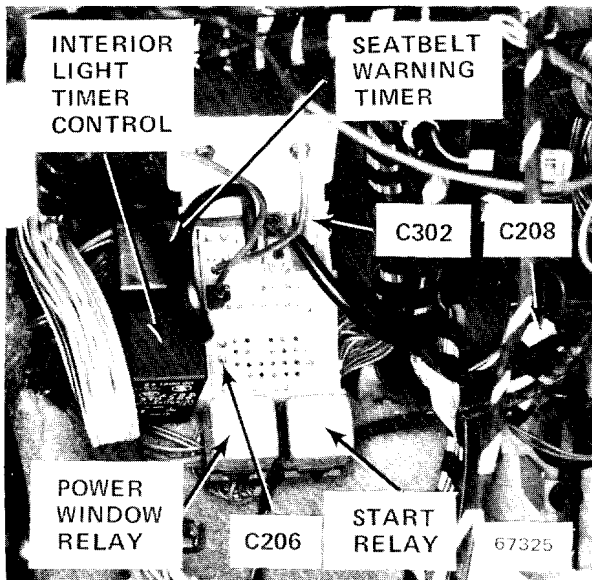
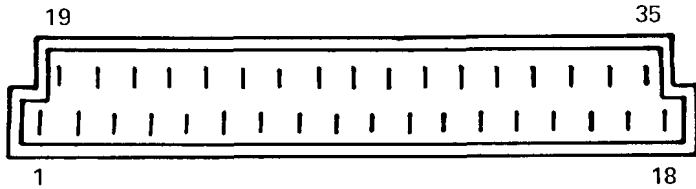
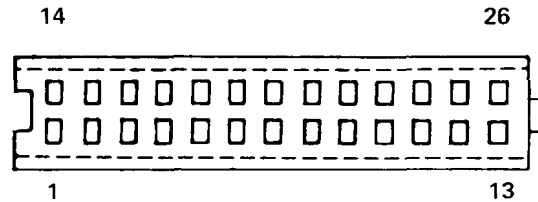

Figure 1 - Under Left Side Of Dash



Wiring Face
ABS ELECTRONIC CONTROL UNIT



Wiring Face
ACTIVE CHECK CONTROL UNIT

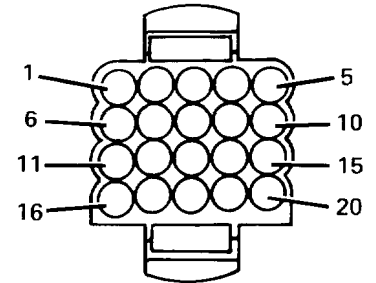

Wiring Face
AMPLIFIER

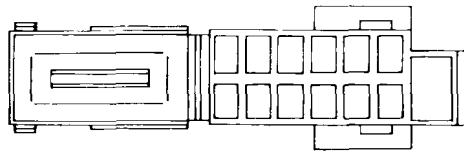

Wiring Face
ABS HYDRAULIC UNIT

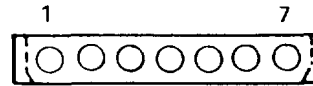

Wiring Face
AIR DOOR CONTROL

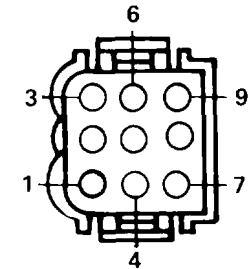

Wiring Face
AUTOMATIC TRANSMISSION RANGE SWITCH

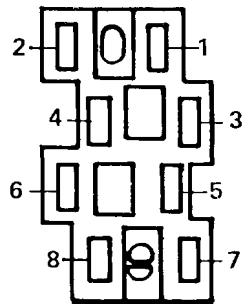

Mating Face
A/C SELECTOR SWITCH

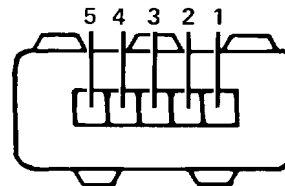

Mating Face
AIR FLOW METER

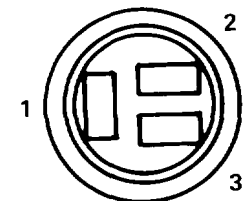

Wiring Face
AUXILIARY FAN

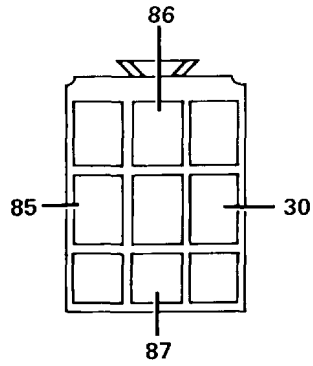

Wiring Face
AUXILIARY FAN RELAY

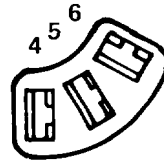

Wiring Face
BLOWER SPEED SWITCH (C2)

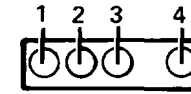

Wiring Face
CHIME MODULE (C2)

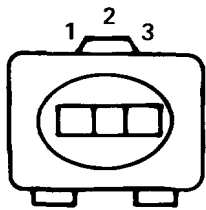

Wiring Face
BAROMETRIC PRESSURE SENSOR

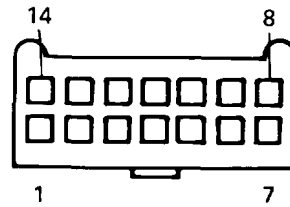

Wiring Face
CENTRAL LOCKING CONTROL UNIT

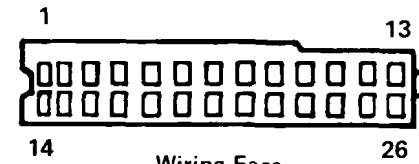

Wiring Face
CRUISE CONTROL

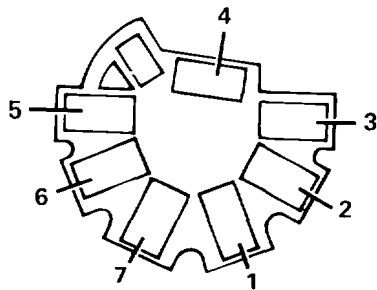

Wiring Face
BLOWER SPEED SWITCH

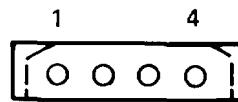

Wiring Face
CHIME MODULE (C1)

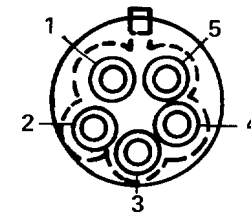

Wiring Face
DASH WARNING DISPLAY

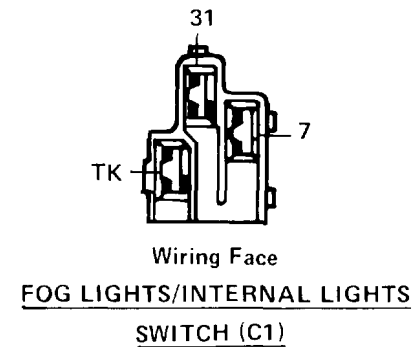
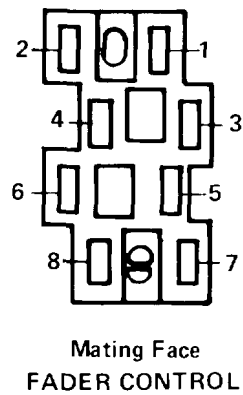
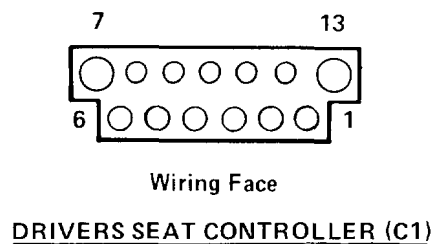
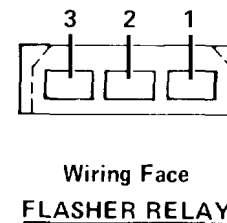
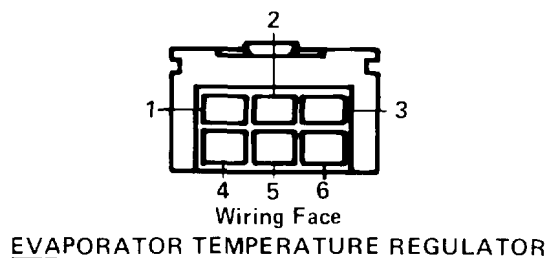
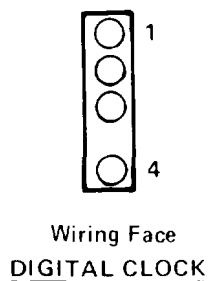
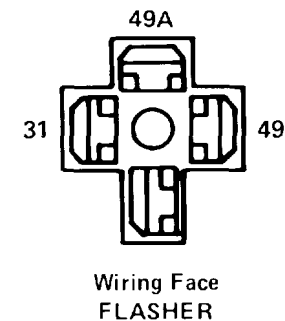
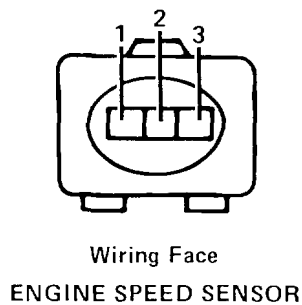
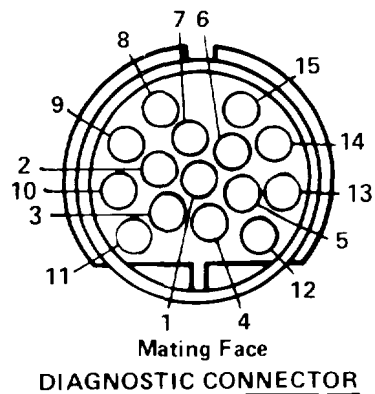

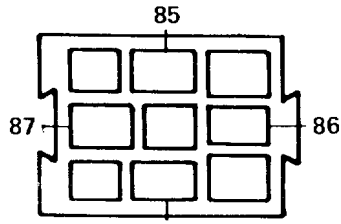

Wiring Face
FUEL HEATER RELAY

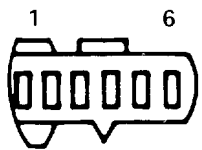

Wiring Face
GAS FILLER LOCK MOTOR

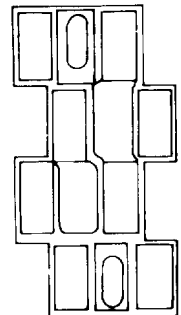

Wiring Face
HAZARD SWITCH

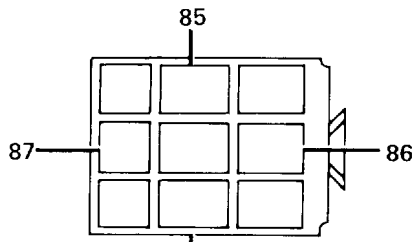

Wiring Face
FUEL PUMP RELAY

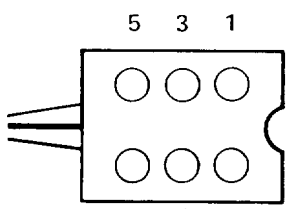

Wiring Face
GLOW PLUG MODULE (C1)

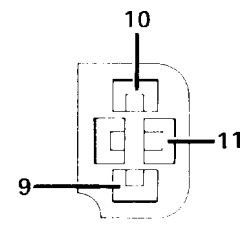

Wiring Face
HEADREST CONTROL SWITCH

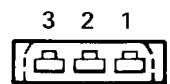

Wiring Face
FUEL TANK SENDER

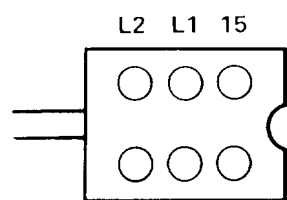

NTC 31 50
Wiring Face
GLOW PLUG MODULE (C2)

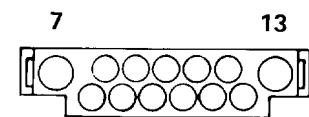

Wiring Face
HEATER CONTROL

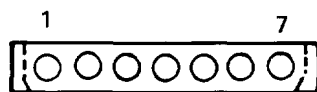

Wiring Face
HEATER REGULATOR

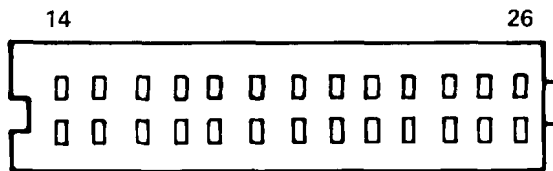

Wiring Face
INSTRUMENT CLUSTER

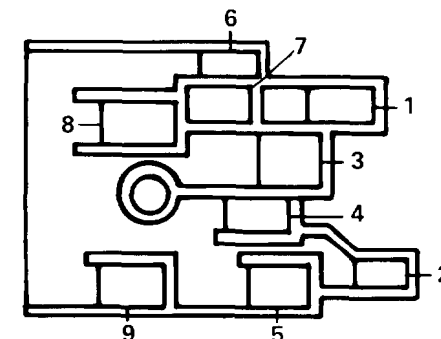

Wiring Face
LIGHT SWITCH

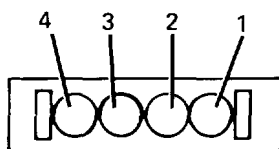

Wiring Face
HIGH LEVEL STOP LIGHT

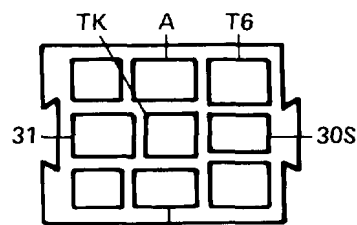

Wiring Face
INTERIOR LIGHT TIMER CONTROL

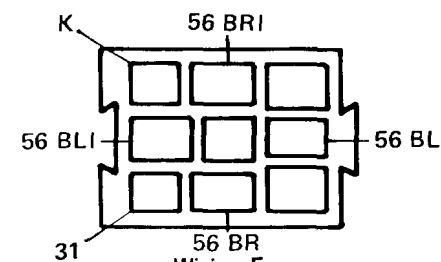

Wiring Face
LOW BEAM CHECK RELAY

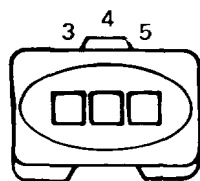

Wiring Face
IDLE SPEED ACTUATOR

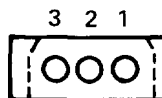

Wiring Face
INTERIOR TEMPERATURE SENSOR

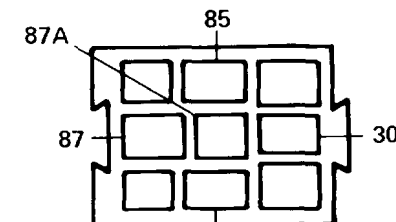

Wiring Face
MAIN RELAY

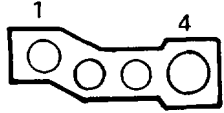

Wiring Face
MEMORY SEAT ACCESSORY
CONNECTOR (C302)

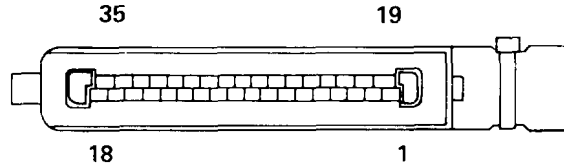

Mating Face
TIMING CONTROL UNIT

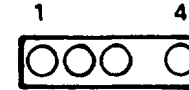

Wiring Face
ON BOARD COMPUTER
RELAY BOX (C1)

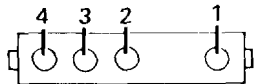

Wiring Face
MIRROR

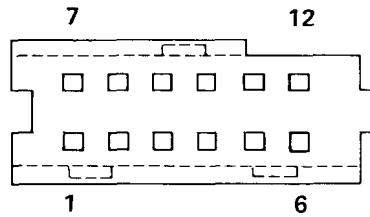

Wiring Face
MULTI-FUNCTION CLOCK
 (524TD only)

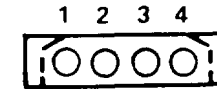

Wiring Face
ON BOARD COMPUTER
RELAY BOX (C2)



Wiring Face
MIRROR CONTROL SWITCH

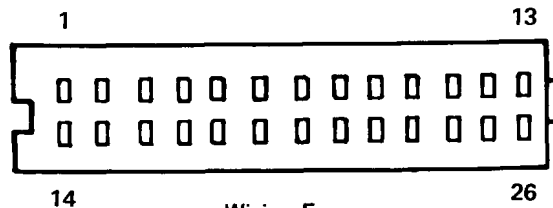

Wiring Face
ON BOARD COMPUTER MODULE

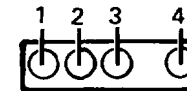

Wiring Face
OUTSIDE MIRROR

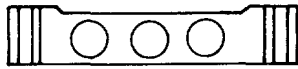

Wiring Face
POTENTIOMETER

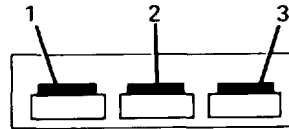

Wiring Face
PROGRAM SWITCH (C2)

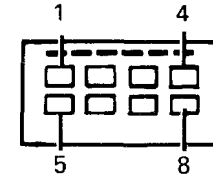

Wiring Face
REAR LIGHTS CHECK RELAY

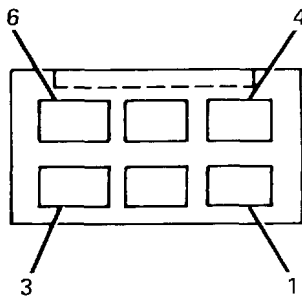

Wiring Face
POWER SEAT CONTROL UNIT (C2)

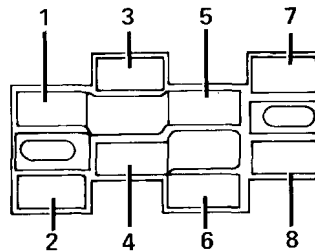

Wiring Face
REAR DEFOGGER

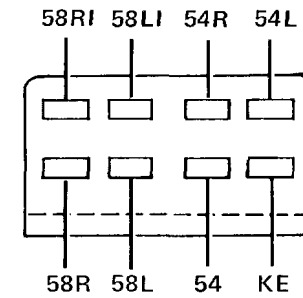

Wiring Face
REAR LIGHTS CHECK RELAY (C1)

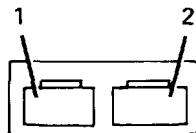

Wiring Face
PROGRAM SWITCH (C1)

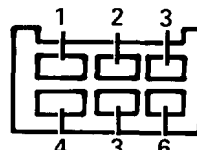

Wiring Face
REAR LIGHT ASSEMBLY

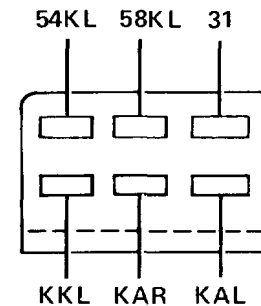

Wiring Face
REAR CHECK LIGHTS CHECK RELAY (C2)

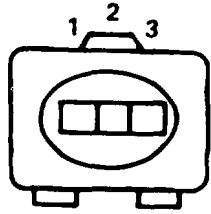

Wiring Face
REFERENCE POINT SENSOR

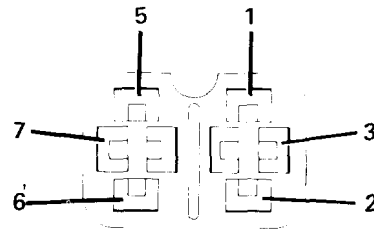

Wiring Face
SEAT SWITCHES FRONT
& REAR HEIGHT

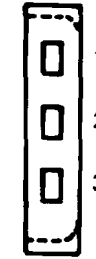

Wiring Face
SUNROOF MOTOR (CI)

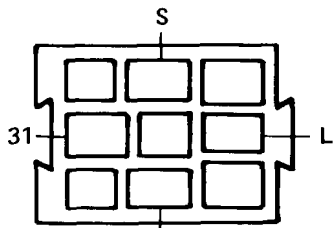

Wiring Face
SEAT BELT WARNING TIMER

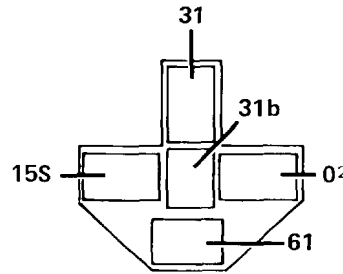

Wiring Face
SERVICE REMINDER SWITCH

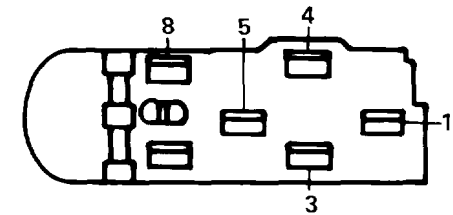

Wiring Face
SUNROOF SWITCH

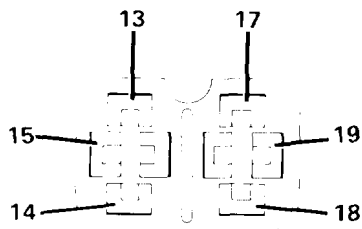

Wiring Face
SEAT SWITCHES BACK
& SEAT CUSHIONS

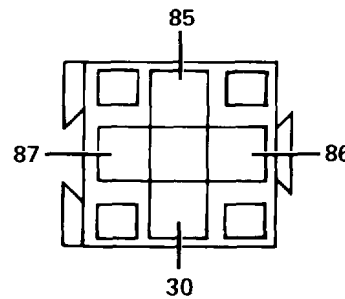

Wiring Face
START RELAY

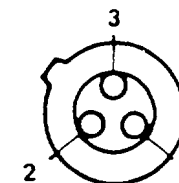

Wiring Face
THROTTLE POSITION SENSOR

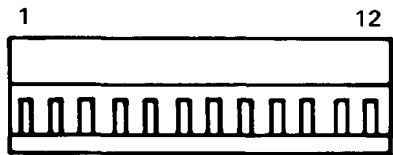

Wiring Face
TRANSMISSION RANGE DISPLAY

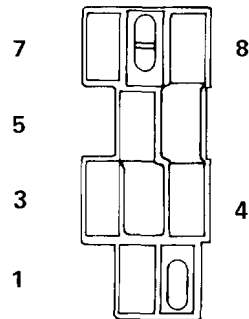

Wiring Face
WINDOW SWITCHES



Wiring Face
C103
(528e only)

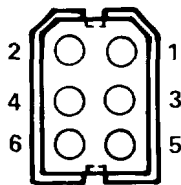

Wiring Face
WIPER MOTOR

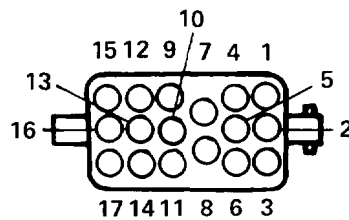

Wiring Face
C101

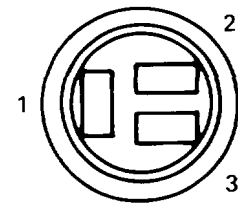

Wiring Face
C113



Wiring Face
WIPER SWITCH

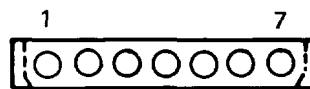

Wiring Face
C102



Wiring Face
C114

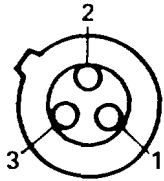

Wiring Face
C141

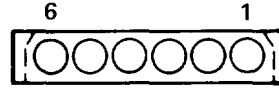

Wiring Face
C201

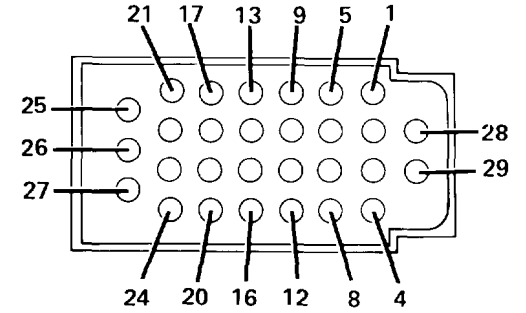

Wiring Face
C206

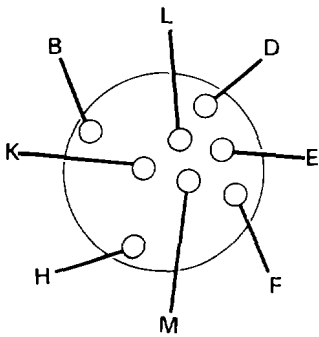

Wiring Face
C152

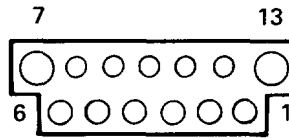

Wiring Face
C202

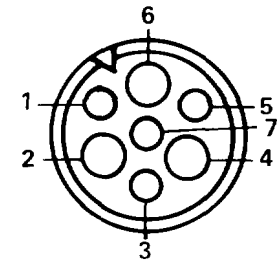

Wiring Face
C209

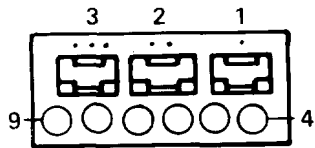

Wiring Face
C200

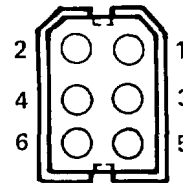

Wiring Face
C205

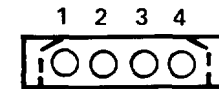

Wiring Face
C210

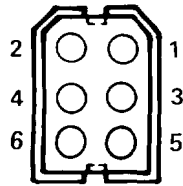

Wiring Face
C214

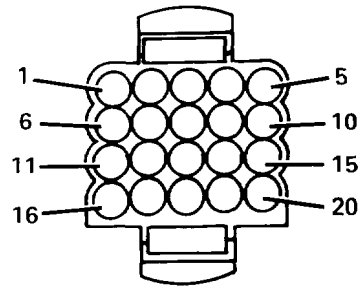

Wiring Face
C320

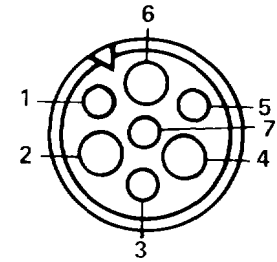

Wiring Face
C402

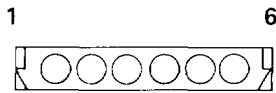

Wiring Face
C240

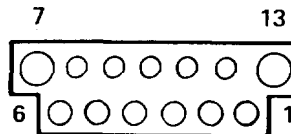

Wiring Face
C400

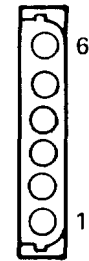

Wiring Face
C500

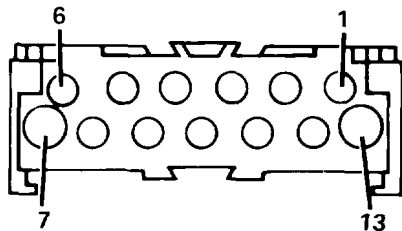

Wiring Face
C250

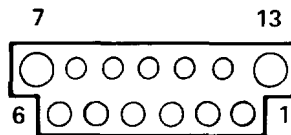

Wiring Face
C401

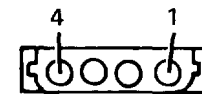

Wiring Face
C501

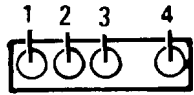

Wiring Face
C502

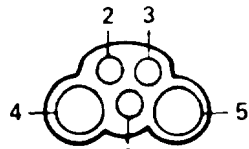

Wiring Face
C550

COMPONENTS

	Page-Figure
5.5 Degrees C Temperature Switch	LH front of engine, on fuel filter. 7000-0-6
A/C In-Line Diode	On RH side of A/C compressor 7000-2-2
ABS Electronic Control Unit	In glove box, above timing control unit 7000-5-6
ABS Hydraulic Unit	Ahead of RH front wheel well. 7000-2-1
Active Check Control Unit	Above rear view mirror
Amplifier	In trunk, near LH wheel well
Auto-Charging Flashlight.	In glove box
Auto. Trans. Range Switch.	At base of shift lever. 7000-7-1
Auxiliary Fan In-Line Diode.	Inside front harness, behind RH headlights
Auxiliary Fan Motor.	Forward of radiator. 7000-1-1
Auxiliary Fuses.	On LH wheel well, beside power distribution box 7000-0-3
Backup Light Switch	On LH side of transmission
Blower Speed Switch	In center console
Brake Fluid Level Switch	LH rear of engine, on brake fluid reservoir 7000-3-1
Brake Switch.	Above brake pedal 7000-5-2
Central Locking Control Unit.	Above right front speaker. 7000-8-5
Chime Module	Mounted on left, under dash cover. 7000-5-5
Clutch Switch	Above clutch pedal
Combination Switch	On LH side of steering column 7000-5-1
Compressor Clutch	On front of A/C compressor
Coolant Level Switch	On LH front wheel well, in coolant reservoir 7000-2-3
Coolant Temperature Sender	Front of engine, on thermostat housing 7000-2-6
Coolant Temperature Switch	LH side of engine, rear of *5 glow plug 7000-1-3
Cruise Control Actuator	On LH front wheel well, near shock tower 7000-3-3
Cruise Control Control Unit	Mounted on left, under dash cover 7000-3-5
Cruise Control Switch.	On RH side of steering column 7000-3-4
Diagnostic Connector	Top rear of engine 7000-1-2
Driver's Door Lock Motor	In LH front door 7000-6-6
Driver's Seat Controller	Under driver's seat, on frame 7000-7-2
EGR Micro Switch	LH front of engine, on fuel injection pump 7000-2-6
EGR Valve	On bulkhead, above brake vacuum booster 7000-3-2
Engine Speed Sensor.	LH rear of engine, below starter. 7000-1-2
Evaporator Blower Motor.	Under center of dash. 7000-4-2
Evaporator Blower Resistors	On RH side of upper console. 7000-4-2
Evaporator Temp. Regulator	On LH side of heater/evaporator housing 7000-3-6
Evaporator Temp. Sensor	In evaporator, above evaporator blower motor
Fader Control	In upper part of center console. 7000-3-6
Flasher	Upper part of steering column 7000-4-3
Frequency Valve	Lower LH front of engine

COMPONENTS		Page-Figure
Fuel Heater	LH front of engine, on fuel filter	7000-0-6
Fuel Heater Relay	On power distribution box	7000-0-2
Fuel Injector	Top rear of engine, near diagnostic connector	7000-1-2
Fuel Pump	In fuel tank, under trunk	7000-7-5
Fuel Pump Relay	On power distribution box	7000-0-2
Fuel Shutoff Valve	LH front of engine, on fuel injection pump	7000-2-4
Fuel Tank Sender	Under trunk, top RH side of fuel tank	7000-7-5
Gas Filler Lock Motor	In trunk, right of power antenna	7000-7-4
Glow Plug Control Module	On LH front wheel well, near power distribution box	7000-0-3
Glow Plugs	In LH side of engine, at each cylinder	7000-2-6
Hazard Switch	To right of instrument cluster	
Heater Blower Motor	Below windshield, behind cover panel	
Heater Blower Resistors	Below heater cover motor	
Heater Regulator	Behind A/C selector switch	7000-3-6
Heater Temperature Sensor	LH side of heater/evaporator, near heater core	7000-3-6
High Pressure Cut-Out Switch	On receiver-drier, behind RH headlights	7000-2-1
High Speed Cool. Temp. Switch	On lower RH side of radiator (red terminals)	7000-1-6
High Speed Relay	Attached to power distribution box	7000-0-4
Horn Brush/Slip Ring	Below hub of steering wheel	
Horn Switches	In each spoke on steering wheel	
Ignition Key Switch	In upper portion of steering column	7000-3-4
Ignition Switch	Upper part of steering column	7000-3-4
Interior Light Timer Control	Under LH side of dash	7000-4-4
Interior Temp. Sensor	Mounted in left, under dash cover	7000-4-1
LH Front Brake Wear Sensor	Near caliper, connected to brake pad	7000-7-6
LH Rear Door Lock Motor	In LH rear door	7000-6-6
Lock Heater	In LH front door	7000-6-6
Lock Heater Control Unit	In LH front door	7000-6-6
Low Beam Check Relay	Attached to power distribution box	7000-0-4
Main Relay	On power distribution box	7000-0-3
Manifold Pressure Switch	LH side of engine, under air intake manifold	7000-2-4
Mirror Control Switch	On driver's door	
Motor Relay	Behind header, above rear view mirror	
Normal Speed Blower Resistor	Ahead of radiator, on auxiliary fan shield	7000-2-5
Normal Speed Cool. Temp. Switch	On lower RH side of radiator (white terminals)	7000-1-6
Normal Speed Relay	Attached to power distribution box	7000-0-4
Oil Level Sensor	Bottom of engine oil pan	7000-8-4
Oil Pressure Switch	Behind air cleaner, on top of oil filter	7000-1-5
Parking Brake Switch	In shift console, at base of parking brake	

COMPONENTS

		Page-Figure
Passenger's Seat Controller	Under passenger's seat, on frame	
Power Distribution Box	On LH front wheel well	7000-0-2
Power Window Circuit Brkr.	Mounted in left, under dash cover	7000-6-5
Power Window Relay	Under LH side of dash	7000-4-4
Pulse Wheels	Inner side of brake rotors	
Rear Lights Check Relay	Mounted on trunk lock support	7000-7-3
RH Front Door Lock Motor	In RH front door	7000-6-6
RH Rear Brake Wear Sensor	Near caliper, connected to brake pad	7000-7-6
RH Rear Door Lock Motor	In RH rear door	7000-6-6
Right Front Door Micro Switch	Inside door, on door lock	
Safety Switch	On shift console	7000-6-4
Seatbelt Switch	In driver's seatbelt buckle	
Seatbelt Warning Timer	Under LH side of dash	7000-4-5
Speed Detectors	Inside of wheel, on dust shield	7000-8-1
Speedometer Sender	In rear of differential	7000-8-2
SRS Safety Switch	On LH wheel well, near shock tower	7000-3-3
Start Relay	Under LH side of dash	7000-4-5
Starter	Lower rear LH side of engine	
Sunroof Motor	Behind header, above rear view mirror	
Sunroof Switch	Above rear view mirror	
TDC Sensor	In LH side of bell housing	7000-8-3
Timing Control Unit	Above glove box	7000-5-6
Trunk Light Switch	In trunk lid, near trunk lock	
Trunk Lock Motor	In rear panel of trunk	7000-7-3
Unlock Inhibit Switch	In LH door, near door lock cylinder	
Washer Fluid Level Switch	In reservoir, behind LH headlights	7000-0-5
Washer Jet Heaters	On washer jet nozzles	
Washer Pump	Behind LH headlights, in reservoir	7000-0-5
Water In Fuel Sensor	Ahead of LH front wheel well, under fuel filter	7000-0-6
Water Shut-Off Valve	Below brake master cylinder	7000-3-1
Window Console Switches	On shift console	7000-6-4
Window Motors	In each door	7000-6-3
Wiper Motor	Above brake master cylinder	
Wiper/Washer Switch	On RH side of steering column	7000-3-4

CONNECTORS

110 Degrees C Temperature Switch	On top of A/C compressor, near rear	7000-2-2
78 Degrees C Temperature Switch	LH side of engine, rear of *4 glow plug	7000-1-3
C101 (17 pin)	In power distribution box	7000-0-2
C102 (7 pin)	In power distribution box	7000-0-1

CONNECTORS

Page-Figure

C105 (1 pin)	On RH wheel well, near shock tower	7000-1-4
C106 (1 pin)	Near RH wheel well, under air cleaner	7000-2-2
C107 (2 pin)	Behind LH headlights	
C108 (2 pin)	Behind RH headlights	
C110 (2 pin)	Near washer pump	7000-0-5
C112 (2 pin)	Top rear of engine, LH side of valve cover	7000-1-2
C113 (3 pin)	Below LH headlights	
C200 (10 pin)	On LH side of steering column	7000-3-5
C201 (6 pin)	On LH side of steering column	7000-3-5
C202 (13 pin)	On LH side of steering column	7000-3-5
C204 (13 pin)	On LH side of heater/evaporator housing	7000-3-6
C206 (29 pin)	On connector bracket, under LH side of dash	7000-4-4
C208 (2 pin)	Near clutch pedal	7000-4-5
C209 (7 pin)	Near LH side of steering column	7000-5-2
C210 (4 pin)	On LH side of steering column	7000-3-5
C211 (1 pin)	Under LH side of dash	
C212 (1 pin)	Under LH side of dash, taped to harness	
C213	Under LH side of dash, near LH side of steering column	7000-4-1
C214 (6 pin)	Behind center of dash, near heater blower	
C215 (2 pin)	Behind radio	7000-5-4
C216 (2 pin)	Behind radio	
C219 (2 pin)	RH side of trunk, near power antenna	7000-7-4
C240 (6 pin)	Above glove box, near timing control unit.	7000-5-6
C250 (13 pin)	In passenger compartment, under center of rear seat . .	7000-6-2
C300 (2 pin)	Near trunk light	
C301 (2 pin)	In center console, ahead of shift lever	
C302 (Accessory Connector)	Under LH side of dash	7000-4-6
C303 (2 pin)	In headliner, near LH dome light	
C320 (20 pin)	In trunk, near amplifier	
C400 (13 pin)	Behind LH front speaker	7000-5-3
C401 (13 pin)	Behind RH front speaker	7000-8-5
C402 (7 pin)	In LH B pillar	
C403 (7 pin)	In RH B pillar	
C404 (5 pin)	Under LH side of dash, against kick panel	7000-4-6
C405 (2 pin)	In trunk, near trunk lock	
C500 (6 pin)	Behind LH front speaker	7000-5-3
C501 (4 pin)	Behind LH front speaker	7000-5-3
C502 (4 pin)	Behind RH front speaker	7000-8-5