



---

**1983**

---

**BMW 733i**

---

**Electrical**

---

**Troubleshooting**

---

**Manual**

---

BMW of North America, Inc.  
Montvale, New Jersey

## FOREWORD

In the interests of continuing technical development work we reserve the right to modify designs and equipment.

Printed in USA

© Copyright BMW of North America, Inc.  
January 1983

Not to be reproduced wholly or in part  
without written permission of  
BMW of North America, Inc.

PN 01 00 1 467 794

**1983  
BMW 733i  
Electrical  
Troubleshooting  
Manual**

**CONTENTS**

---

Index .....	2
How To Use This Manual .....	3
Symbols .....	4
Wire Size Conversion Chart ...	5
Systematic Troubleshooting ...	6
Diagnostic Connector .....	101
Power Distribution Box .....	102
Fuse Data .....	103
Schematic Diagrams .....	104
Component Charts and Figures .....	201

---

## Index—Alphabetical Listing of Electrical Circuits

	SCHEMATIC PAGE		SCHEMATIC PAGE
Accessory Connector .....	155	Lights (continued)	
Active Check Control .....	123	—Glove Box .....	140
Air Conditioning .....	149	—Hazard Warning .....	130
Auto-Charging Flashlight .....	140	—Headlights .....	128
Automatic Heater-Air Conditioner .....	149	—Interior .....	127
Auxiliary Fan .....	148	—License .....	133
Brake Lining Warning .....	126	—Rear Marker .....	133
Central Locking .....	144	—Stoplights .....	134
Charging System .....	109	—Tail .....	133
Cigar Lighter .....	140	—Turn .....	130
Cruise Control .....	134	—Transmission Range .....	136
Diagnostic Connector .....	101	—Trunk .....	133
Evaporative Control .....	111	—Visor .....	136
Fuel Control .....	114	—Underhood .....	132
Fuel Delivery .....	111	On-Board Computer .....	116
Fuel Gauge .....	119	Power Antenna .....	147
Fuse Data .....	103	Power Distribution .....	104
Gauges .....	118	Power Distribution Box .....	102
Ground Distribution .....	156	Power Mirrors .....	146
Heater .....	149	Power Windows .....	142
Heated Door Lock .....	154	Radio .....	147
Horn .....	154	Rear Defogger .....	141
Idle Speed Control .....	112	Seatbelt Warning .....	115
Ignition .....	113	Service Interval Indicator .....	121
Ignition Key Warning .....	115	Speedometer .....	118
Lights		Start .....	110
—Backup .....	139	Sunroof .....	141
—Center Console .....	138	Vacuum Pump .....	148
—Dash .....	136	Warning Indicators .....	118
—Fog .....	128	Windshield Washer Jet Heaters .....	161
—Front Park .....	132	Wiper/Washer .....	122

The purpose of this manual is to show electrical schematics in a manner that makes electrical troubleshooting easier. Electrical components which work together are shown together on one schematic. The Wiper-Washer schematic, for example, shows all of the electrical components in one diagram. At the top of the page is the fuse (positive) that powers the circuit. The flow of current is shown through all wires, connectors, switches, and motors to ground (negative) at the bottom of the page.

Within the schematic, all switches and sensors are shown "at rest," as though the Ignition Switch were off. For identification, component names are underlined and placed next to or above each component. Notes are included, describing how switches and other components work.

The power distribution schematic shows the current feed through all the connections from the Battery and Alternator to each fuse and the Ignition and Light Switches. If the Power Distribution schematic is combined with any other circuit schematic, a complete picture is made of how that circuit works. The Ground Distribution schematics show how several circuits are connected to common grounds.

All wiring between components is shown exactly as it exists in the vehicle; however, the wiring is not drawn to scale. To aid in understanding electrical operation, wiring inside complicated components has been simplified. The "Solid State" label designates electronic components.

WIRE SIZE CONVERSION CHART	
METRIC (CROSSSECTIONAL AREA IN MM <sup>2</sup> )	AWG (AMERICAN WIRE GAUGE)
.5	20
.75	18
1	16
1.5	14
2	14
2.5	12
4	10
6	8
8	8
16	4
20	4
25	2
32	2

WIRE INSULATION	
ABBREVIATIONS	COLOR
BK	BLACK
BR	BROWN
RD	RED
YL	YELLOW
GN	GREEN
BU	BLUE
VI	VIOLET
GY	GRAY
WT	WHITE
PK	PINK

# 4 SYMBOLS



ENTIRE COMPONENT SHOWN



PART OF A COMPONENT SHOWN

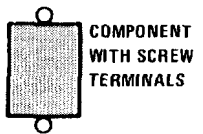

COMPONENT WITH SCREW TERMINALS

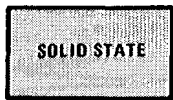

SOLID STATE (INCLUDES ONLY ELECTRONIC PARTS)

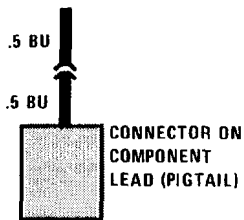

CONNECTOR ON COMPONENT LEAD (PIGTAIL)

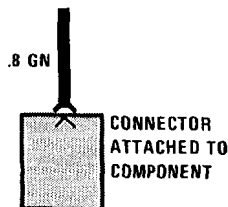

CONNECTOR ATTACHED TO COMPONENT

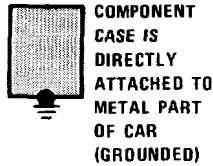

COMPONENT CASE IS DIRECTLY ATTACHED TO METAL PART OF CAR (GROUNDED)

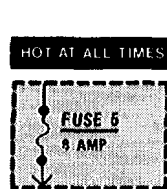

INDICATES THAT FUSE 5 IS ALWAYS SUPPLIED WITH POWER

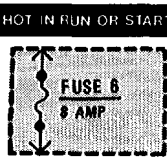

INDICATES THAT FUSE 6 IS SUPPLIED WITH POWER WITH THE IGNITION SWITCH IN THE RUN OR START POSITIONS

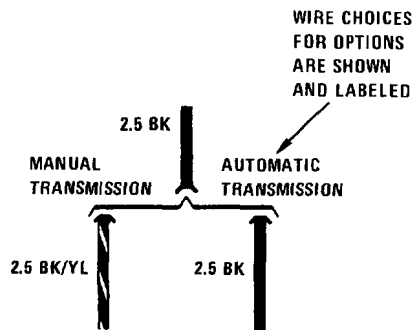

WIRE CHOICES FOR OPTIONS ARE SHOWN AND LABELED

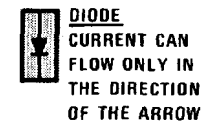
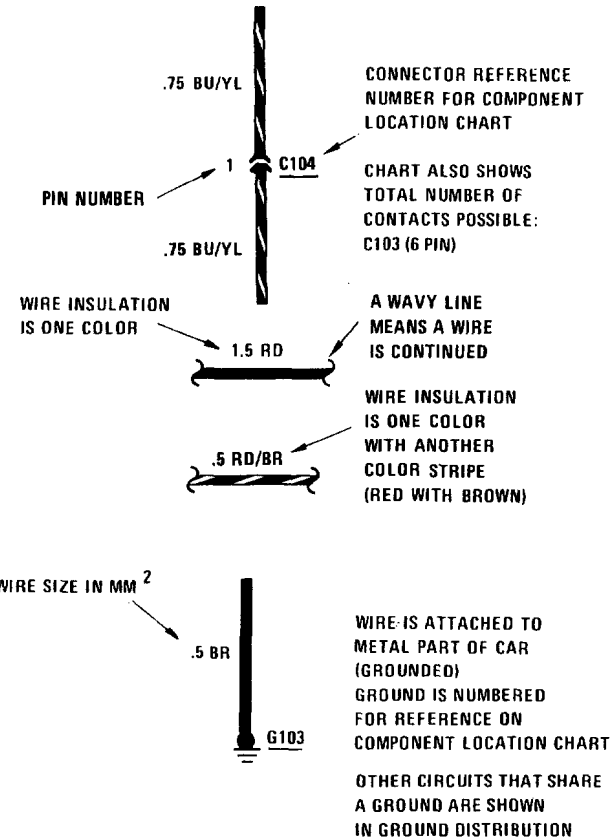

DIODE CURRENT CAN FLOW ONLY IN THE DIRECTION OF THE ARROW

CIRCUIT REFERENCE - A WIRE WHICH CONNECTS TO ANOTHER CIRCUIT



ACTIVE CHECK CONTROL

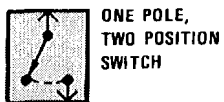

ONE POLE,  
TWO POSITION  
SWITCH

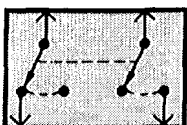

SWITCHES THAT  
MOVE TOGETHER  
DASHED LINE SHOWS  
A MECHANICAL  
CONNECTION  
BETWEEN SWITCHES

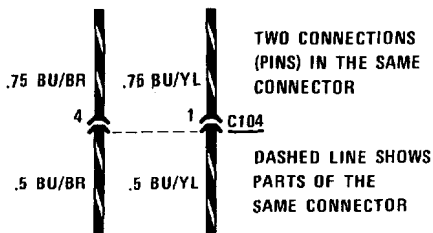

TWO CONNECTIONS  
(PINS) IN THE SAME  
CONNECTOR

DASHED LINE SHOWS  
PARTS OF THE  
SAME CONNECTOR



WHEN COIL IS  
ENERGIZED, SWITCH  
IS PULLED CLOSED

RELAY SHOWN  
WITH NO  
CURRENT  
FLOWING  
THROUGH  
COIL

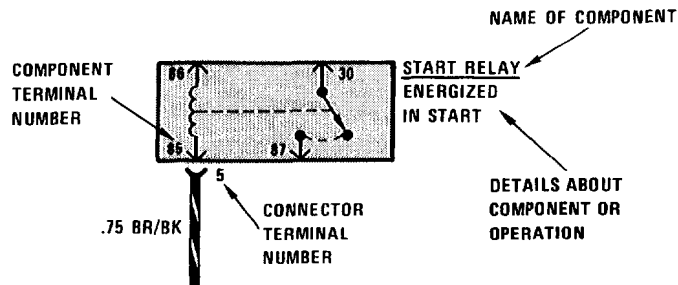

NAME OF COMPONENT

COMPONENT  
TERMINAL  
NUMBER

START RELAY  
ENERGIZED  
IN START

.75 BR/BK

CONNECTOR  
TERMINAL  
NUMBER

DETAILS ABOUT  
COMPONENT OR  
OPERATION

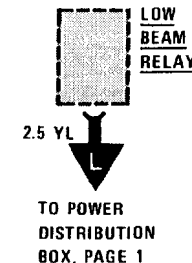

2.5 YL

TO POWER  
DISTRIBUTION  
BOX, PAGE 1

CURRENT PATH  
IS CONTINUED  
AS LABELED.  
THE ARROW SHOWS  
DIRECTION OF CURRENT  
FLOW AND IS REPEATED  
WHERE CURRENT  
PATH CONTINUES.

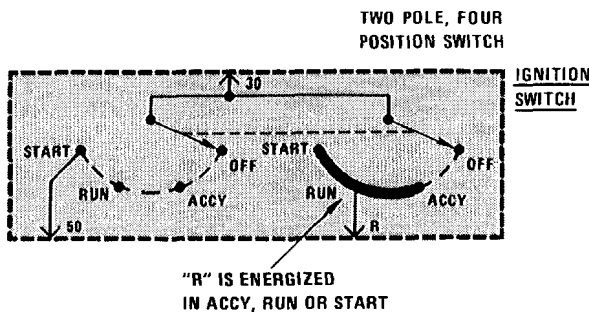

TWO POLE, FOUR  
POSITION SWITCH

IGNITION  
SWITCH

"R" IS ENERGIZED  
IN ACCY, RUN OR START

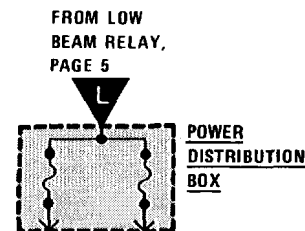

FROM LOW  
BEAM RELAY,  
PAGE 5

POWER  
DISTRIBUTION  
BOX

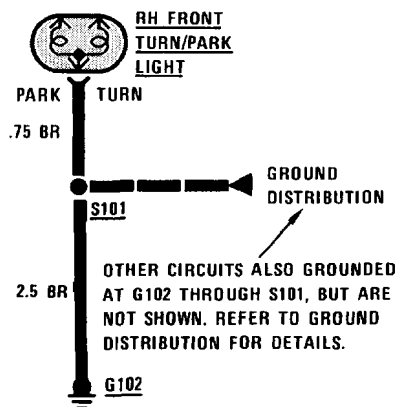

RH FRONT  
TURN/PARK  
LIGHT

PARK  
TURN  
.75 BR

GROUND  
DISTRIBUTION

S101  
2.5 BR

OTHER CIRCUITS ALSO GROUNDED  
AT G102 THROUGH S101, BUT ARE  
NOT SHOWN. REFER TO GROUND  
DISTRIBUTION FOR DETAILS.

G102



LIGHT  
EMITTING  
DIODE

## 6 SYSTEMATIC TROUBLESHOOTING

### TROUBLESHOOTING PROCEDURE

#### 1. Verify the Problem

Operate the problem circuit to check the accuracy of the complaint. Note the symptoms of the inoperative circuit.

#### 2. Analyze the Problem

Refer to the schematic of the problem circuit in the ETM. Determine how the circuit is supposed to work by tracing the current path(s) from the power feed through the circuit components to ground. Then based on the symptoms you noted in step 1 and your understanding of circuit operation, identify one or more possible causes of the problem.

#### 3. Isolate the Problem

Make circuit tests to prove or disprove the preliminary diagnosis made in step 2. Keep in mind that a logical simple procedure is the key to efficient troubleshooting. Test for the most likely cause of failure first. Try to make tests at points which are easily accessible.

#### 4. Repair the Problem

Once the specific problem is identified, make the repair using the proper tools and safe procedures.

#### 5. Check the Problem

Operate the circuit to check for satisfactory circuit operation. Good repair practice calls for rechecking all circuits you have worked on.

### TROUBLESHOOTING TOOLS

Isolating the problem (Step 3 of TROUBLESHOOTING PROCEDURES) requires the use of a **voltmeter** and/or **ohmmeter**. A voltmeter measures voltage at selected points in a circuit. An ohmmeter measures a circuit's resistance to current flow. It has an internal battery that provides current to the circuit under test. Disconnect the car battery when using an ohmmeter because the battery voltage will cause the ohmmeter to give false readings. Also, do not use an ohmmeter on solid-state components. The voltage that the ohmmeter applies to the circuit could damage these components.

### TROUBLESHOOTING TESTS

#### Voltage Test

This test measures voltage in a circuit. By taking measurements at several points (terminals or connectors) along the circuit, you can isolate the problem.

To take a voltage measurement, connect the negative lead of the voltmeter to the battery's negative terminal or other known good ground. Then connect the positive lead of the voltmeter to the point you want to test. The voltmeter will measure the voltage present at that point in the circuit.

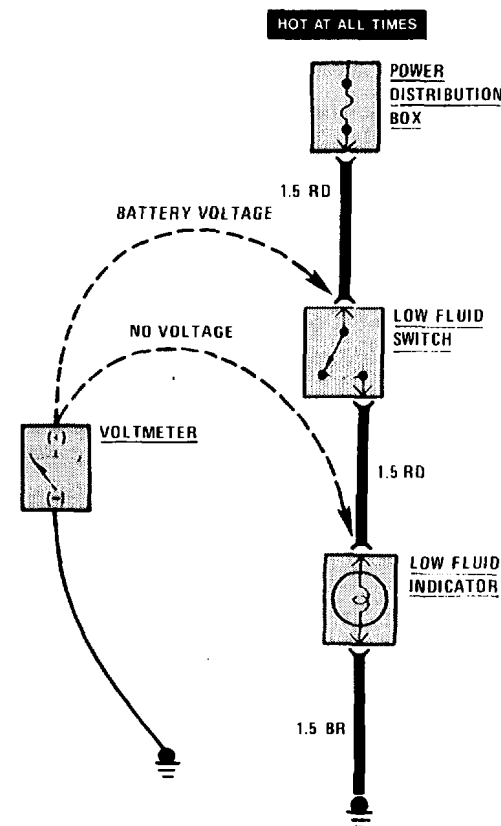

Voltage Test



Voltage Drop Test

Wires, connectors, and switches are designed to conduct current with a minimum loss of voltage. A voltage drop of more than one volt indicates a problem.

To test for voltage drop, connect the voltmeter leads to connectors at either end of the circuit's suspected problem area. The positive lead should be connected to the connector closest to the power source. The voltmeter will show the voltage drop between these two points.

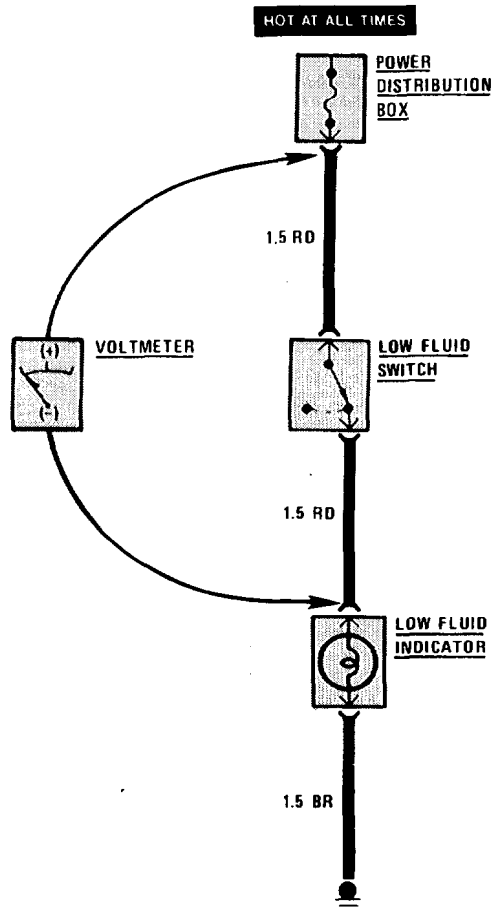

Voltage Drop Test

Continuity Test

To perform a continuity test, first disconnect the car battery. Then adjust the ohmmeter to read zero while holding the leads together. Connect the ohmmeter leads to connector or terminals at either end of the circuit's suspected problem area. The ohmmeter will show the resistance across that part of the circuit.

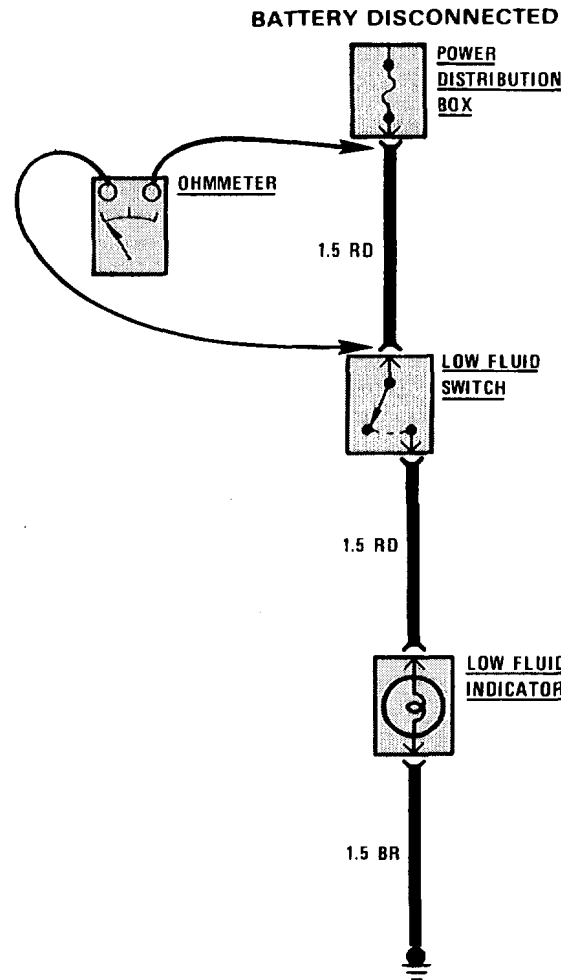

Continuity Test

Short Test Using Voltmeter

Remove the blown fuse and disconnect the load. Connect the voltmeter leads to the fuse terminals. The positive lead should be connected to the terminal closest to the power source.

Starting near the POWER DISTRIBUTION BOX, move the wire harness back and forth and watch the voltmeter reading. If the voltmeter registers a reading, there is a short to ground in the wiring. Somewhere in the area of the harness being moved, the wire insulation is worn away and the circuit is grounding.

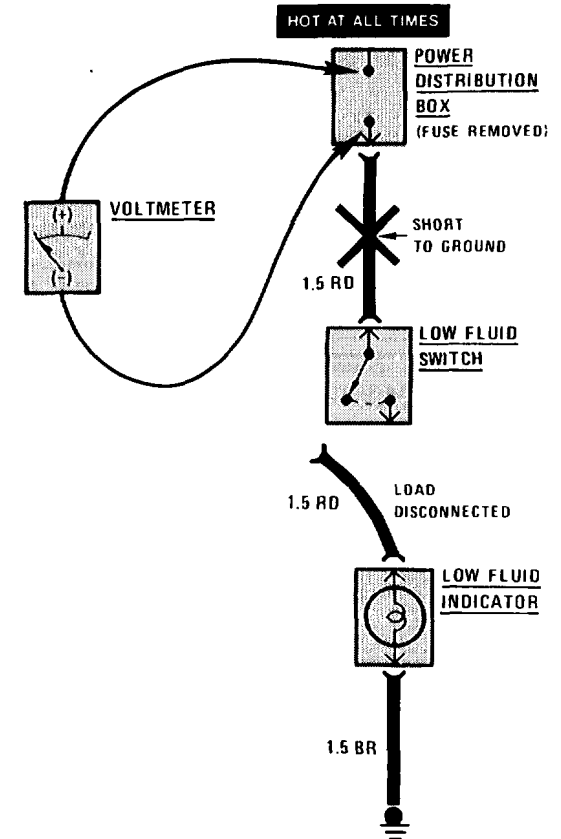

Short Test Using Voltmeter

## 8 SYSTEMATIC TROUBLESHOOTING

### Short Test Using Ohmmeter

Disconnect the battery. Adjust the ohmmeter to read zero while holding the leads together. Remove the blown fuse and disconnect the load. Connect one lead of the ohmmeter to the fuse terminal that is closest to the load. Connect the other lead to a known good ground.

Starting near the POWER DISTRIBUTION BOX, move the wire harness back and forth and watch the ohmmeter reading. Low or no resistance indicates a short to ground in the wiring. Infinitely high resistance indicates no short.

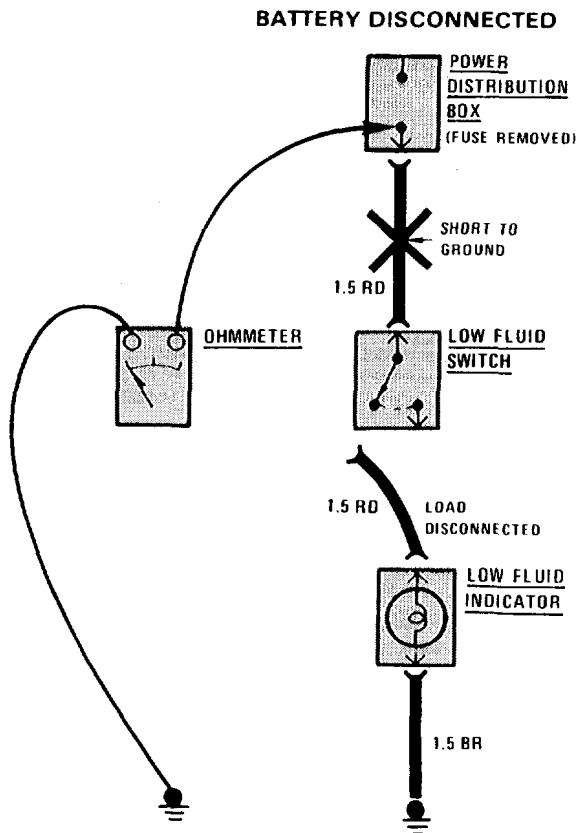

Short Test Using Ohmmeter

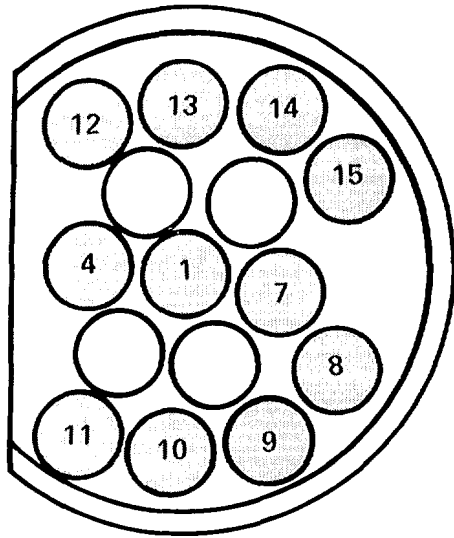

DIAGNOSTIC CONNECTOR FACE

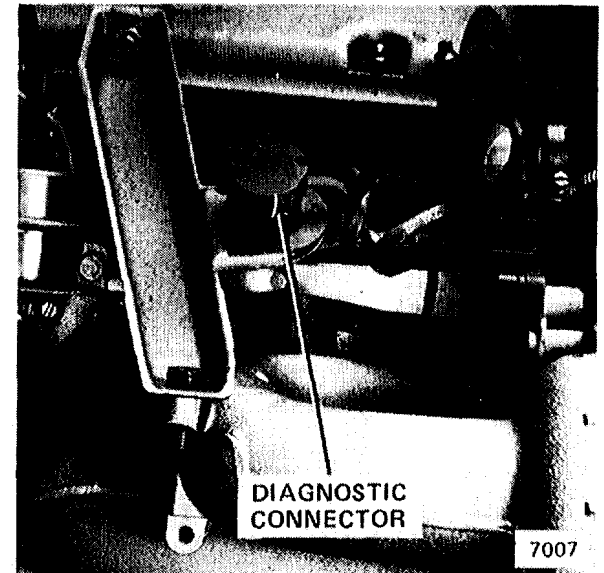
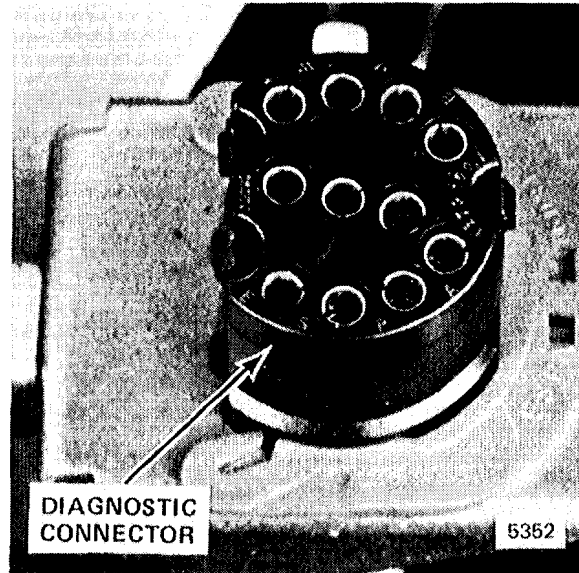

Figure 1 - Top Front of Engine

PIN	WIRE SIZE	WIRE COLOR	CIRCUIT AND COMPONENT CONNECTED
1	1.5	BR	Ground Distribution, G103
4	.5	BR/WT	Gauges/Warning Indicators, Coolant Temperature Sender.
7	.5		Service Interval Indicator, Service Interval Processor.
8	.5	YL	Ignition, TDC Sensor.
9		SHIELD	Ignition, TDC Sensor.
10	.5	BK	Ignition, TDC Sensor.
11	2.5	BK/YL	Start, Start Signal.
12	.75	BU	Charge System, Alternator.
13	.75	BK	Ignition, Ignition Coil.
14	2.5	RD	Charge System, Alternator.
15	1.5	GN/YL	Idle Speed Control, Idle Speed Control Unit.

# 102 POWER DISTRIBUTION BOX

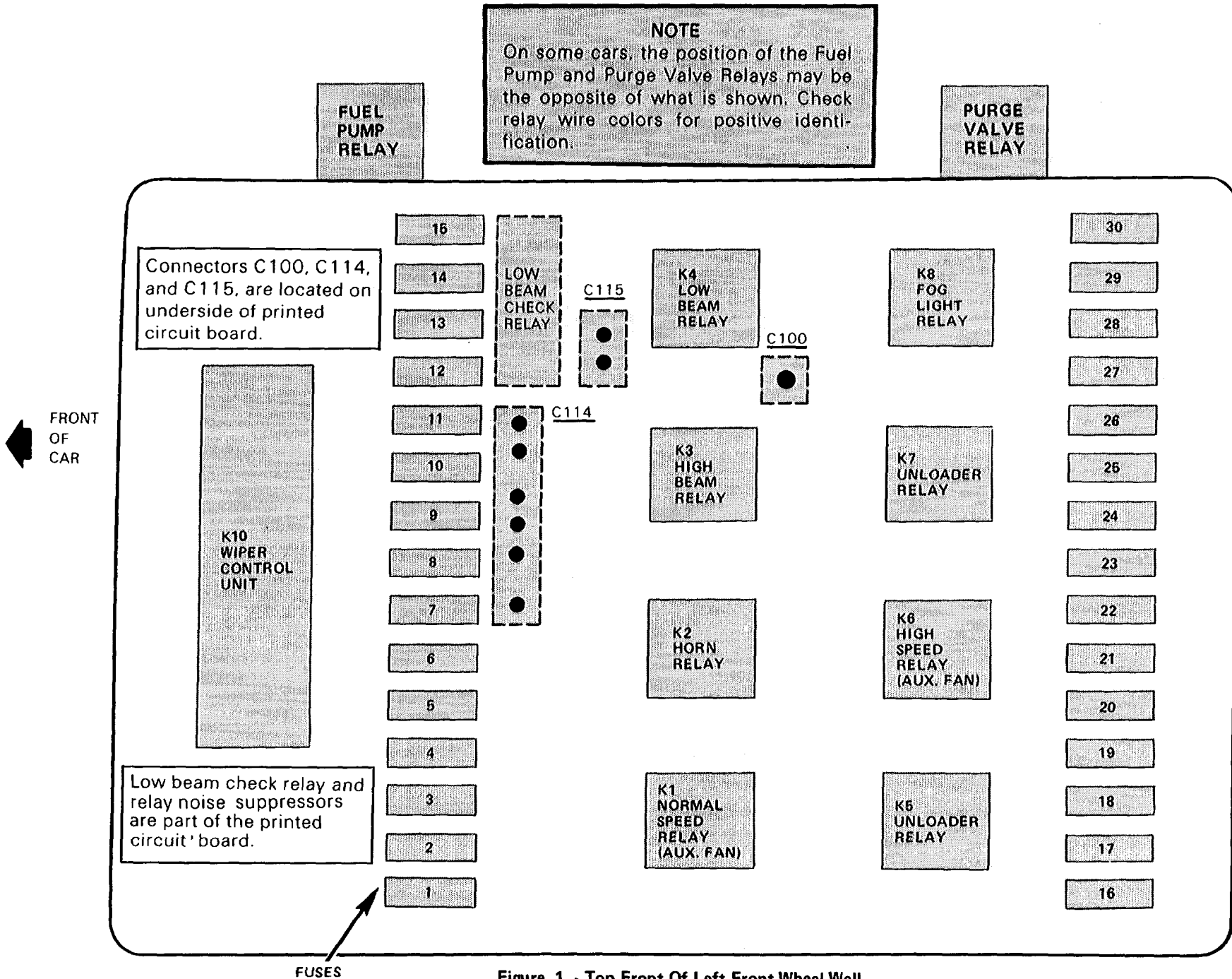

Figure 1 - Top Front Of Left Front Wheel Well

FUSE NO.	SIZE/ COLOR	CIRCUIT PROTECTED
1	15A (LT BU)	Headlights (also fuses 2, 13, 14).
2	15A (LT BU)	Headlights (also fuses 1, 13, 14).
3	15A (LT BU)	Auxiliary Fan (also fuses 16, 18).
4	15A (LT BU)	Lights: Turn/Hazard Warning (also fuse 24).
5	25A (WT)	Wiper/Washer.
6	7.5A (BR)	Active Check Control (also fuse 10, 12, 21, 22, 23); Stoplights/Cruise Control (also fuse 17).
7	15A (LT BU)	Horn.
8		Not Used.
9	15A (LT BU)	Idle Speed Cntrl (also fuse 17).
		Active Check Control (also fuses 6, 12, 21, 22, 23); Brake Linking Warning;
10	7.5A (BR)	On-Board Computer (also fuse 12, 21, 27); Service Interval Indicator (also fuse 21); Speedometer/Gauges/Warning Indicators (also fuses 12, 17, 21).
11	15A (LT BU)	Fuel Delivery.
12	7.5A (BR)	Active Check Control (also fuses 6, 10, 21, 22, 23); On-Board Computer (also fuses 10, 21, 27); Radio (also fuses 12, 28. Radio In-Line Fuse); Warning Indicators (also fuse 10).
13	7.5A (BR)	Headlights (also fuses 1, 2, 14).
14	7.5A (BR)	Headlights (also fuses 1, 2, 13).
15		Not Used.
16	30A (LT GRN)	Auxiliary Fan/Vacuum Pump (also fuses 3, 18); Heating/Air Conditioning.
17	15A (LT BU)	Back Up Lights; Idle Speed Control (also fuse 9); Interior Lights (also fuse 21); Power Mirrors; Power Windows (also fuse 17. Power Window Circuit Breaker); Seatbelt Warning (also fuse 10, 21); Stoplights/Cruise Control (also fuse 6); Lights: Dash/Transmission Range (also fuse 23); Windshield Washer Jet Heaters.

FUSE NO.	SIZE/ COLOR	CIRCUIT PROTECTED
18	30A (LT GRN)	Auxiliary Fan.
19	25A (WT)	Sunroof.
20	25A (WT)	Rear Defogger.
21	7.5A (BR)	Active Check Cntrl (also fuses 6, 10, 12, 22, 23); Auto-Charging Flashlight; Gauges; Glove Box Light; Ignition Key Warning; Interior Lights (also fuse 17); On-Board Computer (also fuse 10, 12, 27); Radio (also fuses 12, 28. Radio In-Line Fuse); Seatbelt Warning (also fuses 10, 17); Service Interval Indicator (also fuse 10); Speedometer/Gauges/Warning Indicators (also fuse 10); Trunk Light.
22	7.5A (BR)	
23	7.5A (BR)	
24	15A (LT BU)	Lights: Turn/Hazard Warning (also fuse 4).
25		Not Used.
26	30A (LT GN)	
27	25A (WT)	Central Locking; Heated Door Lock.
28	25A (WT)	Cigar Lighter; Power Antenna (also fuse 17. Power Window Circuit Breaker).
29	7.5A (BR)	Fog Lights (also fuse 30).
30	7.5A (BR)	Fog Lights (also fuse 29).
Power Window Circuit Breaker	25	Power Windows.

# 104 POWER DISTRIBUTION

(For Component Locations See Page 210)

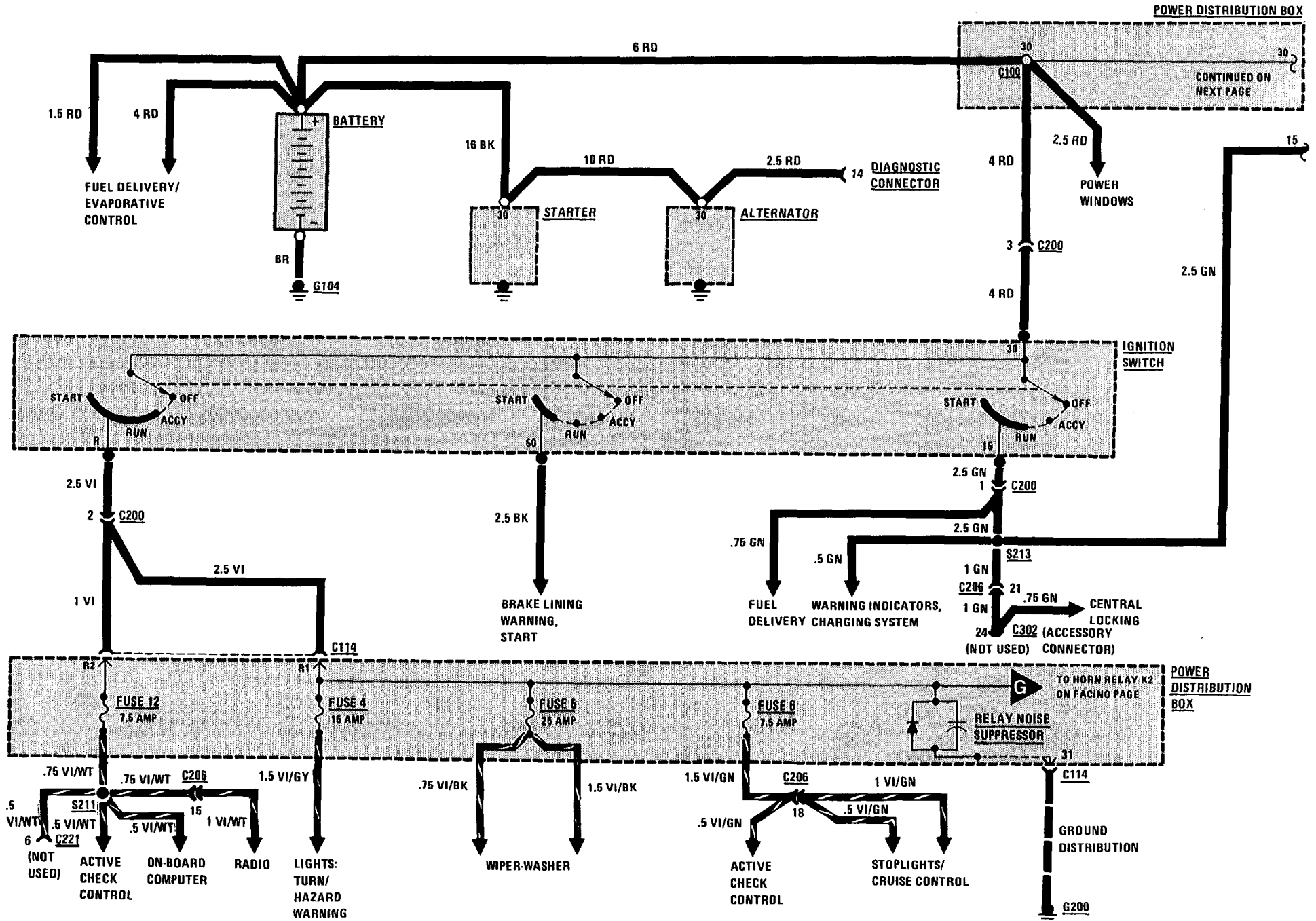

(For Component Locations See Page 210)

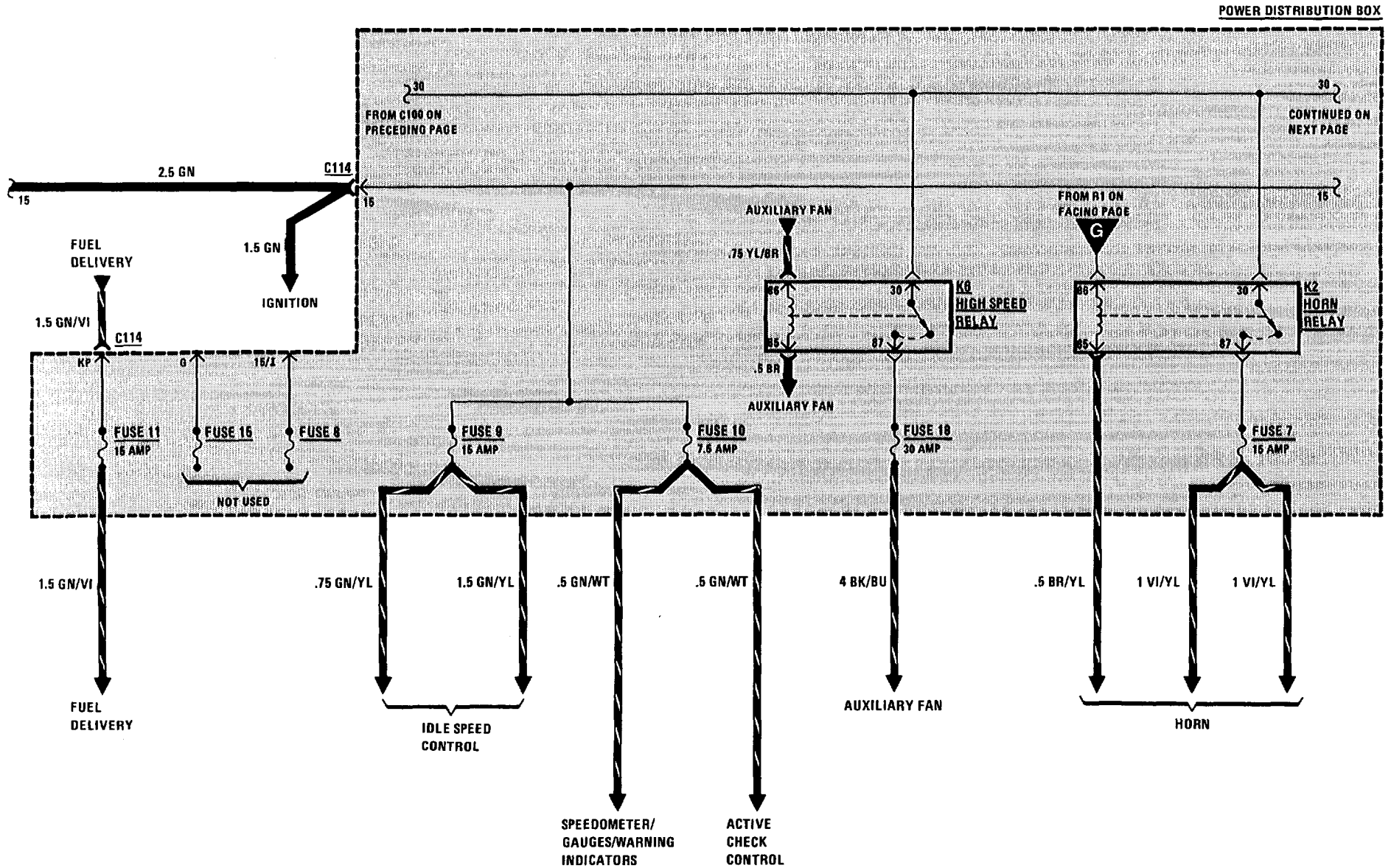

# 106 POWER DISTRIBUTION

(For Component Locations See Page 210)

POWER DISTRIBUTION BOX

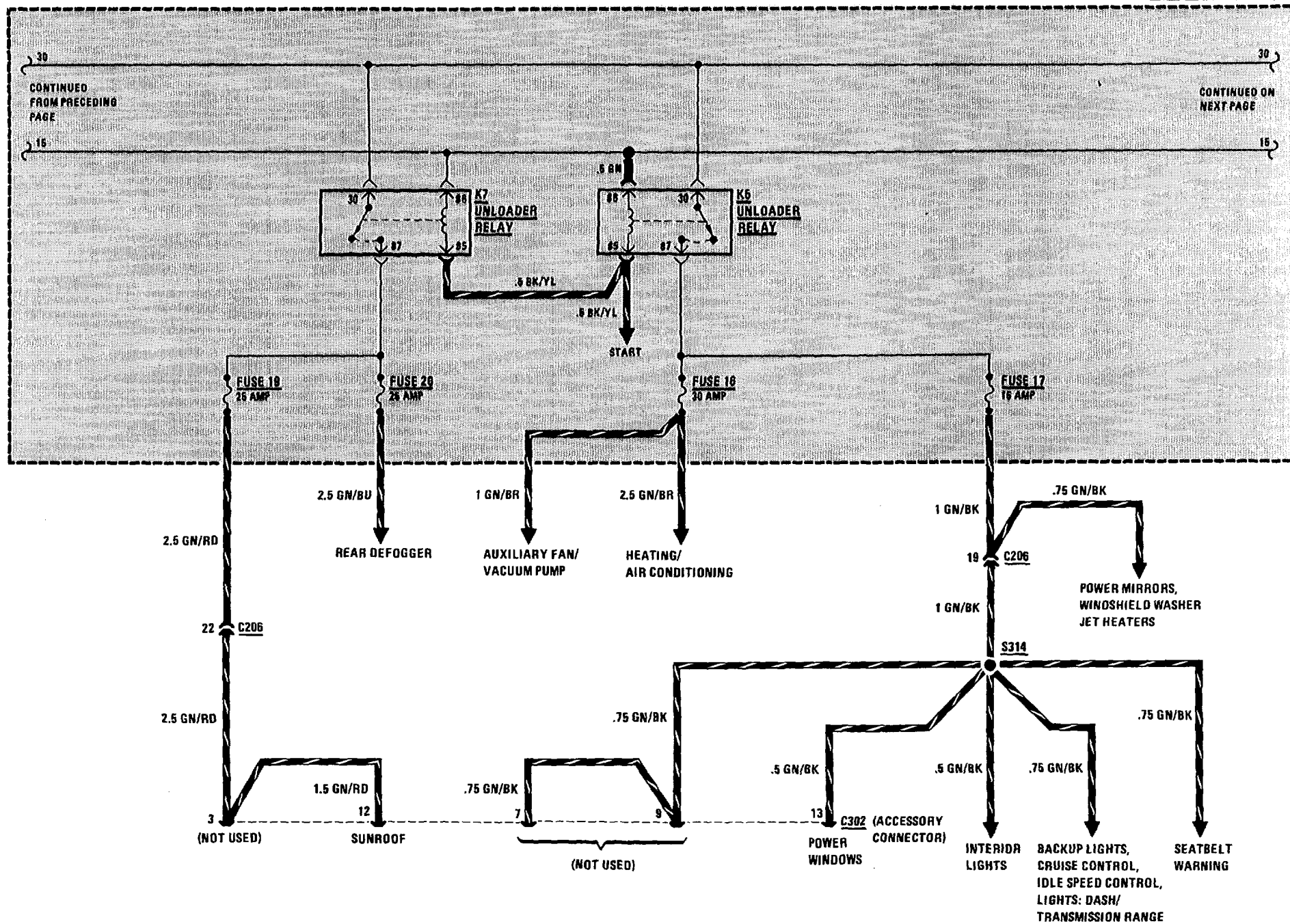



(For Component Locations See Page 210)

POWER DISTRIBUTION BOX

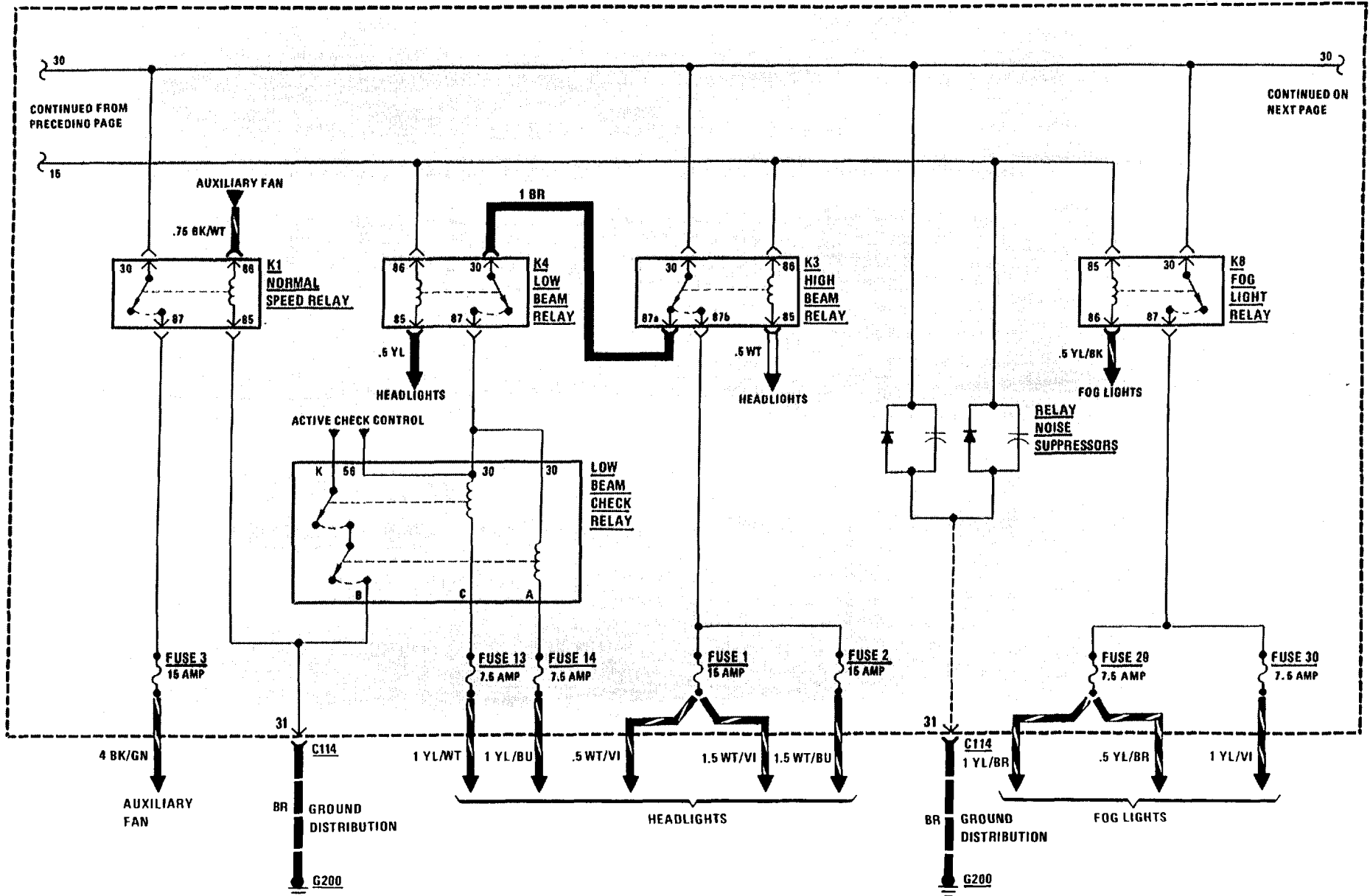

CONTINUED FROM PRECEDING PAGE

CONTINUED ON NEXT PAGE

# 108 POWER DISTRIBUTION

(For Component Locations See Page 210)

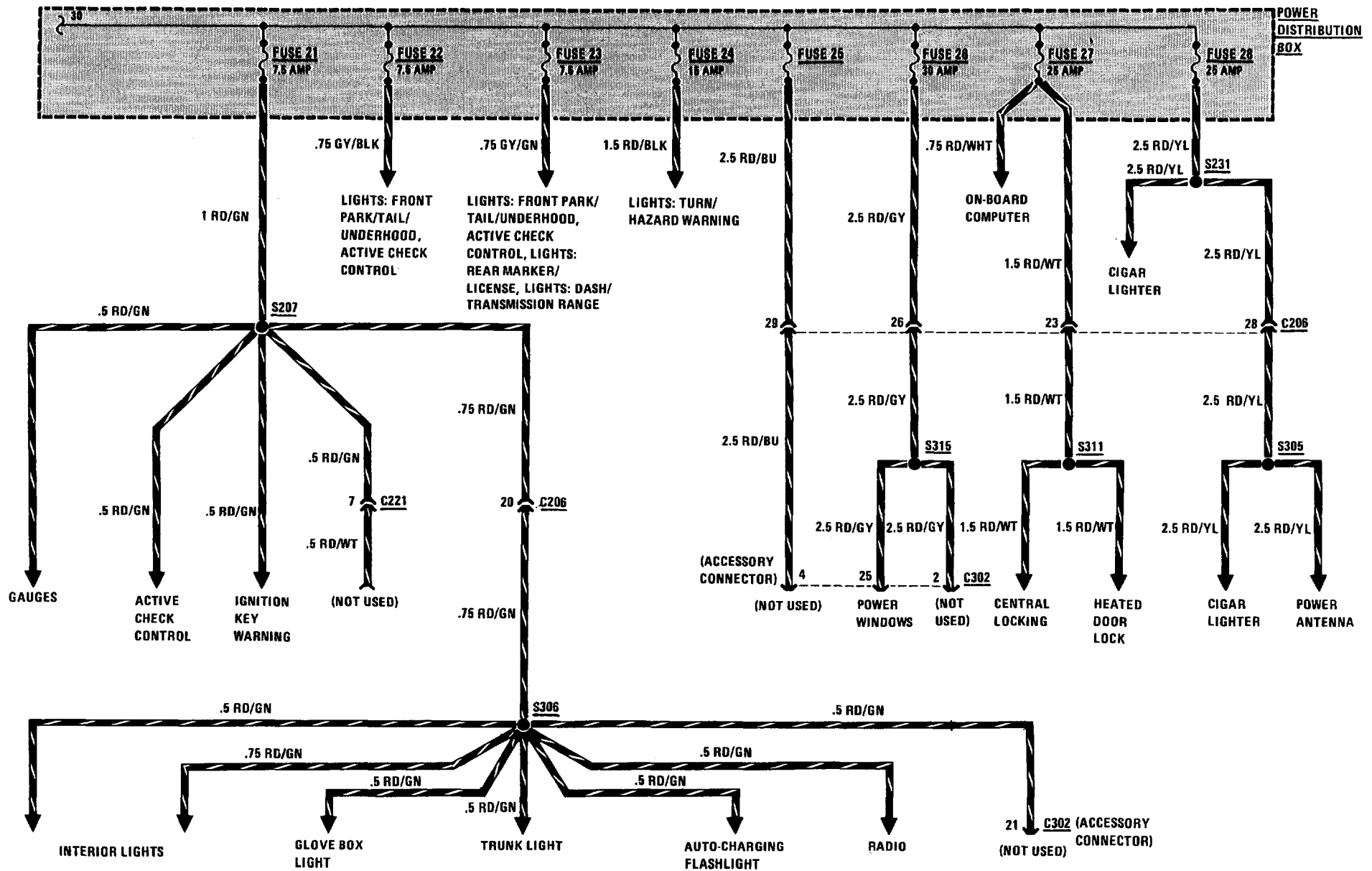

(For Component Locations See Page 204)

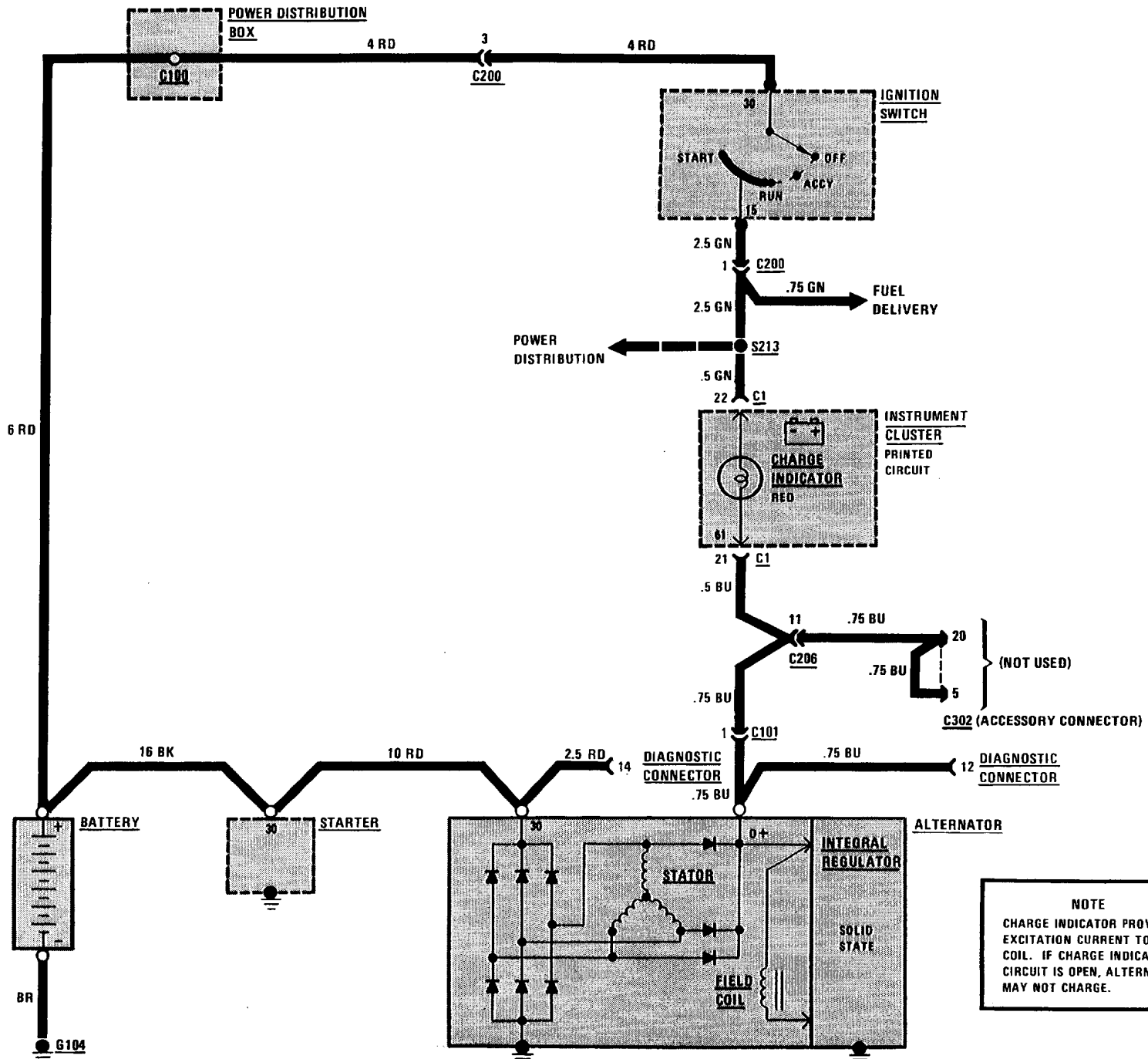

**NOTE**  
 CHARGE INDICATOR PROVIDES EXCITATION CURRENT TO FIELD COIL. IF CHARGE INDICATOR CIRCUIT IS OPEN, ALTERNATOR MAY NOT CHARGE.

# 110 START

(For Component Locations See Page 212)

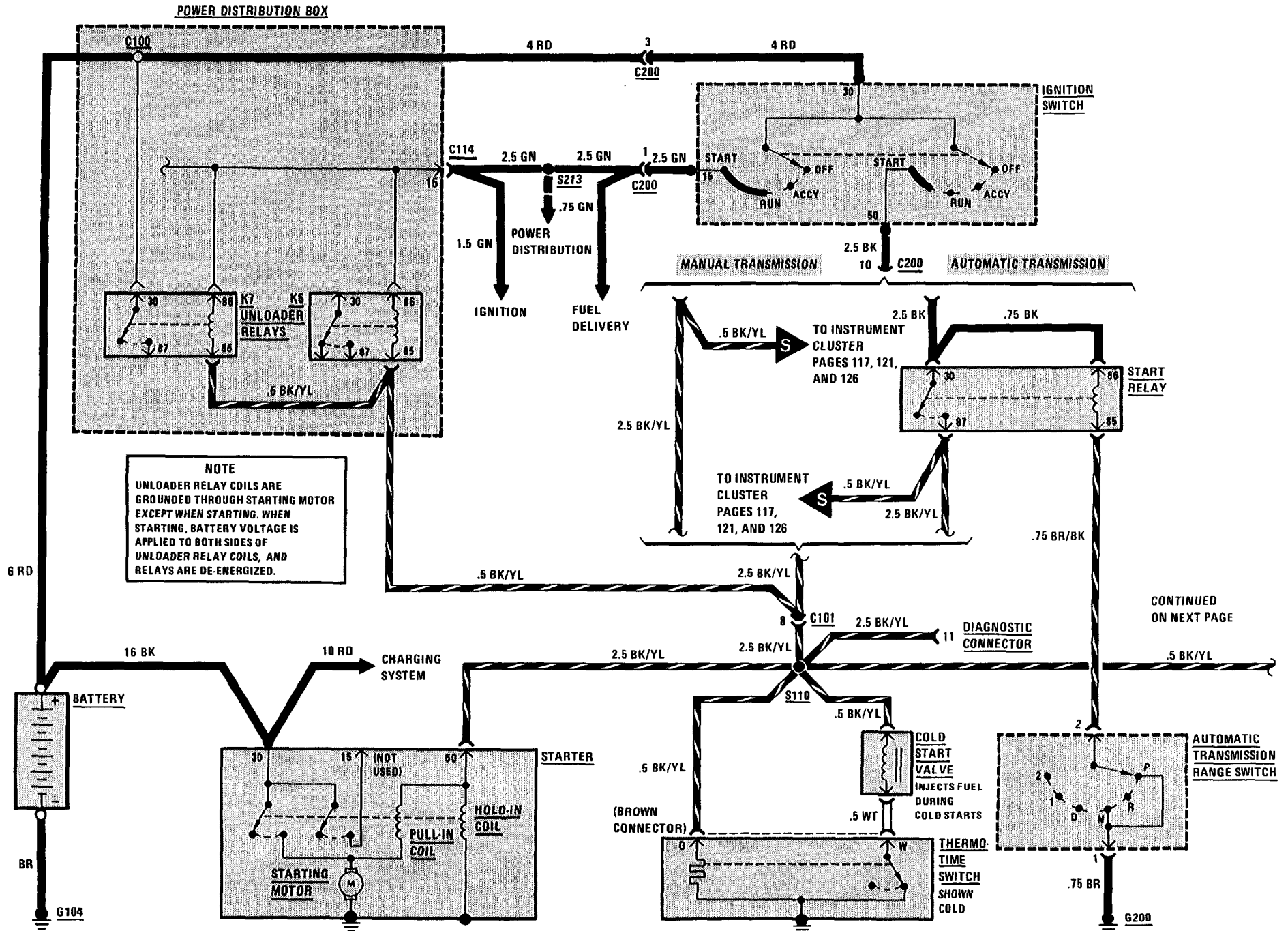

(For Component Locations See Page 205)

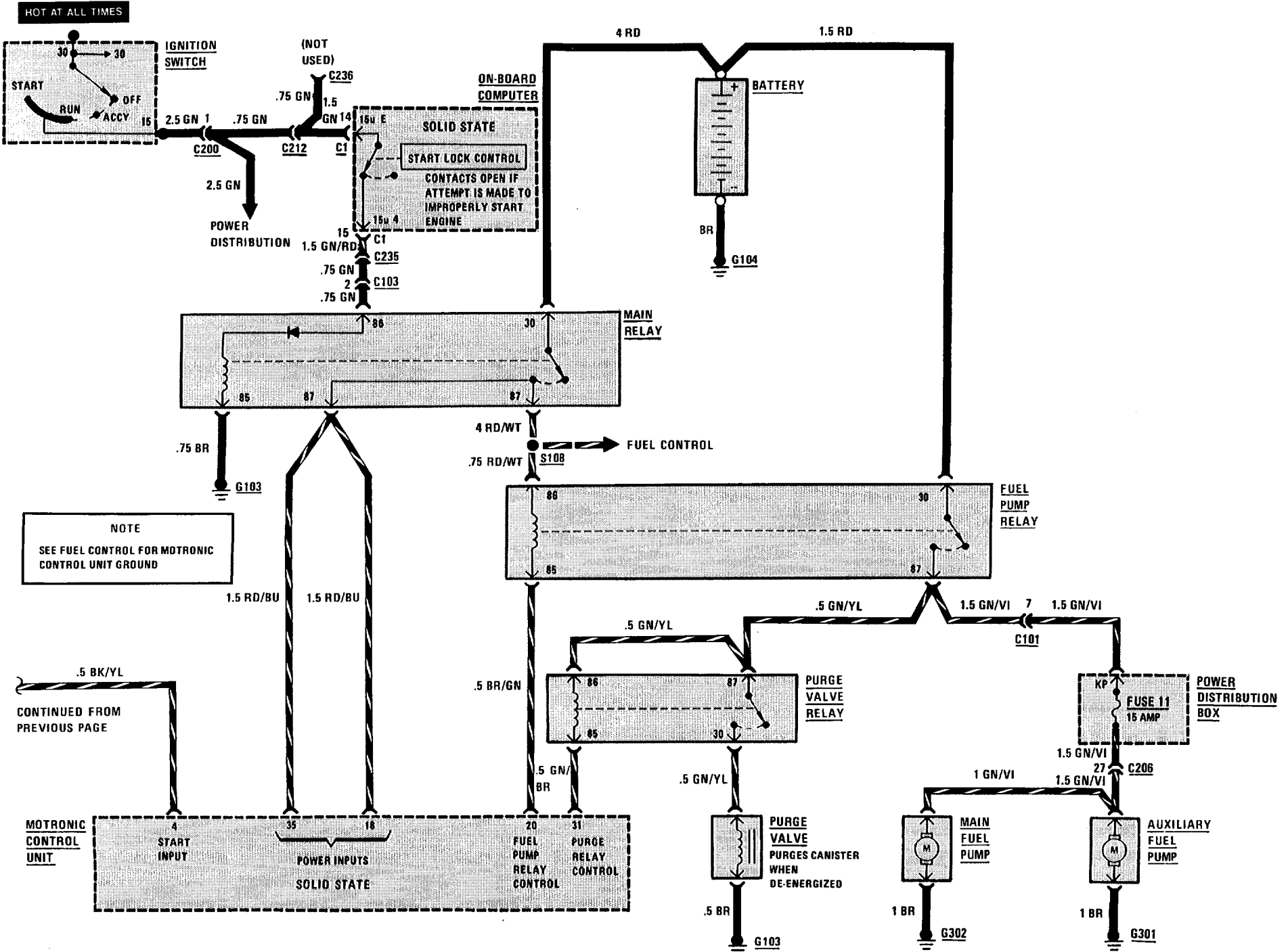

# 112 IDLE SPEED CONTROL

(For Component Locations See Page 206)

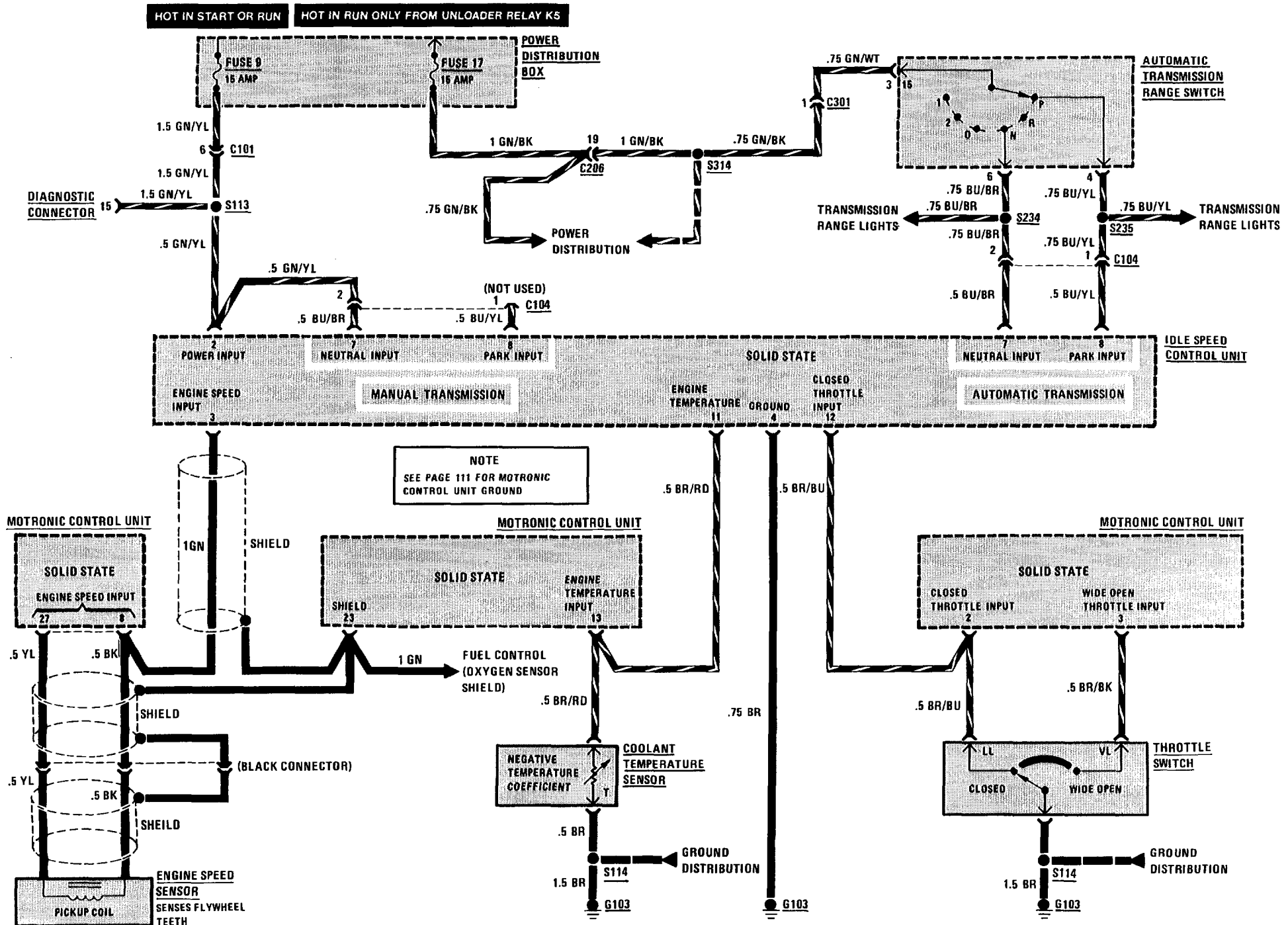

(For Component Locations See Page 206)

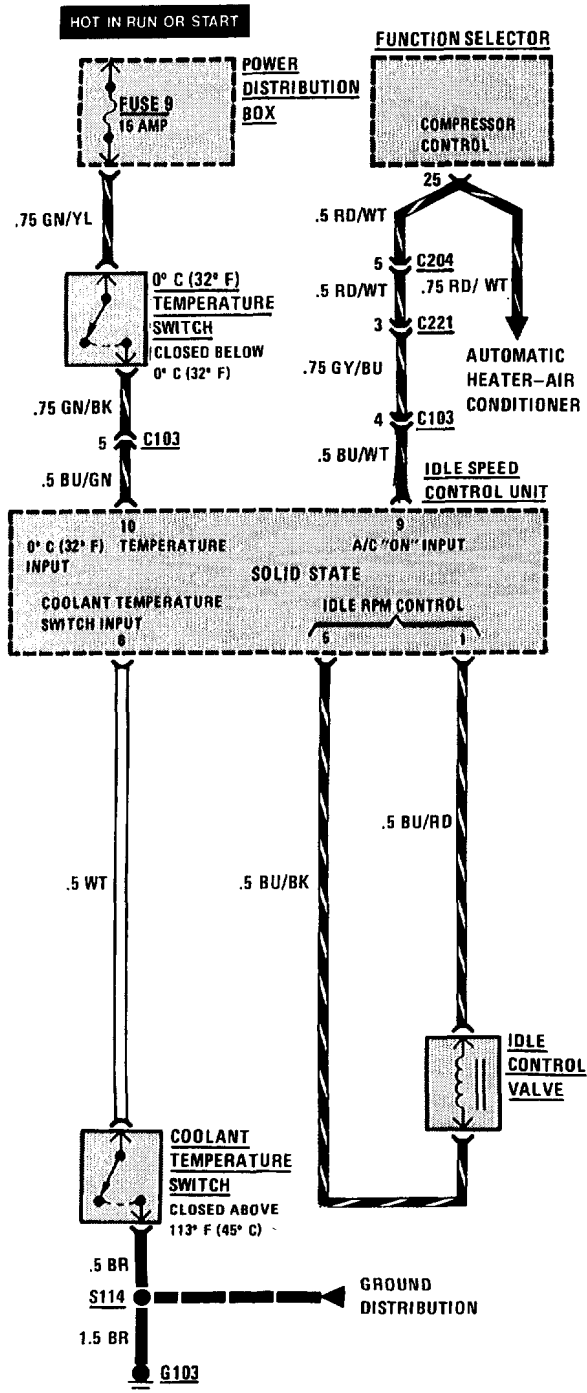

(For Component Locations See Page 207)

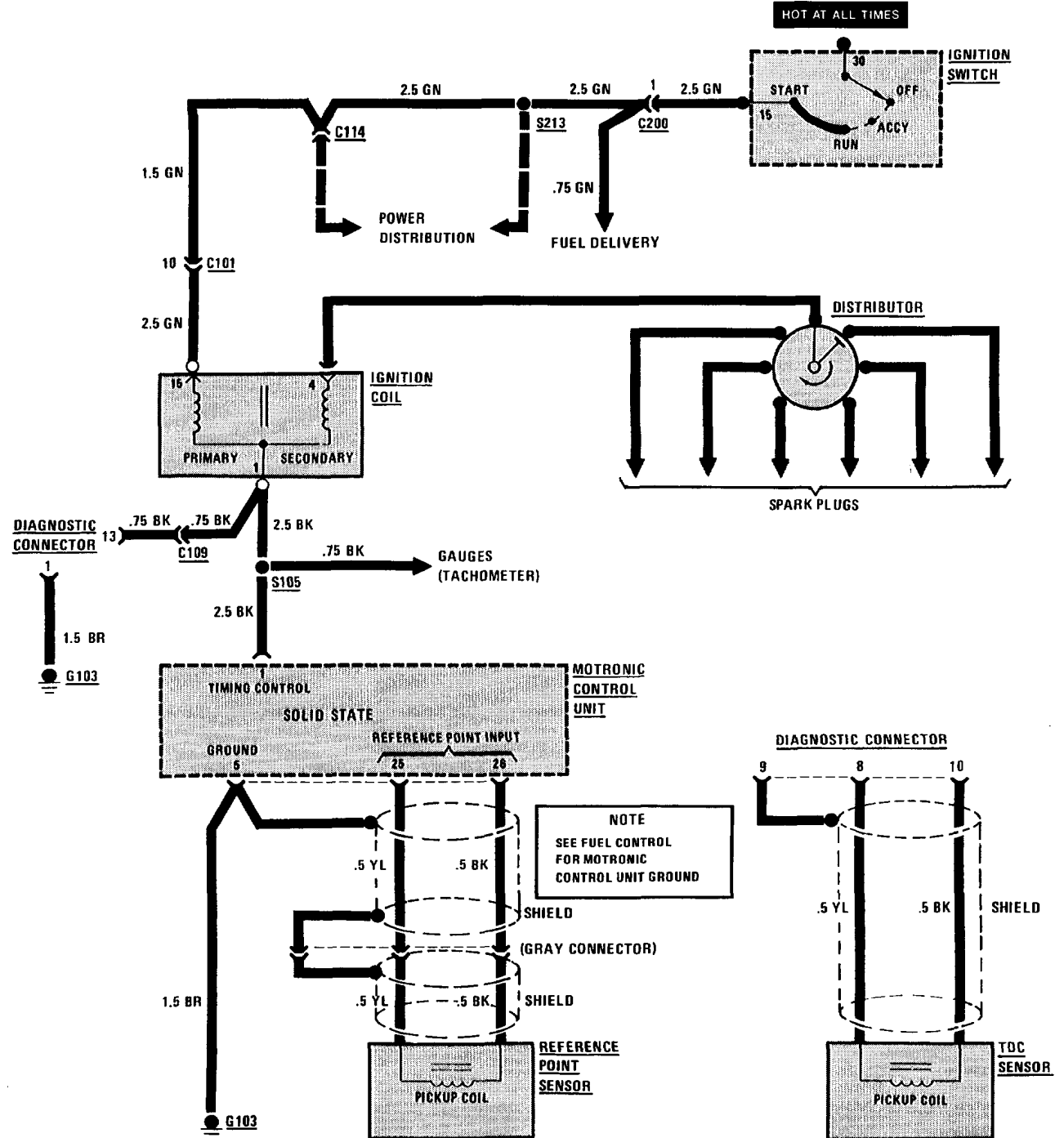

# 114 FUEL CONTROL

(For Component Locations See Page 204)

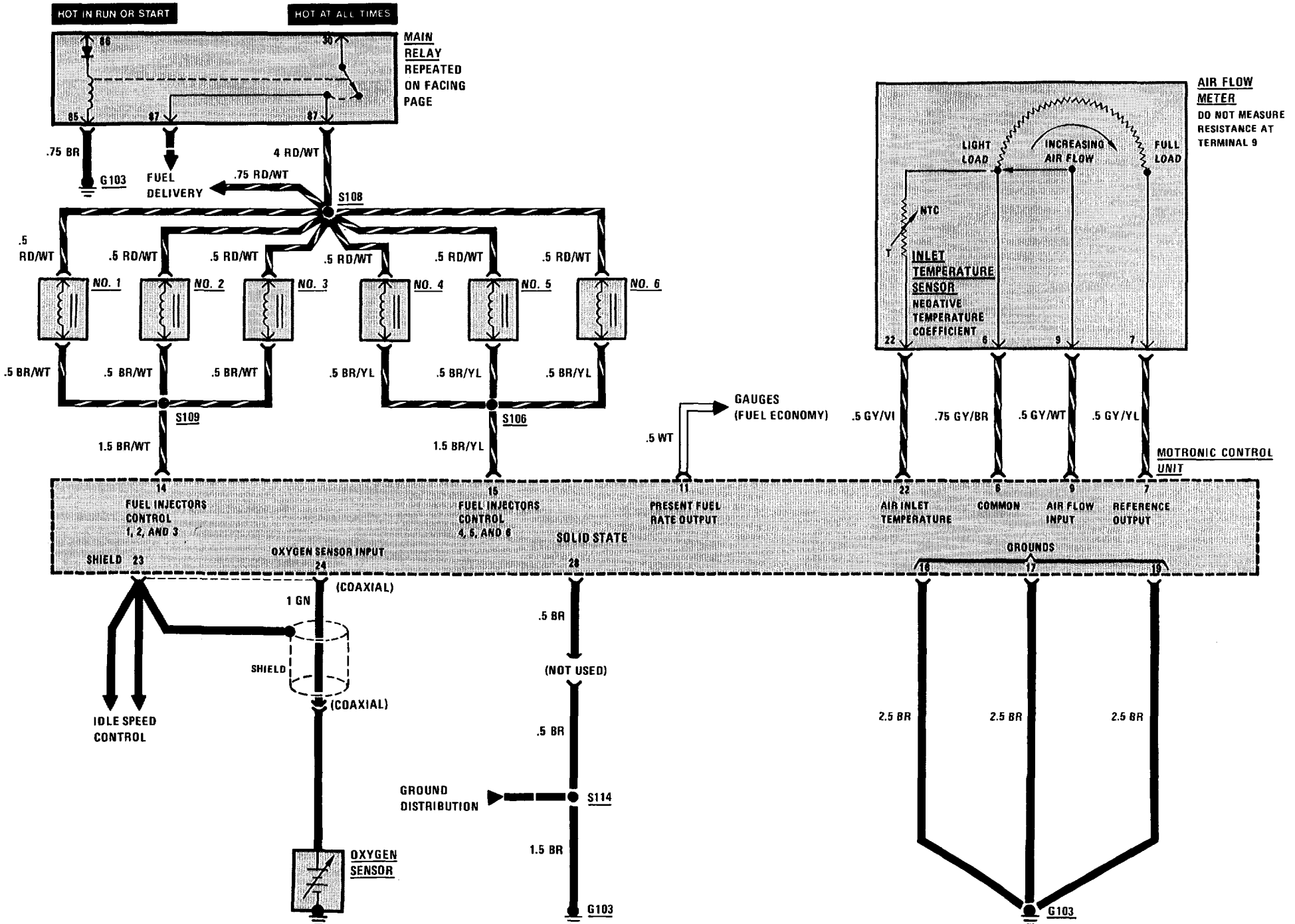



(For Component Locations See Page 207)

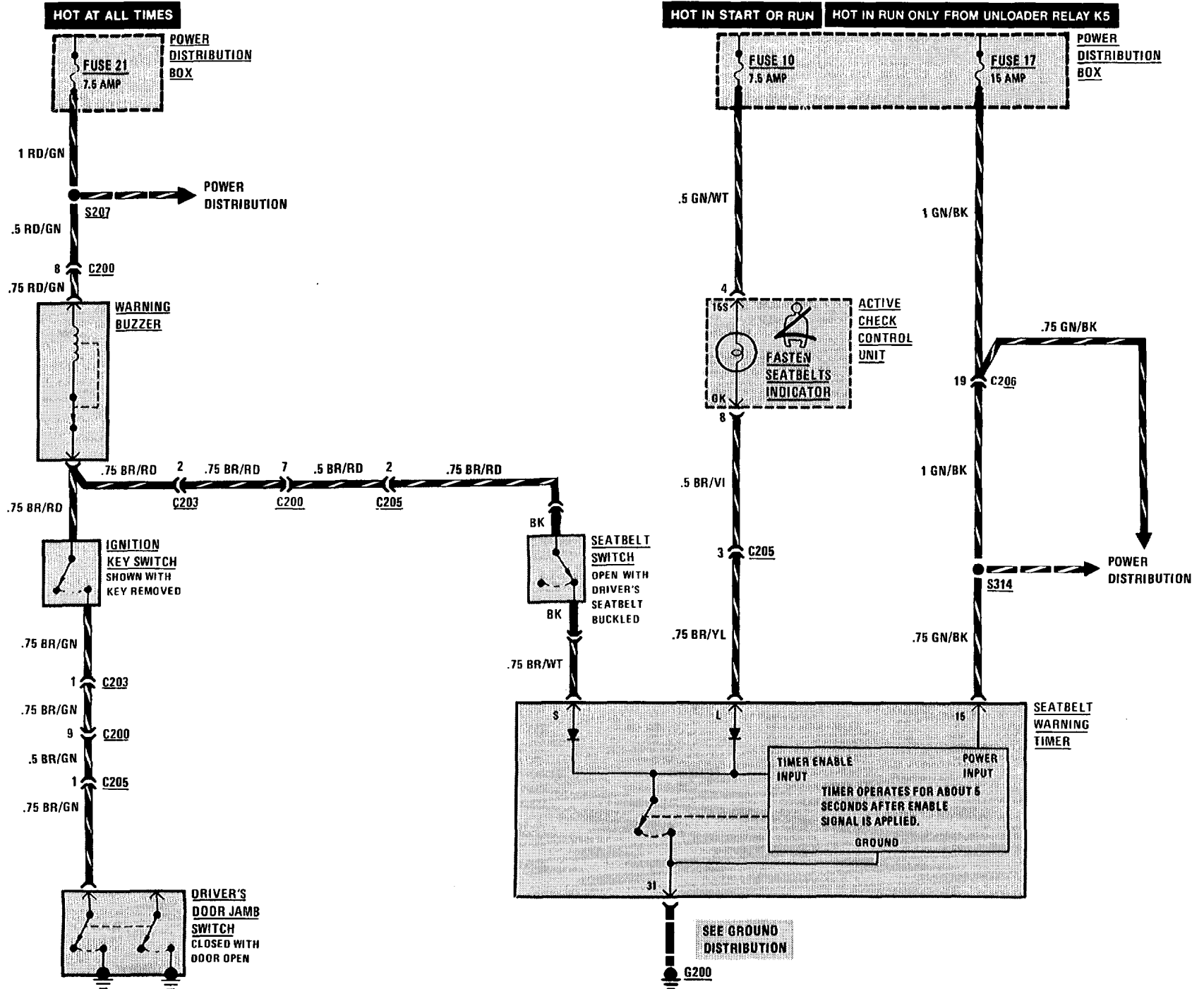

# 116 ON-BOARD COMPUTER

(For Component Locations See Page 209)

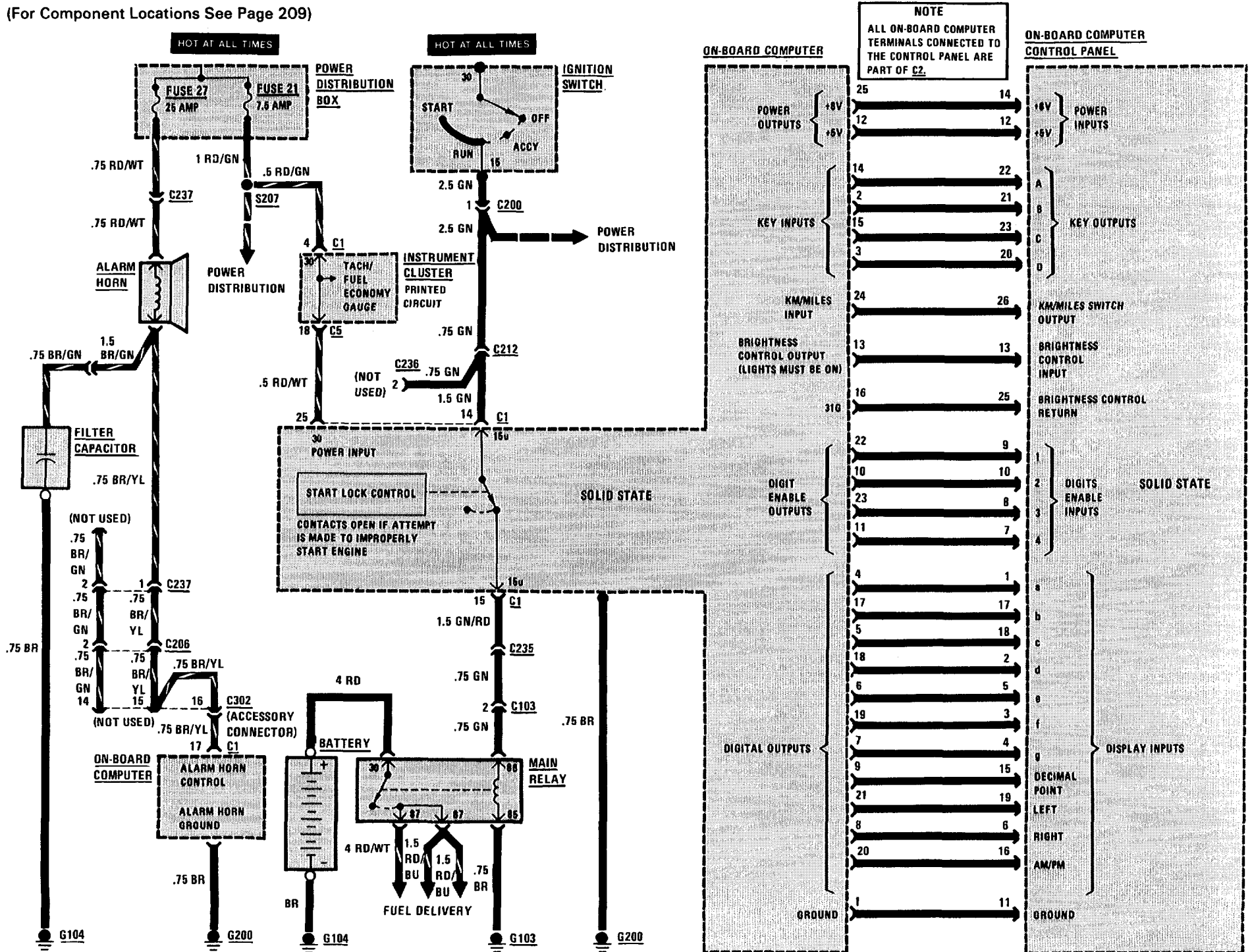

(For Component Locations See Page 209)

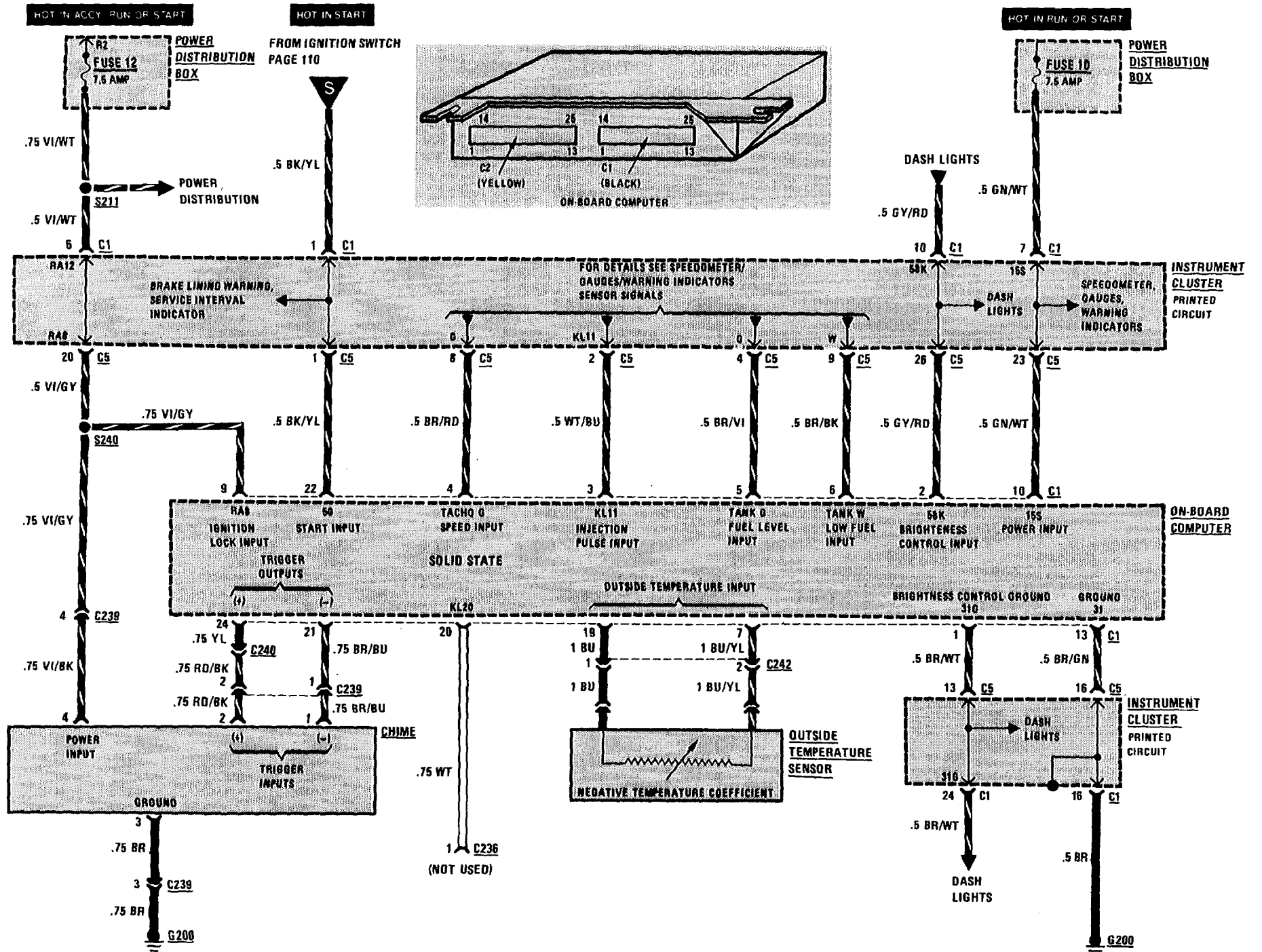



(For Component Locations See Page 212)

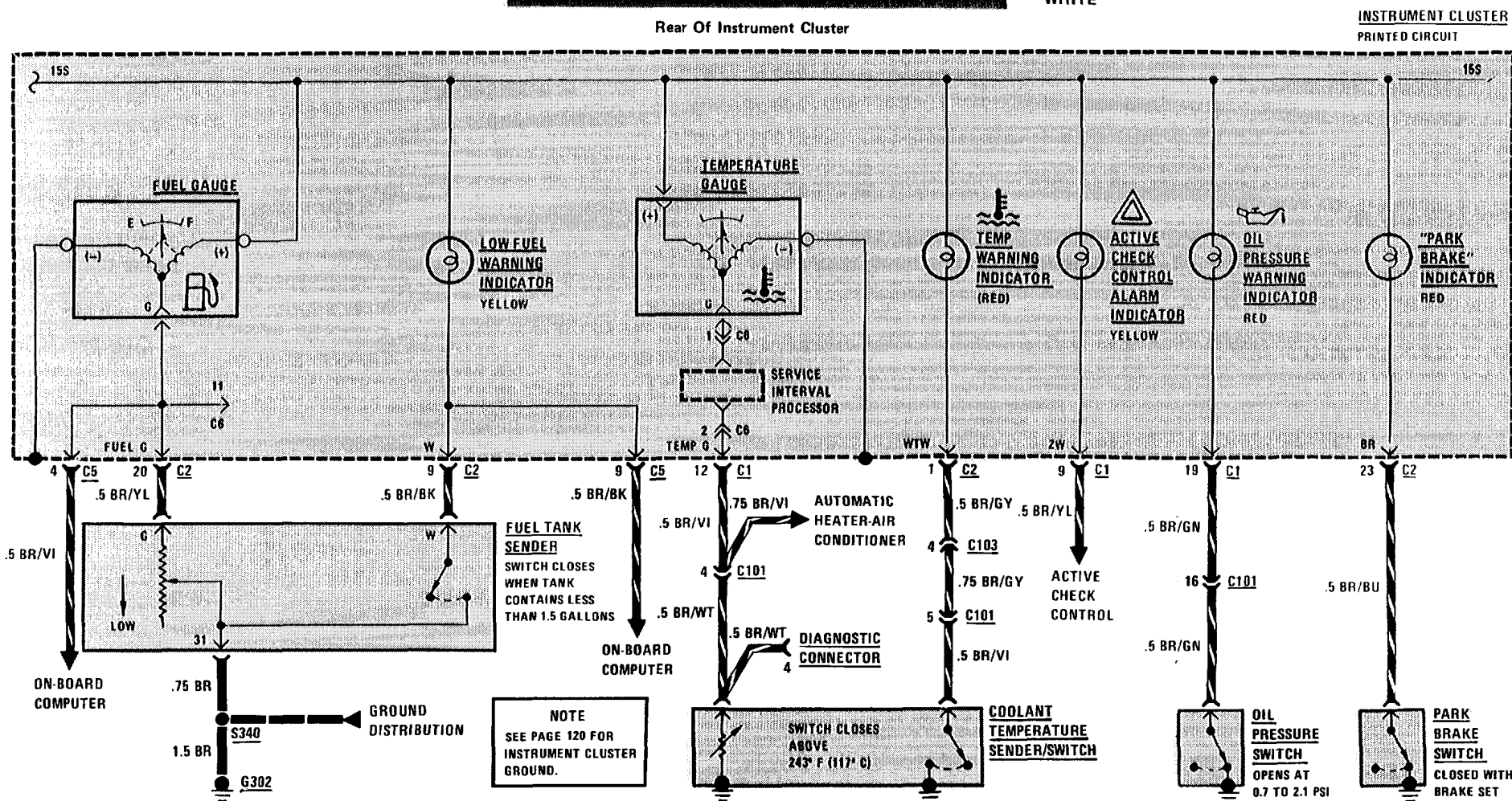
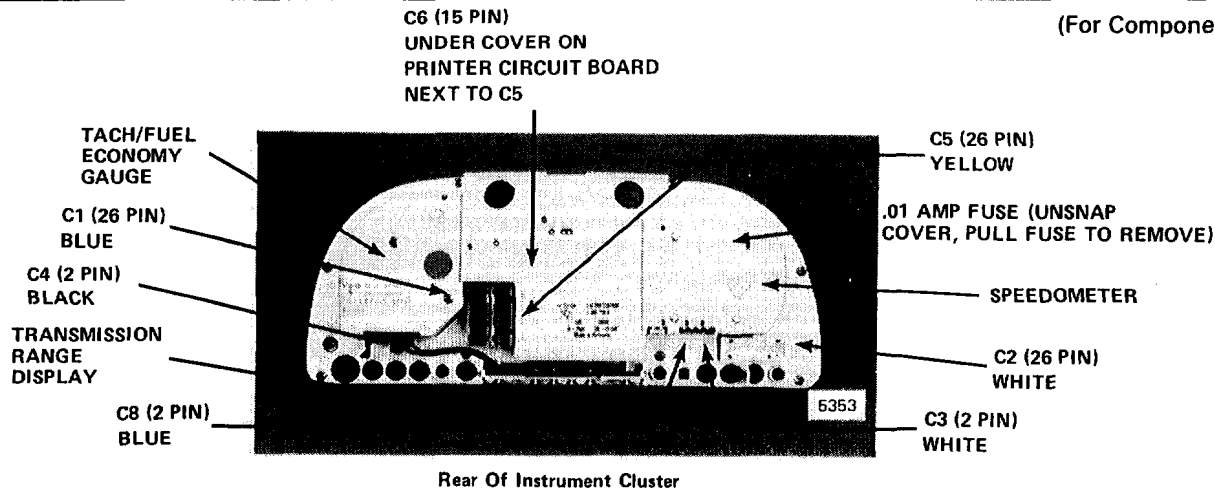

# 120 WARNING INDICATORS

(For Component Locations See Page 212)

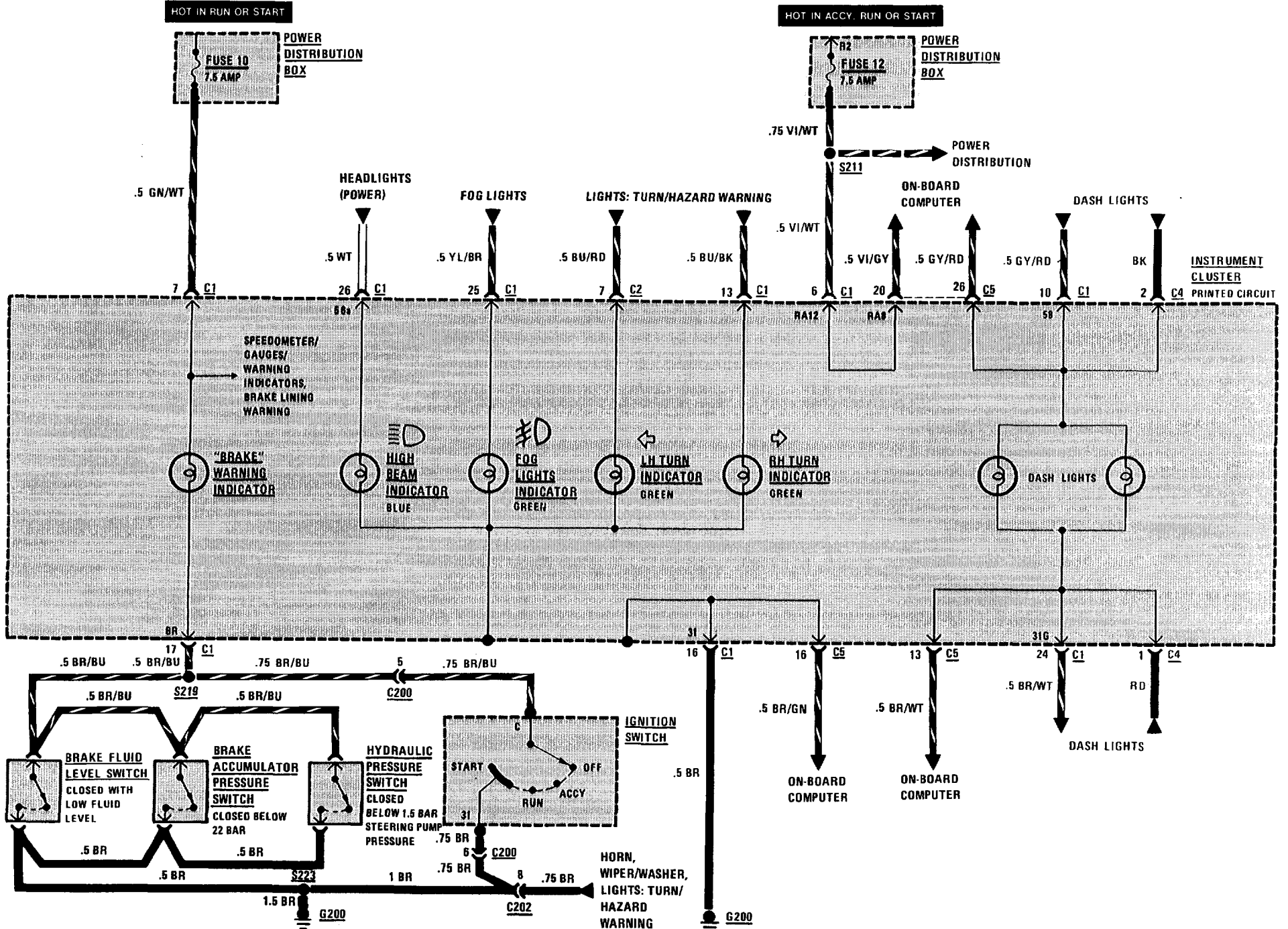

(For Component Locations See Page 211)

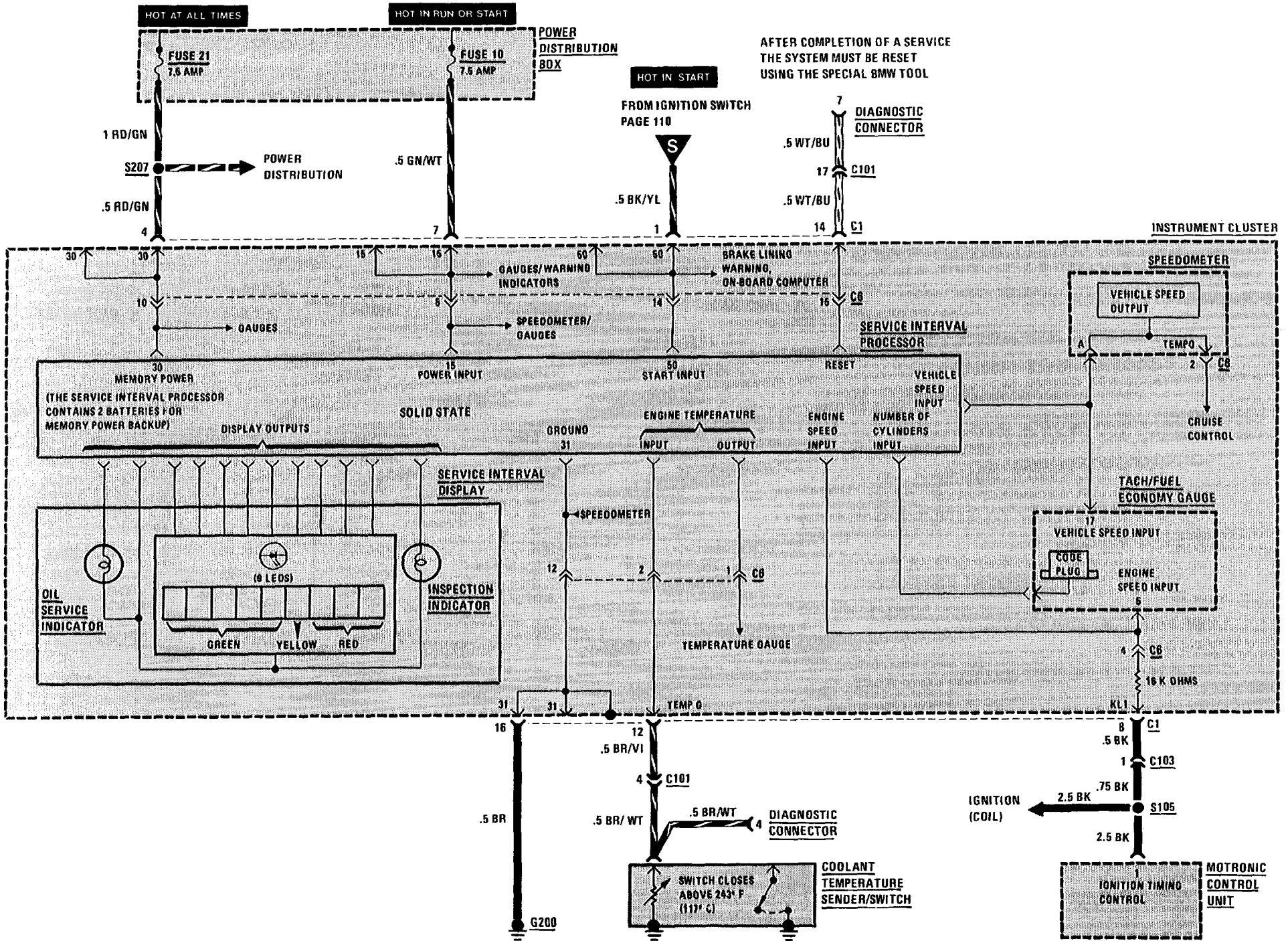

# 122 WIPER/WASHER

(For Component Locations See Page 215)

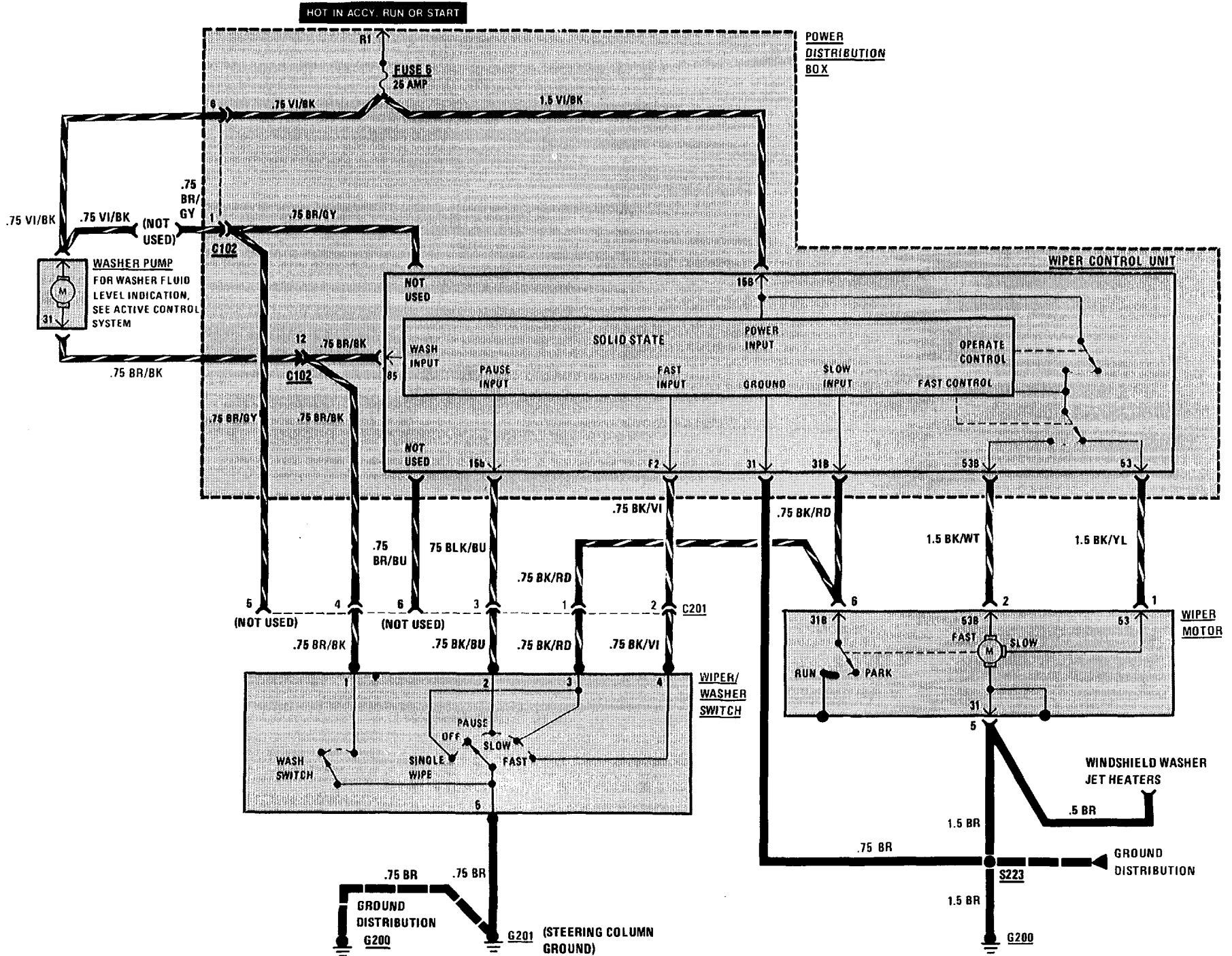



(For Component Locations See Page 201)

## ACTIVE CHECK CONTROL

1. When the Ignition Switch is initially placed in "Run," the Active Check Control Arm Indicator flashes, and the Active Check Control Unit Brake Light LED and panel light illuminate for test purposes. Depressing the brake pedal clears the display.
2. When the Ignition Switch is placed in "Run," fault monitoring begins. To monitor the low beams, rear lights, or license lights, those circuits must be on. The brake lights are monitored only while the brake pedal is depressed.
3. When a fault occurs, the alarm indicator flashes, the appropriate LED fault indicator lights, and the panel light goes on for five seconds. Depressing the test button will clear the alarm indicator, but the LED fault indicator remains on.

4. To test the unit, depress the test button. The LED fault indicators and the panel lights should go on.

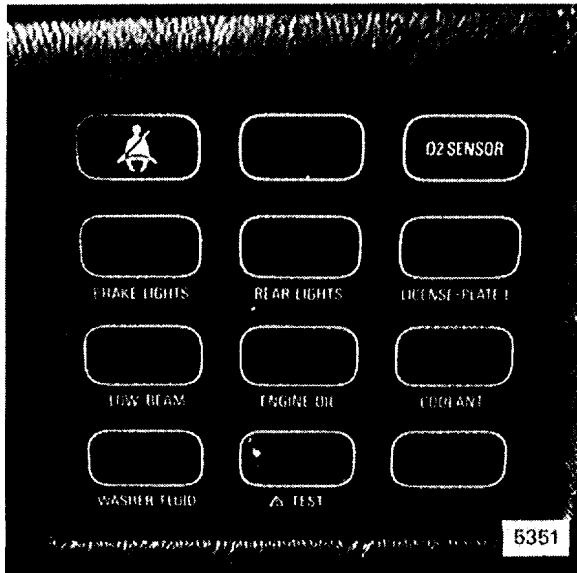
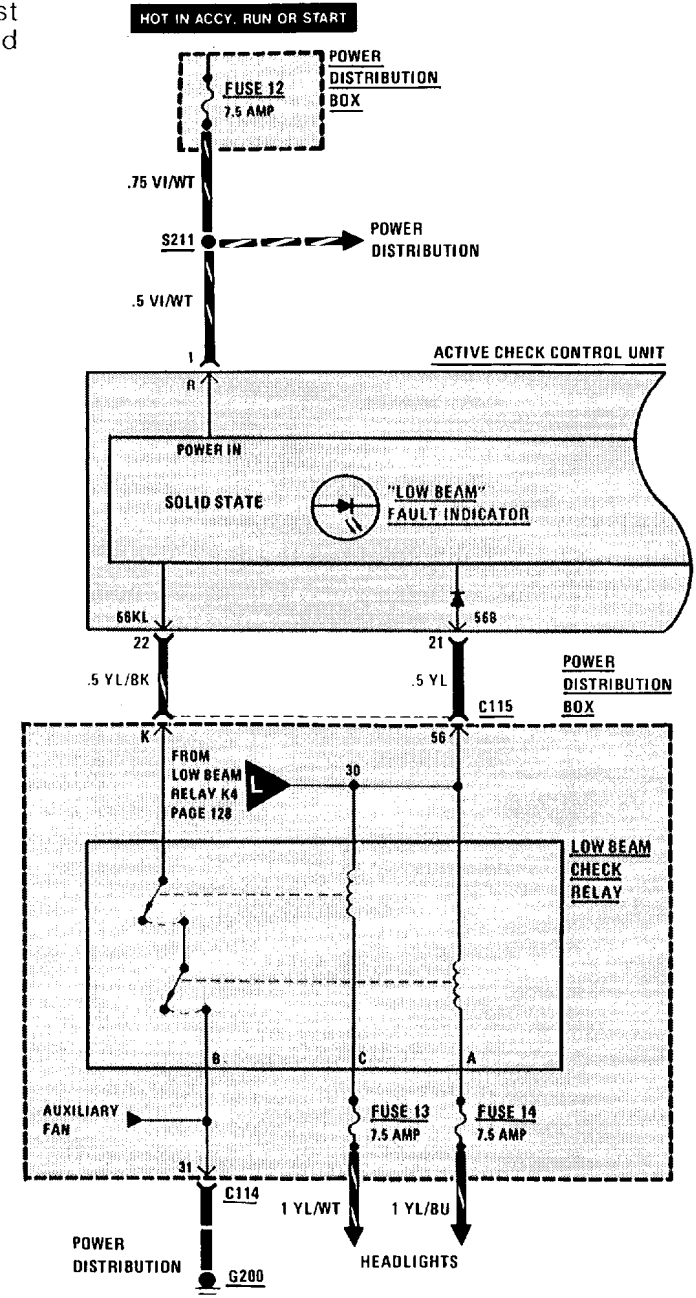
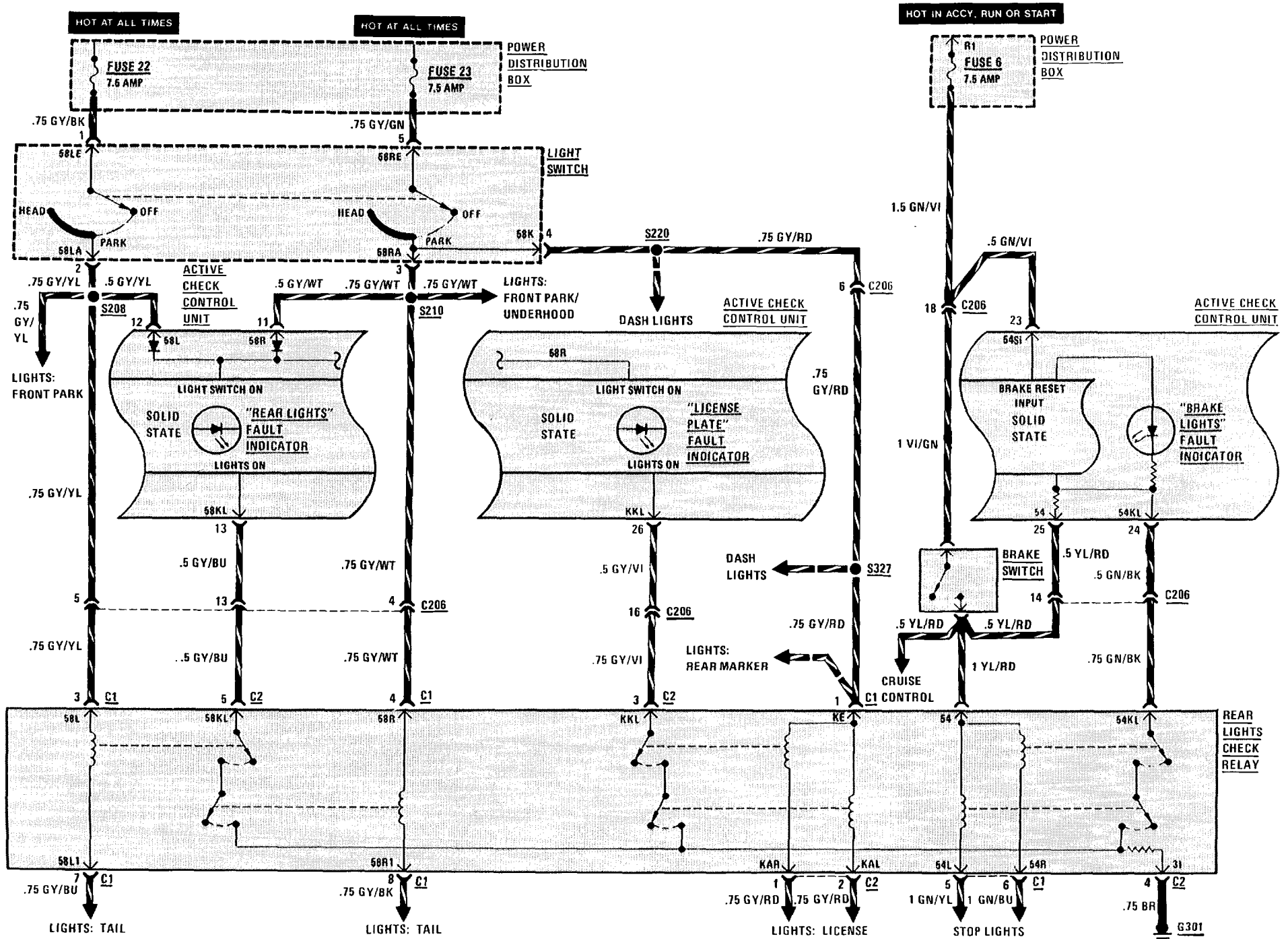

Figure 1 - Active Check Control Unit (Dash, Left Of Steering Column)



# 124 ACTIVE CHECK CONTROL

(For Component Locations See Page 201)



# ACTIVE CHECK CONTROL 125

(For Component Locations See Page 201)

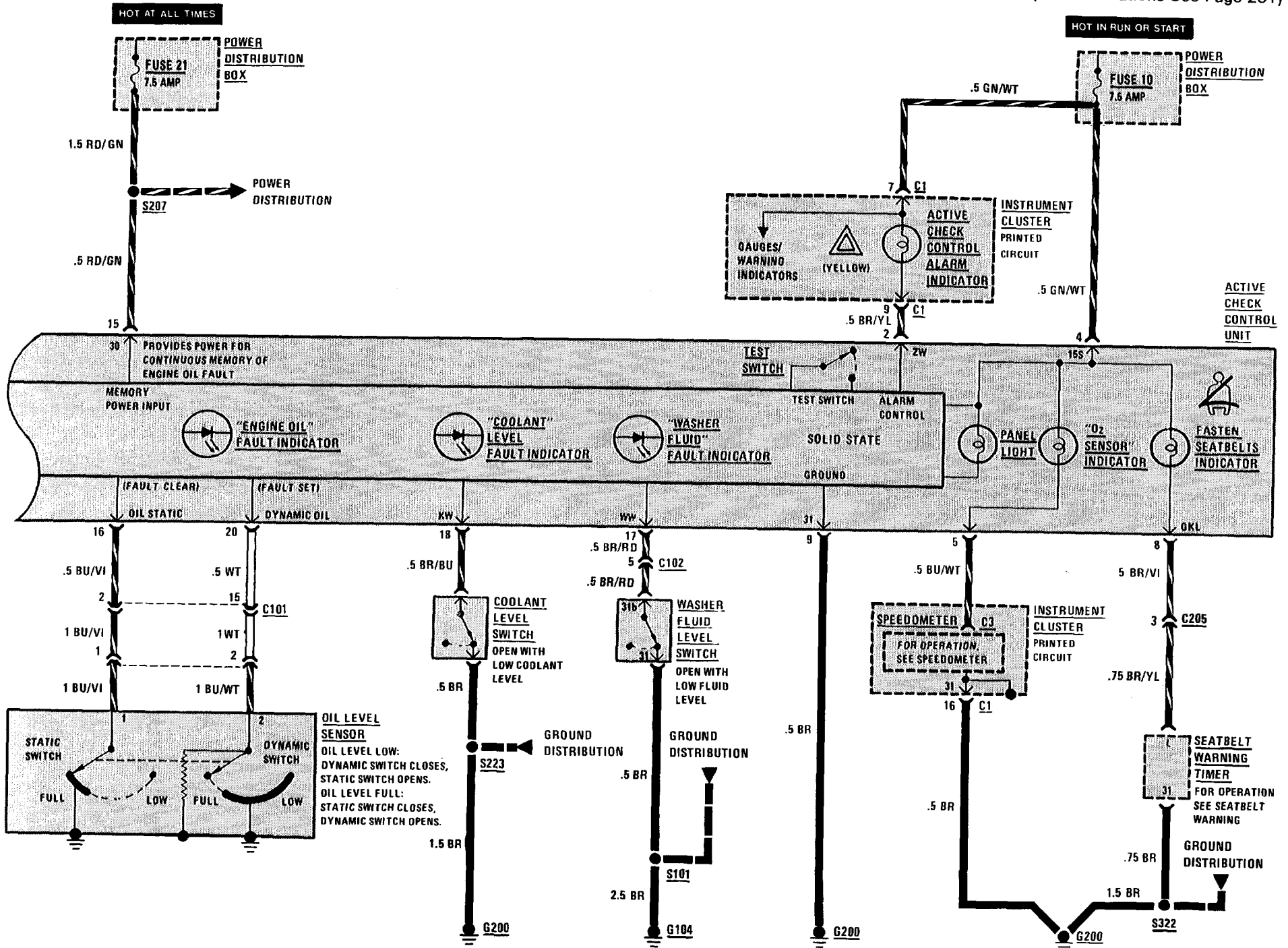

# 126 BRAKE LINING WARNING

(For Component Locations See Page 203)

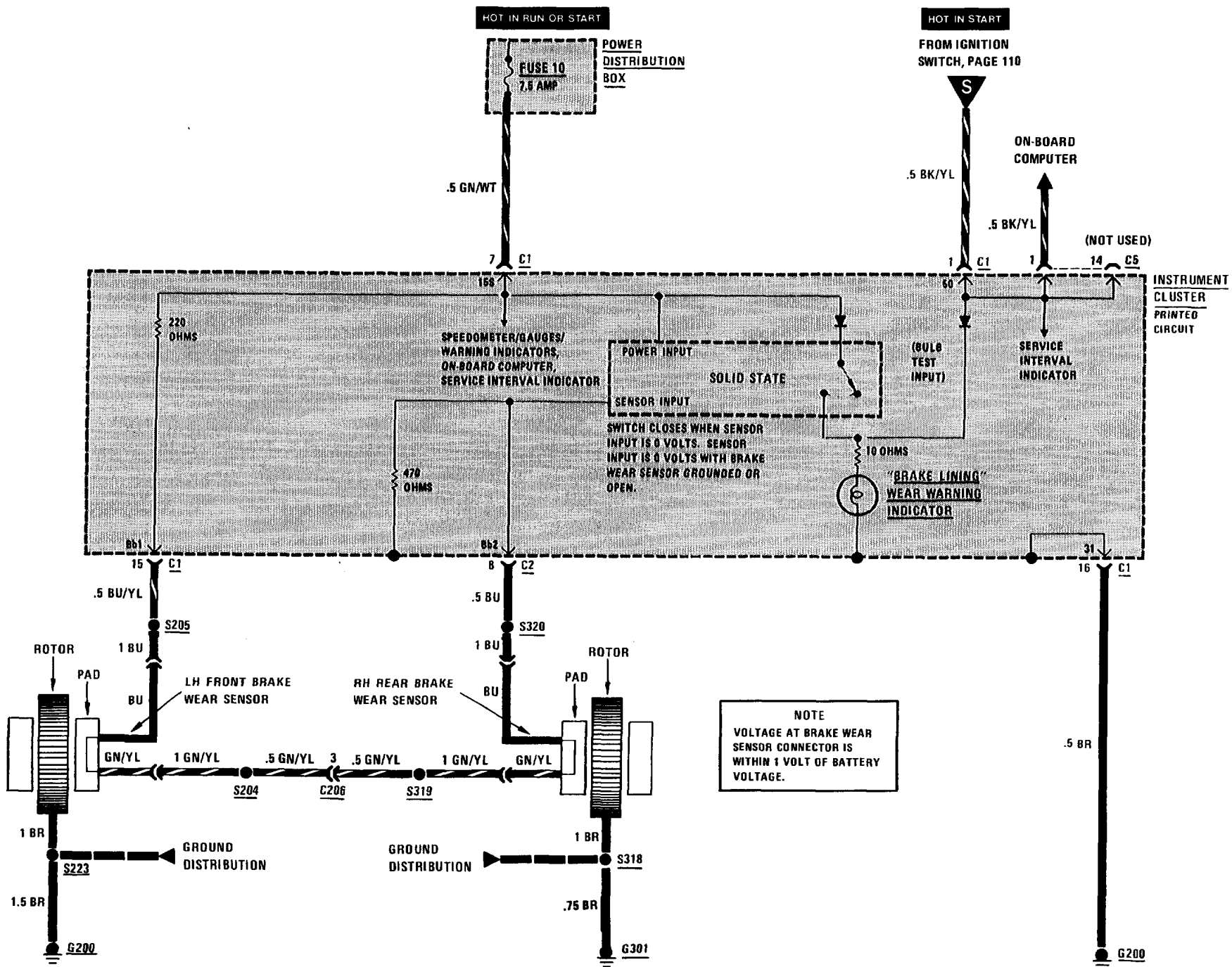

(For Component Locations See Page 207)

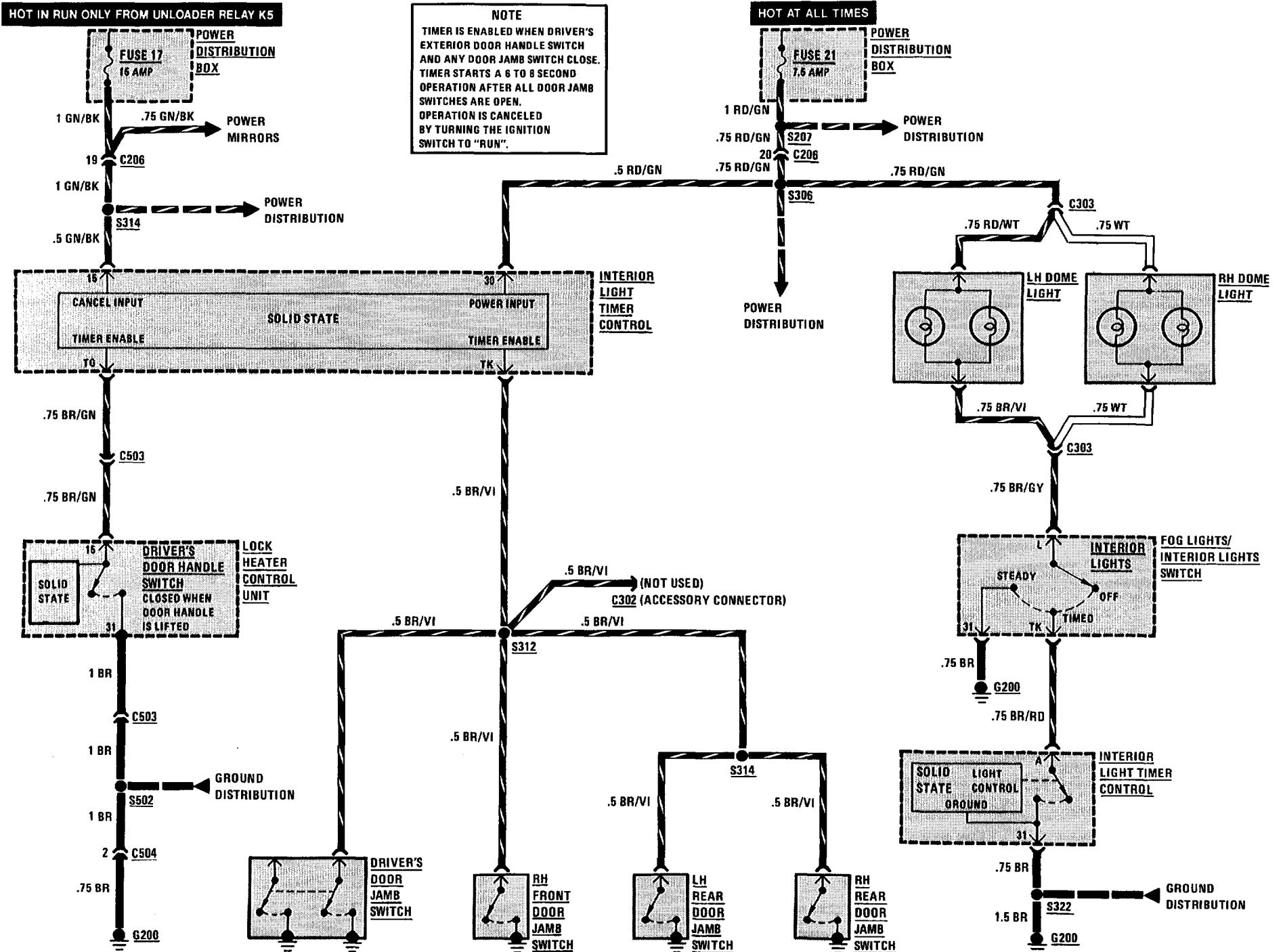

# 128 HEADLIGHTS (CONTROL)/FOG LIGHTS

(For Component Locations See Page 205)

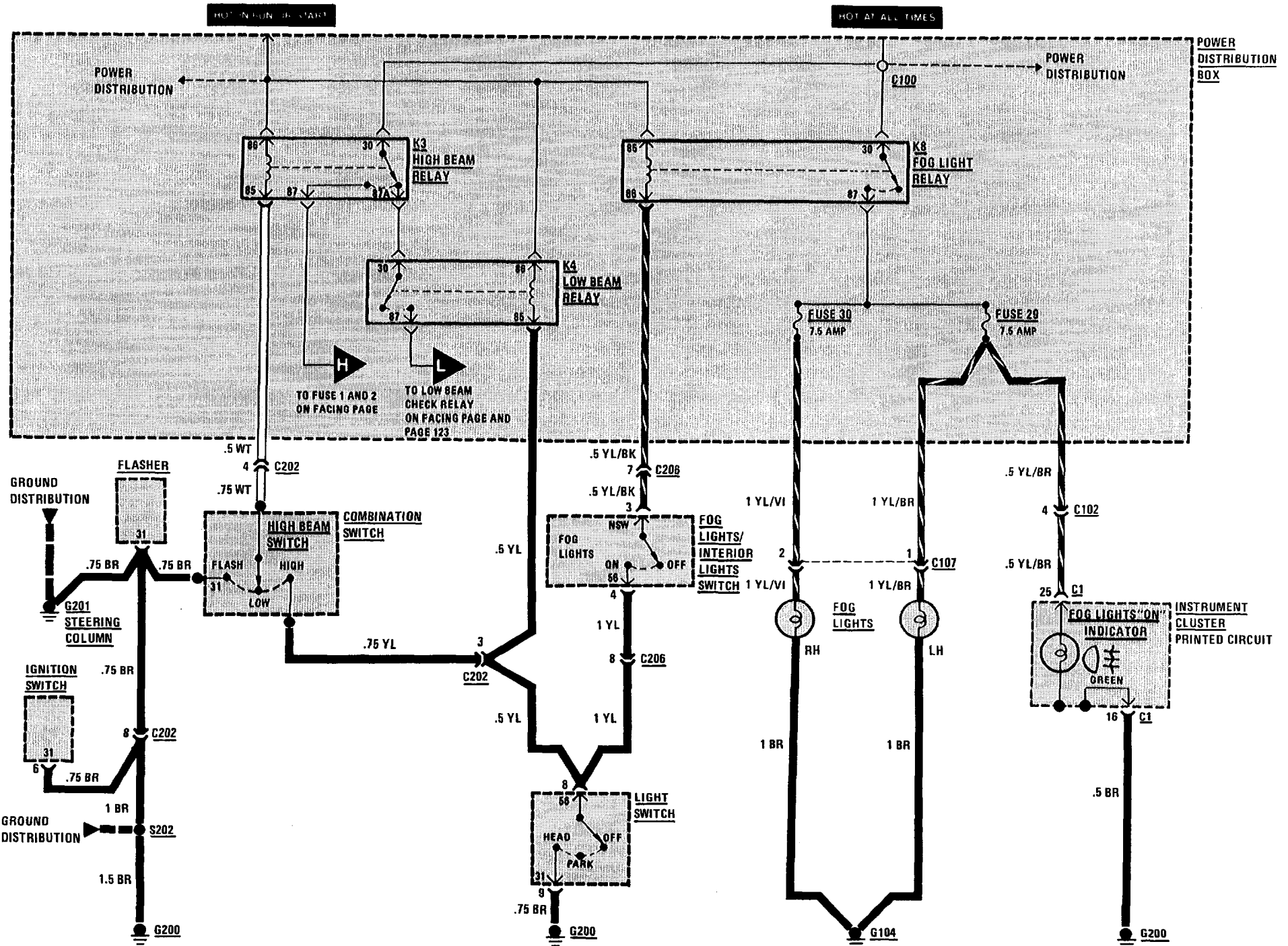

(For Component Locations See Page 205)

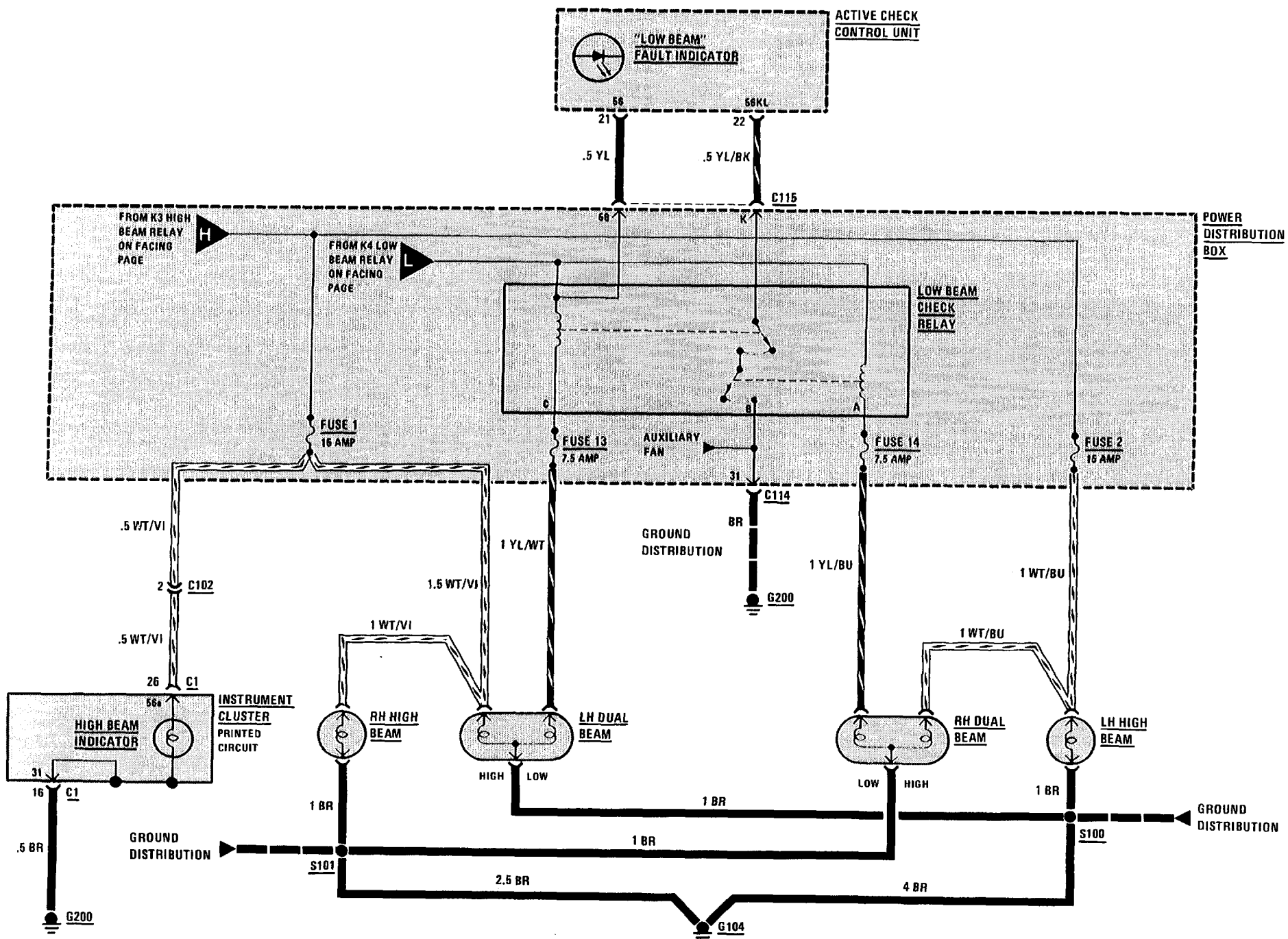

# 130 LIGHTS: TURN/HAZARD WARNING

(For Component Locations See Page 209)

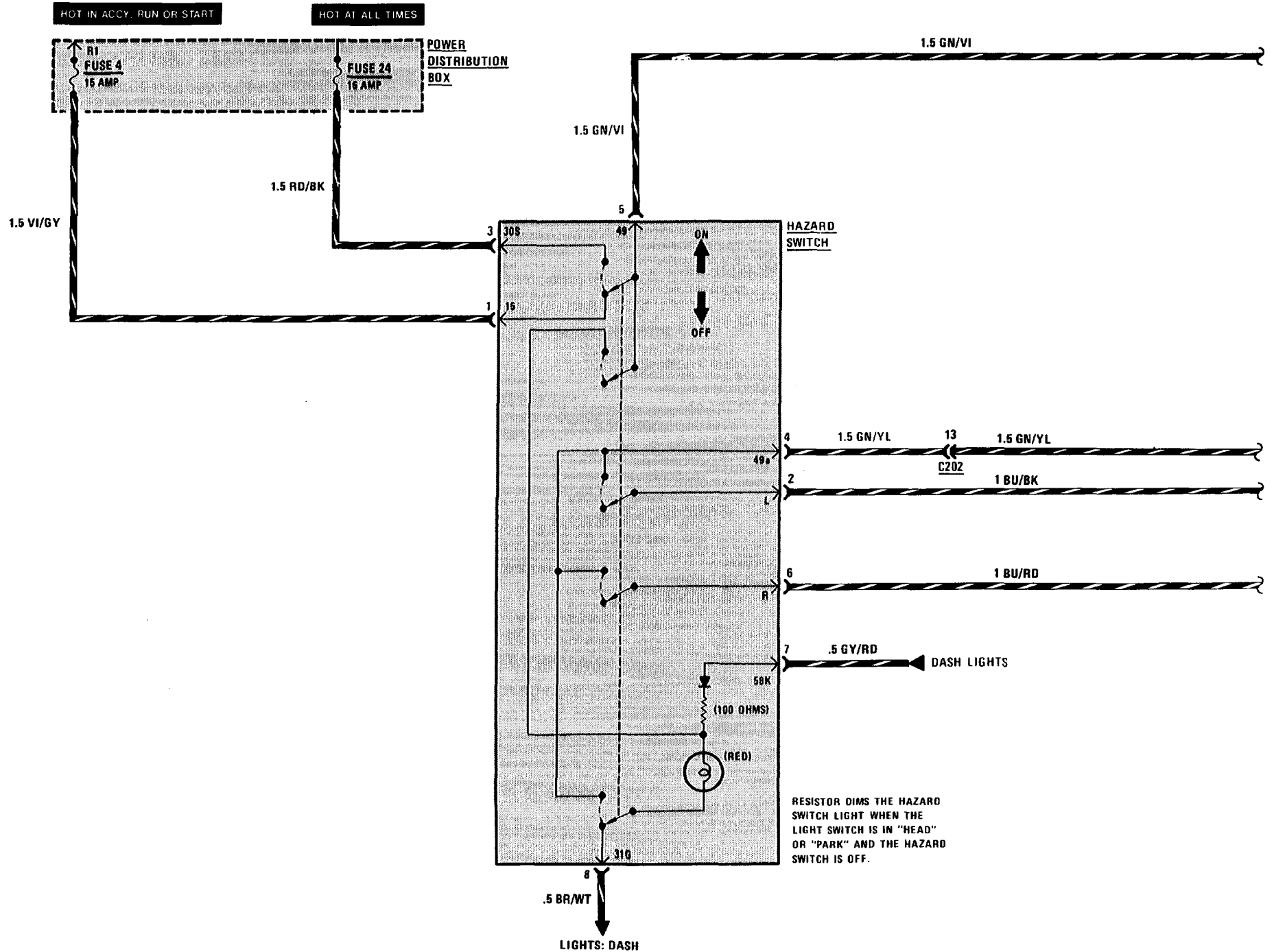



# LIGHTS: TURN/HAZARD WARNING 131

(For Component Locations See Page 209)

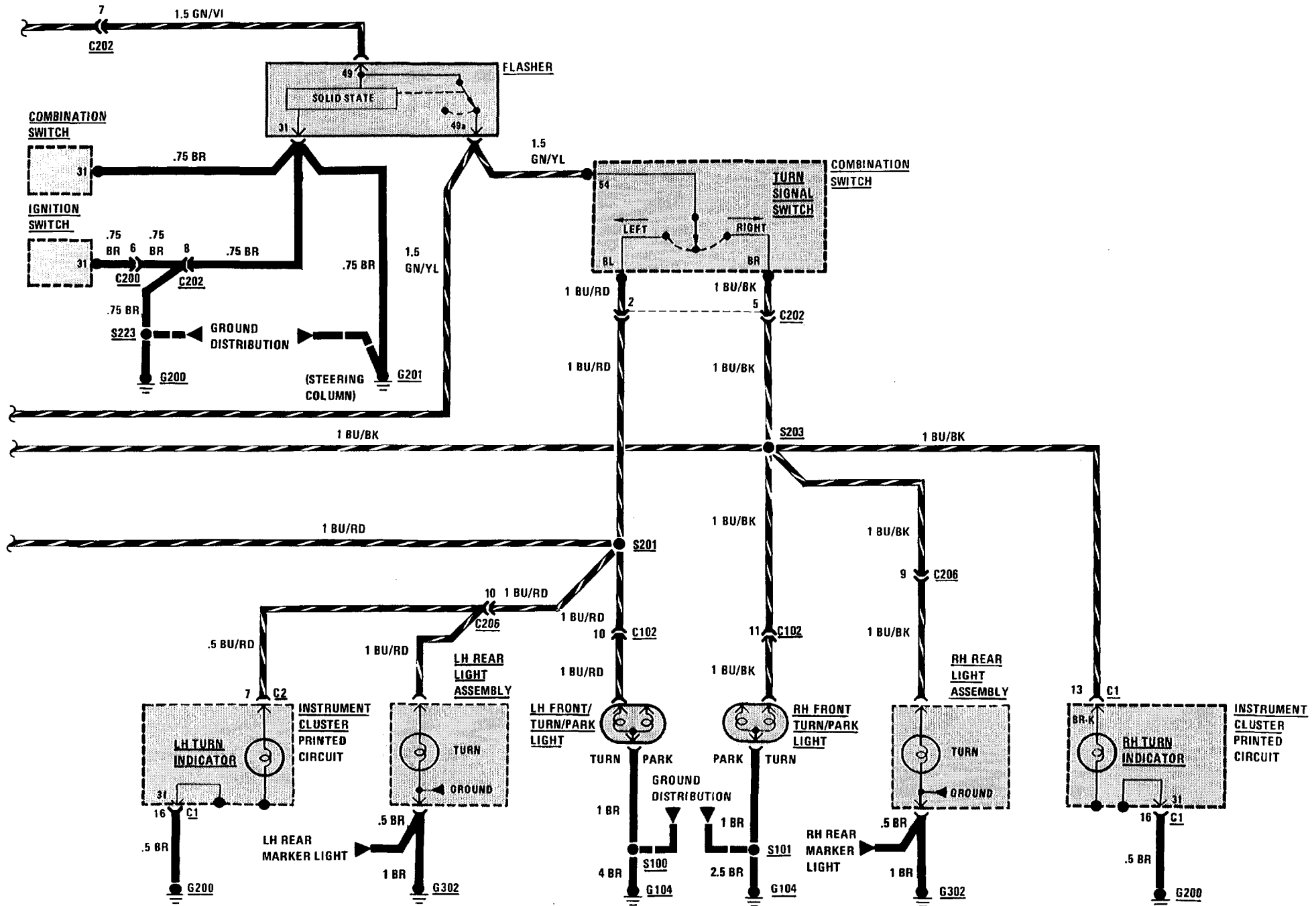

# 132 LIGHTS: FRONT PARK/TAIL/UNDERHOOD

(For Component Locations See Page 208)

HOT AT ALL TIMES

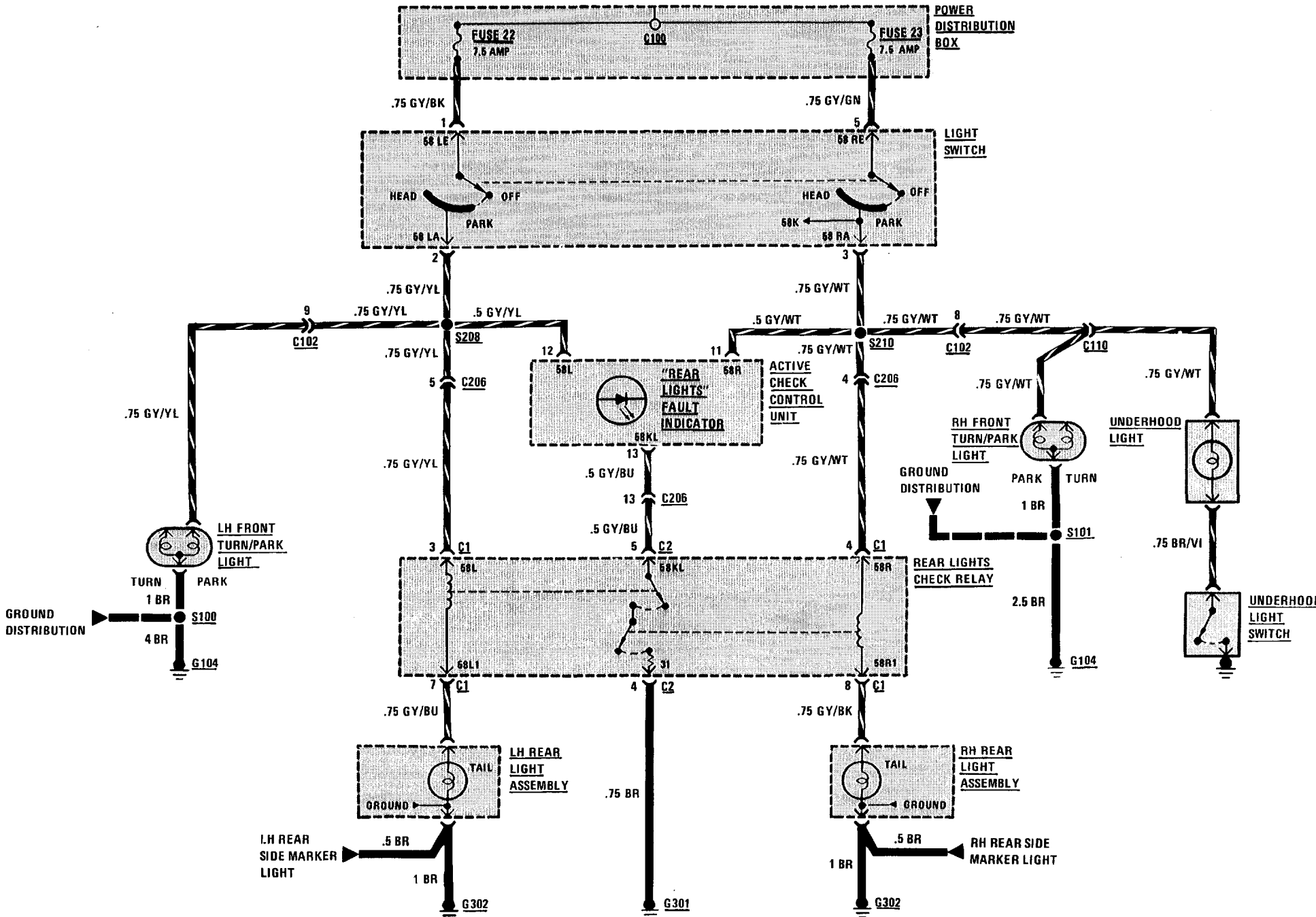

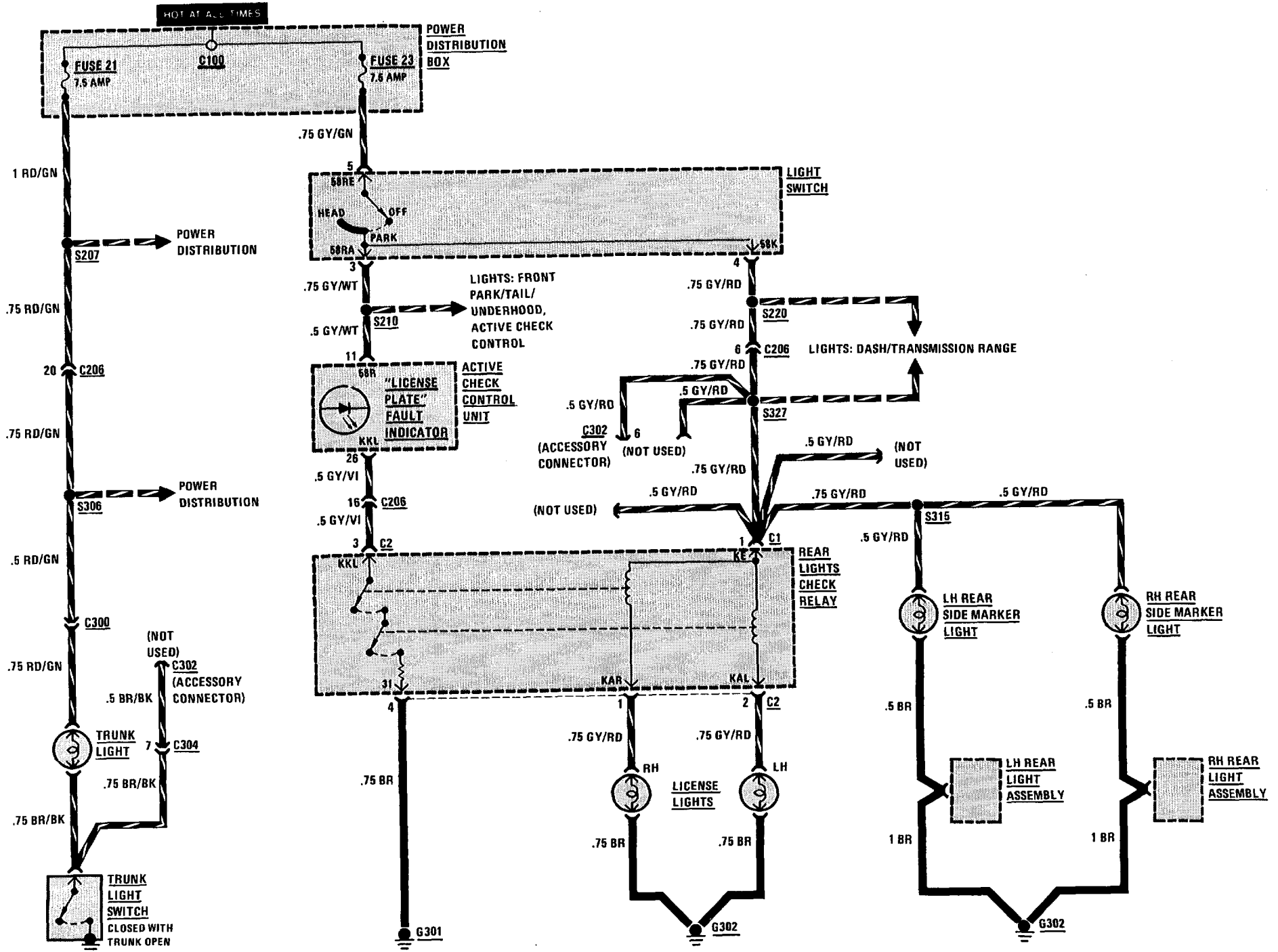

# 134 STOPLIGHTS/CRUISE CONTROL

(For Component Locations See Page 215)

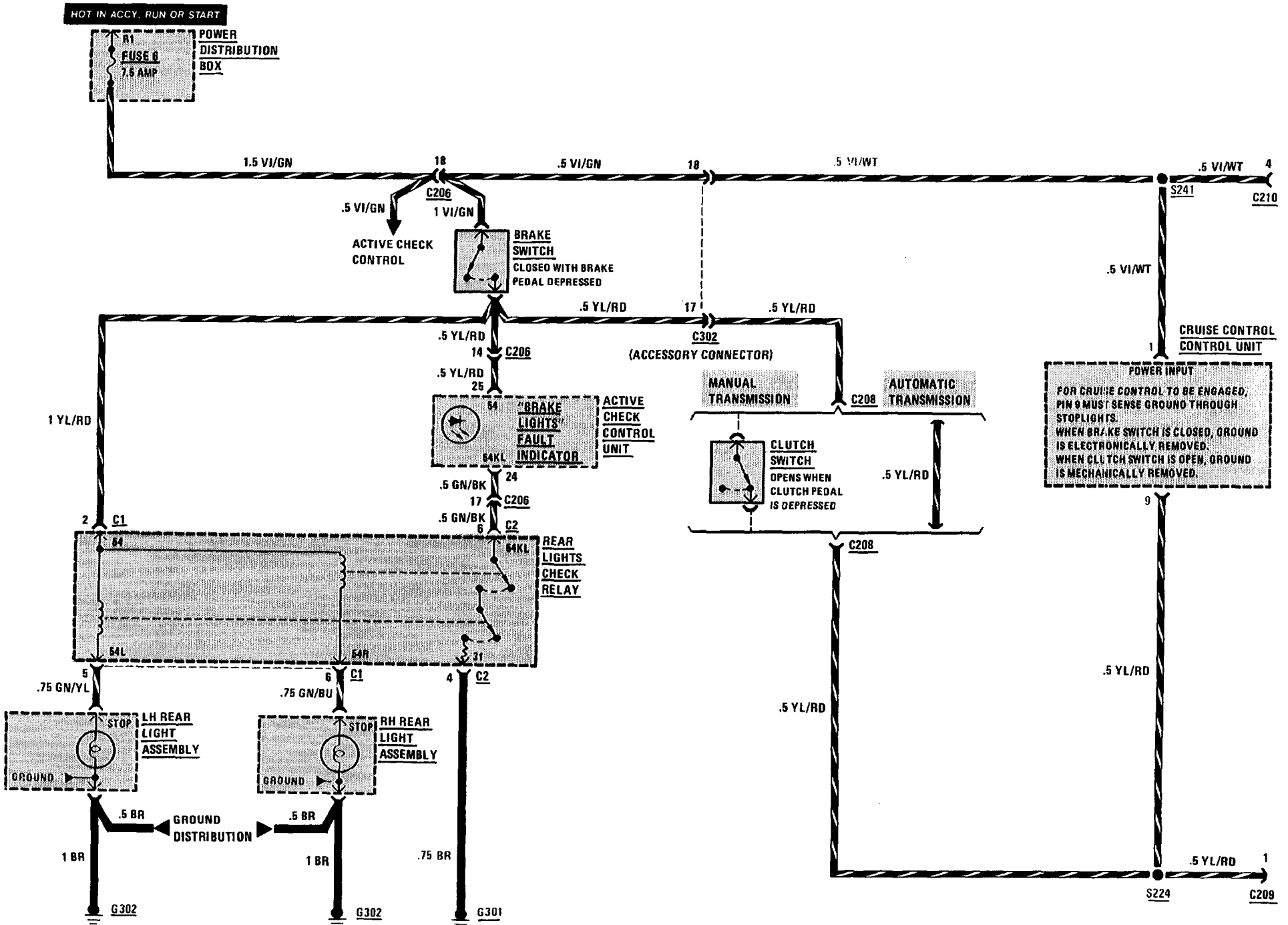

# STOPLIGHTS/CRUISE CONTROL 135

(For Component Locations See Page 215)

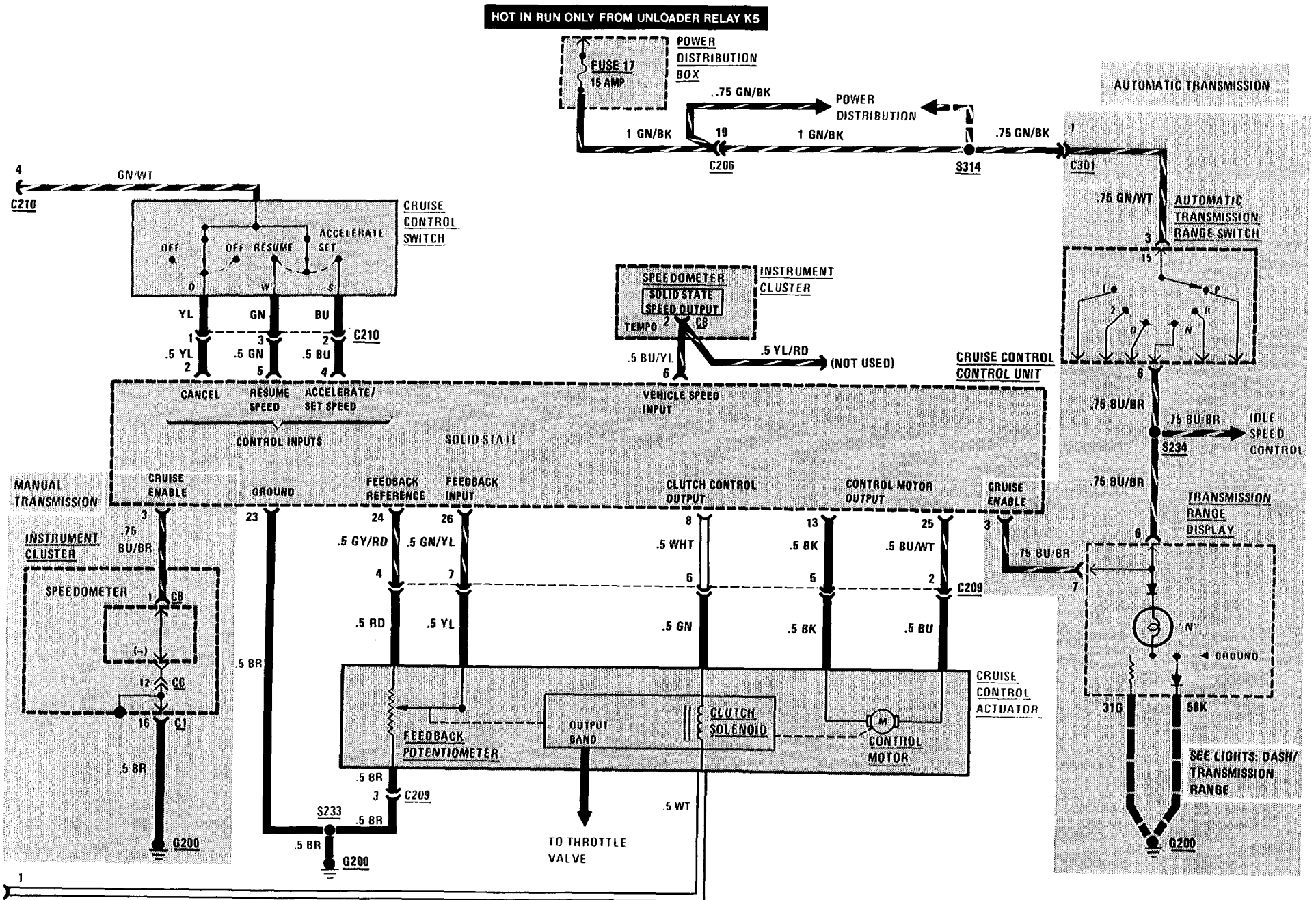

# 136 LIGHTS: RH VISOR/DASH/TRANSMISSION RANGE

(For Component Locations See Page 208)

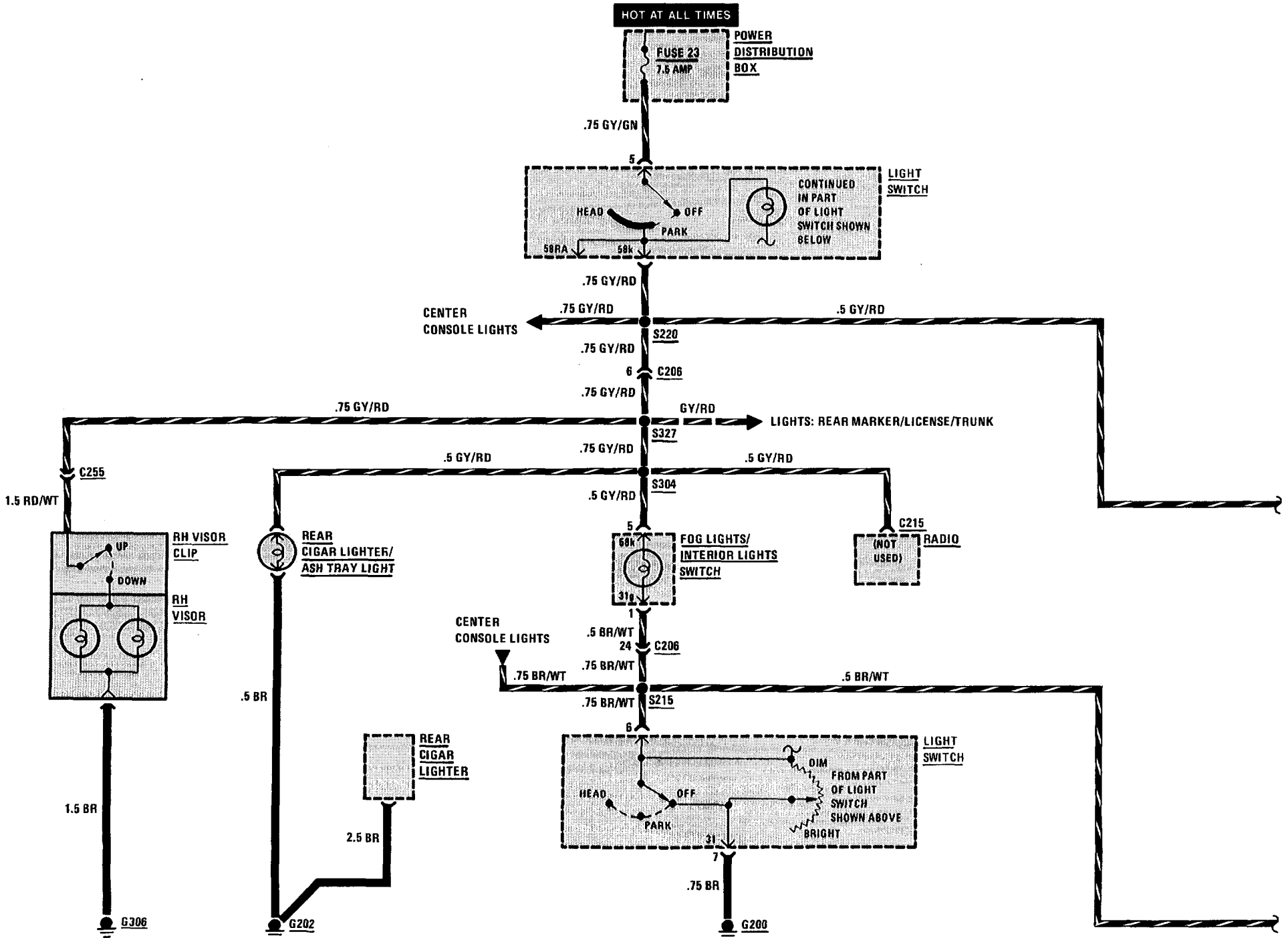

# LIGHTS: DASH/TRANSMISSION RANGE 137

(For Component Locations See Page 208)

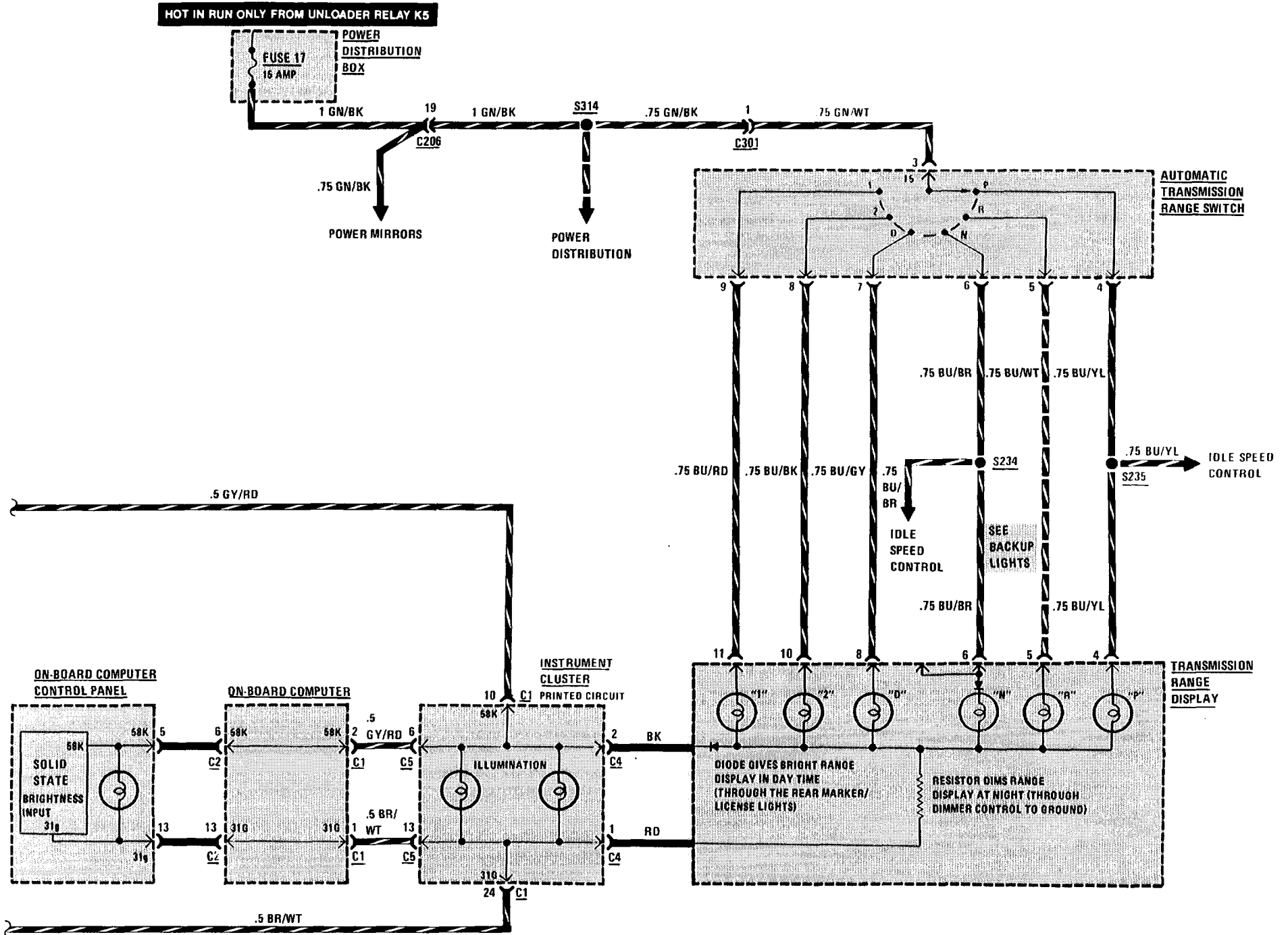

# 138 CENTER CONSOLE LIGHTS

(For Component Locations See Page 203)

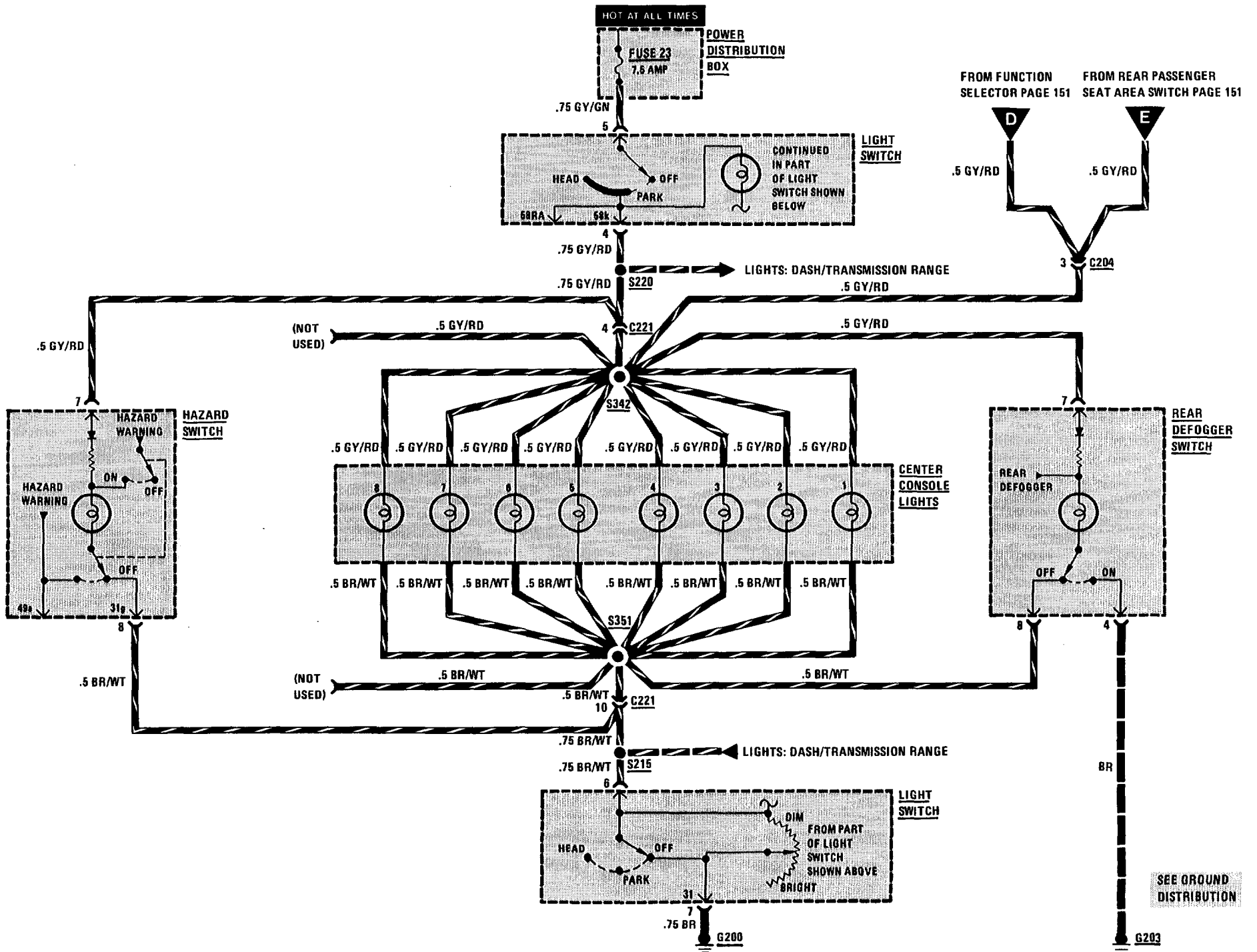



(For Component Locations See Page 202)

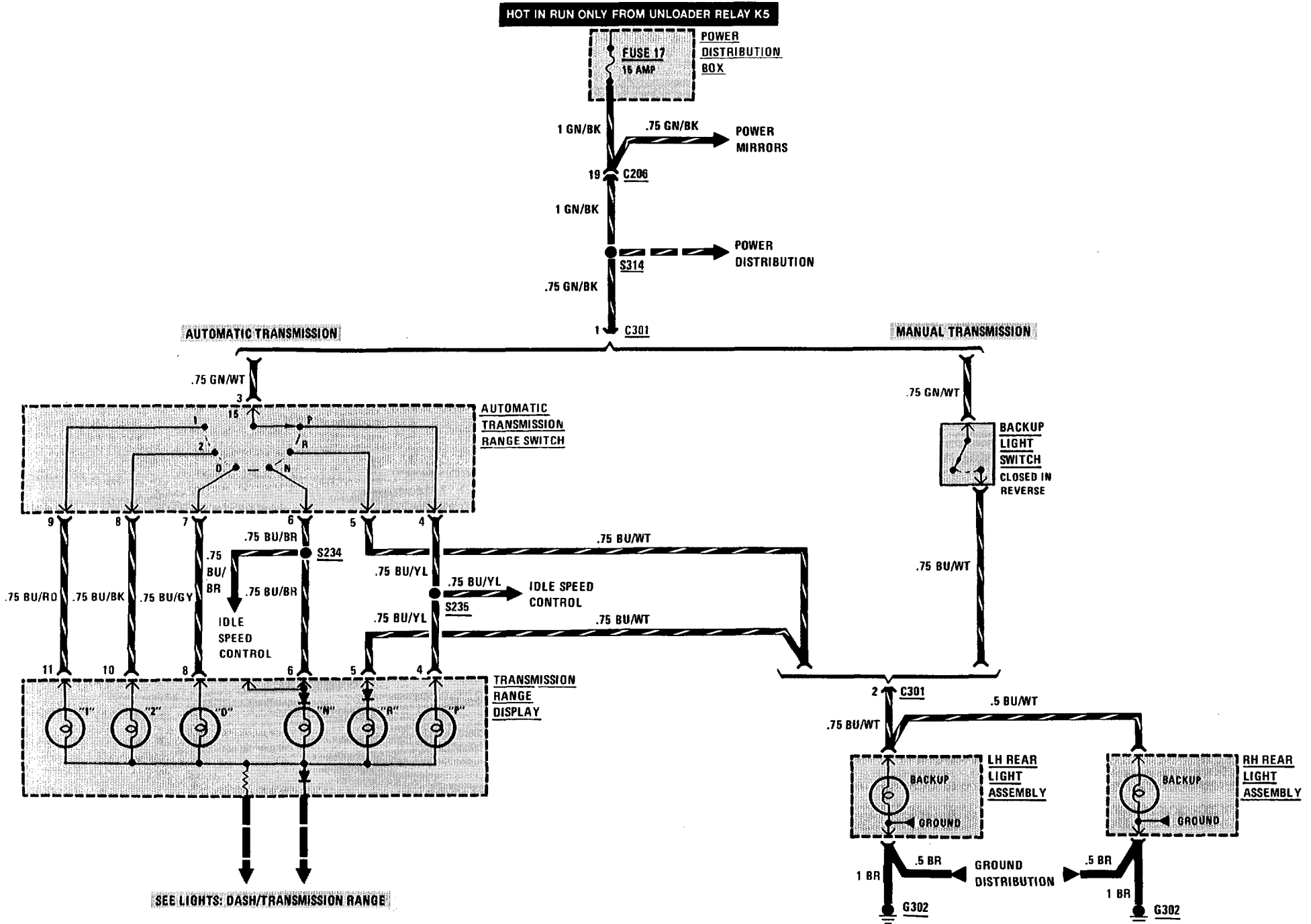

# 140 CIGAR LIGHTER/GLOVEBOX LIGHT/AUTO-CHARGING FLASHLIGHT

(For Component Locations See Page 204)

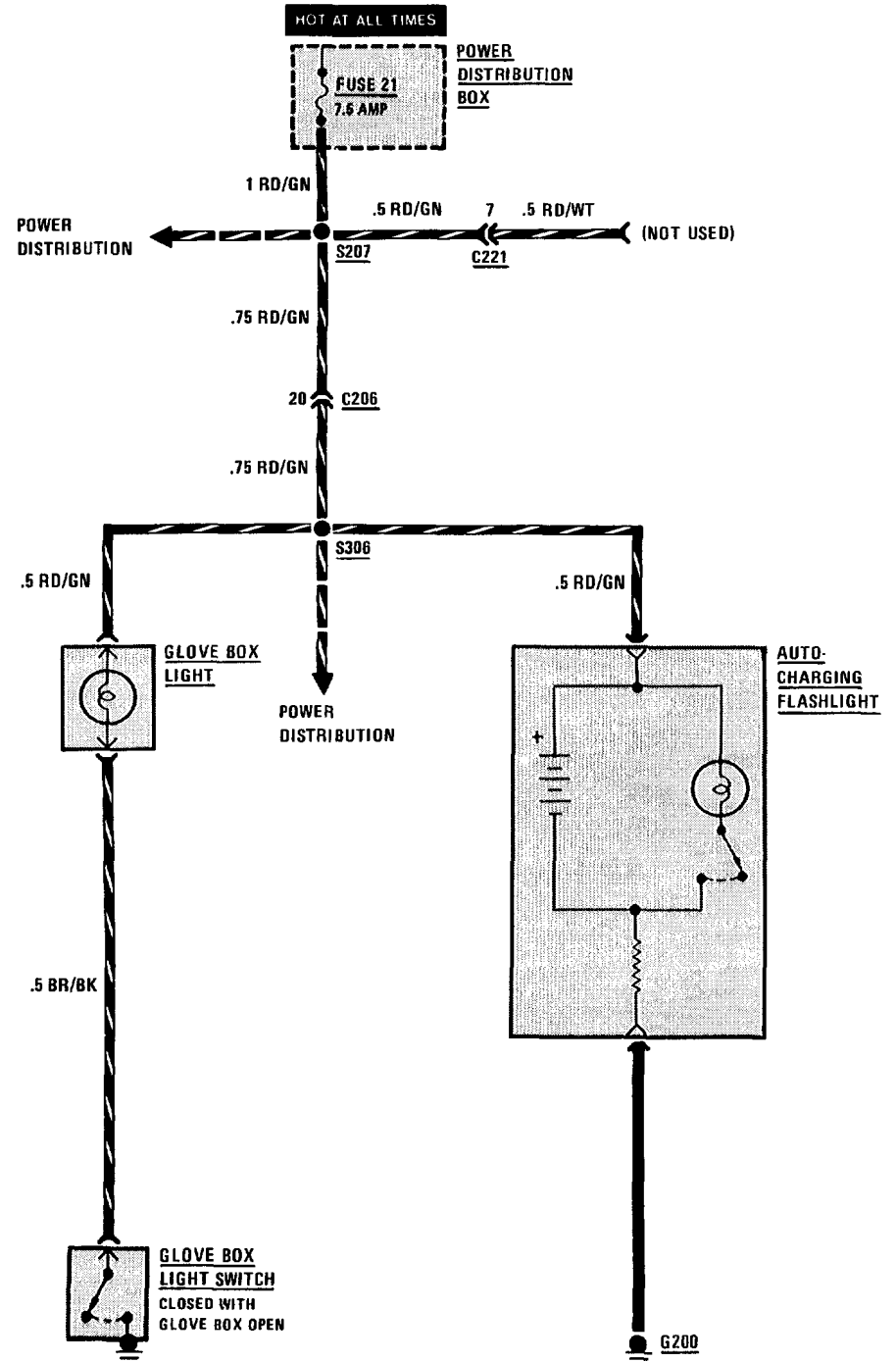
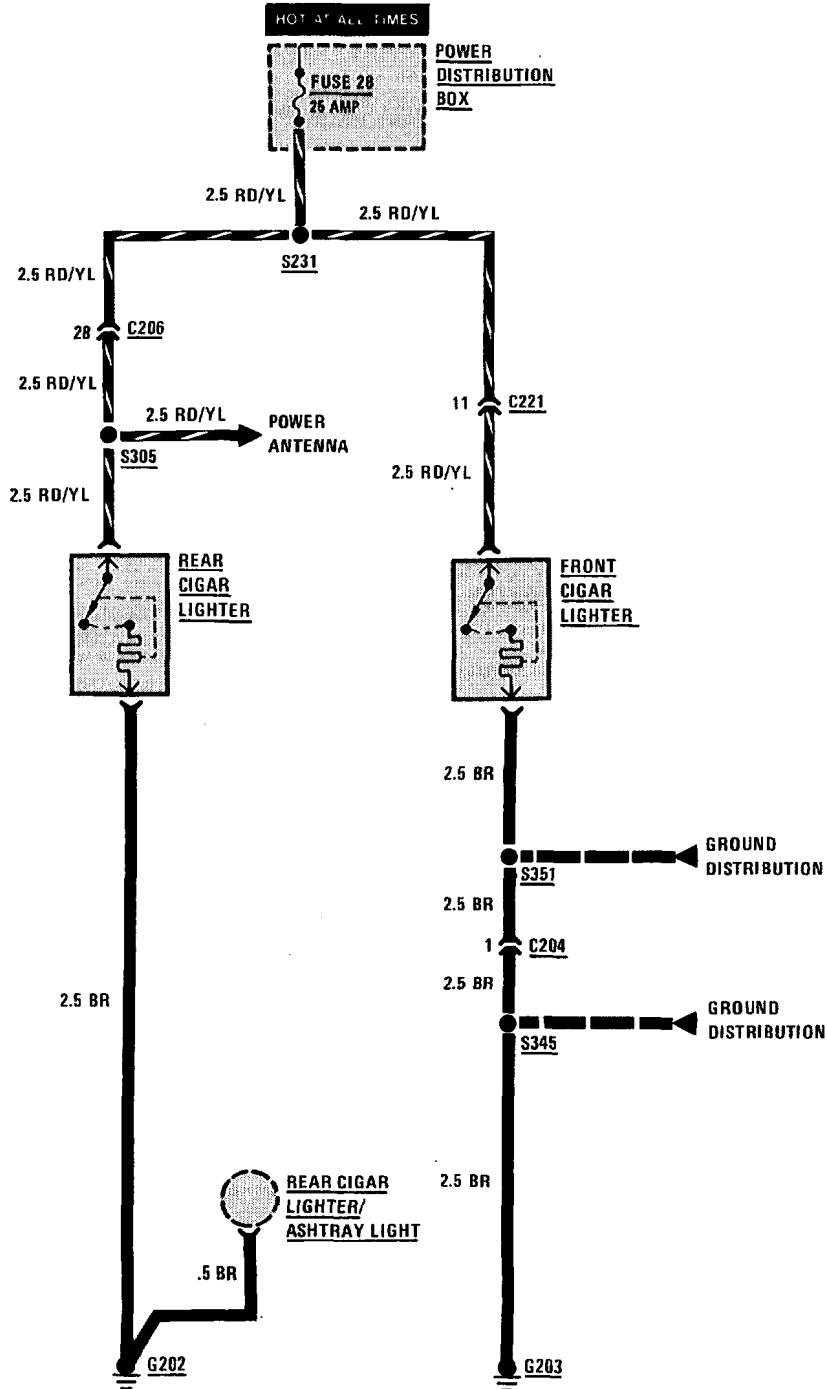

(For Component Locations See Page 211)

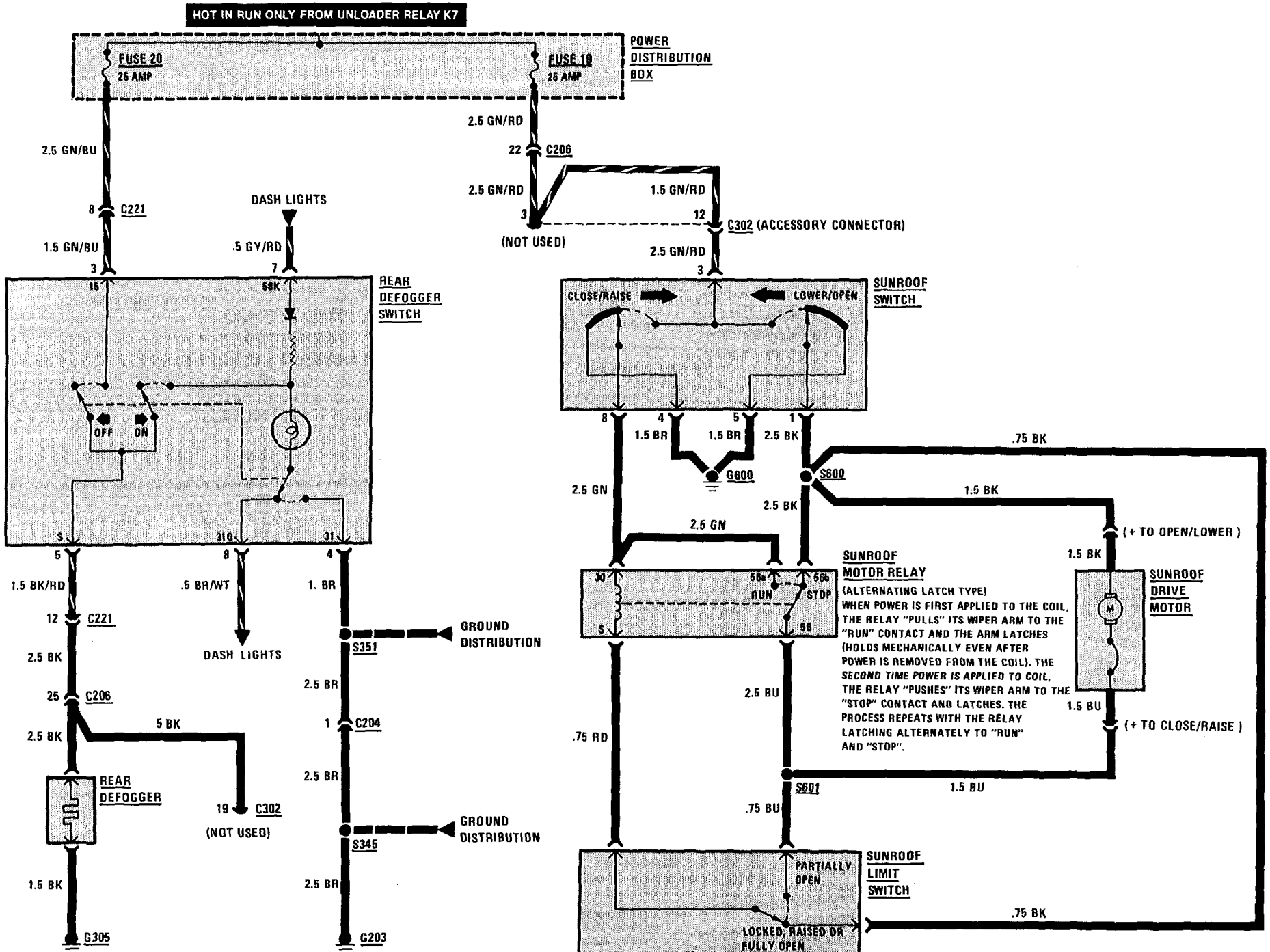

# 142 POWER WINDOWS

(For Component Locations See Page 210)

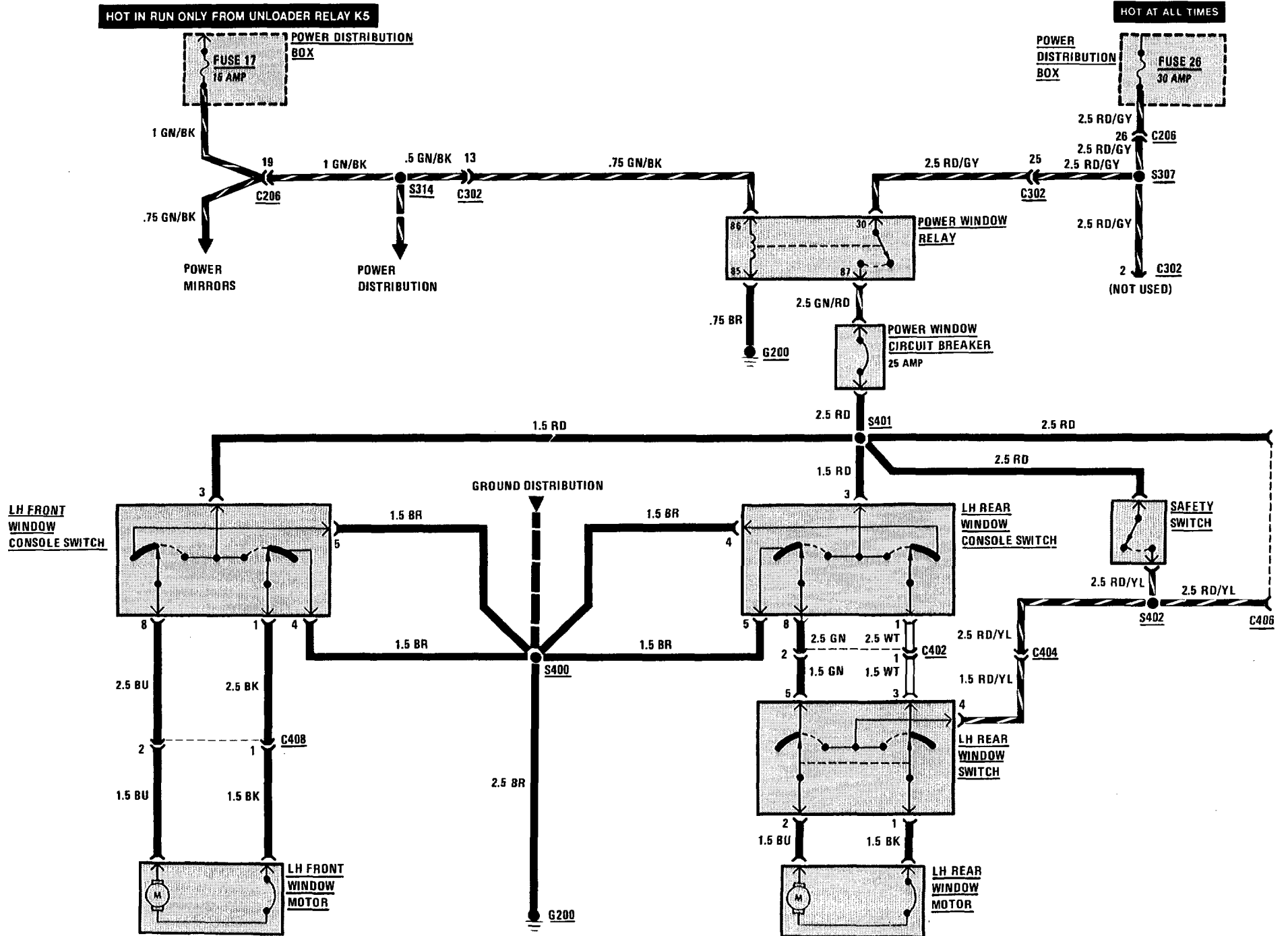

(For Component Locations See Page 210)

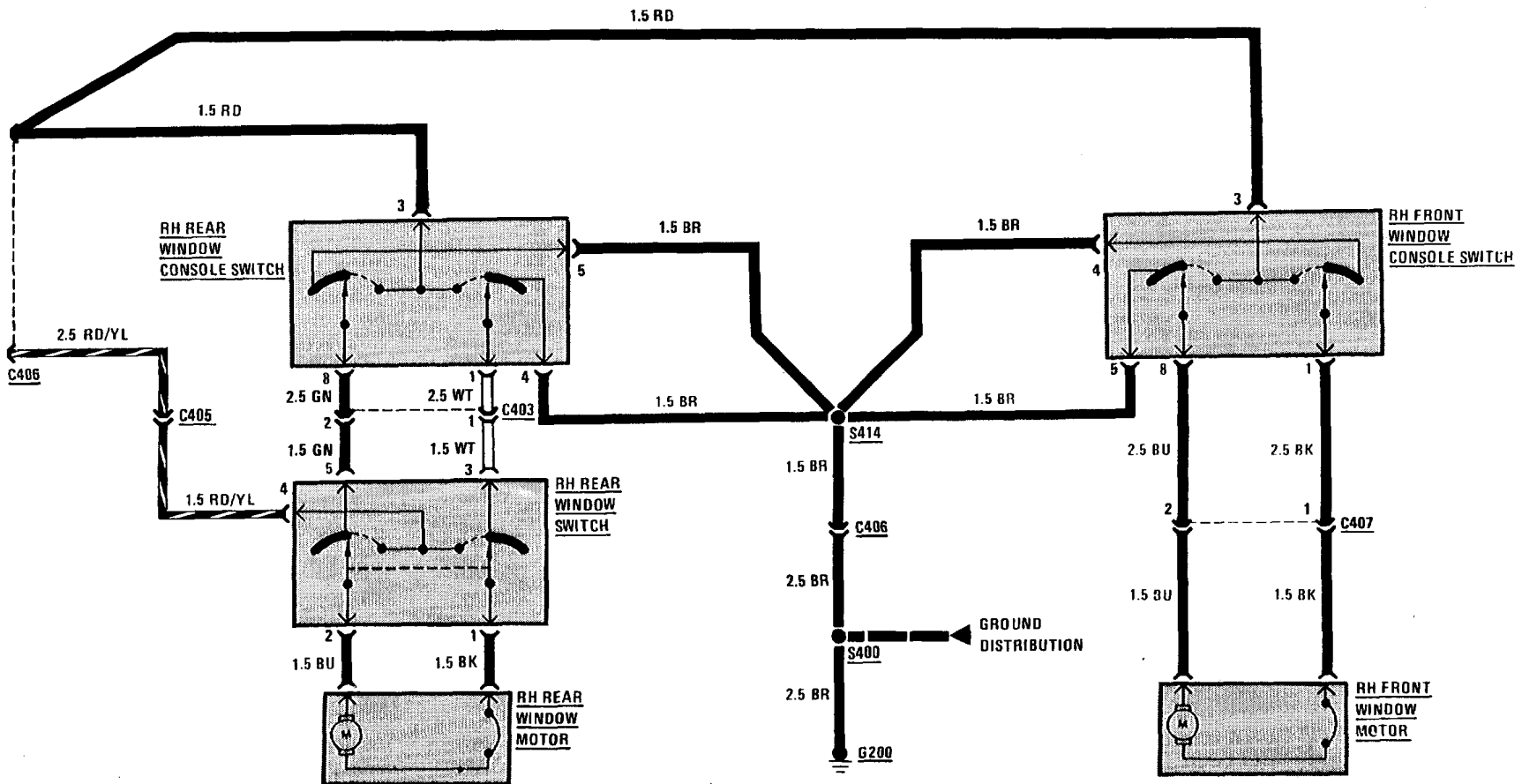

# 144 CENTRAL LOCKING (SELECT)

(For Component Locations See Page 203)

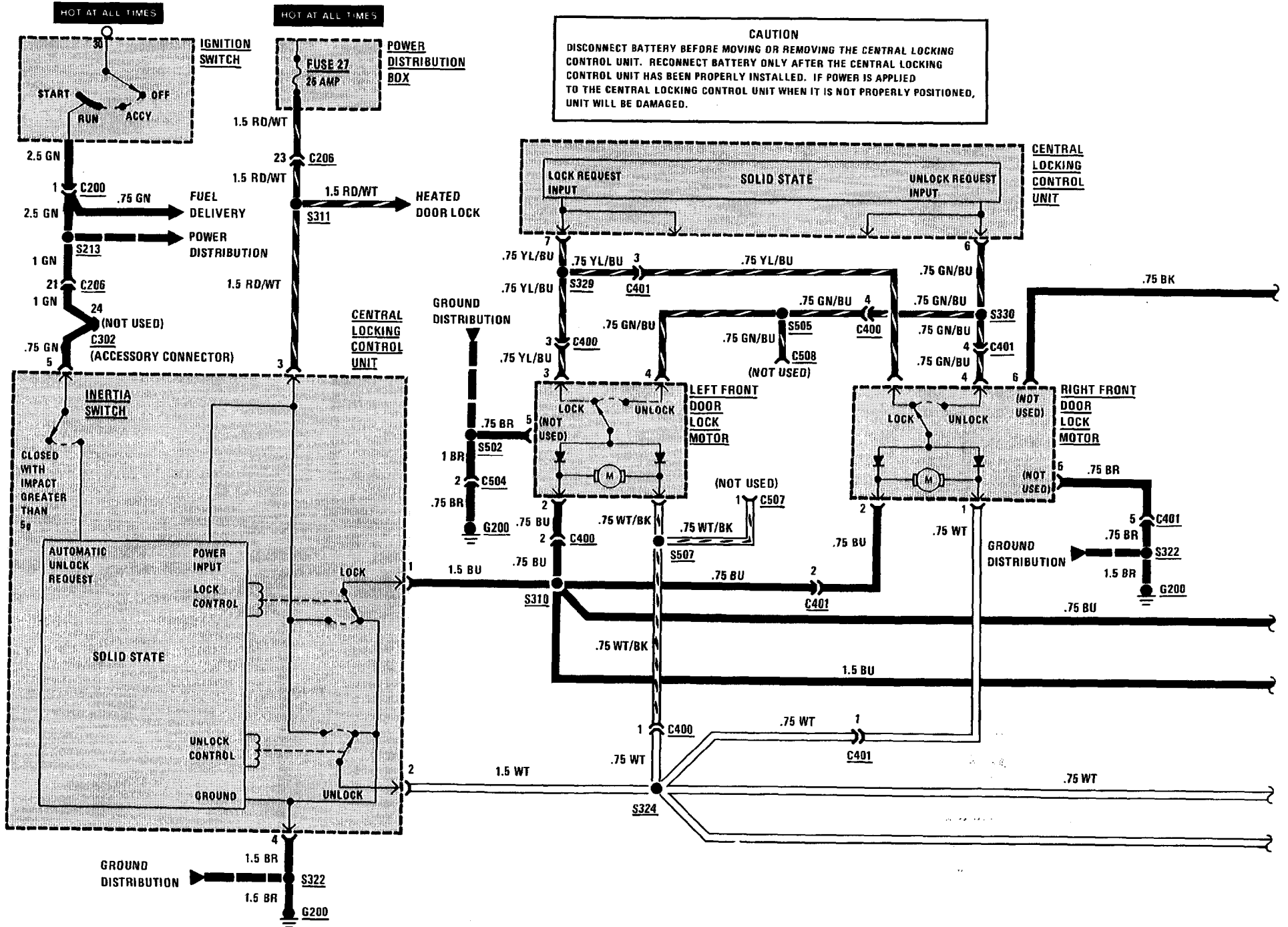

(For Component Locations See Page 203)

**CAUTION**

DO NOT OPERATE THE SYSTEM MORE THAN 8 TIMES IN QUICK SUCCESSION TO PREVENT DAMAGE TO THE CONTROL UNIT.

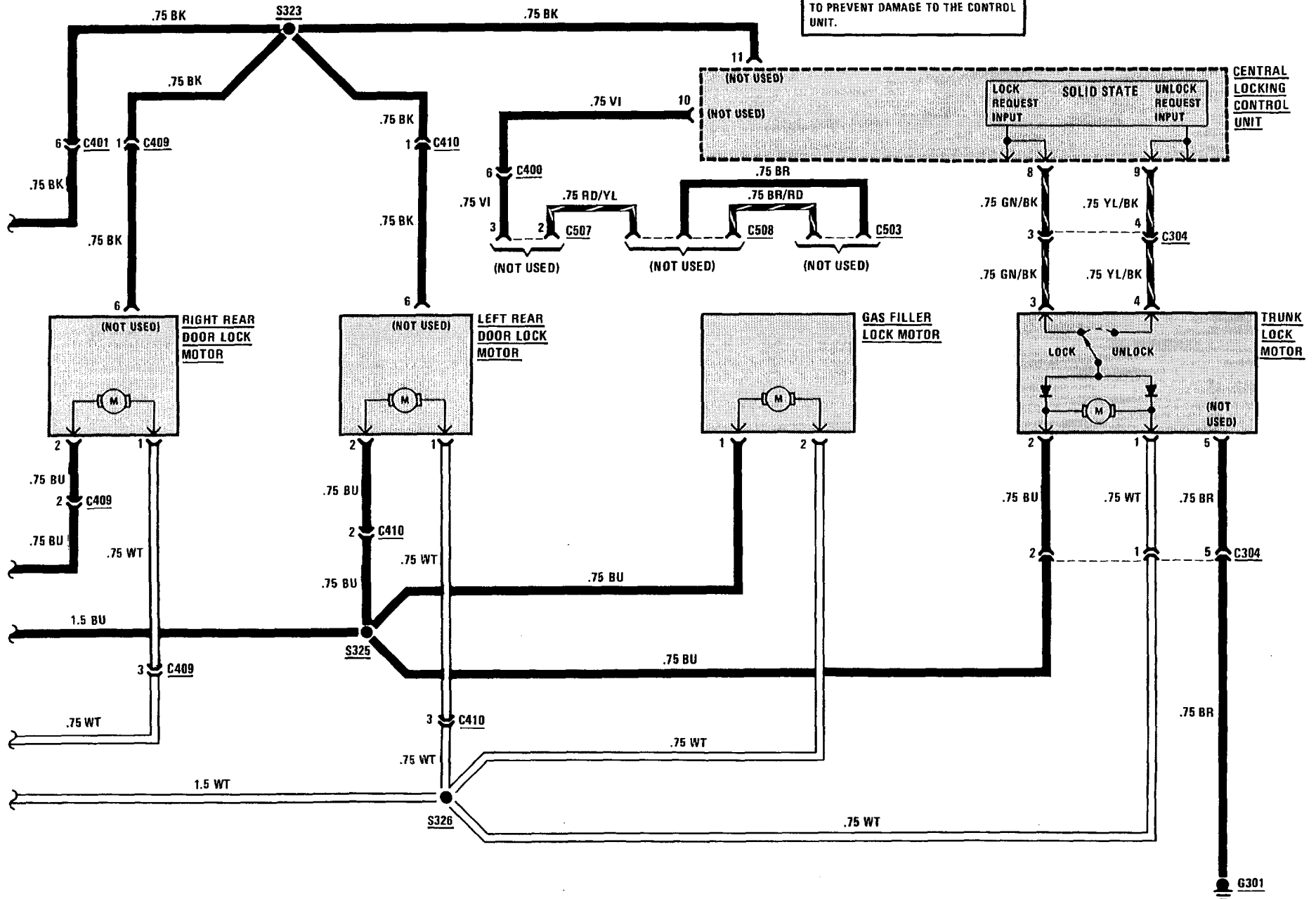

# 146 POWER MIRRORS

(For Component Locations See Page 210)

**HOT IN RUN ONLY FROM UNLOADER RELAY K5**

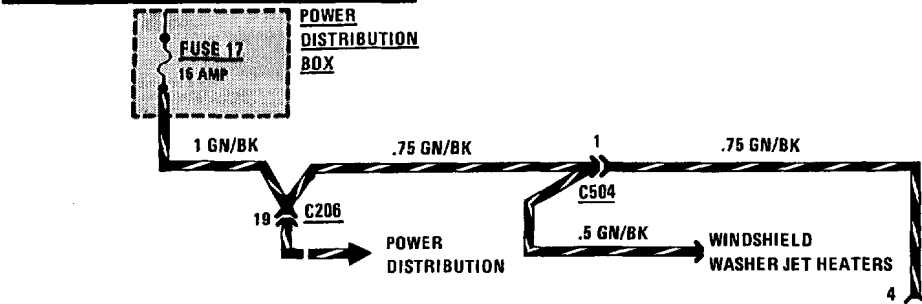

1. MOTOR DIRECTION CONTROLLED BY POLARITY
2. WITH CLUTCH SOLENOID ENERGIZED MOTOR TURNS MIRROR LEFT OR RIGHT
3. ELECTRICALLY HEATED MIRROR TURNS ON BELOW  $59 \pm 9^\circ \text{ F}$  AND TURNS OFF ABOVE  $122 \pm 18^\circ \text{ F}$

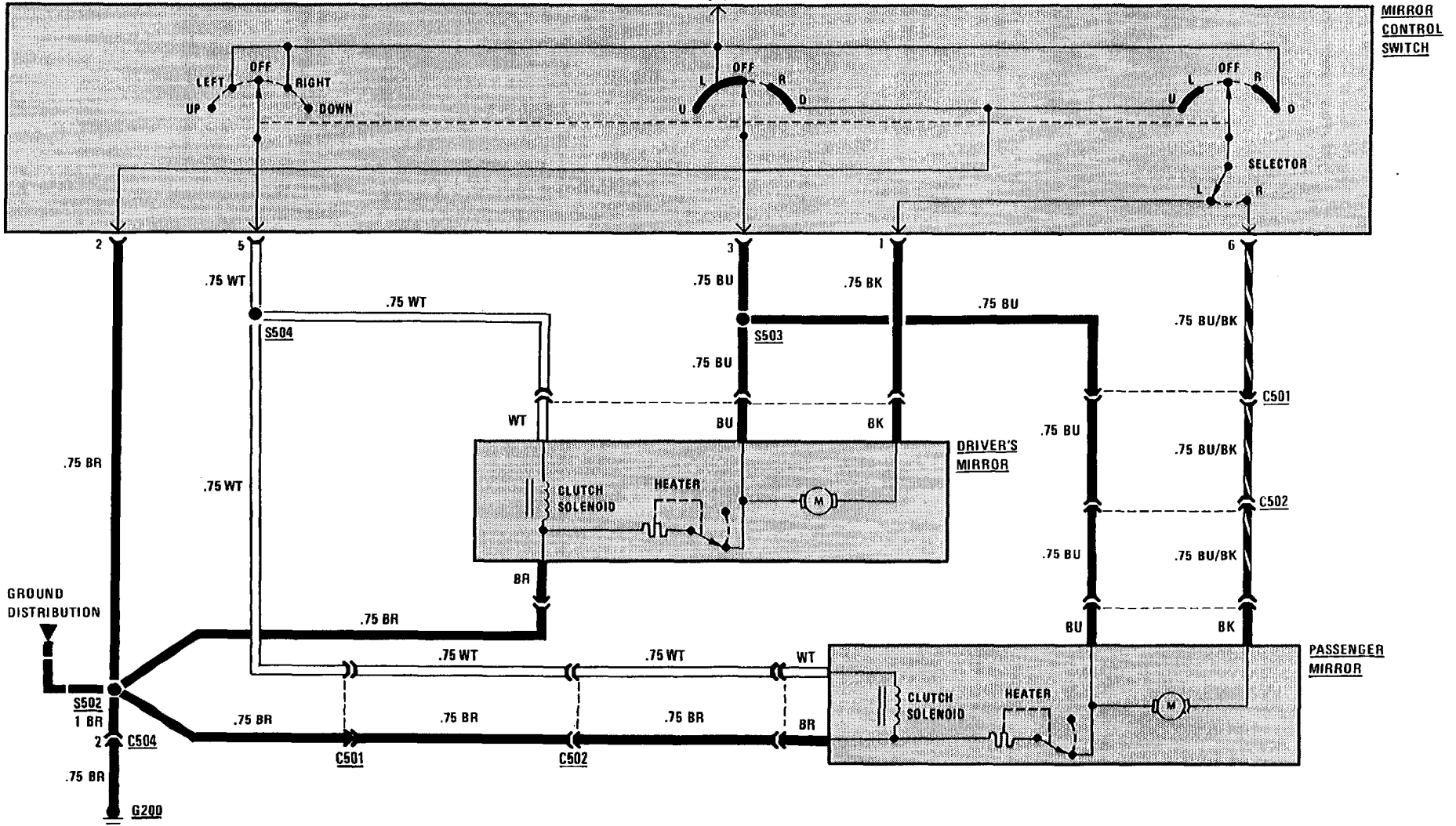

**MIRROR CONTROL SWITCH**



(For Component Locations See Page 211)

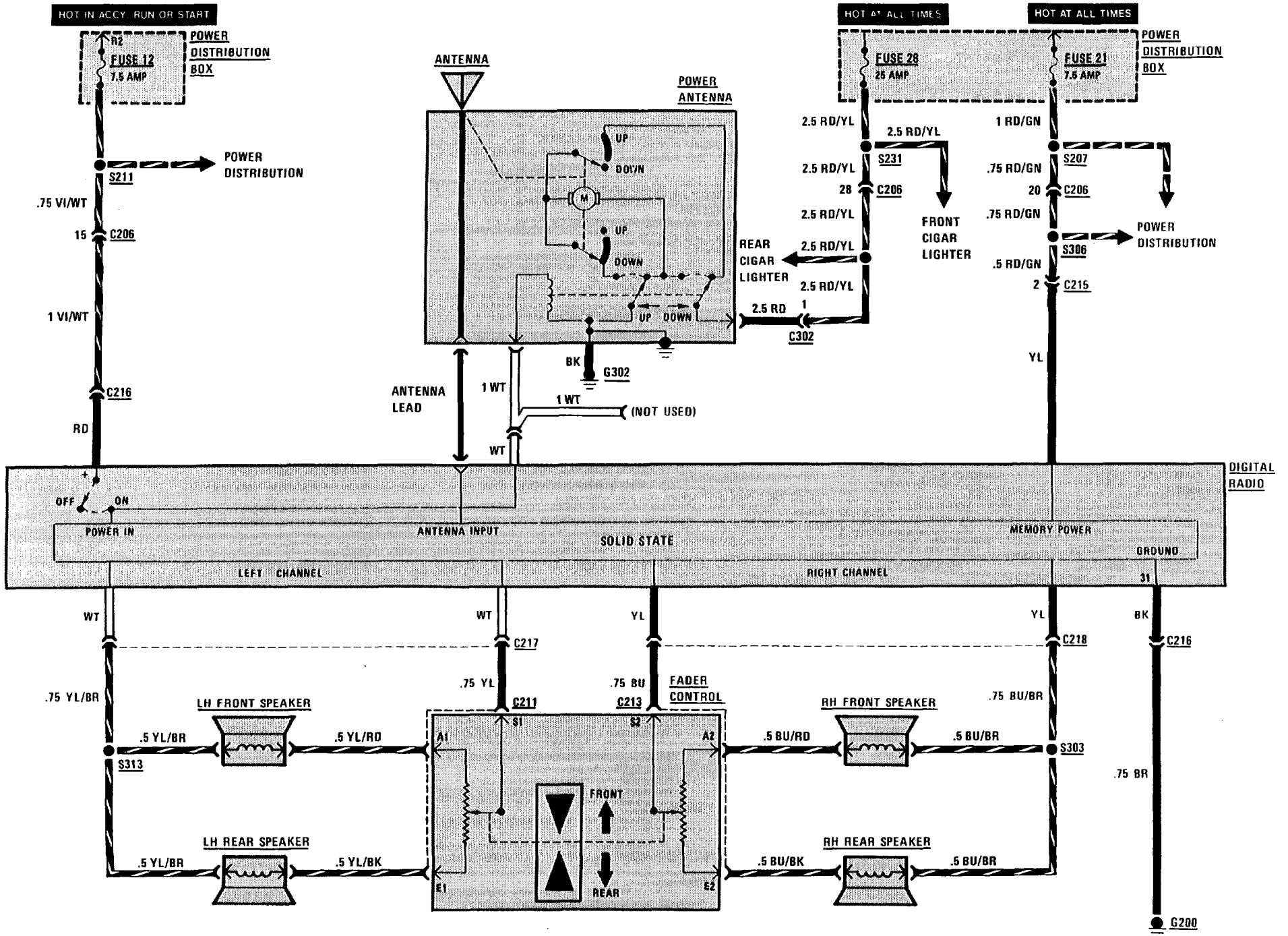

# 148 AUXILIARY FAN/VACUUM PUMP

(For Component Locations See Page 202)

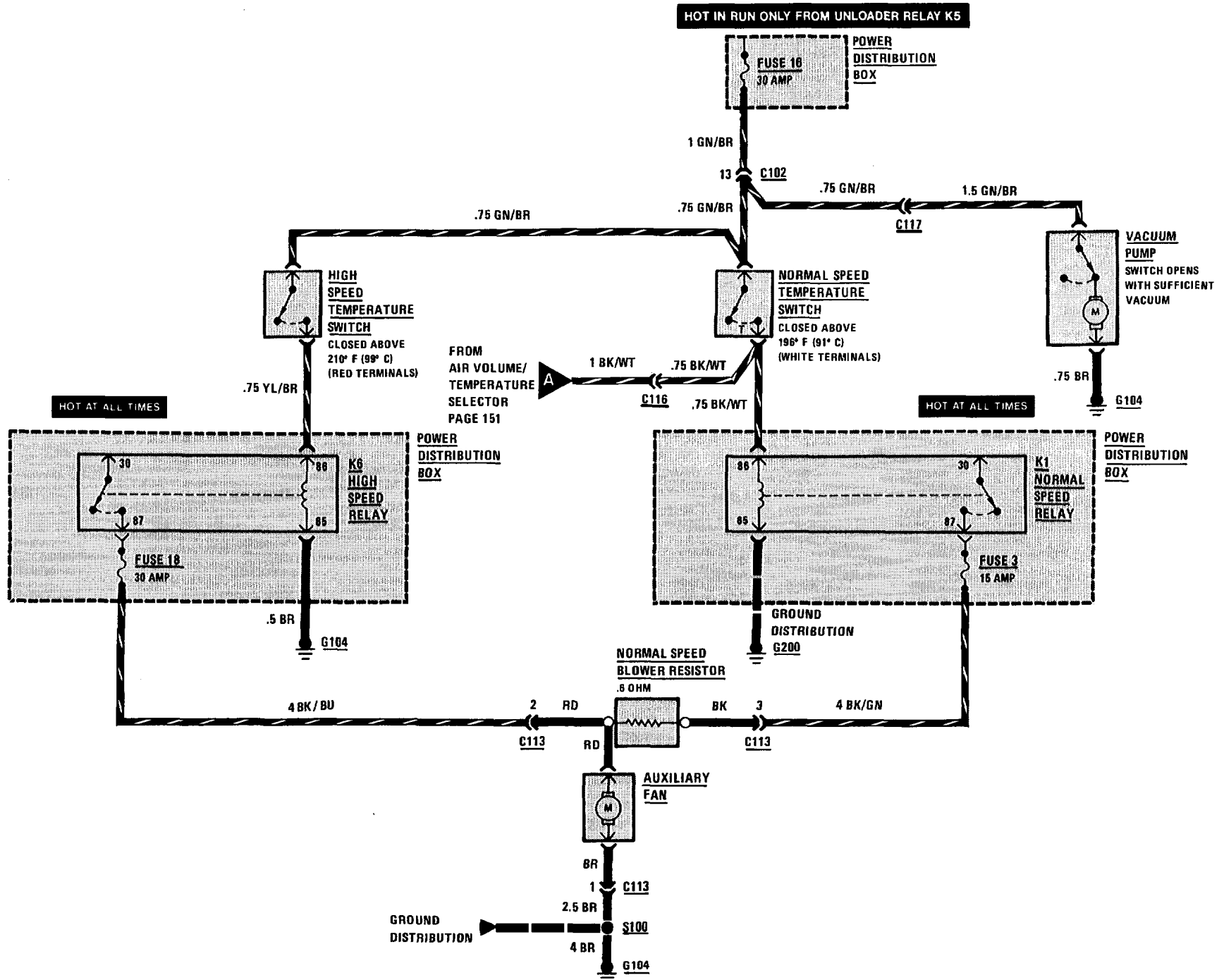

(For Component Locations See Page 201)

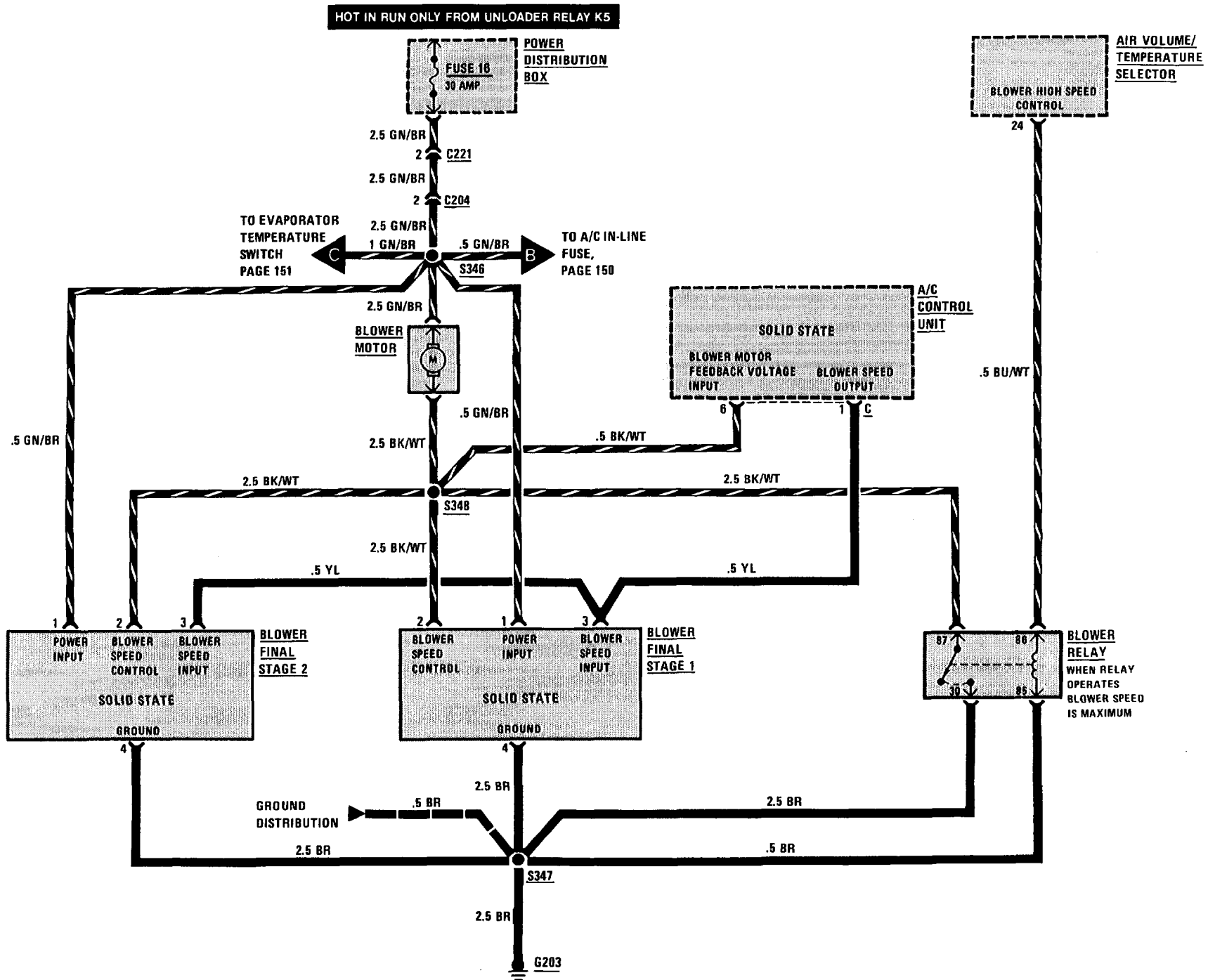

# 150 AUTOMATIC HEATER-AIR CONDITIONER (AIR CONTROL)

(For Component Locations See Page 201)

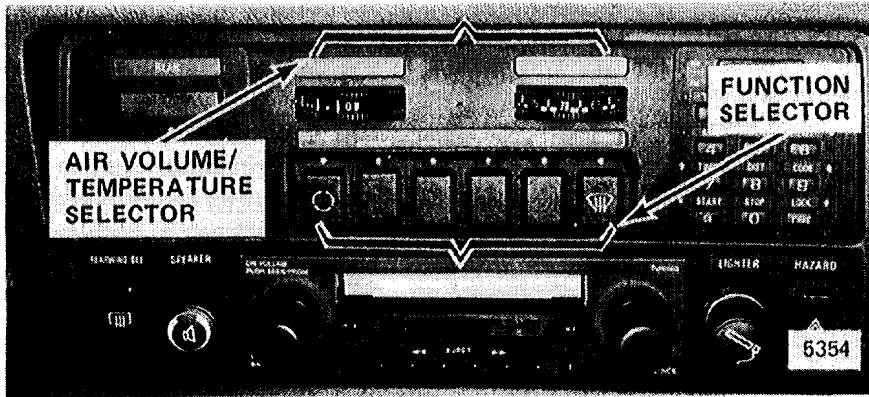
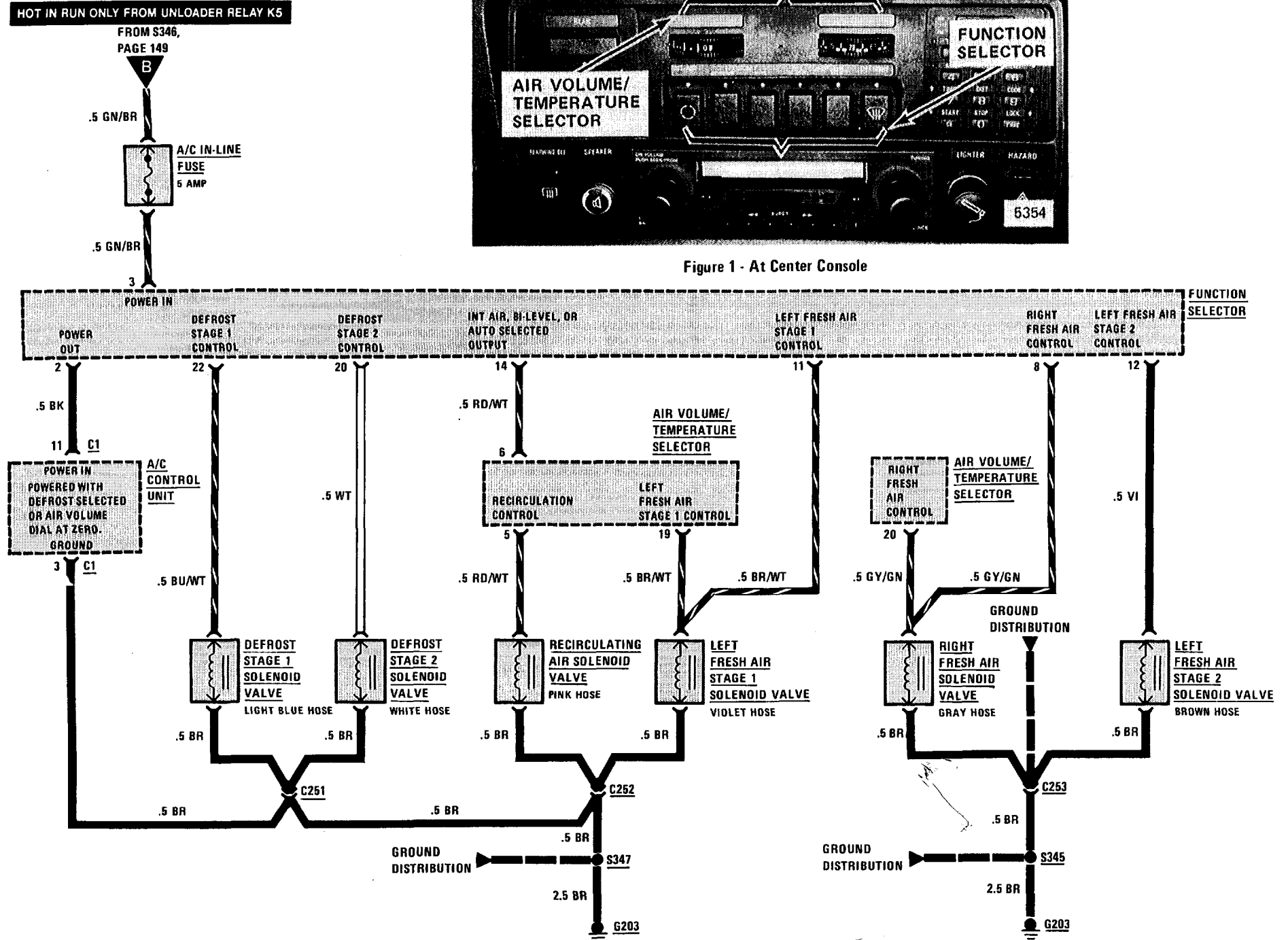
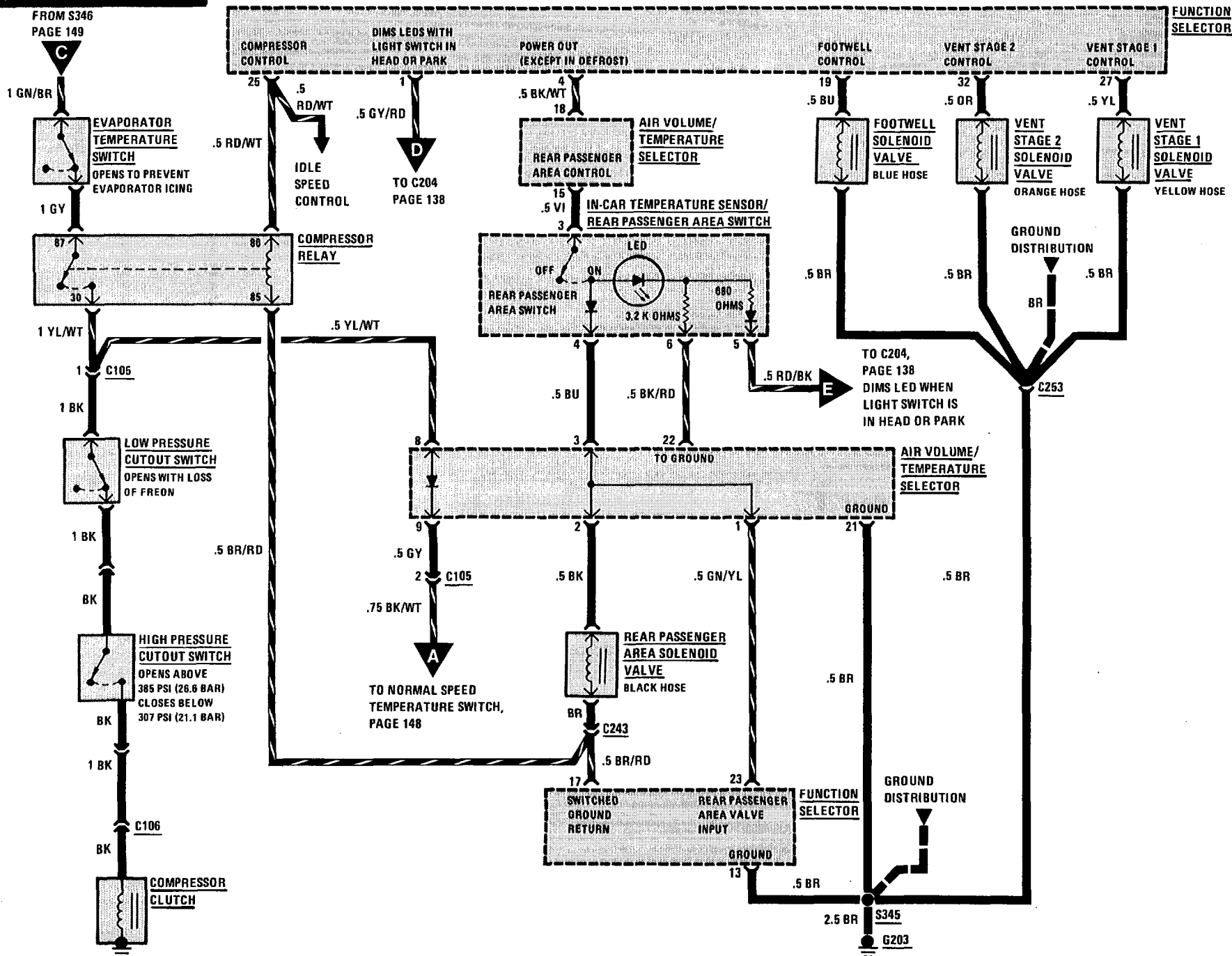

Figure 1 - At Center Console



(For Component Locations See Page 201)

**HOT IN RUN ONLY FROM UNLOADER RELAY K5**



# 152 AUTOMATIC HEATER-AIR CONDITIONER (TEMPERATURE CONTROL)

(For Component Locations See Page 201)

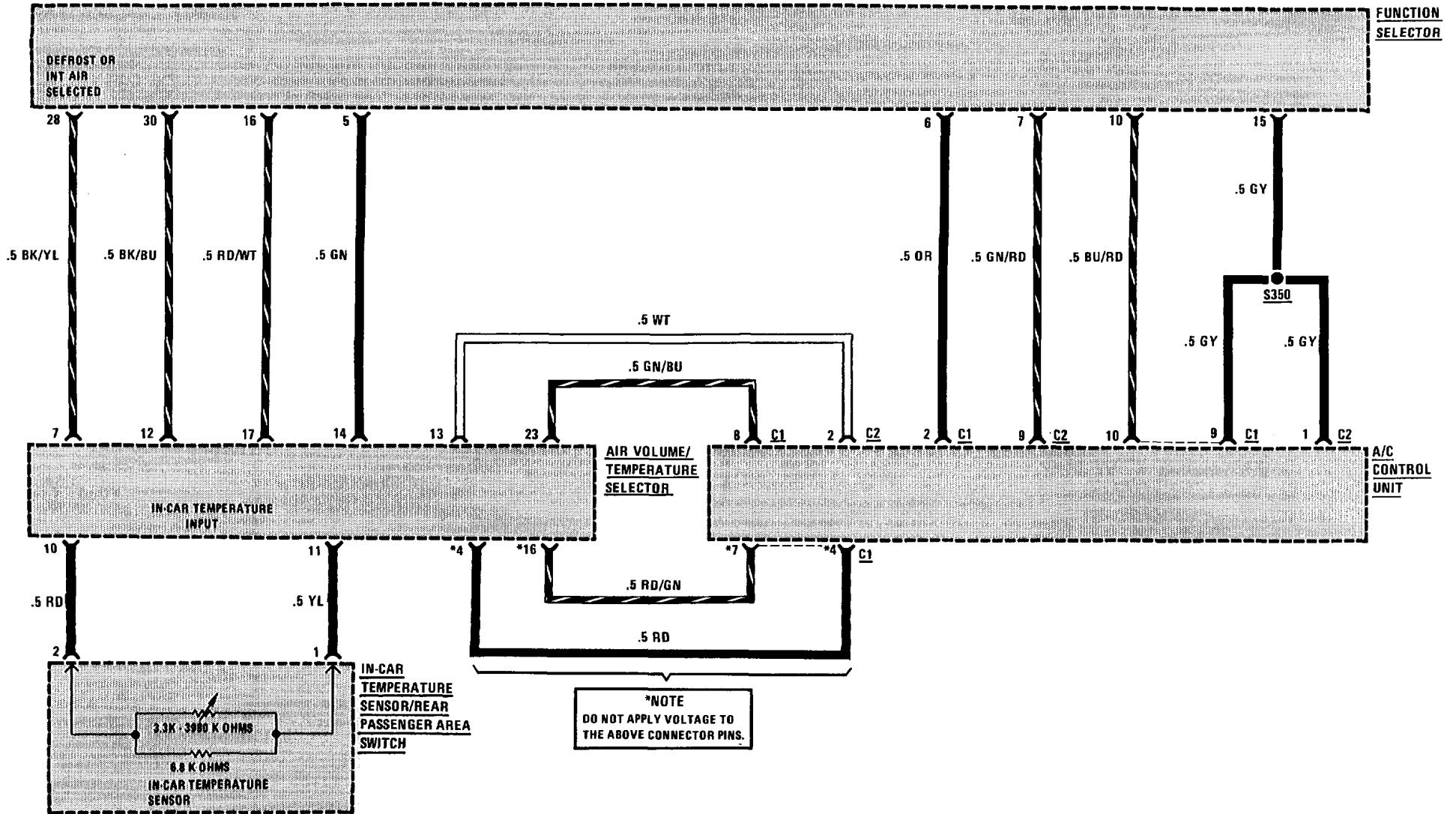

# AUTOMATIC HEATER-AIR CONDITIONER (TEMPERATURE CONTROL) 153

(For Component Locations See Page 201)

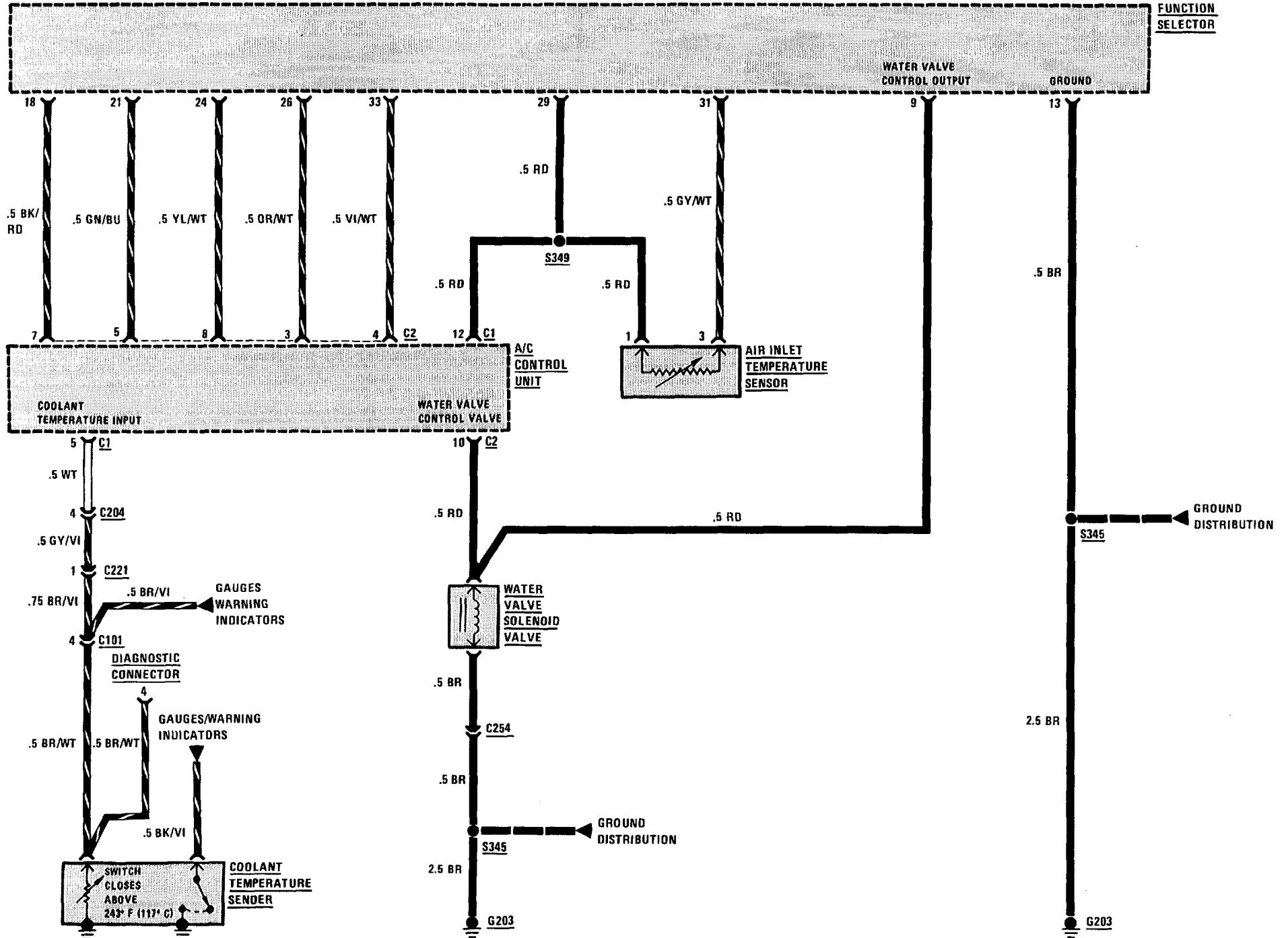

# HORN

(For Component Locations See Page 206)

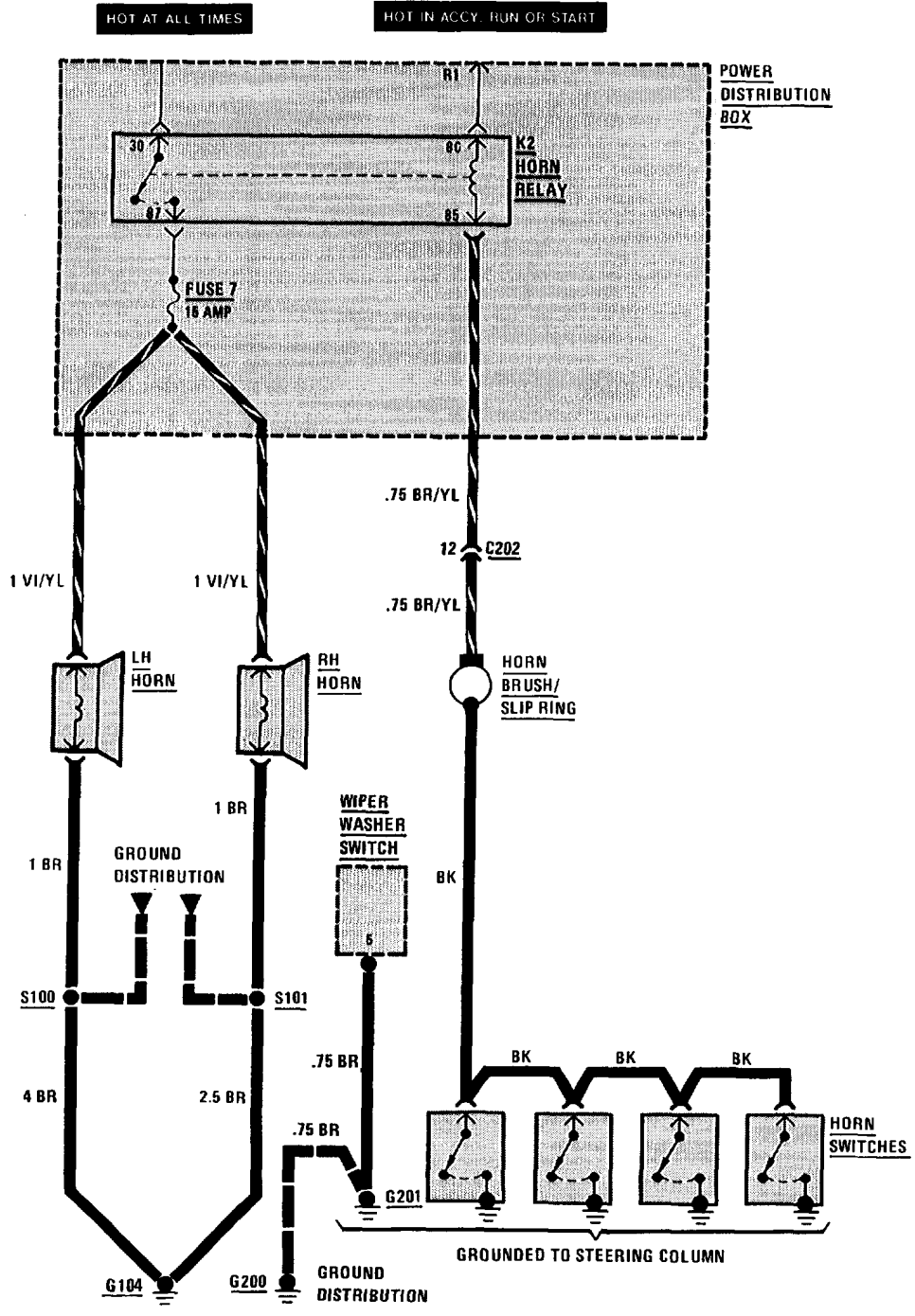

# HEATED DOOR LOCK

(For Component Locations See Page 206)

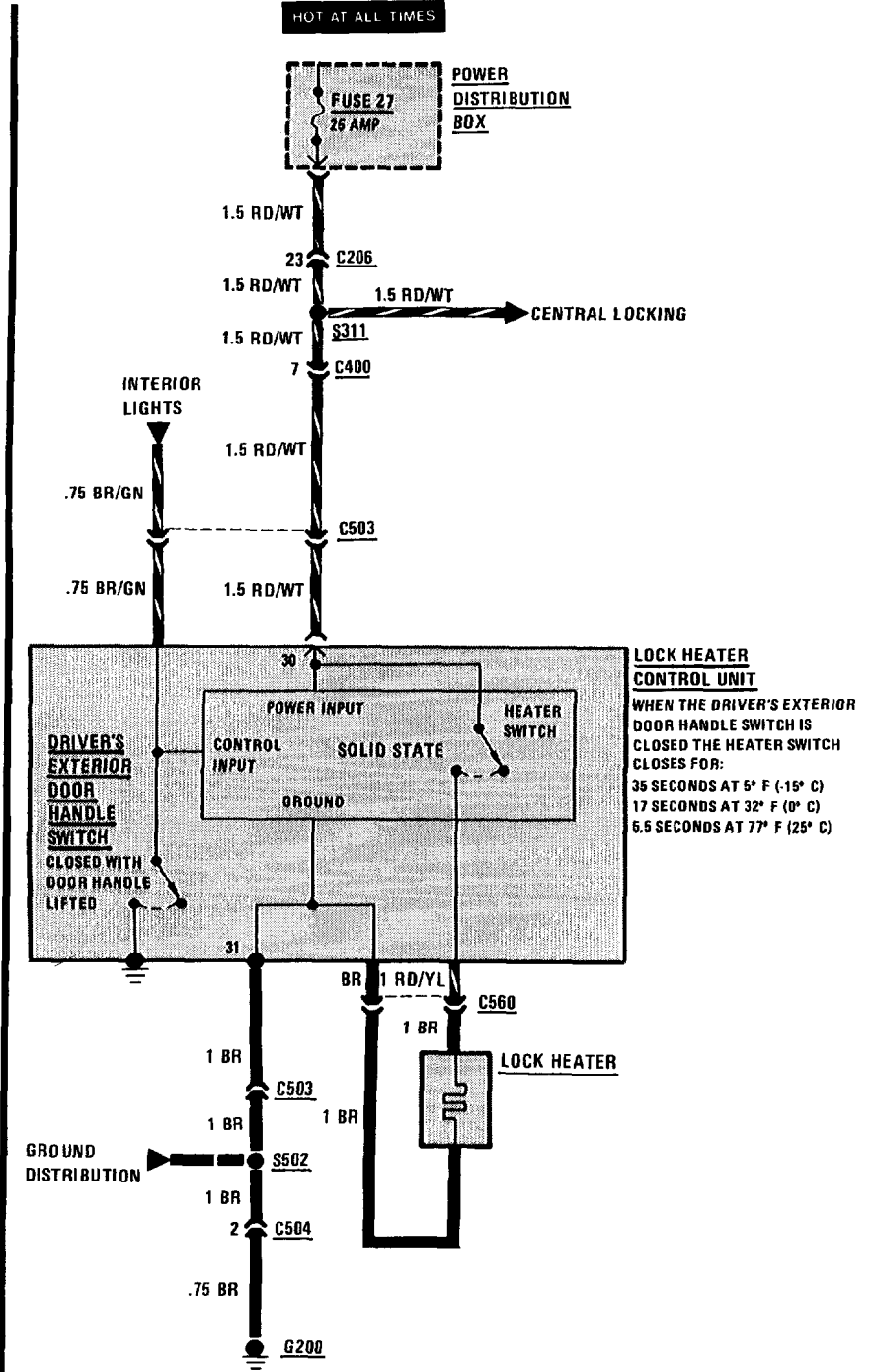



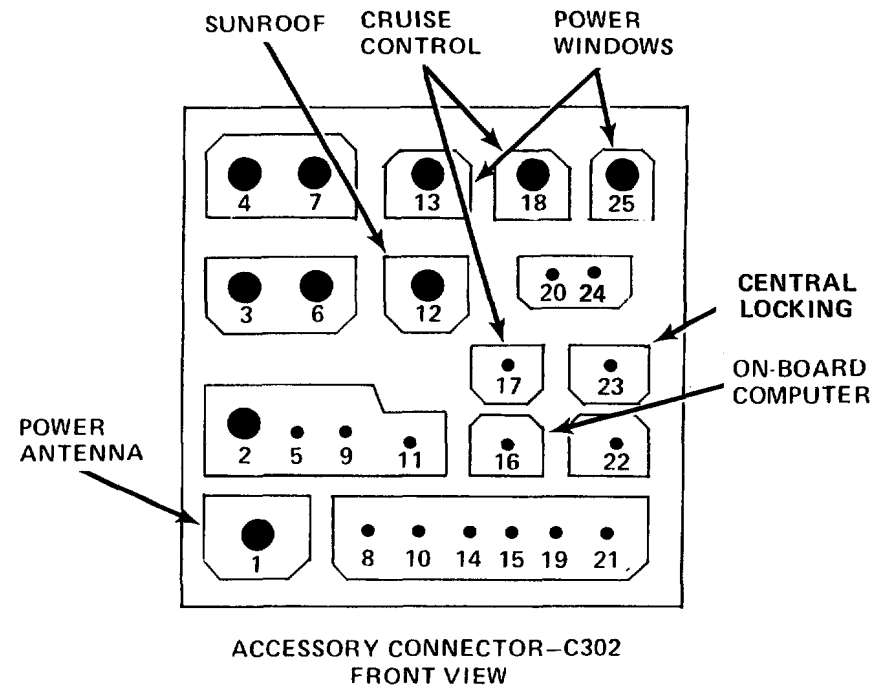
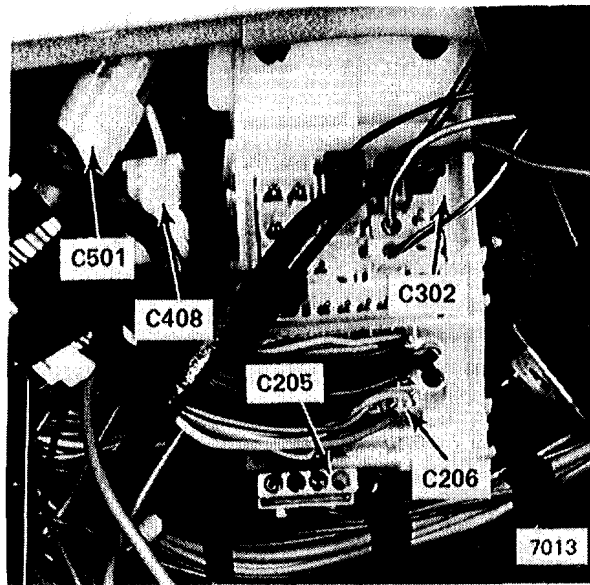
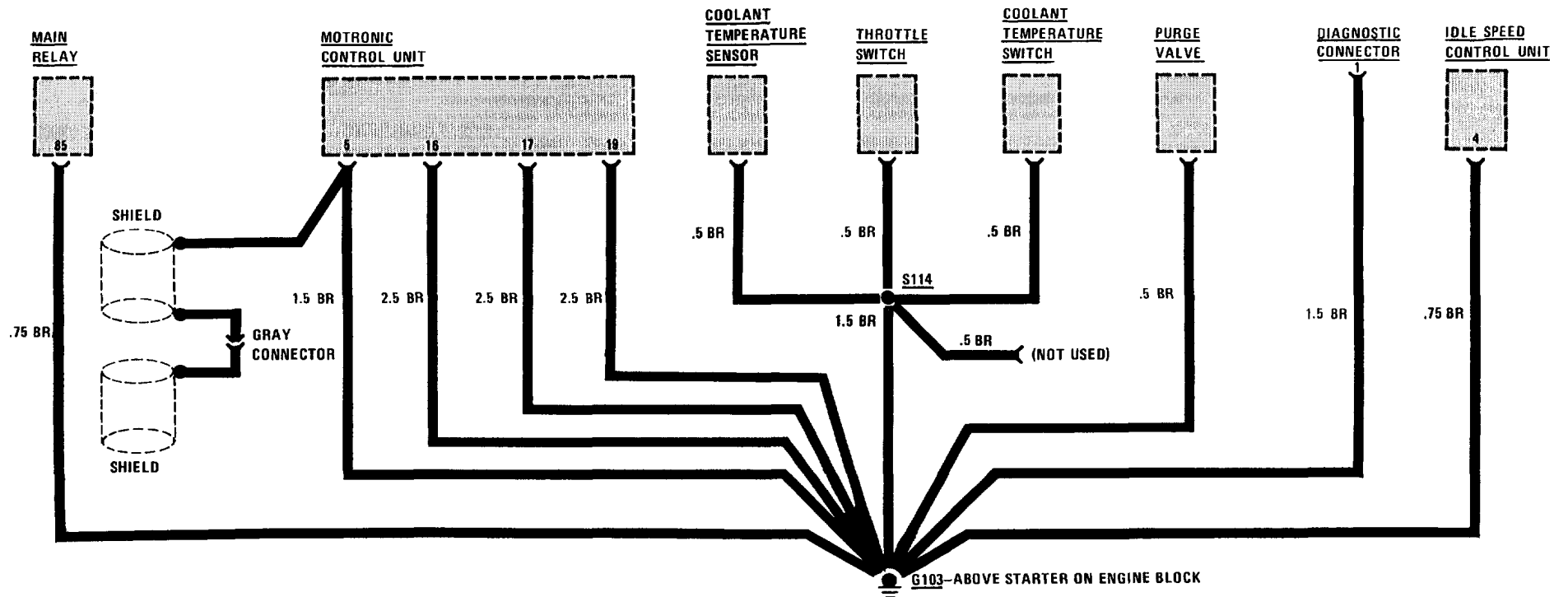
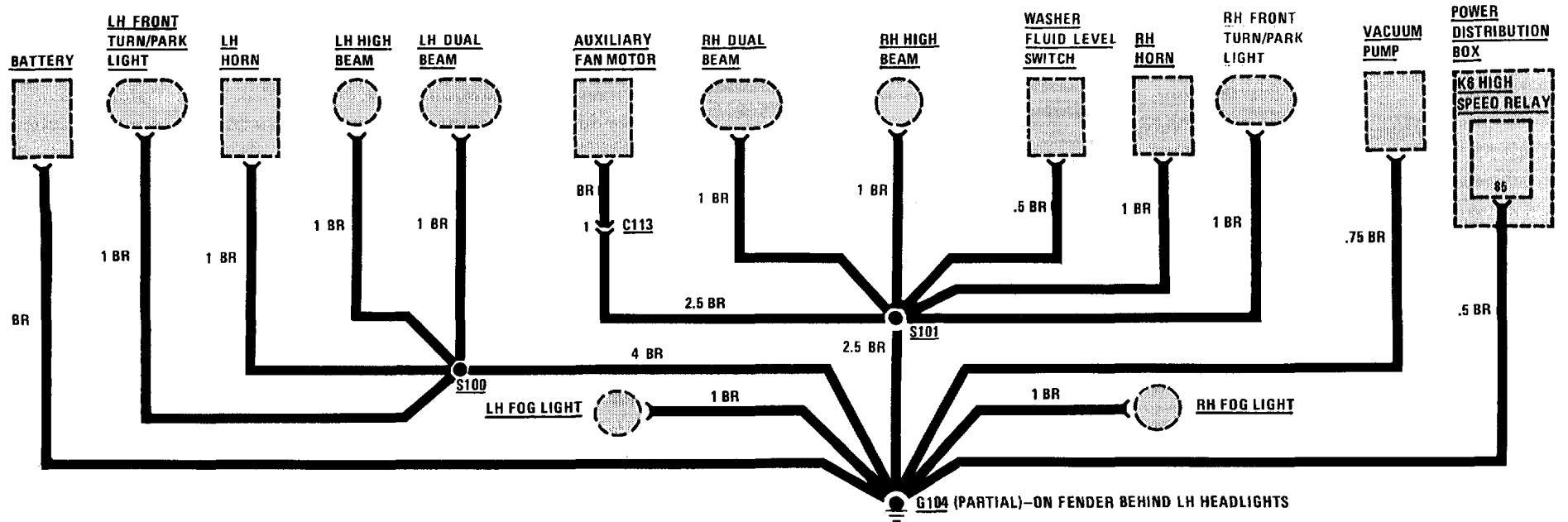
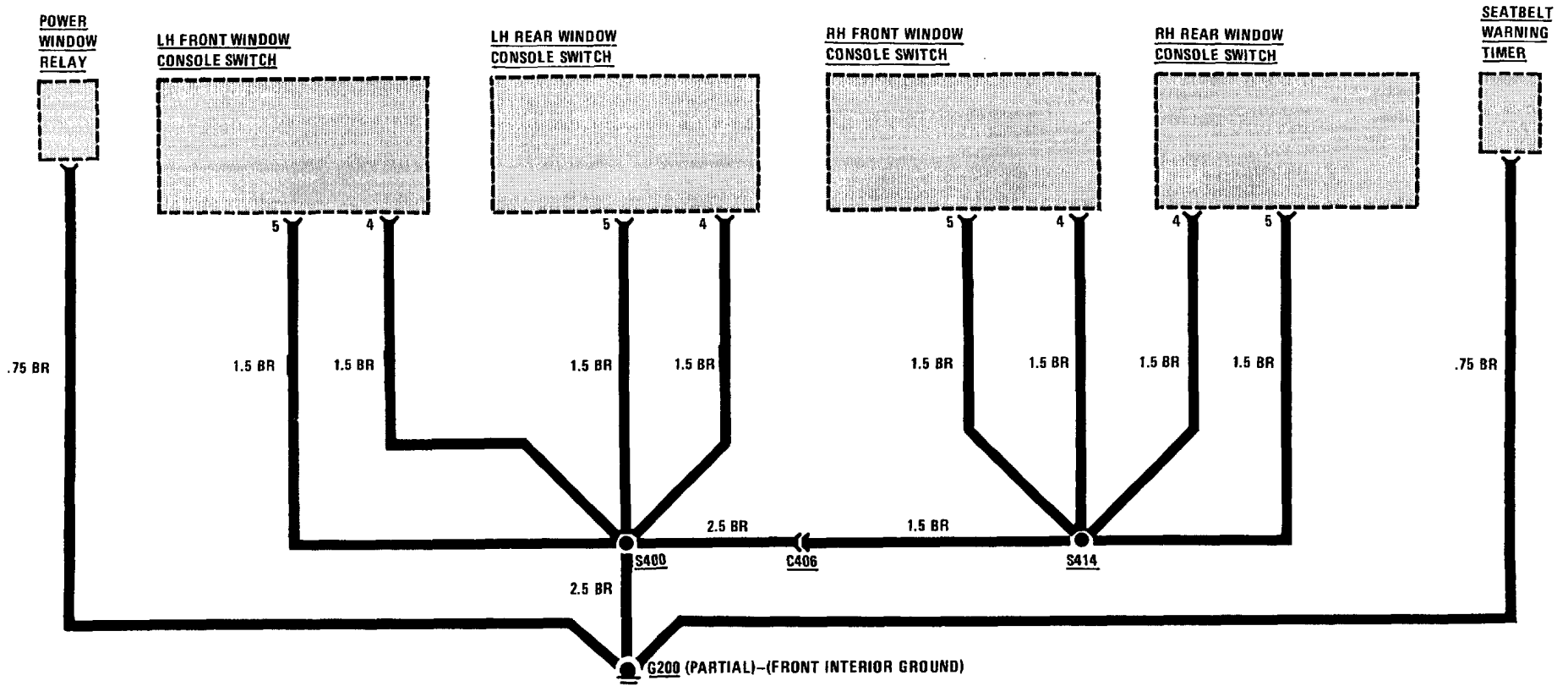
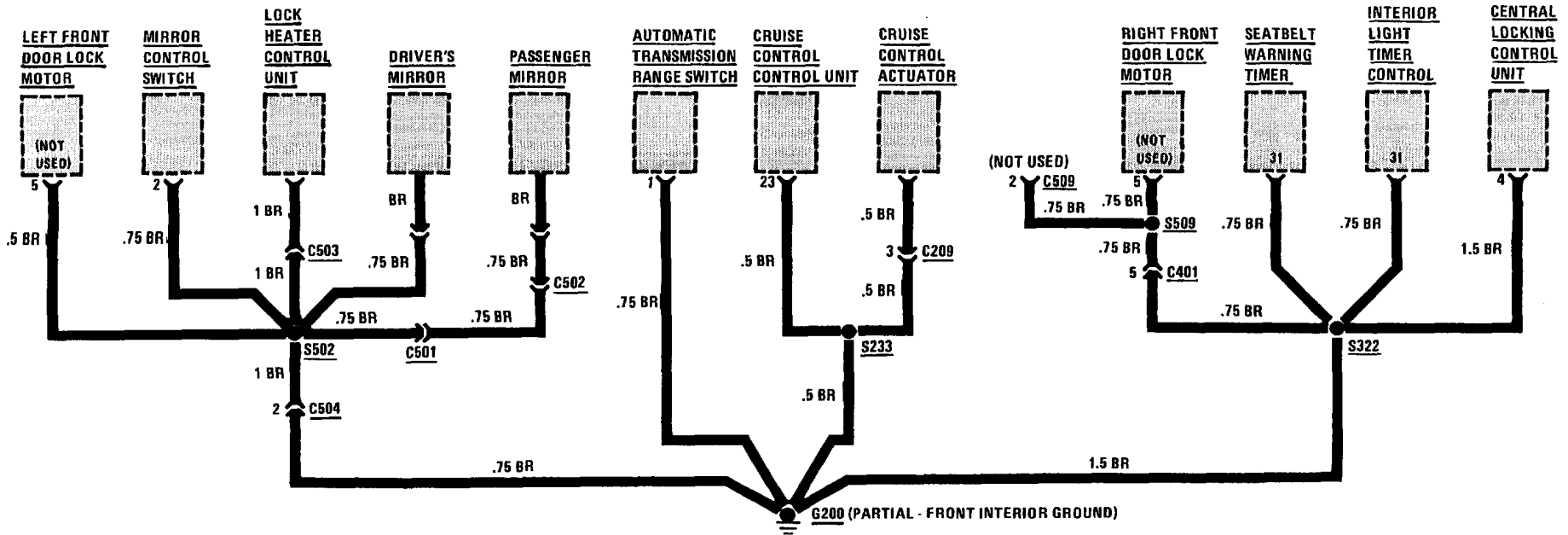
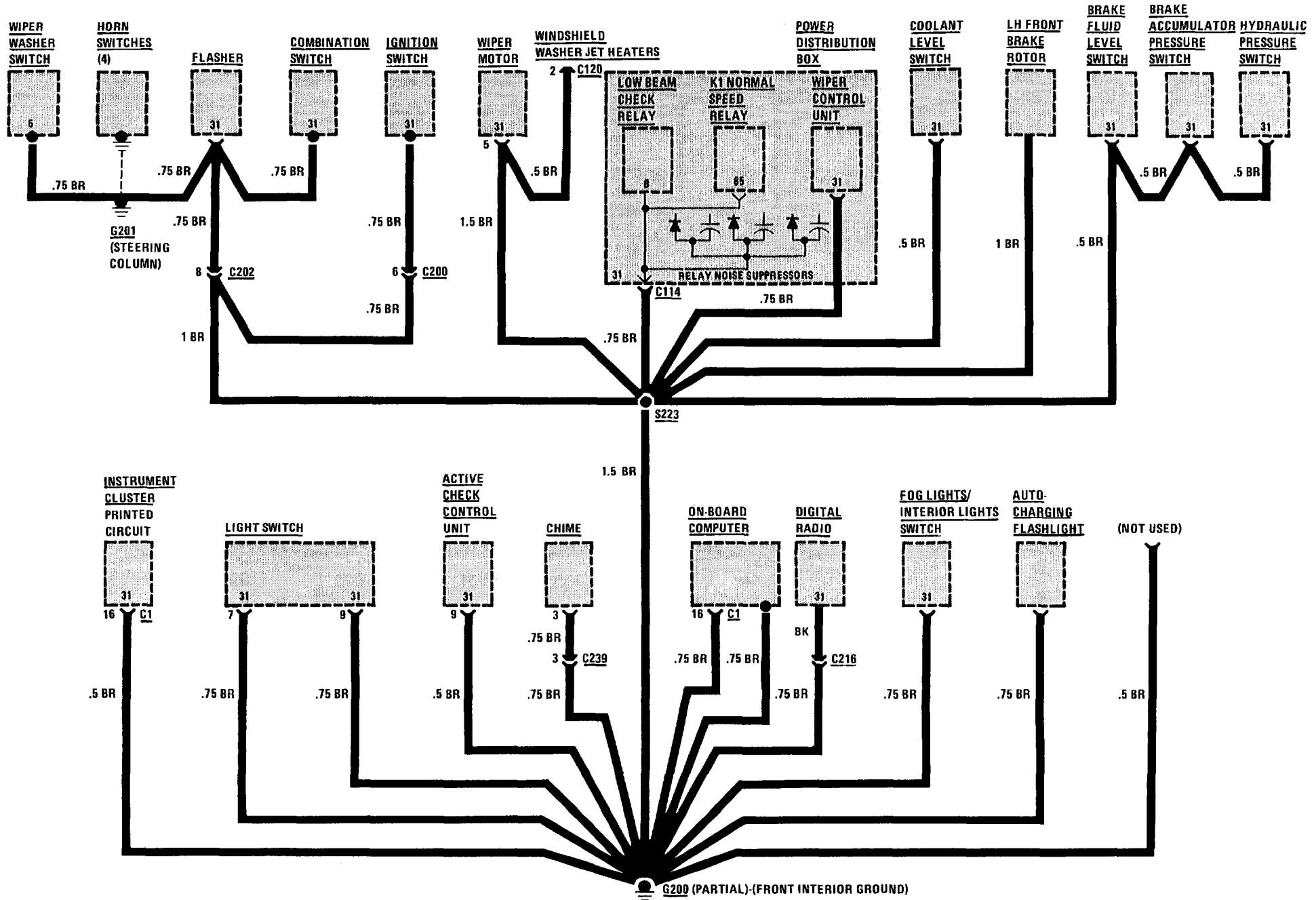

Figure 1 - Under Left Side Of Dash

# 156 GROUND DISTRIBUTION







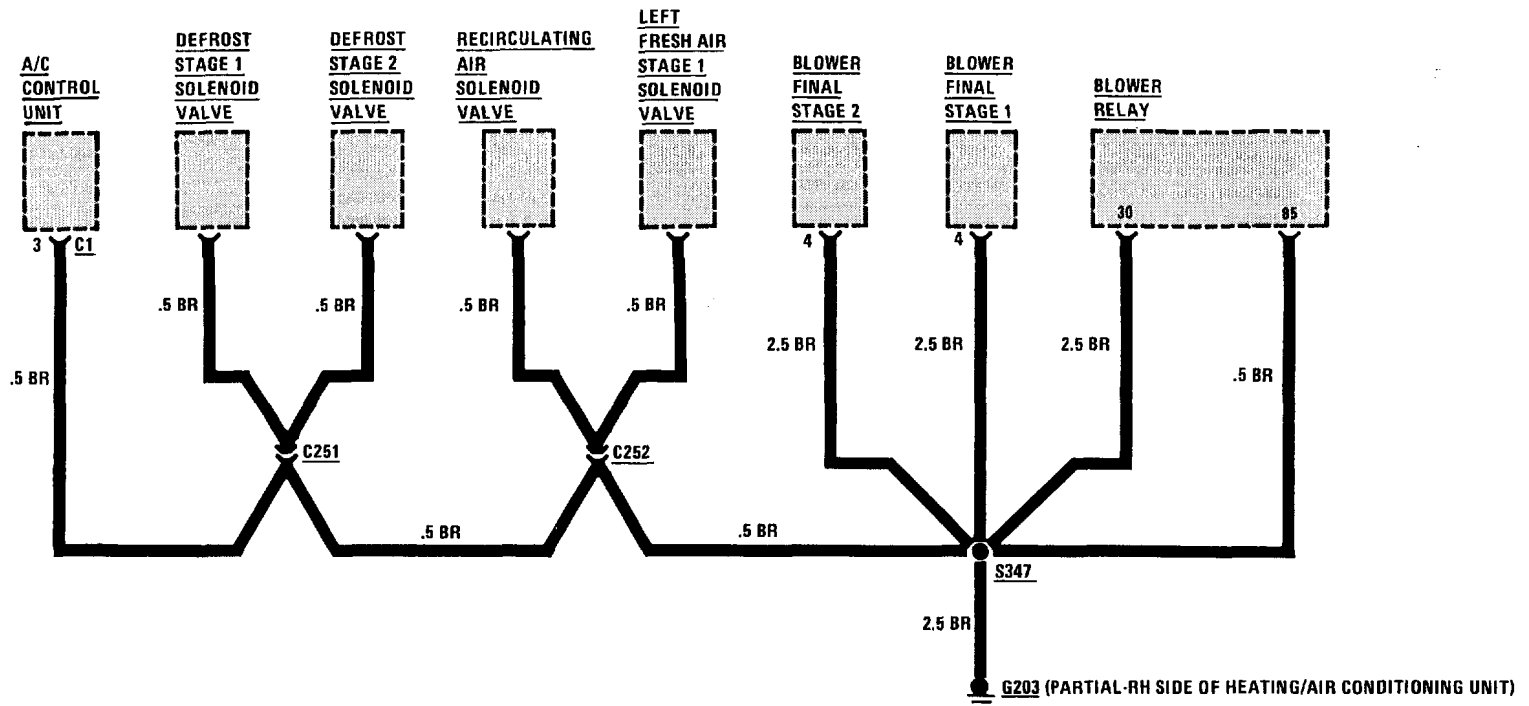
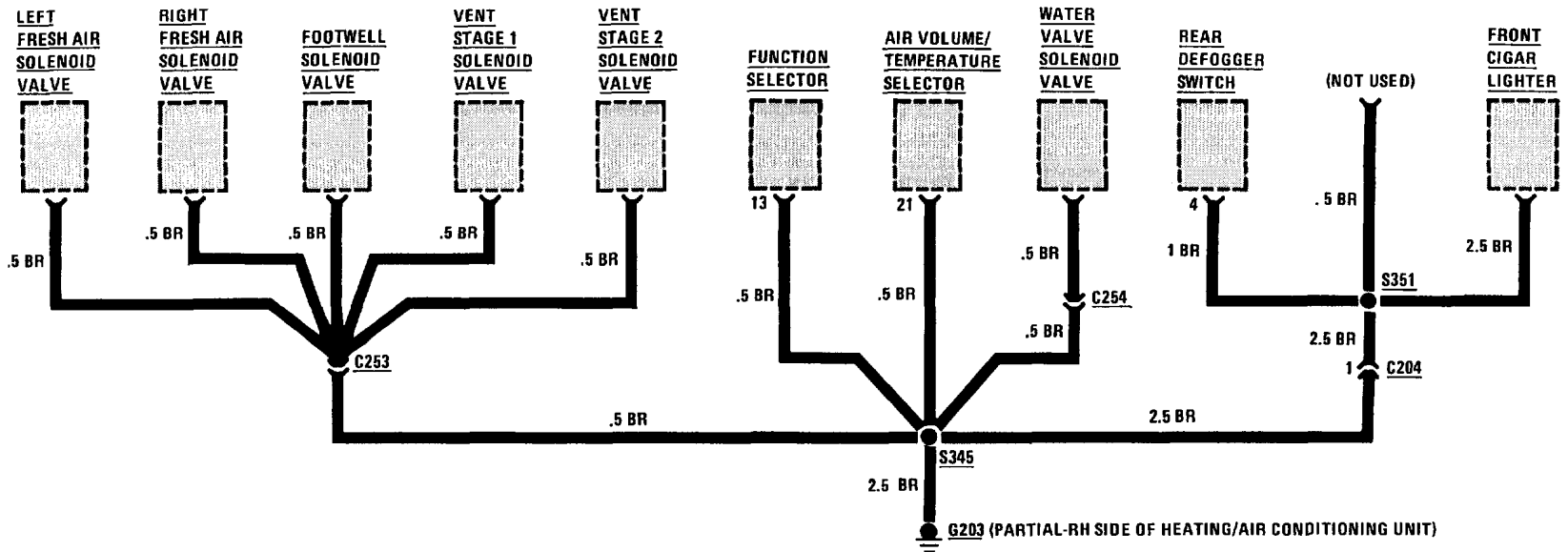

# 160 GROUND DISTRIBUTION

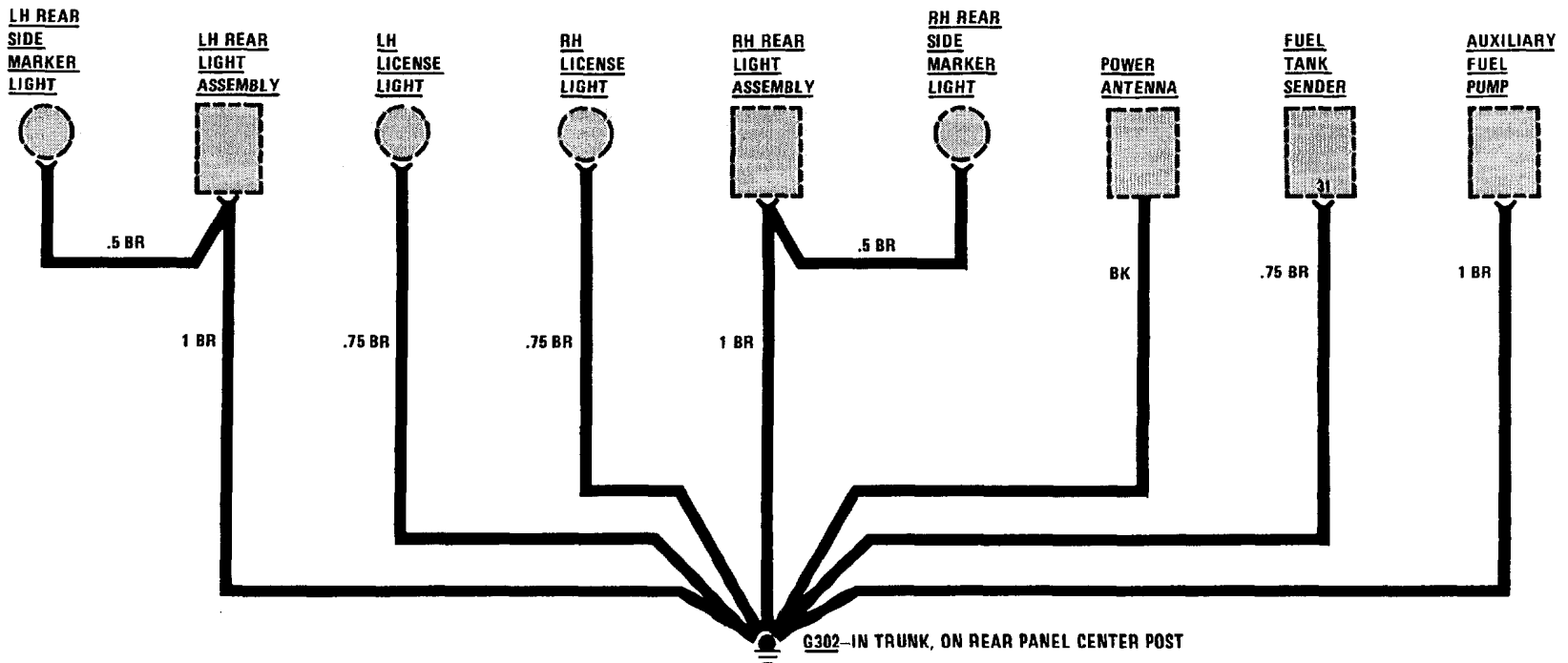
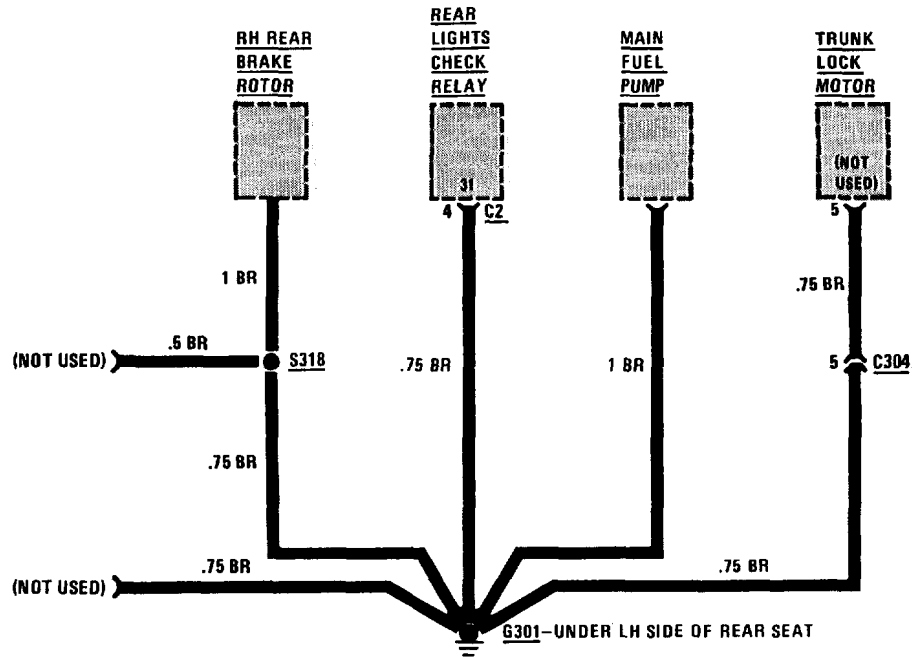

(For Component Locations See Page 215)

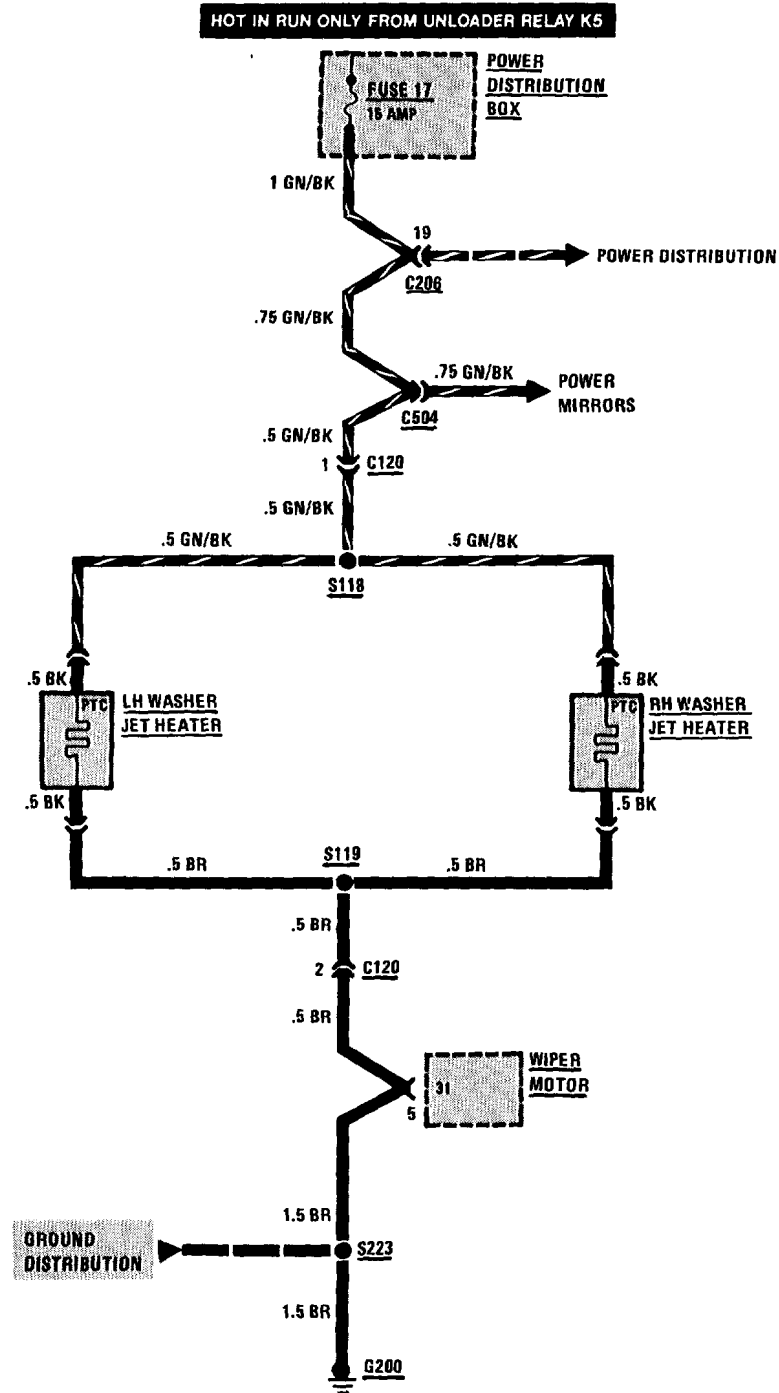

## ACTIVE CHECK CONTROL

Brake Switch .....	Above brake pedal	
Coolant Level Switch .....	Top left side of coolant reservoir .....	209-1
Oil Level Sensor .....	Bottom of engine oil pan	
Power Distribution Box .....	Top front of left front wheel well .....	102-1
Rear Lights Check Relay .....	Under left side of rear seat .....	207-2
Seatbelt Warning Timer .....	On right side of body electrical connector .....	210-1
Washer Fluid Level Switch ....	Ahead of right front wheel well, in reservoir	
C101 (17 pin) .....	On rear of power distribution box .....	203-2
C102 (13 pin) .....	In power distribution box	
C205 (4 pin) .....	Under LH dash, on body electrical bracket.....	207-1
C206 (29 pin) .....	Under LH dash, on body electrical bracket.....	207-1
G104 (Main Body Ground) ....	On power distribution box bracket .....	201-1
G200 (Front Interior Ground) ..	On dash frame, left of steering column.....	203-1
G301 (Rear Interior Ground) ..	Under left side of rear seat .....	207-2

## AUTOMATIC HEATER-AIR CONDITIONER

A/C Control Unit .....	Left side of evaporator housing.....	215-2
A/C In-Line Fuse .....	Below dash, right of console .....	202-1
Air Inlet Temp. Sensor.....	Under center of fresh air intake cowl .....	213-5
Blower Final Stage 1 .....	In right blower fan housing .....	204-1
Blower Final Stage 2 .....	In left blower fan housing.....	204-1
Blower Motor .....	Under center of fresh air intake cowl .....	201-2
Blower Relay .....	Under center of fresh air intake cowl .....	201-2
Compressor Relay .....	Under center of fresh air intake cowl .....	201-2
Coolant Temperature Sender/ Switch .....	Front of engine, on thermostat housing .....	211-2
Defrost Stage 1 Solenoid Valve	Left side of evaporator housing	
Defrost Stage 2 Solenoid Valve	Left side of evaporator housing	
Diagnostic Connector.....	Top middle of engine.....	101-1
Evaporator Temp. Switch.....	On support stand for blower motor	
Footwell Solenoid Valve .....	Behind center console	
High Pressure Cut-Out Switch ..	On receiver-dryer, below washer reservoir .....	209-2
In-Car Temp. Sen./Rear Pass. Area .....	Center of dash, in console .....	205-2
LH Fresh Air Stage 1 Sol. Valve	Behind center console	
LH Fresh Air Stage 2 Sol. Valve	Left side of evaporator housing	
Low Pressure Cutout Switch ..	On receiver-dryer, below washer reservoir .....	209-2
Power Distribution Box .....	Top front of left front wheel well .....	102-1
Rear Pass. Area Solenoid Valve	Behind center console	
Recirculating Air Solenoid Valve	Left side of evaporator housing	
RH Fresh Air Solenoid Valve ....	Behind center console	

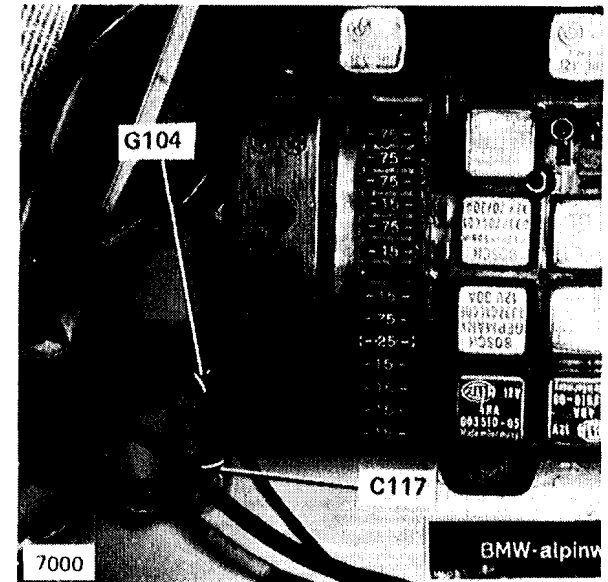

Figure 1 - Top Of Left Front Wheel Well

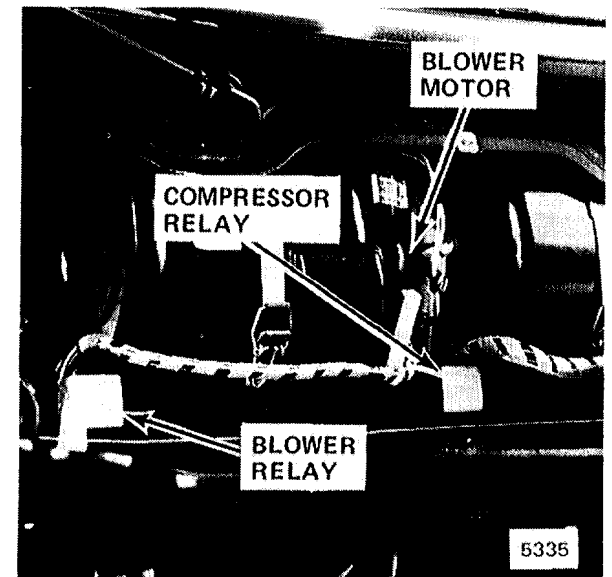

Figure 2 - Under Center Of Front Air Intake Cowl



## 202 COMPONENT LOCATIONS

(continued)

Vent Stage 1 Solenoid Valve ..	Behind center console	
Vent Stage 2 Solenoid Valve ..	Behind center console	
Water Valve Solenoid Valve ...	Right side of evaporator housing	
C101 (17 pin).....	On rear of power distribution box .....	203-2
C105 (2 pin) .....	Left of glove box hinge .....	202-1
C106 (1 pin) .....	On hose, above receiver-dryer .....	209-2
C204 (6 pin) .....	Behind center console .....	214-6
C221 (12 pin).....	Below dash, right of console .....	214-6
C243 (1 pin) .....	Behind center console	
C251 (1 pin) .....	Behind center console	
C252 (1 pin) .....	Behind center console	
C253 (1 pin) .....	Behind center console	
C254 (1 pin) .....	Behind center console	
G203 .....	On RH side of heater/air conditioning unit	

### AUXILIARY FAN/VACUUM PUMP

High Speed Temperature Switch	Lower right side of radiator (red terminals) .....	202-2
Normal Speed Blower Resistor	Ahead of radiator, on auxiliary fan shield	
Normal Speed Temperature Switch .....	Lower right side of radiator (white terminals) .....	202-2
Power Distribution Box .....	Top front of left front wheel well .....	102-1
Vacuum Pump .....	Right of left front shock tower	
C102 (13 pin).....	In power distribution box	
C113 (3 pin) .....	On auxiliary fan shield	
C116 (1 pin) .....	Near lower right side of radiator .....	155-1
C117 (1 pin) .....	Behind left hand side of battery .....	201-1
G104 (Main Body Ground)....	On power distribution box bracket .....	201-1
G200 (Front Interior Ground)	On dash frame, left of steering column.....	203-1

### BACKUP LIGHTS

Auto. Trans. Range Switch ....	On left side of shift lever	
Backup Light Switch.....	On left side of manual transmission	
Power Distribution Box .....	Top front of left front wheel well .....	102-1
C206 (29 pin).....	Under LH dash, on body electrical bracket.....	207-1
C301 (2 pin) .....	In center console, ahead of shift lever	
G302 (Trunk Ground).....	In trunk, on rear panel center support.....	208-1

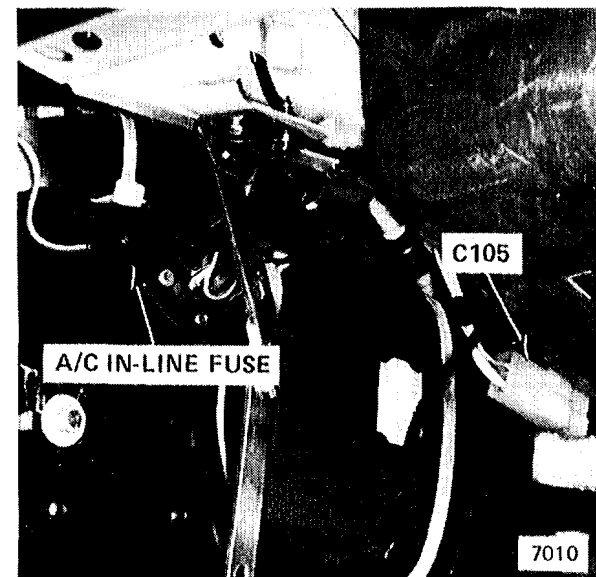

Figure 1 - Behind Dash, Left Of Glove Box

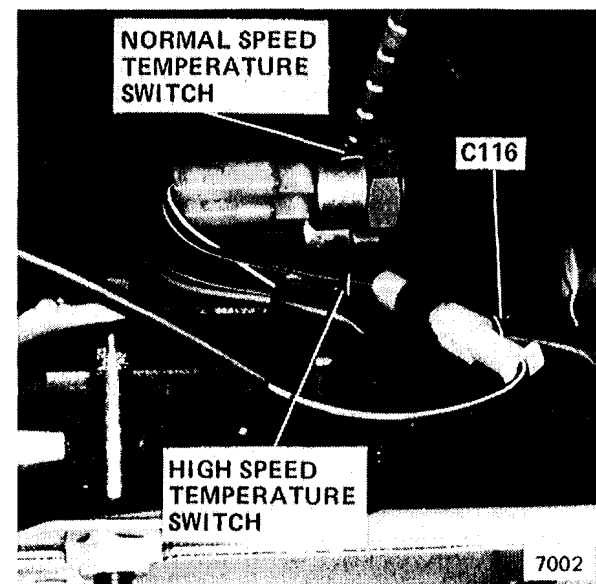

Figure 2 - Lower Right Side Of Radiator

## BRAKE LINING WARNING

Power Distribution Box .....	Top front of left front wheel well .....	102-1
C206 (29 pin) .....	Under LH dash, on body electrical bracket .....	207-1
G200 (Front Interior Ground) ..	On dash frame, left of steering column .....	203-1
G301 (Rear Interior Ground) ..	Under left side of rear seat .....	207-2

## CENTER CONSOLE LIGHTS

Power Distribution Box .....	Top front of left front wheel well .....	102-1
C204 (6 pin) .....	Behind center console .....	214-6
C221 (12 pin) .....	Below dash, right of console .....	214-6
G200 (Front Interior Ground) ..	On dash frame, left of steering column .....	203-1
G203 .....	On RH side of heater/air conditioning unit	

## CENTRAL LOCKING

Central Locking Control Unit ..	Under dash, above left front speaker grill .....	213-6
Door Lock Motors .....	In each door	
Gas Filler Lock Motor .....	In trunk, behind left rear wheel well .....	214-5
Ignition Switch .....	Upper part of steering column	
Power Distribution Box .....	Top front of left front wheel well .....	102-1
Trunk Lock Motor .....	In trunk lid, near trunk lock	
C200 (10 pin) .....	Under dash, on left side of steering column .....	203-1
C206 (29 pin) .....	Under LH dash, on body electrical bracket .....	207-1
C302 (Accessory Connector)	Under LH dash, on body electrical bracket .....	155-1
C304 (7 pin) .....	Ahead of left trunk hinge .....	210-2
C400 (7 pin) .....	Under LH dash, near body electrical bracket .....	215-1
C401 (7 pin) .....	Under right side of dash, right of glove box .....	214-2
C409 (3 pin) .....	In right center pillar	
C410 (3 pin) .....	In left center pillar	
C503 (8 pin) .....	In driver's door	
C504 (2 pin) .....	Under dash, above trunk release lever .....	213-6
C507 (3 pin) .....	In driver's door	
C508 (4 pin) .....	Under left hand dash	
G200 (Front Interior Ground) ...	On dash frame, left of steering column .....	203-1
G301 (Rear Interior Ground) ...	Under left side of rear seat .....	207-2



Figure 1 - Behind Dash, Left Of Steering Column

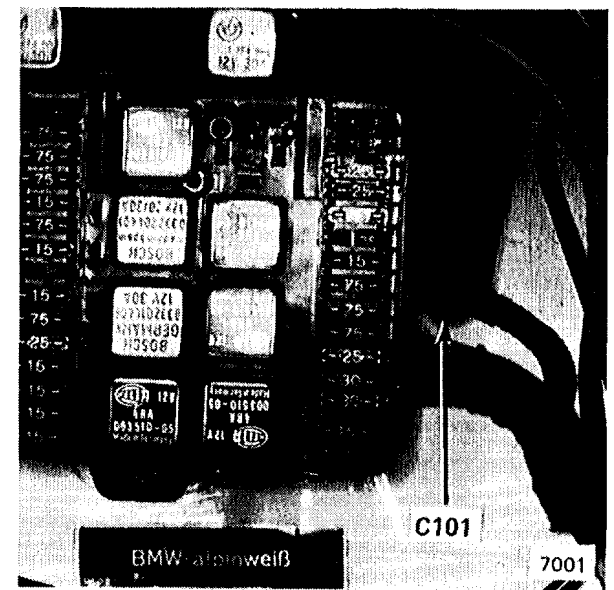

Figure 2 - Top Of Left Front Wheel Well

## CHARGING SYSTEM

Diagnostic Connector.....	Top middle of engine.....	101-1
Ignition Switch.....	Upper part of steering column	
Power Distribution Box .....	Top front of left front wheel well .....	102-1
Starter .....	Lower rear left side of engine	
C101 (17 pin).....	On rear of power distribution box .....	203-2
C200 (10 pin).....	Under dash, on left side of steering column .....	203-1
C206 (29 pin).....	Under LH dash, on body electrical bracket.....	207-1
C302 (Accessory Connector) ..	Under LH dash, on body electrical bracket.....	155-1
G104 (Main Body Ground)....	On power distribution box bracket .....	201-1

## CIGAR LIGHTER/GLOVE BOX LIGHT/ AUTO-CHARGING FLASHLIGHT

Glove Box Light Switch .....	Under right side of dash, above glove box	
Power Distribution Box .....	Top front of left front wheel well .....	102-1
C204 (6 pin) .....	Behind center console .....	214-6
C206 (29 pin) .....	Under LH dash, on body electrical bracket.....	207-1
C221(12 pin).....	Below dash, right of console .....	214-6
G200 (Front Interior Ground) ..	On dash frame, left of steering column.....	203-1
G202 .....	Center console	
G203 .....	On RH side of heater/air conditioning unit	

## FUEL CONTROL

Air Flow Meter.....	Top right side of engine .....	206-2
Main Relay .....	Behind right front shock tower .....	204-2
Motronic Control Unit .....	Behind right front speaker .....	211-1
Oxygen Sensor .....	Rear of engine, in exhaust manifold.....	204-2
G103 (Engine Ground).....	Top rear of engine .....	206-2

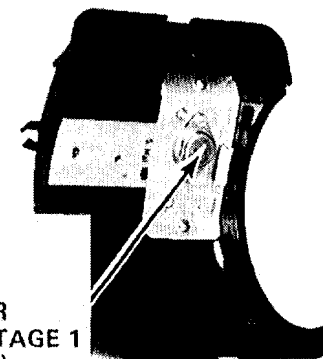

5327

Figure 1 - Removed Left Blower Fan Housing Cover

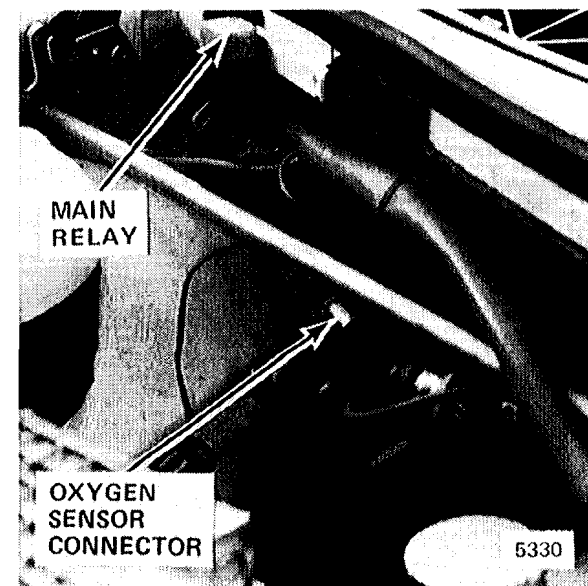

Figure 2 - Behind Right Front Shock Tower

## FUEL DELIVERY/EVAPORATOR CONTROL

Auxiliary Fuel Pump .....	Top left side of fuel tank, under trunk.....	214-4
Fuel Pump Relay .....	On right side of power distribution box .....	102-1
Ignition Switch.....	Upper part of steering column	
Main Fuel Pump .....	Under car, ahead of left rear axle	
Main Relay .....	Behind right front shock tower .....	204-2
Motronic Control Unit .....	Behind right front speaker .....	211-1
On-Board Computer .....	Behind left front speaker.....	208-2
Power Distribution Box .....	Top front of left front wheel well .....	102-1
Purge Valve .....	Right of power distribution box.....	205-1
Purge Valve Relay.....	On right side of power distribution box .....	102-1
C101 (17 pin).....	On rear of power distribution box .....	203-2
C103 (6 pin) .....	Behind right front speaker .....	211-1
C200 (10 pin).....	Under dash, on left side of steering column .....	203-1
C206 (29 pin).....	Under LH dash, on body electrical bracket.....	207-1
C212 (1 pin) .....	Under left side of dash, near steering column.....	215-1
C235 (1 pin) .....	Under left side of dash, near steering column.....	213-6
C236 (2 pin) .....	Under left side of dash, near steering column	
G103 (Engine Ground).....	Top rear of engine .....	206-2
G104 (Main Body Ground)....	On power distribution box bracket .....	201-1
G301 (Rear Interior Ground)...	Under left side of rear seat .....	207-2
G302 (Trunk Ground).....	In trunk, on rear panel center support.....	208-1

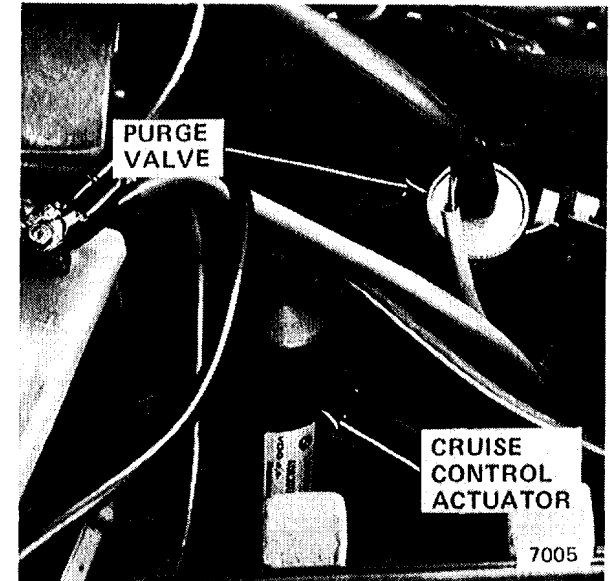

Figure 1 - Behind RH Side Of Battery

## HEADLIGHTS (CONTROL/POWER)/FOG LIGHTS (CONTROL/POWER)

Combination Switch .....	Upper left side of steering column .....	206-1
Flasher.....	Upper left side of steering column .....	206-1
Fog Lights/Interior Lights Switch	On dash, to right of steering column	
Ignition Switch.....	Upper part of steering column	
Power Distribution Box .....	Top front of left front wheel well .....	102-1
C102 (13 pin).....	In power distribution box	
C107 (2 pin) .....	Taped to harness, left of battery .....	213-3
C202 (13 pin).....	Under dash, on left side of steering column .....	210-1
C206 (29 pin).....	Under LH dash, on body electrical bracket.....	207-1
G104 (Main Body Ground)....	On power distribution box bracket .....	201-1
G200 (Front Interior Ground)..	On dash frame, left of steering column.....	203-1
G201 (Column Ground).....	Upper left side of steering column .....	206-1

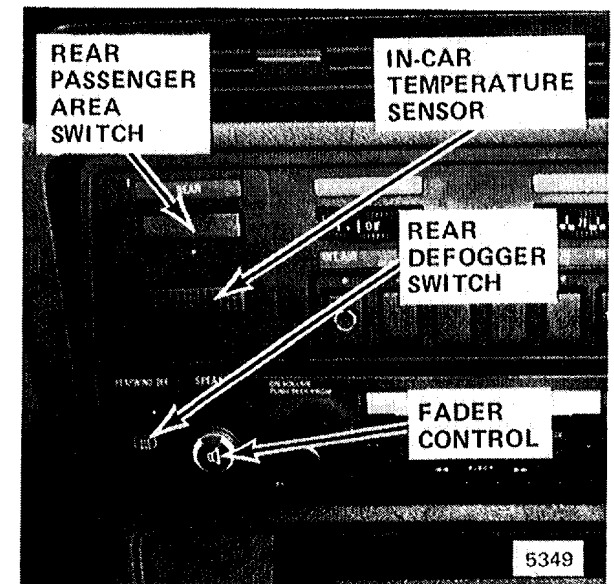

Figure 2 - Center Of Dash

## 206 COMPONENT LOCATIONS

### HORN/HEATED DOOR LOCK

Horn Brush/Slip Ring .....	Under hub of steering wheel	
Horn Switches .....	Under hub of steering wheel	
Lock Heater .....	In left front door .....	207-1
Lock Heater Control Unit .....	In left front door .....	207-1
Power Distribution Box .....	Top front of left front wheel well .....	102-1
C202 (13 pin) .....	Under dash, on left side of steering column .....	210-1
C206 (29 pin) .....	Under LH dash, on body electrical bracket .....	207-1
C400 (7 pin) .....	Under LH dash, near body electrical bracket .....	215-1
C503 (8 pin) .....	In driver's door	
C504 (2 pin) .....	Under dash, above trunk release lever .....	213-6
C560 (2 pin) .....	In driver's door	
G104 (Main Body Ground) ....	On power distribution box bracket .....	201-1
G200 (Front Interior Ground) ..	On dash frame, left of steering column .....	203-1
G201 (Column Ground) .....	Upper left side of steering column .....	206-1

### IDLE SPEED CONTROL

0°C (32°F) Temperature Switch .	On left inlet of blower motor housing .....	212-2
Auto. Trans. Range Switch ....	On left side of shift lever	
Coolant Temperature Sensor ...	Front of engine, top of thermostat housing .....	211-2
Coolant Temperature Switch ...	Front of engine, top of thermostat housing .....	211-2
Diagnostic Connector .....	Top middle of engine .....	101-1
Engine Speed Sensor .....	On transmission bell housing .....	206-2
Idle Control Valve .....	Top center of engine .....	213-2
Idle Speed Control Unit .....	Under right side of dash, above glove box	
Motronic Control Unit .....	Behind right front speaker .....	211-1
Power Distribution Box .....	Top front of left front wheel well .....	102-1
Throttle Switch .....	Top LH side of engine, below throttle body .....	213-2
C101 (17 pin) .....	On rear of power distribution box .....	203-2
C103 (6 pin) .....	Behind right front speaker .....	211-1
C104 (2 pin) .....	Behind right front speaker .....	211-1
C204 (6 pin) .....	Behind center console .....	214-6
C206 (29 pin) .....	Under LH dash, on body electrical bracket .....	207-1
C221 (12 pin) .....	Below dash, right of console .....	214-6
C301 (2 pin) .....	In center console, ahead of shift lever	
G103 (Engine Ground) .....	Top rear of engine .....	206-2

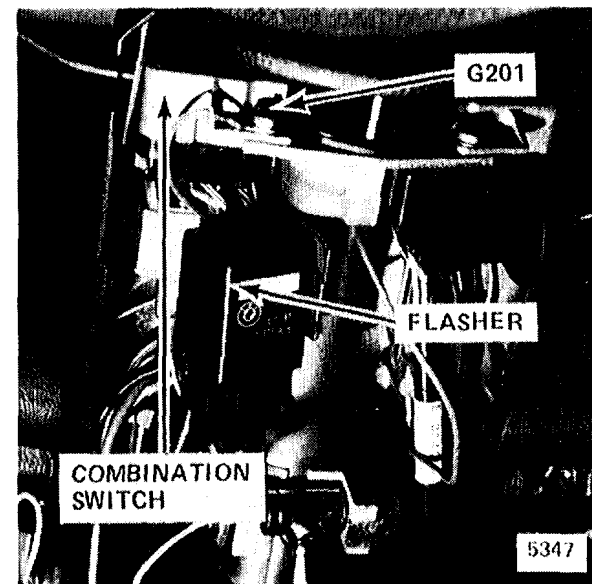

Figure 1 - Upper Underside Of Steering Column

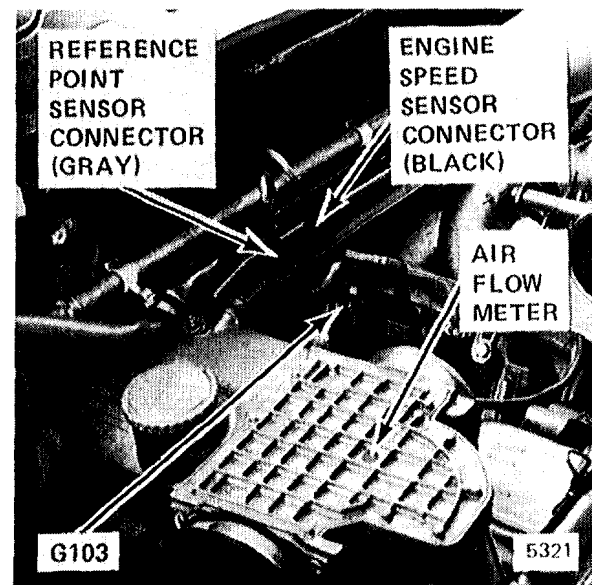

Figure 2 - Top Rear Of Engine

**IGNITION**

Diagnostic Connector.....	Top middle of engine.....	101-1
Ignition Coil .....	On right fender, behind headlights	
Ignition Switch.....	Upper part of steering column	
Motronic Control Unit .....	Behind right front speaker .....	211-1
Reference Point Sensor .....	On transmission bell housing.....	206-2
TDC Sensor .....	Above crankshaft vibration damper	
C101 (17 pin).....	On rear of power distribution box .....	203-2
C109 (1 pin) .....	Taped to harness, near ignition coil.....	
C200 (10 pin).....	Under dash, on left side of steering column .....	203-1
G103 (Engine Ground).....	Top rear of engine .....	206-2

**IGNITION KEY WARNING/SEATBELT WARNING**

Ignition Key Switch.....	In upper part of steering column	
Power Distribution Box .....	Top front of left front wheel well .....	102-1
Seatbelt Switch .....	In driver's seatbelt buckle	
Seatbelt Warning Timer .....	On right side of body electrical connector .....	210-1
Warning Buzzer .....	Upper left side of steering column .....	212-1
C200 (10 pin) .....	Under dash, on left side of steering column .....	203-1
C203 (2 pin) .....	Upper left side of steering column	
C205 (4 pin) .....	Under LH dash, on body electrical bracket.....	155-1
C206 (29 pin) .....	Under LH dash, on body electrical bracket.....	207-1
G200 (Front Interior Ground)	On dash frame, left of steering column.....	203-1

**INTERIOR LIGHTS**

Fog Lights/Interior Lights Switch	On dash, to right of steering column	
Interior Light Timer Control ...	On right side of body electrical connector .....	203-1
Lock Heater Control Unit .....	In left front door .....	207-1
Power Distribution Box .....	Top front of left front wheel well .....	102-1
C206 (29 pin) .....	Under LH dash, on body electrical bracket.....	207-1
C302 (Accessory Connector)	Under LH dash, on body electrical bracket.....	155-1
C303 (2 pin) .....	In headliner, above LH dome light .....	214-3
C503 (8 pin) .....	In driver's door	
C504 (2 pin) .....	Under dash, above trunk release lever.....	213-6
G200 (Front Interior Ground) ..	On dash frame, left of steering column.....	203-1

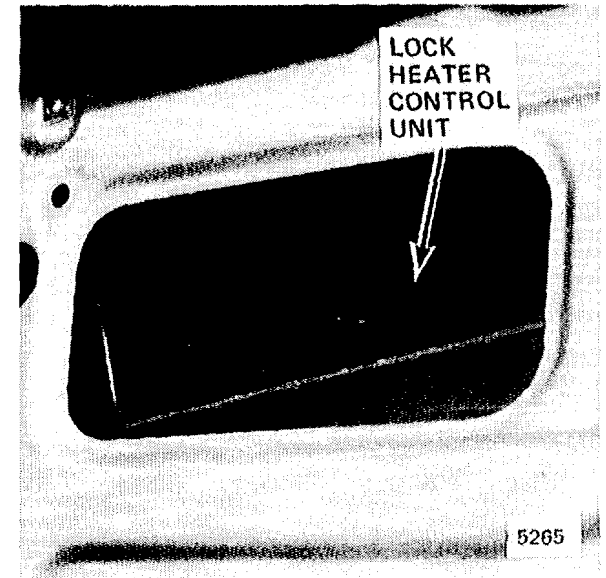

Figure 1 - Inside Driver's Door

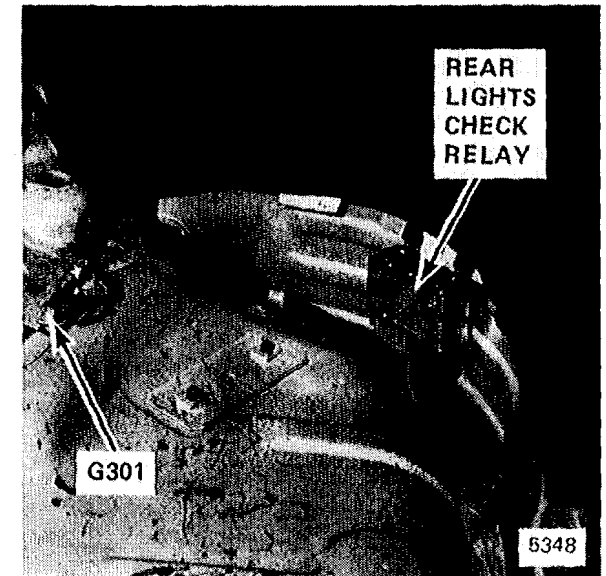

Figure 2 - Under Left Side Of Rear Seat

## 208 COMPONENT LOCATIONS

### LIGHTS: FRONT PARK/TAIL/UNDERHOOD

Power Distribution Box .....	Top front of left front wheel well .....	102-1
Rear Lights Check Relay .....	Under left side of rear seat .....	207-2
Underhood Light Switch .....	Under RH rear corner of hood, near latchplate	
C102 (13 pin) .....	In power distribution box	
C110 (1 pin) .....	Behind right headlights .....	213-1
C206 (29 pin) .....	Under LH dash, on body electrical bracket .....	207-1
G104 (Main Body Ground) ....	On power distribution box bracket .....	201-1
G301 (Rear Interior Ground)...	Under left side of rear seat .....	207-2
G302 (Trunk Ground).....	In trunk, on rear panel center support.....	208-1

### LIGHTS: REAR MARKER/LICENSE/TRUNK

Auto. Trans. Range Switch ....	On left side of shift lever	
Fog Lights/Interior Lights Switch	On dash, to right of steering column	
On-Board Computer .....	Behind left front speaker .....	208-2
Power Distribution Box .....	Top front of left front wheel well .....	102-1
C206 (29 pin) .....	Under LH dash, on body electrical bracket .....	207-1
C255 (1 pin) .....	Under right side of dash, right of glove box .....	214-2
C301 (2 pin) .....	In center console, ahead of shift lever	
G200 (Front Interior Ground)..	On dash frame, left of steering column.....	203-1
G202 .....	Center console	
G306 .....	Top of right A pillar	

### LIGHTS: RH VISOR/DASH/TRANSMISSION RANGE

Power Distribution Box .....	Top front of left front wheel well .....	102-1
Rear Lights Check Relay .....	Under left side of rear seat .....	207-2
Trunk Light Switch .....	In trunk lid, near trunk lock	
C206 (29 pin) .....	Under LH dash, on body electrical bracket .....	207-1
C300 (1 pin) .....	Ahead of left trunk hinge .....	210-2
C302 (Accessory Connector) ..	Under LH dash, on body electrical bracket .....	155-1
C304 (7 pin) .....	Ahead of left trunk hinge .....	210-2
G301 (Rear Interior Ground) ....	Under left side of rear seat .....	207-2
G302 (Trunk Ground) .....	In trunk, on rear panel center support.....	208-1

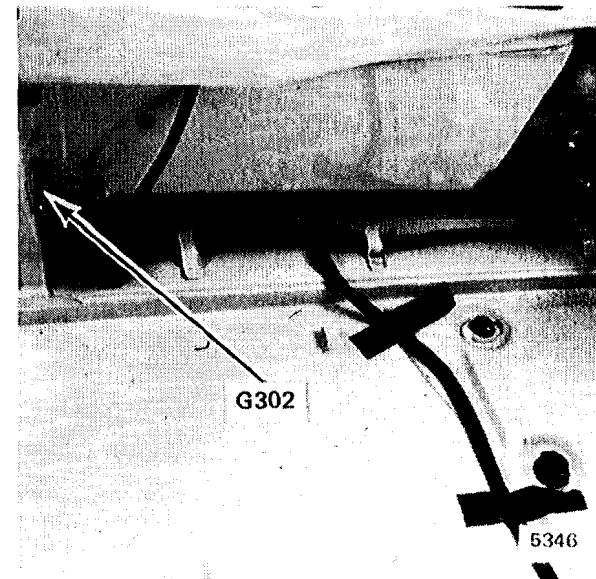

Figure 1 - Left Rear Left Side Of Trunk

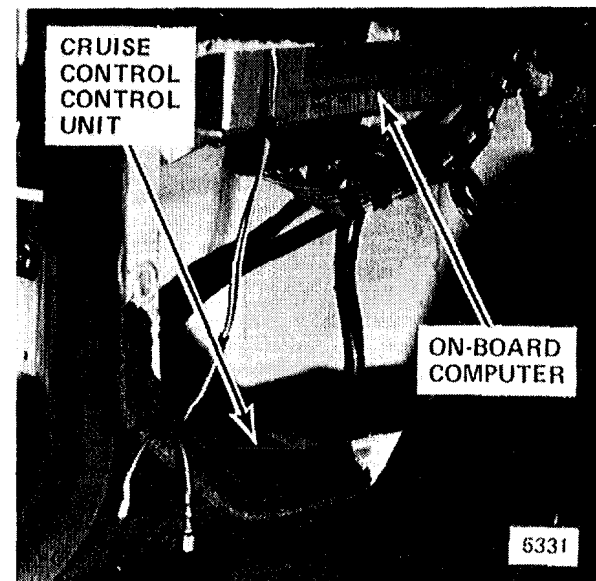

Figure 2 - Behind Left Front Speaker

## LIGHTS: TURN/HAZARD WARNING

Combination Switch .....	Upper left side of steering column .....	206-1
Flasher .....	Upper left side of steering column .....	206-1
Ignition Switch .....	Upper part of steering column	
Power Distribution Box .....	Top front of left front wheel well .....	102-1
C102 (13 pin) .....	In power distribution box	
C200 (10 pin) .....	Under dash, on left side of steering column .....	203-1
C202 (13 pin) .....	Under dash, on left side of steering column .....	210-1
C206 (29 pin) .....	Under LH dash, on body electrical bracket .....	207-1
G104 (Main Body Ground) ....	On power distribution box bracket .....	201-1
G200 (Front Interior Ground) ..	On dash frame, left of steering column .....	203-1
G201 (Column Ground) .....	Upper left side of steering column .....	206-1
G302 (Trunk Ground) .....	In trunk, on rear panel center support .....	208-1

## ON-BOARD COMPUTER

Alarm Horn .....	Ahead of RH side of coolant reservoir .....	213-4
Chime .....	Top center of dash, under grill	
Filter Capacitor .....	Ahead of coolant reservoir .....	213-4
Ignition Switch .....	Upper part of steering column	
Main Relay .....	Behind right front shock tower .....	204-2
On-Board Computer .....	Behind left front speaker .....	208-2
Outside Temperature Sensor ...	Under front bumper, left side	
Power Distribution Box .....	Top front of left front wheel well .....	102-1
C103 (6 pin) .....	Behind right front speaker .....	211-1
C200 (10 pin) .....	Under dash, on left side of steering column .....	203-1
C206 (29 pin) .....	Under LH dash, on body electrical bracket .....	207-1
C212 (1 pin) .....	Under left side of dash, near steering column .....	215-1
C235 (1 pin) .....	Under left side of dash, near steering column .....	213-6
C236 (2 pin) .....	Under left side of dash, near steering column .....	
C237 (3 pin) .....	Behind brake fluid reservoir .....	209-1
C239 (4 pin) .....	Behind instrument cluster	
C240 (1 pin) .....	Behind instrument cluster	
C242 (2 pin) .....	Above left front speaker grill	
C302 (Accessory Connector) ..	Under LH dash, on body electrical bracket .....	155-1
G103 (Engine Ground) .....	Top rear of engine .....	206-2
G104 (Main Body Ground) ....	On power distribution box bracket .....	201-1
G200 (Front Interior Ground) ..	On dash frame, left of steering column .....	203-1

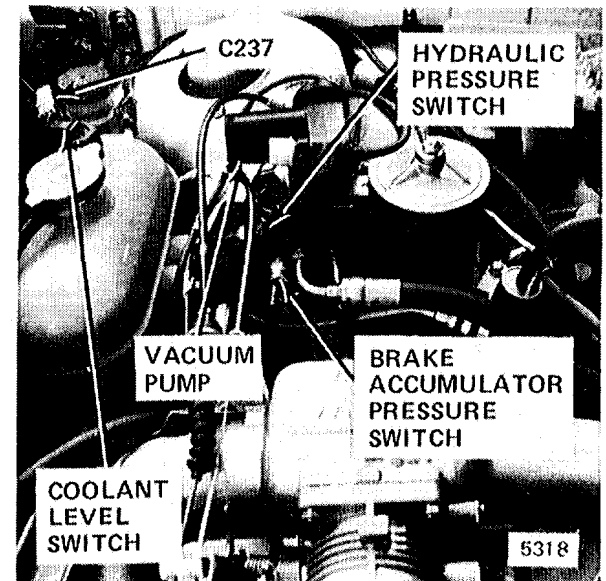

Figure 1 - Left Rear Of Engine Compartment

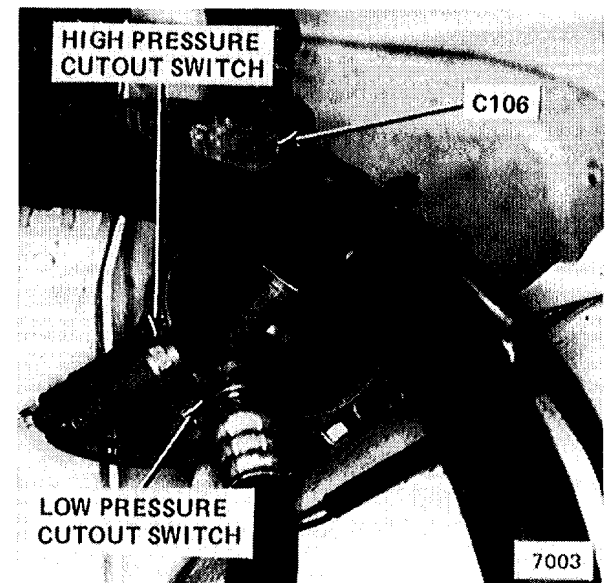

Figure 2 - Behind Right Headlights



## 210 COMPONENT LOCATIONS

### POWER DISTRIBUTION

Diagnostic Connector.....	Top middle of engine.....	101-1
Ignition Switch.....	Upper part of steering column.	
Power Distribution Box .....	Top front of left front wheel well .....	102-1
Starter .....	Lower rear left side of engine	
C200 (10 pin).....	Under dash, on left side of steering column .....	203-1
C206 (29 pin).....	Under LH dash, on body electrical bracket.....	207-1
C221 (12 pin).....	Below dash, right of console .....	214-6
C302 (Accessory Connector) ..	Under LH dash, on body electrical bracket.....	155-1
G104 (Main Body Ground) ....	On power distribution box bracket .....	201-1
G200 (Front Interior Ground) ..	On dash frame, left of steering column.....	203-1

### POWER MIRRORS

Power Distribution Box .....	Top front of left front wheel well .....	102-1
C206 (29 pin).....	Under LH dash, on body electrical bracket.....	207-1
C501 (5 pin) .....	Under dash, left of steering column.....	155-1
C502 (5 pin) .....	Under right side of dash, right of glove box.....	214-2
C504 (2 pin) .....	Under dash, above trunk release lever.....	213-6
G200 (Front Interior Ground) ..	On dash frame, left of steering column.....	203-1

### POWER WINDOWS

Power Distribution Box .....	Top front of left front wheel well .....	102-1
Power Window Circuit Breaker	On LH under dash cover.....	210-1
Power Window Relay .....	Under LH dash, above trunk release lever .....	215-1
Window Motors.....	In each door	
C206 (29 pin).....	Under LH dash, on body electrical bracket.....	207-1
C302 (Accessory Connector) ..	Under LH dash, on body electrical bracket.....	155-1
C402 (2 pin) .....	In left center pillar	
C403 (2 pin) .....	In right center pillar	
C404 (1 pin) .....	In left center pillar	
C405 (1 pin) .....	In right center pillar	
C406 (3 pin) .....	Behind center console	
C407 (2 pin) .....	Under right side of dash, right of glove box. ....	214-2
C408 (2 pin) .....	To left of body electrical bracket .....	155-1
G200 (Front Interior Ground) ..	On dash frame, left of steering column.....	203-1

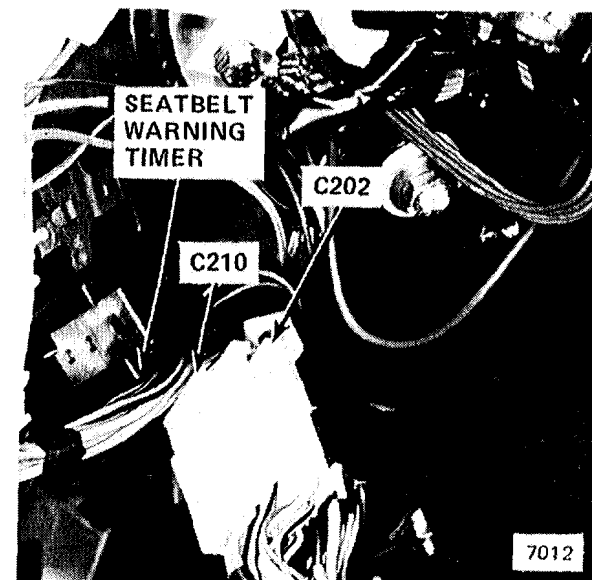

Figure 1 - Behind Dash, Left Of Steering Column

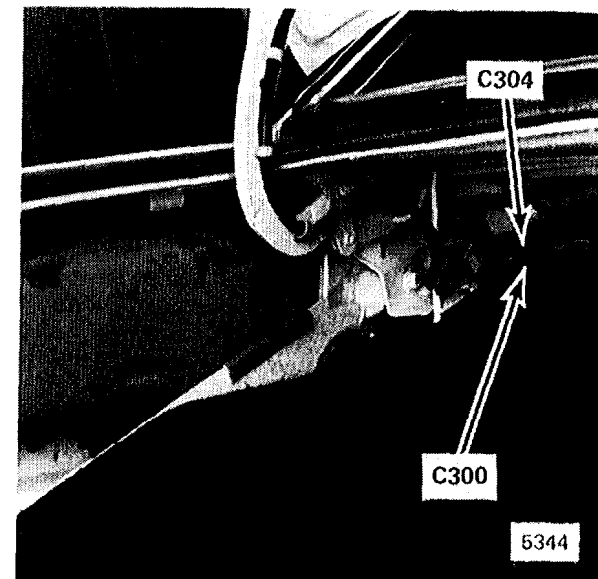

Figure 2 - Left Trunk Hinge

**RADIO/POWER ANTENNA**

Power Distribution Box .....	Top front of left front wheel well .....	102-1
C206 (29 pin) .....	Under LH dash, on body electrical bracket .....	207-1
C215 (2 pin) .....	Behind radio	
C216 (2 pin) .....	Behind radio	
C217 (2 pin) .....	Behind radio	
C218 (2 pin) .....	Behind radio	
C302 (Accessory Connector) ...	Under LH dash, on body electrical bracket .....	155-1
G200 (Front Interior Ground) ...	On dash frame, left of steering column .....	203-1

**REAR DEFOGGER/SUNROOF**

Power Distribution Box .....	Top front of left front wheel well .....	102-1
Sunroof Drive Motor .....	Above headliner, above rear view mirror	
Sunroof Limit Switch .....	Above headliner, above rear view mirror	
Sunroof Motor Relay .....	Above headliner, above rear view mirror	
C204 (6 pin) .....	Behind center console .....	214-6
C206 (29 pin) .....	Under LH dash, on body electrical bracket .....	207-1
C221 (12 pin) .....	Below dash, right of console .....	214-6
C302 (Accessory Connector) ...	Under LH dash, on body electrical bracket .....	155-1
G203 .....	On RH side of heater/air conditioning unit	
G305 .....	In RH C pillar	
G600 .....	Above headliner, above rear view mirror	

**SERVICE INTERVAL INDICATOR**

Coolant Temperature Sender/ Switch .....	Front of engine, on thermostat housing .....	211-2
Diagnostic Connector .....	Top middle of engine .....	101-1
Motronic Control Unit .....	Behind right front speaker .....	211-1
Power Distribution Box .....	Top front of left front wheel well .....	102-1
C101 (17 pin) .....	On rear of power distribution box .....	203-2
C103 (6 pin) .....	Behind right front speaker .....	211-1
G200 (Front Interior Ground) ...	On dash frame, left of steering column .....	203-1

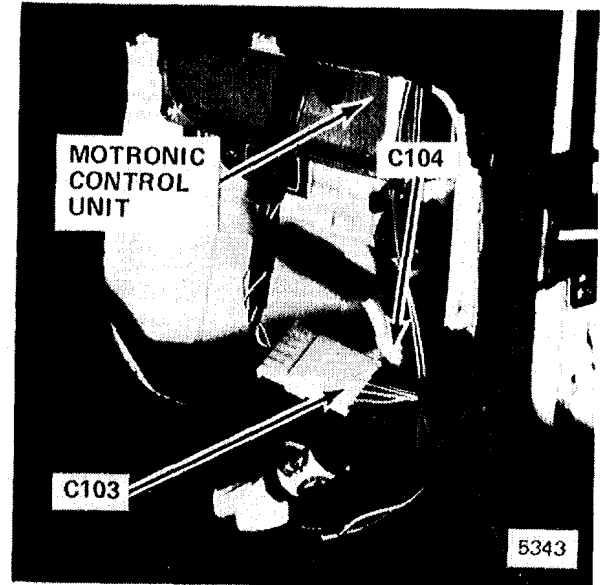

Figure 1 - Behind Right Front Speaker

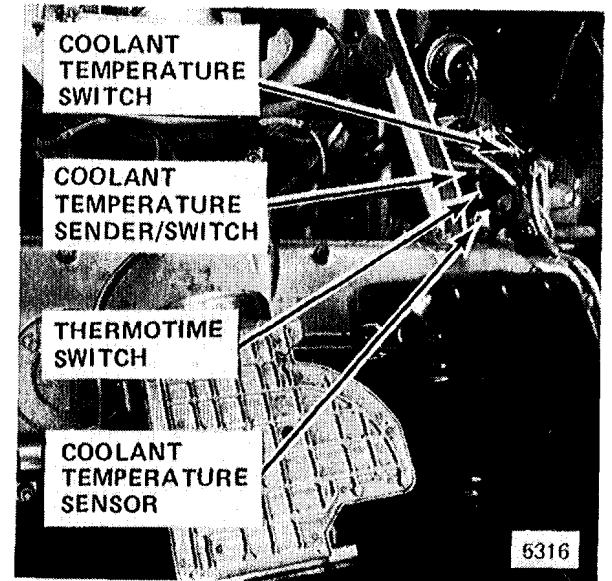

Figure 2 - Top Front Of Engine

## SPEEDOMETER/GAUGES/WARNING INDICATORS

Brake Accum. Pres. Switch . . . .	Right of left front shock tower . . . . .	209-1
Brake Fluid Level Switch . . . . .	To left of engine, on brake fluid reservoir	
Coolant Temperature Sender/ Switch . . . . .	Front of engine, on thermostat housing . . . . .	211-2
Diagnostic Connector . . . . .	Top middle of engine . . . . .	101-1
Fuel Tank Sender . . . . .	Top left side of fuel tank, under trunk . . . . .	214-4
Hydraulic Pressure Switch . . . . .	Right of left front shock tower . . . . .	209-1
Ignition Switch . . . . .	Upper part of steering column	
Motronic Control Unit . . . . .	Behind right front speaker . . . . .	211-1
Oil Pressure Switch . . . . .	Left rear end of cylinder head	
Parking Brake Switch . . . . .	In shift console, at base of parking brake	
Power Distribution Box . . . . .	Top front of left front wheel well . . . . .	102-1
Speedometer Sender . . . . .	In rear of differential	
C101 (17 pin) . . . . .	On rear of power distribution box . . . . .	203-2
C103 (6 pin) . . . . .	Behind right front speaker . . . . .	211-1
C200 (10 pin) . . . . .	Under dash, on left side of steering column . . . . .	203-1
C202 (13 pin) . . . . .	Under dash, on left side of steering column . . . . .	210-1
G200 (Front Interior Ground) . . . . .	On dash frame, left of steering column . . . . .	203-1
G302 (Trunk Ground) . . . . .	In trunk, on rear panel center support . . . . .	208-1

## START

Auto. Trans. Range Switch . . . .	On left side of shift lever	
Cold Start Valve . . . . .	Between intake ports 3 and 4	
Diagnostic Connector . . . . .	Top middle of engine . . . . .	101-1
Ignition Switch . . . . .	Upper part of steering column	
Power Distribution Box . . . . .	Top front of left front wheel well . . . . .	102-1
Start Relay . . . . .	Under LH dash, on body electrical bracket	
Starter . . . . .	Lower rear left side of engine	
Thermo Time Switch . . . . .	Front of engine, top of thermostat housing . . . . .	211-2
C101 (17 pin) . . . . .	On rear of power distribution box . . . . .	203-2
C200 (10 pin) . . . . .	Under dash, on left side of steering column . . . . .	203-1
G104 (Main Body Ground) . . . . .	On power distribution box bracket . . . . .	201-1
G200 (Front Interior Ground) . . . . .	On dash frame, left of steering column . . . . .	203-1

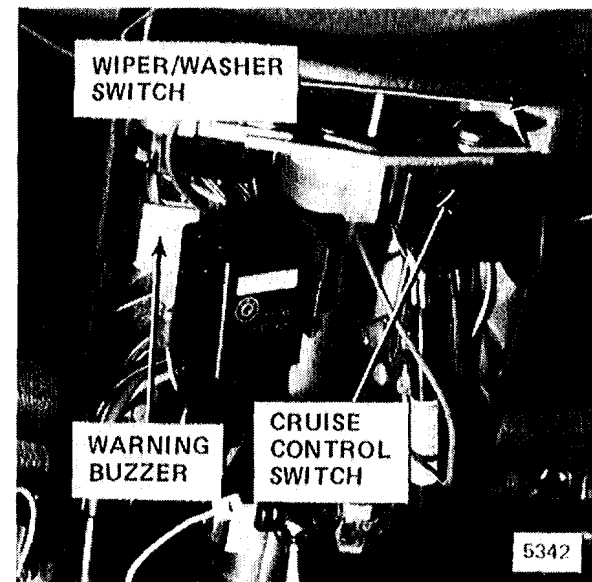

Figure 1 - Upper Underside Of Steering Column

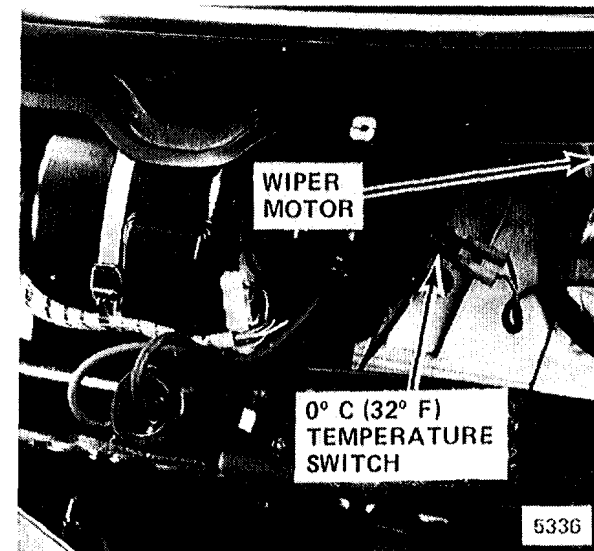

Figure 2 - Under Center Of Fresh Air Intake Cowl

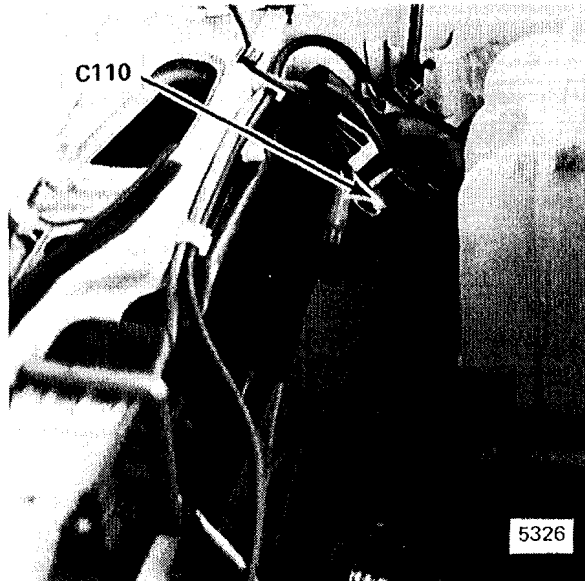

Figure 1 - Behind Right Headlights

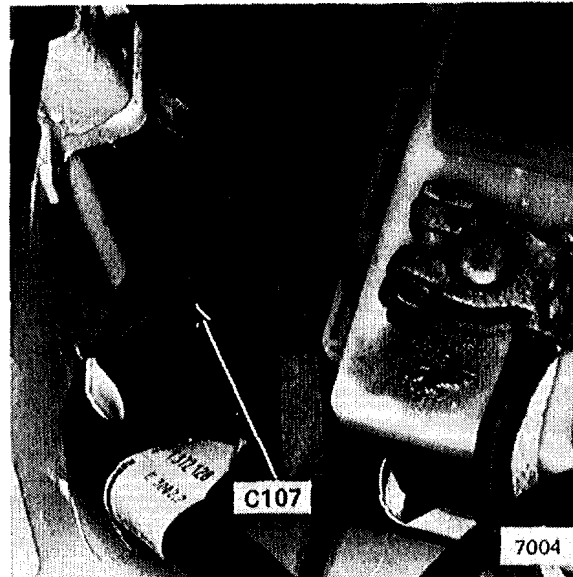

Figure 3 - Left Of Battery



Figure 5 - Under Center Of Fresh Air Intake Cowl

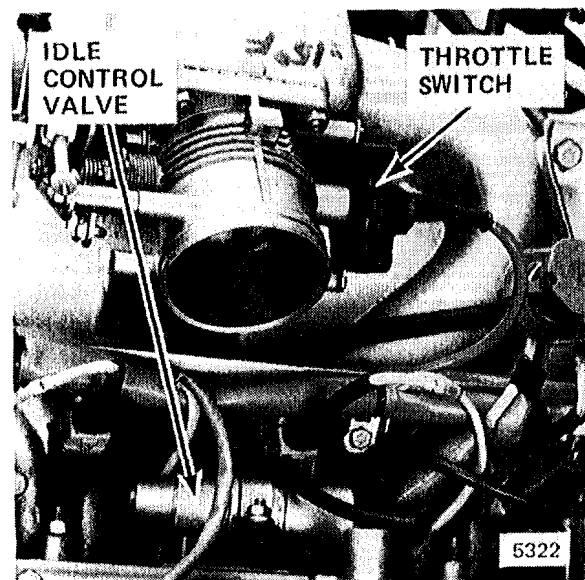

Figure 2 - Top Center Of Engine

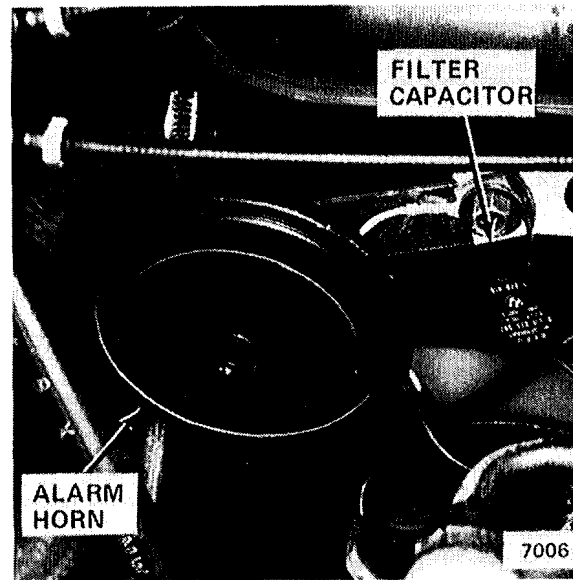

Figure 4 - Ahead Of Coolant Reservoir

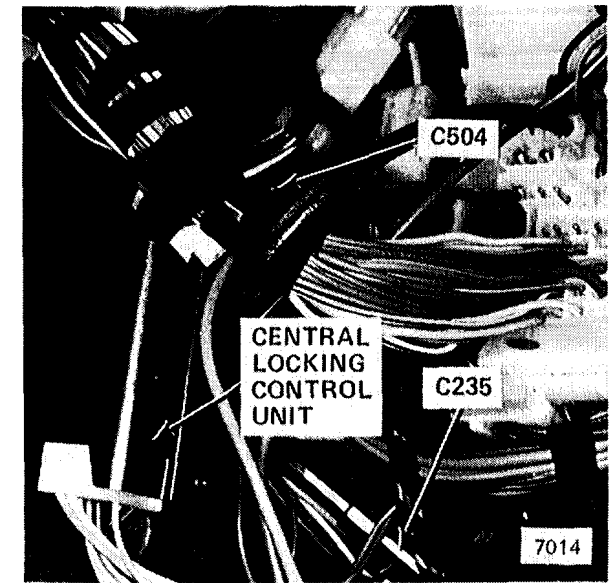

Figure 6 - Behind Dash, Above Left Front Speaker

## 214 COMPONENT LOCATIONS



Figure 1- Center Of Dash

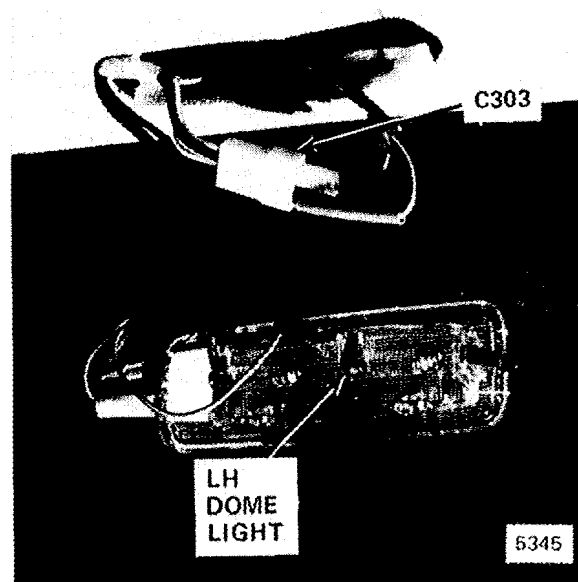

Figure 3 - Header, Above Left B Pillar

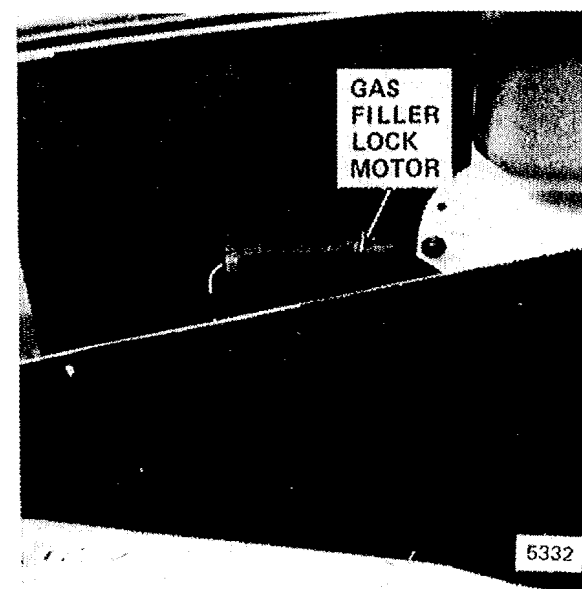

Figure 5 - Behind Left Rear Wheel Well

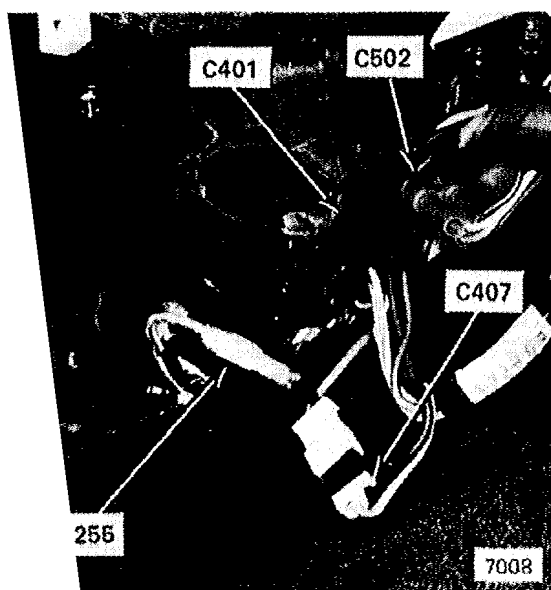

Figure 2 - Behind Dash, Right Of Glove Box

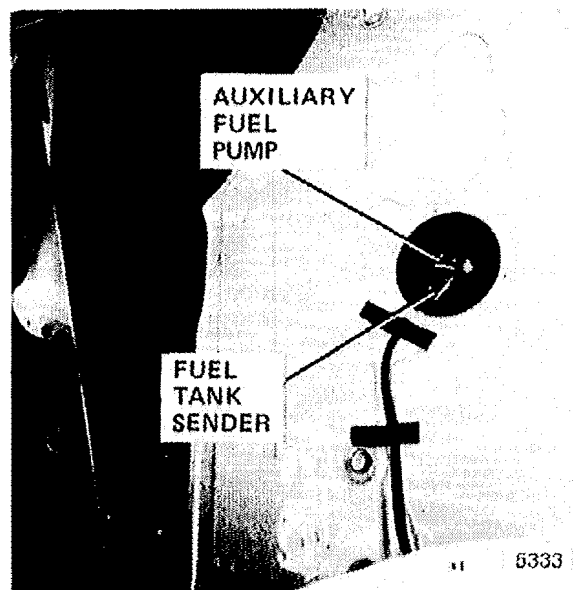

Figure 4 - Bottom Left Side Of Trunk

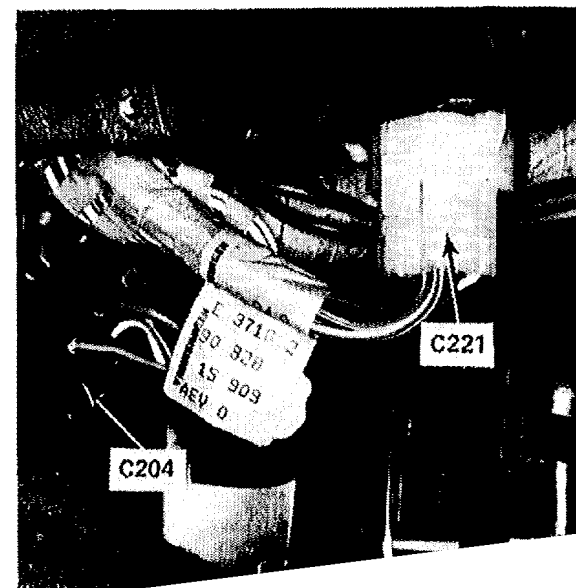

Figure 6 - Electrical Components

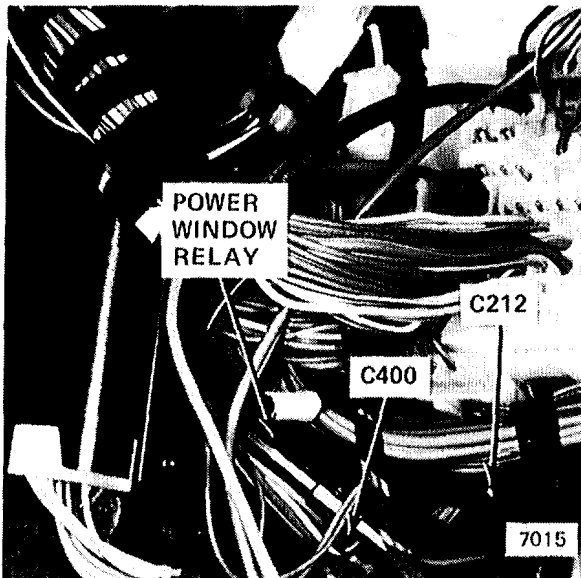

Figure 1 - Behind Dash Above Left Front Speaker



Figure 2 - Behind Left Side Of Console

## STOPLIGHTS/CRUISE CONTROL

Auto. Trans. Range Switch	....	On left side of shift lever	
Brake Switch	.....	Above brake pedal	
Clutch Switch	.....	Above clutch pedal	
Cruise Control Actuator	.....	Right of power distribution box	205-1
Cruise Control Control Unit	...	Behind left front speaker	208-2
Power Distribution Box	.....	Top front of left front wheel well	102-1
Rear Lights Check Relay	.....	Under left side of rear seat	207-2
C206 (29 pin)	.....	Under LH dash, on body electrical bracket	207-1
C208 (2 pin)	.....	Above accelerator pedal	
C209 (7 pin)	.....	Under dash, above left front speaker	
C210 (4 pin)	.....	Under dash, on left side of steering column	210-1
C301 (2 pin)	.....	In center console, ahead of shift lever	
C302 (Accessory Connector)	..	Under LH dash, on body electrical bracket	155-1
G200 (Front Interior Ground)	..	On dash frame, left of steering column	203-1
G301 (Rear Interior Ground)	..	Under left side of rear seat	207-2
G302 (Trunk Ground)	.....	In trunk, on rear panel center support	208-1

## WINDSHIELD WASHER

Power Distribution Box	.....	Top front of left front wheel well	102-1
Washer Jet Heaters	.....	On washer jet nozzles	
Wiper Motor	.....	Under left side fresh air intake cowl	212-2
C120 (2 pin)	.....	Near wiper motor	
C206 (29 pin)	.....	Under LH dash, on body electrical bracket	207-1
C504 (2 pin)	.....	Under dash, above trunk release lever	213-6
G200 (Front Interior Ground)	..	On dash frame, left of steering column	203-1

## WIPER/WASHER

Power Distribution Box	.....	Top front of left front wheel well	102-1
Washer Pump	.....	Ahead of right front wheel well, in reservoir	
Wiper Motor	.....	Under left side fresh air intake cowl	212-2
C102 (13 pin)	.....	In power distribution box	
C201 (6 pin)	.....	Under dash, on left side of steering column	203-1
G200 (Front Interior Ground)	..	On dash frame, left of steering column	203-1
G201 (Column Ground)	.....	Upper left side of steering column	206-1