

1989
 BMW 735i/735iL/750iL (E32)
 Electrical
 Troubleshooting
 Manual
 Vehicles Produced 9/88—5/89

CONTENTS

Index	0100-00
Introduction	0110-00
Systematic Troubleshooting	0130-00
Symbols	0140-00
Power Distribution Chart	0660-00
Fuse Chart	0661-00
Power Distribution	0670-00
Fuse Details	0671-00
Ground Distribution	0672-00
Component Location Chart	7000-00
Component Location Views	7100-00
Splice Location Views	8000-00
Connector Views	8500-00



INDEX

Antilock Brake System (ABS)	3450-00
Antitheft System (DWA)	6575-00
Automatic Rear Headrest	5205-00
Auxiliary Fan	6454-00
Brake Lining Warning	3435-00
Cellular Telephone (Provisions)	6501-00
Central Body Electronics (ZKE)	6100-00
Central Locking System (ZKE)	5126-00
Charging Plug	6331-00
Charging System	1230-00
Check Control	6200-00
Cigar Lighter	6331-01
Component Location Chart	7000-00
Component Location Views	7100-00
Connector Views	8500-00
Crash Controller	6312-01
Cruise Control (EML)	6572-00
Cruise Control (TEMPOMAT)	6571-00
Diagnostic Link	0680-00
Door Lock Heating (ZKE)	5120-00
E-Box Fan	0690-00
Electronic Throttle Control (EML 1.2)	1375-00
Electronic Transmission Control (AEGS)	2460-00
Electronic Transmission Control (AEGS/EML)	2465-00
Fog Light Washer (ZKE)	6167-00
Fuses	
— Fuse 1	0671-00
— Fuse 2	0670-01
— Fuse 3	0670-01
— Fuse 4	0670-02
— Fuse 5	0670-02

— Fuse 6	0670-02
— Fuse 7	0670-02
— Fuse 9	0670-03
— Fuse 10	0670-04
— Fuse 11	0670-04
— Fuse 12	0671-01
— Fuse 13	0670-04
— Fuse 14	0670-04
— Fuse 15	0671-02
— Fuse 16	0671-03
— Fuse 17	0671-04
— Fuse 18	0671-05
— Fuse 19	0670-05
— Fuse 20	0671-06
— Fuse 21	0671-07
— Fuse 22	0671-08
— Fuse 23	0670-04
— Fuse 24	0670-04
— Fuse 25	0670-03
— Fuse 26	0670-03
— Fuse 27	0670-03
— Fuse 28	0671-09
— Fuse 29	0671-10
— Fuse 30	0671-09
— Fuse 31	0671-11
— Fuse 32	0670-09
— Fuse 33	0671-12
— Fuse 34	0670-05
— Fuse 35	0670-06
— Fuse 40	0670-09
— Fuse 41	0670-09
— Fuse 42	0671-13

Fuse 43	0671-13	— X2008	0672-22
— Fuse 44	0671-13	Headlight Washer (ZKE)	6167-00
— Fuse 45	0670-09	Heated Seats	5203-00
— Fuse 46	0670-08	Horn	6133-00
— Fuse 47	0670-08	IHKA Air Delivery	6450-10
— Fuse 50	0670-09	IHKA Auxiliary Water Pump	6450-25
Gauges		IHKA Blower Control	6450-04
— Fuel	6200-06	IHKA Compressor Controls	6450-20
— Fuel Economy	6200-04	IHKA Diagnostic Link and Starter Input	6450-28
— Speedometer	6200-04	IHKA Front Window Defogger	6450-24
— Tachometer	6200-08	IHKA Ground	6450-03
— Temperature	6200-08	IHKA Power	6450-00
Ground Distribution		IHKA Temperature Controls	6450-07
— X165	0672-00	IHKA Water Valves	6450-26
— X166	0672-02	Indicators	
— X167	0672-03	— "ABS"	3450-02
— X172	0672-04	— "Air Bag"	3234-00
— X173	0672-05	— "Brake" Lining Wear	3435-00
— X490	0672-06	— "Check Engine"	6200-00
— X491	0672-08	— Charge	1230-00
— X492	0672-09	— Electronic Transmission (AEGS)	2460-02
— X493	0672-11	— Electronic Transmission (AEGS/EML)	2465-00
— X494	0672-13	— "EML"	6200-02
— X497	0672-15	— Fog Lights	6313-03
— X498	0672-18	— Gear Selector	6200-10
— X814	0672-20	— High Beam	6313-00
— X818	0672-22	— Left Turn	6312-02
— X905	0672-22	— Low Fuel Warning	6200-06
— X1541	0672-23	— Oil Pressure Warning	6200-00
— X1542	0672-24	— Park Brake	6200-00
— X1620	0672-25		
— X1621	0672-27		

— Right Turn	6312-02
Infrared Locking (IRS)	6610-00
Injection Electronics (DME 1.3)	1360-00
Injection Electronics (DME/EML 1.2)	1367-00
Instrument Cluster	6200-00
Interior Lights (ZKE)	6330-00
Lamp Monitor (LKM)	6301-00
Lights	
— Ashtray	6331-01
— Back Up	6322-00
— Brake	6325-00
— Cigar Lighter	6331-01
— Charging Plug	6331-00
— Fog	6313-03
— Glove Box	6331-00
— Hazard	6312-00
— Headlights	6313-00
— Interior (ZKE)	6330-00
— License	6320-00
— Marker	6314-00
— Park	6314-00
— Tail	6314-00
— Turn	6312-00
— Trunk	6320-02
— Underhood	6314-03

Light Switch Details	6300-03
Lumbar Support	5202-00
Memory Mirrors	5119-00
Memory Seat	5201-00
On-Board Computer	6581-00
Park Ventilation	6413-00
Power Distribution Chart	0660-00
Power Distribution	0670-00
Power Assist Steering (Servotronic)	3240-00
Power Seats	5200-00
Power Windows (ZKE)	5133-00
Radio/CD Player (Provisions)	6500-00
Rear Window Defogger (IHKA)	6420-00
Splice Location Views	8000-00
Start	1240-00
Sunroof (ZKE)	5410-00
Supplemental Restraint System (Air Bag)	3234-00
Windshield Washer (ZKE)	6166-00
Windshield Washer Jet Heaters	6169-00
Windshield Wipers (ZKE)	6161-00
Windshield Wiper Pressure Control (ZKE)	6168-00

The purpose of this manual is to provide information to aid in electrical troubleshooting. It consists of schematics, component location information, harness routing views and connector views.

The manual is divided into sections called cells. In each cell electrical components that work together are shown together on one or more schematics. At the top of the page is the fuse (positive) that powers the circuit. The flow of current is shown through all wires, connectors, switches, and motors to ground (negative) at the bottom of the page.

Within the schematic all switches and sensors are shown "at rest," as though the Ignition Switch were off. For identification, component names are underlined and placed next to or above each component. Notes are included that describe how or when switches and other components work.

The Power Distribution schematics show the current feed through all the connections from the Battery and Alternator to each fuse and the Ignition and

Light Switches. If a Power Distribution schematic is combined with any other circuit schematic, a complete picture is made of how that circuit works. The Ground Distribution schematics show how several circuits are connected to common grounds. All wiring between components is shown exactly as it exists in the vehicles; however, the wiring is not drawn to scale. To aid in understanding electrical operation, wiring inside complicated components has been simplified. Further information regarding schematic symbols and references can be found in cell 0140 (Symbols).

With this car, BMW introduces the Central Body Electronics System. This system incorporates the use of a single module that controls many apparently unrelated functions. For instance, the Sunroof and Windshield Wipers are controlled by the same module. However, only the portion of the module that controls the Sunroof will appear in the Sunroof schematics.



INTRODUCTION

Component Identification Information begins in cell 7000 and consists of the Component Location List, Component Location Photographs, and Harness Connector Faces. The Component Location List helps you find where the parts of the circuit are in the vehicle. A brief description of the location is given along with a reference to the photograph that shows the component and its connecting wires. The Harness Connector Faces show the cavity or terminal locations of all connectors having three or more pins. Harness Connector Faces help you locate test points. The drawings show the connector faces you see after the harness connector has been disconnected from a component.

TROUBLESHOOTING PROCEDURES

Diagnostic procedures for many of the circuits in this manual are included with the schematics. These procedures are based on a logical problem-solving procedure. The steps listed below are provided for those circuits that do not include diagnostic procedures. Following these steps will enable you to make a quick diagnosis of the problem.

1. Verify the Problem

Operate the problem circuit to check the accuracy of the complaint. Note the symptoms of the inoperative circuit.

2. Analyze the Problem

Refer to the schematic of the problem circuit in the ETM. Determine how the circuit is supposed to work by tracing the current path(s) from the power feed through the circuit components to ground. Then, based on the symptoms you noted in step 1 and your understanding of circuit operation, identify one or more possible causes of the problem.

3. Isolate the Problem

Make circuit tests to prove or disprove the preliminary diagnosis made in step 2. Keep in mind that a logical, simple procedure is the key to efficient troubleshooting. Test for the most likely cause of failure first. Try to make tests at points which are easily accessible.

4. Repair the Problem

Once the specific problem is identified, make the repair using the proper tools and safe procedures.

5. Check the Problem

Operate the circuit to check for satisfactory circuit operation. Good repair practice calls for rechecking all circuits you have worked on.

TROUBLESHOOTING TOOLS

Isolating the problem (Step 3 of TROUBLESHOOTING PROCEDURES) requires the use of a voltmeter and/or ohmmeter. A voltmeter measures voltage at selected points in a circuit. An ohmmeter measures a circuit's resistance to current flow. It has an internal battery that provides current to the circuit under test. Disconnect the car battery when using an ohmmeter because the battery voltage will cause the ohmmeter to give false readings. Also, do not use an ohmmeter on solid state components. The voltage that the ohmmeter applies to the circuit could damage these components.

Fused Jumper Wire

A jumper wire is made up of an in-line fuse holder connected to a set of test leads. It should have a five ampere fuse. Use it for bypassing open circuits. Never use a jumper wire across any load (motors, etc.). This direct battery short will blow the fuse.

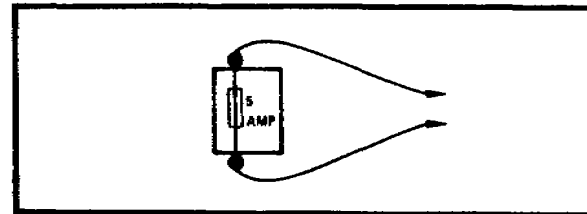

Fused Jumper Wire

TROUBLESHOOTING TESTS

Voltage Test

This test measures voltage in a circuit. By taking measurements at several points (terminals or connectors) along the circuit, you can isolate the problem.

To take a voltage measurement, connect the negative lead of the voltmeter to the battery's negative terminal or other known good ground. Then connect the positive lead of the voltmeter to the point you want to test. The voltmeter will measure the voltage present at that point in the circuit.

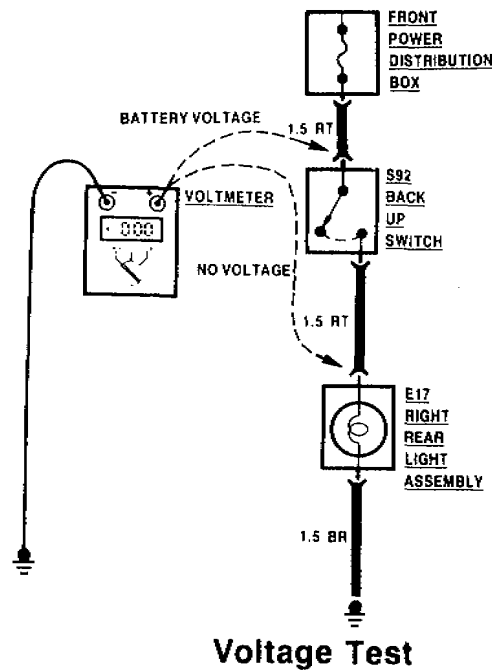

Voltage Drop Test

Wires, connectors, and switches are designed to conduct current with a minimum loss of voltage. A voltage drop of more than one volt indicates a problem.

To test for voltage drop, connect the voltmeter leads to connectors at either end of the circuit's suspected problem area. The positive lead should be connected to the connector closest to the power source. The voltmeter will show the voltage drop between these two points. Any switches in the circuit should be on during this test.

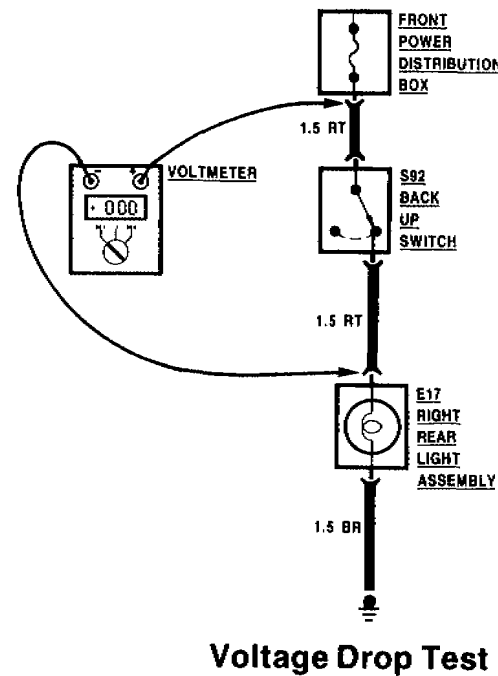

Continuity Test

To perform a continuity test, first disconnect the car battery. Then, while holding the leads together, adjust the ohmmeter to read zero. Connect the ohmmeter leads to connector or terminals at either end of the circuit's suspected problem area. The ohmmeter will show the resistance across that part of the circuit. This test can also be performed with a self-powered test light.

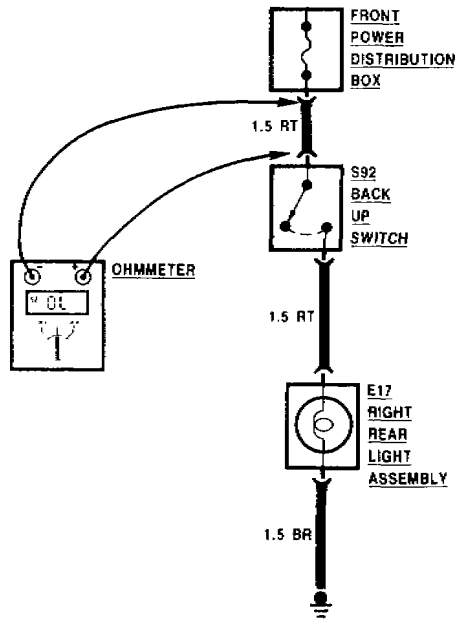

Continuity Test

Short Test Using voltmeter

To locate a wiring short to ground, remove the blown fuse and disconnect the load. Connect the voltmeter leads to the fuse terminals. The positive lead should be connected to the terminal closest to the power source.

Starting near the FRONT POWER DISTRIBUTION BOX, move the wire harness back and forth and watch the voltmeter reading. If the voltmeter registers a reading, there is a short to ground in the wiring. Somewhere in the area of the harness being moved, the wire insulation is worn away and the circuit is grounding.

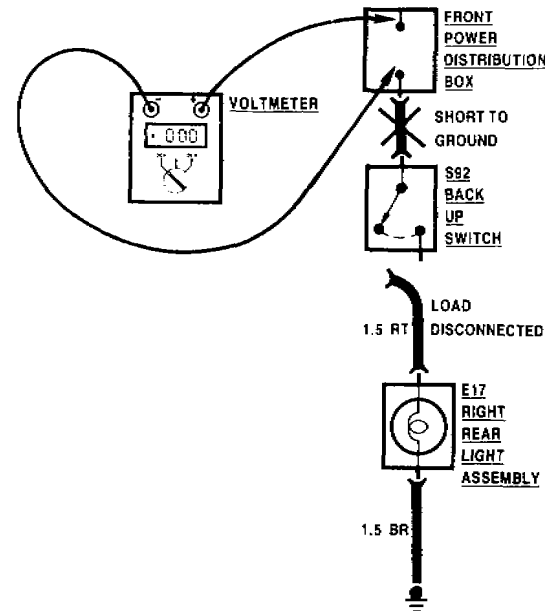

Short Test Using Voltmeter

Short Test Using Ohmmeter

Disconnect the battery. While holding the leads together, adjust the ohmmeter to read zero. Remove the blown fuse and disconnect the load. Connect one lead of the ohmmeter to the fuse terminal that is closest to the load. Connect the other lead to a known good ground. Starting near the FRONT POWER DISTRIBUTION BOX, move the wire harness back and forth and watch the ohmmeter reading. Low or no resistance indicates a short to ground in the wiring. Infinitely high resistance indicates no short.

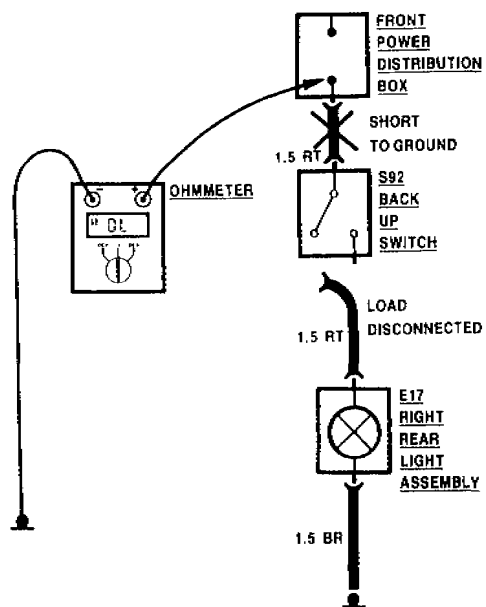

Short Test Using Ohmmeter

Current Test Using Ammeter

To measure the current, connect the ammeter leads to the connector or terminals in series with the circuit. The ammeter will show the current through the circuit.

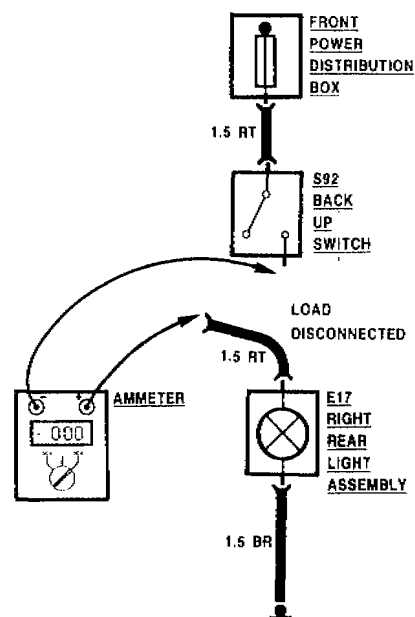

Current Test Using Ammeter

SYMBOLS

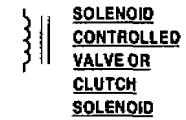
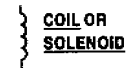
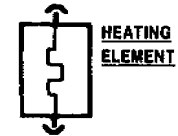
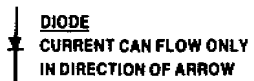
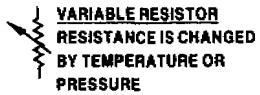
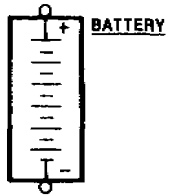



SYMBOLS



ENTIRE COMPONENT SHOWN

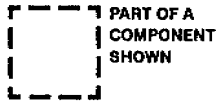

PART OF A COMPONENT SHOWN

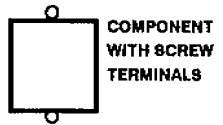

COMPONENT WITH SCREW TERMINALS

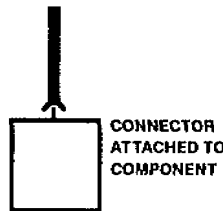

CONNECTOR ATTACHED TO COMPONENT

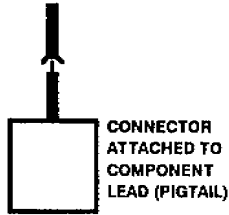

CONNECTOR ATTACHED TO COMPONENT LEAD (PIGTAIL)

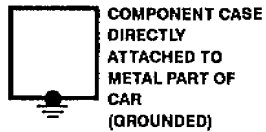

COMPONENT CASE DIRECTLY ATTACHED TO METAL PART OF CAR (GROUNDED)

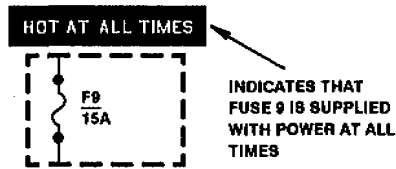

TERMINAL NUMBER	DESCRIPTION
50	VOLTAGE: IGNITION SWITCH IN START
30	VOLTAGE: SUPPLIED AT ALL TIMES
15	VOLTAGE: IGNITION SWITCH IN RUN OR START
15E	VOLTAGE: IGNITION SWITCH IN RUN
R	VOLTAGE: IGNITION SWITCH IN ACCESSORY, RUN OR START
31	GROUND

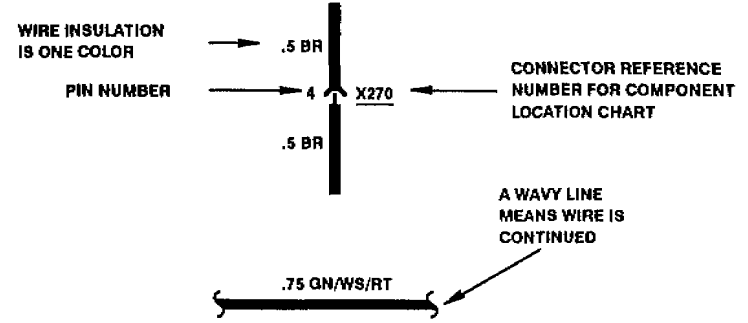

1. FIRST COLOR IS THE WIRE INSULATION.
2. SECOND COLOR IS THE "TRACER" OR "STRIPE" COLOR.
3. THIRD COLOR IS THE "DOTS" COLOR

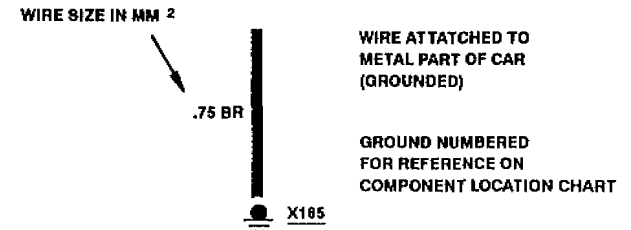
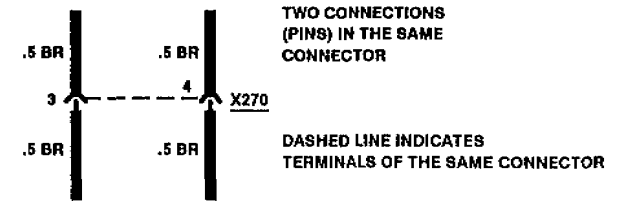



SYMBOLS

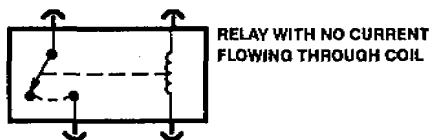
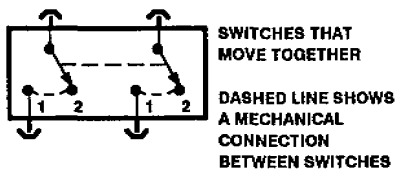
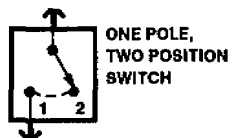

WHEN COIL IS
ENERGIZED, SWITCH
IS PULLED CLOSED

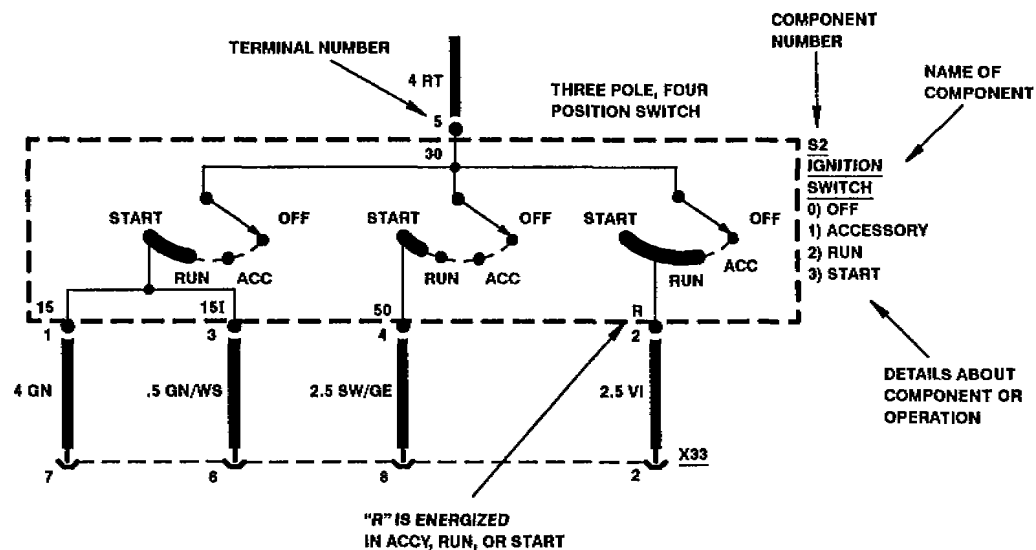
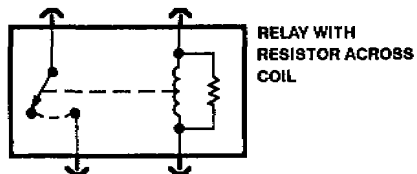

TERMINAL NUMBER	DESCRIPTION
50	VOLTAGE: IGNITION SWITCH IN START
30	VOLTAGE: SUPPLIED AT ALL TIMES
15	VOLTAGE: IGNITION SWITCH IN RUN OR START
15I	VOLTAGE: IGNITION SWITCH IN RUN
R	VOLTAGE: IGNITION SWITCH IN ACCESSORY, RUN, OR START
31	GROUND

SYMBOLS

HOT IN ACC, RUN OR START

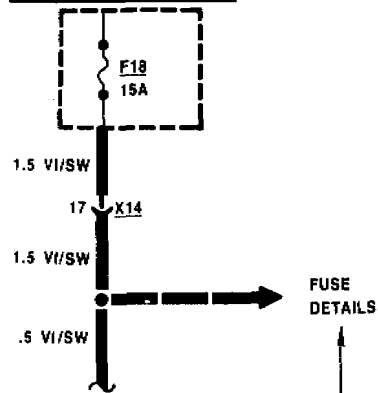

OTHER CIRCUITS WHICH SHARE FUSE 18, BUT ARE NOT SHOWN, CAN BE REFERENCED IN FUSE DETAILS

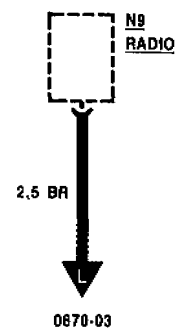
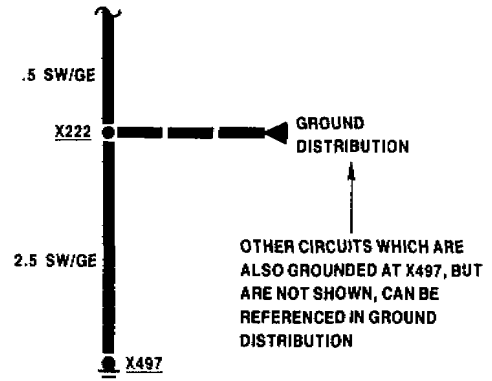

CURRENT PATH IS CONTINUED AS LABELED

ARROW SHOWS DIRECTION OF CURRENT FLOW AND IS REPEATED WHERE CURRENT PATH CONTINUES

CIRCUIT REFERENCE — A WIRE WHICH CONNECTS TO ANOTHER CIRCUIT

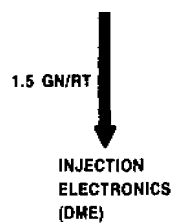

HOT IN ACC, RUN OR START

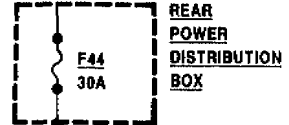

TESTER COMMAND NUMBER- ENTERING 315 FOR THE GIVEN ZKE SYSTEM WILL ACTIVATE THE TRANSISTORIZED SWITCH

CENTRAL BODY ELECTRONICS (ZKE)

SYMBOL INDICATES A SOLID STATE DEVICE (INCLUDES ONLY ELECTRONIC PARTS)

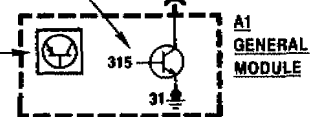

CIRCUIT SHOWN IS INCOMPLETE COMPLETE CIRCUIT CAN BE REFERENCED IN CENTRAL BODY ELECTRONICS (ZKE)

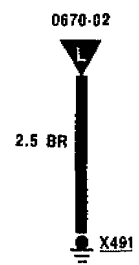



POWER DISTRIBUTION CHARTS

FRONT POWER DISTRIBUTION BOX

FRONT POWER DISTRIBUTION BOX

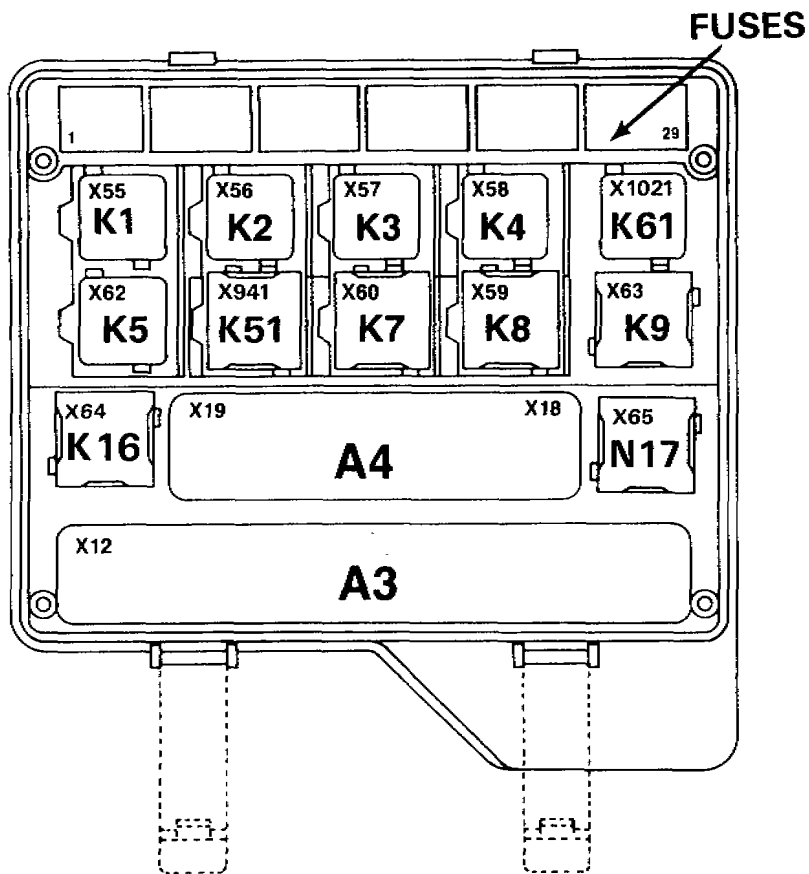

COMPONENTS IN FRONT POWER DISTRIBUTION BOX		
NUMBER	CONNECTOR	DESCRIPTION
A3	X12	LAMP CONTROL MODULE
A4	X18, X19	CHECK CONTROL MODULE
K1	X55	STARTER RELAY
K2	X56	HORN RELAY
K3	X57	UNLOADER RELAY, KLR
K4	X58	BLOWER RELAY
K5	X62	WASHER PUMP RELAY
K7	X60	PARKING LIGHT MONITOR RELAY
K8	X59	FRONT DEFOGGER/WATER PUMP RELAY
K9	X63	UNLOADER RELAY, KL15
K16	X64	HAZARD FLASHER RELAY
K51	X941	PHONE ALERT RELAY
K61	X1021	UNLOADER RELAY, KL61
N17	X65	CRASH CONTROL UNIT



POWER DISTRIBUTION CHARTS

REAR POWER DISTRIBUTION BOX

REAR POWER DISTRIBUTION BOX

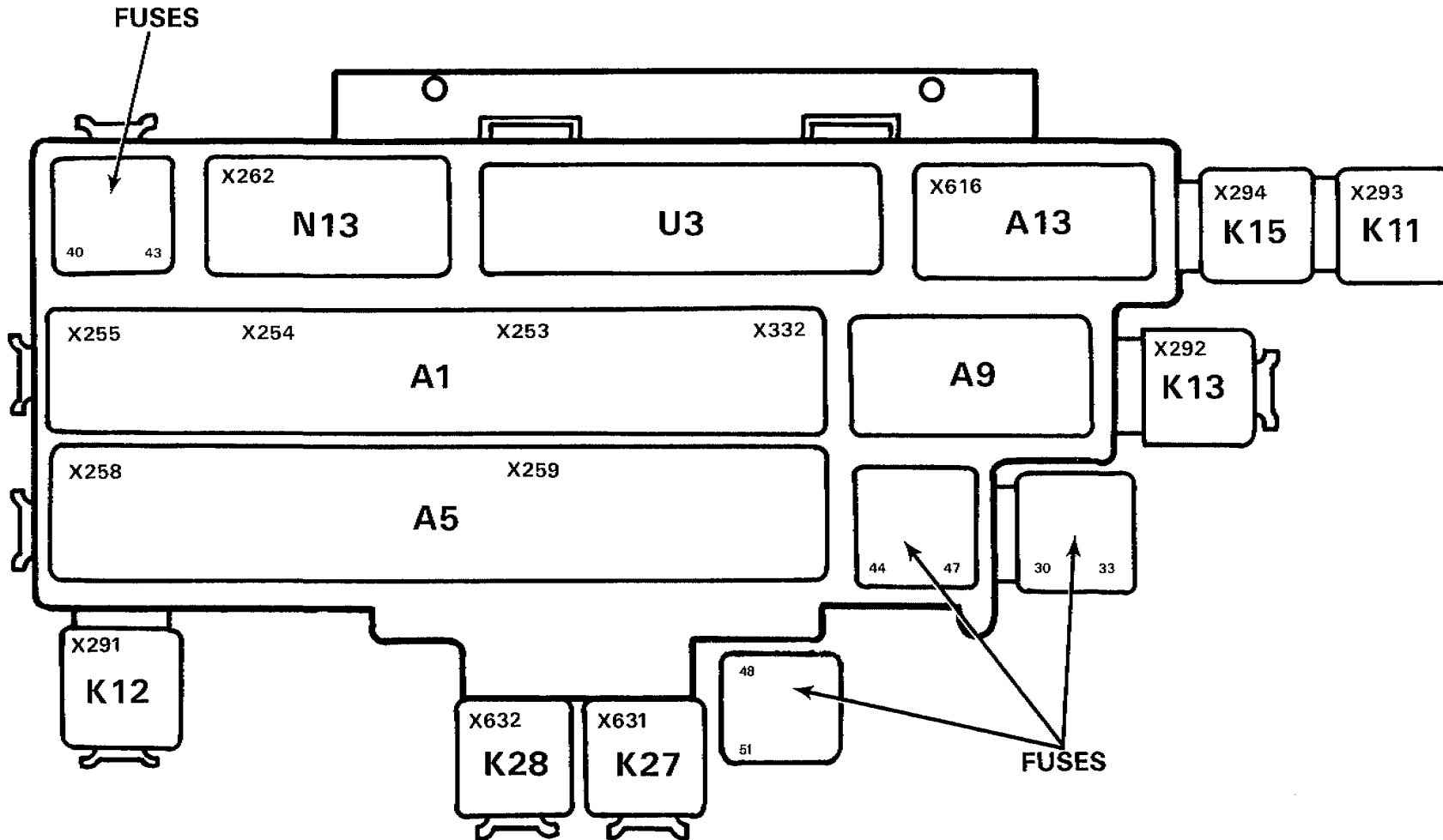



POWER DISTRIBUTION CHARTS

REAR POWER DISTRIBUTION BOX

COMPONENTS IN REAR POWER DISTRIBUTION BOX		
NUMBER	CONNECTOR	DESCRIPTION
A1	X253, X254, X255, X332	GENERAL MODULE
A5	X258, X259	RELAY MODULE
A9		PRESENTLY NOT AVAILABLE
A13	X616	REAR HEADREST CONTROL UNIT
K11	X293	WIPER RELAY
K12	X291	WIPER PRESSURE CONTROL RELAY (ADV)
K13	X292	REAR DEFOGGER RELAY
K15	X294	ELECTRIC POWER PROTECTION RELAY
K27	X631	LEFT REAR SEAT HEATING/ POSITION RELAY
K28	X632	RIGHT REAR SEAT HEATING/ POSITION RELAY
N13	X262	INFRARED LOCKING CONTROL UNIT
U3		PRESENTLY NOT AVAILABLE



POWER DISTRIBUTION CHARTS

AUXILIARY RELAY BOX

AUXILIARY RELAY BOX

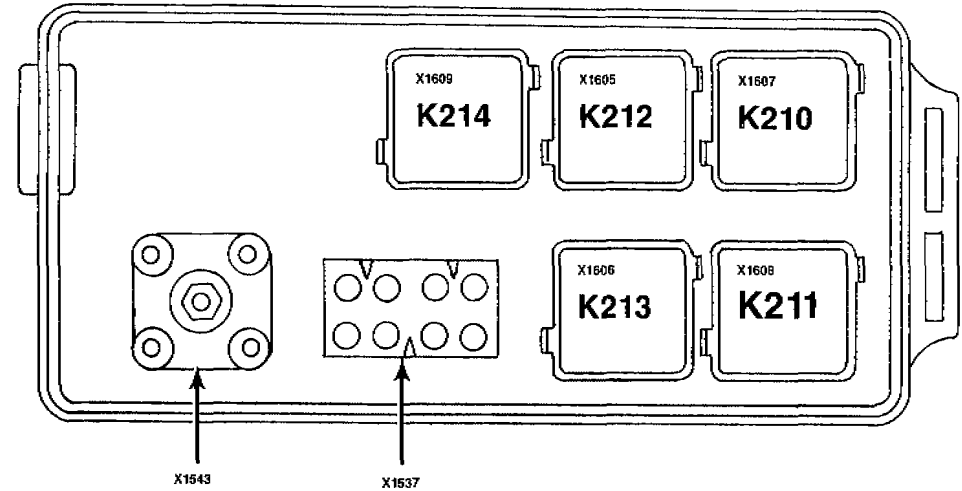
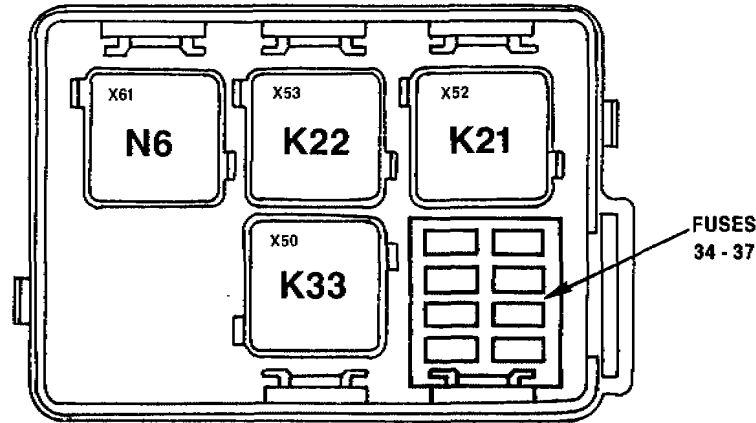

COMPONENTS IN AUXILIARY RELAY BOX

NUMBER	CONNECTOR	DESCRIPTION
K21	X52	NORMAL SPEED RELAY
K22	X53	HIGH SPEED RELAY
K33	X50	AIR CONDITIONING MOTRONIC RELAY
N6	X61	HEADLIGHT/FRONT FOGLIGHT MODULE (SRA)

COMPONENTS IN AUXILIARY RELAY BOX, 750iL ONLY

NUMBER	CONNECTOR	DESCRIPTION
K210	X1607	FUEL PUMP RELAY I
K211	X1608	FUEL PUMP RELAY II
K212	X1605	MAIN RELAY I
K213	X1606	MAIN RELAY II
K214	X1609	OXYGEN SENSOR RELAY
—	X1537	CONNECTOR (8 PINS)
X1543	—	B + JUNCTION POST



FUSE CHARTS

Fuse No.	Size	Circuit Protected
1	15A	Antilock Brake System (ABS) (Also Fuse 17) Brake Lights Brake Lining Warning (Also Fuses 17 and 20) Cruise Control (Tempomat) (Also Fuse 17) Cruise Control (EML) Electronic Throttle Control (EML 1.2) (Also Fuses 17 and 20) Instrument Cluster/Check Control (Also Fuses 12, 15, 17, 20, 29, and 33) Lamp Monitor (LKM) (Also Fuses 2, 3, 4, 5, 7, 10, 11, 13, and 14) Park/Tail/Underhood Lights (Also Fuses 4, 5, and 20)
2	7.5A	Headlights/Fog Lights (Also Fuses 3, 5, 7, 10, 11, 13 and 14) Lamp Monitor (LKM) (Also Fuses 1, 3, 4, 5, 7, 10, 11, 13 and 14) Turn/Hazard Lights (Also Fuses 3, 6, 13 and 14)
3	7.5A	Headlights/Fog Lights (Also Fuses 2, 5, 7, 10, 11, 13 and 14) Headlight/Fog Light Washer (ZKE) (Also Fuses 5, 17, 22 and 44) Lamp Monitor (LKM) (Also Fuses 1, 2, 4, 5, 7, 10, 11, 13 and 14) Turn/Hazard Lights (Also Fuses 2, 6, 13 and 14)
4	7.5A	Lamp Monitor (LKM) (Also Fuses 1, 2, 3, 5, 7, 10, 11, 13 and 14) Park/Tail/Marker/Underhood Lights (Also Fuses 1, 5 and 20)



FUSE CHARTS

Fuse No.	Size	Circuit Protected
5	10A	Glove Box Light/Cigar Lighter/Ashtray Light/Charging Plug (Also Fuses 4, 26 and 33) Headlights/Fog Lights (Also Fuses 2, 3, 7, 10, 11, 13 and 14) Headlight/Fog Light Washer (ZKE) (Also Fuses 3, 17, 22 and 44) Heated Seats (Also Fuse 16) Lamp Monitor (LKM) (Also Fuses 1, 2, 3, 4, 7, 10, 11, 13 and 14) License/Trunk Lights (Also Fuse 33) Lumbar Support (Also Fuse 16) Park/Tail/Underhood Lights (Also Fuses 1, 4 and 20)
6	7.5A	Turn/Hazard Lights (Also Fuses 2, 3, 13 and 14)
7	15A	Headlights/Fog Lights (Also Fuses 2, 3, 5, 10, 11, 13 and 14) Lamp Monitor (LKM) (Also Fuses 1, 2, 3, 4, 5, 10, 11, 13 and 14)
9	15A	Automatic Climate Control (IHKA) (Also Fuses 9, 19, 20, 21 and 29) Auxiliary Fan (Also Fuses 25 and 29) Cellular Telephone (Provisions) (Also Fuses 18 and 31) Horn
10	7.5A	Headlights/Fog Lights (Also Fuses 2, 3, 5, 7, 11, 13 and 14) Lamp Monitor (LKM) (Also Fuses 1, 2, 3, 4, 5, 7, 11, 13 and 14)
11	7.5A	Headlights/Fog Lights (Also Fuses 2, 3, 5, 7, 10, 13 and 14) Lamp Monitor (LKM) (Also Fuses 1, 2, 3, 4, 5, 7, 10, 13 and 14)
12	15A	Back Up Lights Instrument Cluster/Check Control (Also Fuses 1, 15, 17, 20, 29 and 33) Memory Mirrors (Also Fuses 16, 17, 18, 30, 42 and 44)
13	7.5A	Headlights/Fog Lights (Also Fuses 2, 3, 5, 7, 10, 11 and 14) Lamp Monitor (LKM) (Also Fuses 1, 2, 3, 4, 5, 7, 10, 11 and 14) Turn/Hazard Lights (Also Fuses 2, 3, 6 and 14)
14	7.5A	Headlights/Fog Lights (Also Fuses 2, 3, 5, 7, 10, 11 and 13) Lamp Monitor (LKM) (Also Fuses 1, 2, 3, 4, 5, 7, 10, 11 and 13) Turn/Hazard Lights (Also Fuses 2, 3, 6 and 13)
15	7.5A	Instrument Cluster/Check Control (Also Fuses 1, 12, 17, 20, 29 and 33) On-Board Computer (Also Fuses 17 and 20) Windshield Washer (ZKE) (Also Fuse 44) Windshield Wipers (ZKE) (Also Fuse 44)

BMW
7 **FUSE CHARTS**

Fuse No.	Size	Circuit Protected
16	30A	Heated Seats (Also Fuse 5) Lumbar Support (Also Fuse 5) Memory Mirrors (Also Fuses 12, 17, 18, 30, 42 and 44) Memory Seat (Also Fuses 17, 18, 30, 42 and 44)
17	7.5A	Antilock Brake System (ABS) (Also Fuse 1) Antitheft System (DWA) (Also Fuses 18, 20 and 31) Brake Lining Warning (Also Fuses 1 and 20) Central Body Electronics (ZKE) (Also Fuses 30, 44, and 47) Charging System (Also Fuse 28) Cruise Control (Tempomat) (Also Fuse 1) Door Lock Heating (ZKE) (Also Fuse 30) E-Box Fan (Also Fuse 28) Electronic Throttle Control (EML 1.2) (Also Fuses 1 and 20) Electronic Transmission Control (AEGS) Electronic Transmission Control (AEGS/EML) Headlight/Fog Light Washer (ZKE) (Also Fuses 3, 5, 22, and 44) Infrared Locking System (IRS) (Also Fuses 18 and 31) Injection Electronics (DME 1.3) (Also Fuse 23) Injection Electronics (DME/EML 1.2) (Also Fuses 23, and 24) Instrument Cluster/Check Control (Also Fuses 1, 12, 15, 20, 29, and 33) Interior Lights (ZKE) (Also Fuses 18, 30, 33, and 44) Memory Mirrors (Also Fuses 12, 16, 18, 30, 42, and 44) Memory Seat (Also Fuses 16, 18, 30, 42, and 44) On-Board Computer (Also Fuses 15 and 20) Power Windows (ZKE) (Also Fuses 20, 30, 31, and 44) Start Sunroof (ZKE) (Also Fuses 20, 30, 31, and 44)
18	15A	Antitheft System (DWA) (Also Fuses 17, 20, and 31) Cellular Telephone (Provisions) (Also Fuses 9 and 31) Infrared Locking (IRS) (Also Fuses 17 and 31) Interior Lights (ZKE) (Also Fuses 17, 30, 33 and 44) Memory Mirrors (Also Fuses 12, 16, 17, 30, 42, and 44) Memory Seat (Also Fuses 16, 17, 30, 42, and 44) Radio/CD Player (Provisions) (Also Fuse 41)
19	30A	Automatic Climate Control (IHKA) (Also Fuses 8, 9, 20, 21, and 29) Park Ventilation (Also Fuses 20 and 21)



FUSE CHARTS

Fuse No.	Size	Circuit Protected
20	7.5A	Antitheft System (DWA) (Also Fuses 17, 18 and 31) Automatic Climate Control (IHKA) (Also Fuses 9, 19, 21 and 29) Brake Lining Warning (Also Fuses 1 and 17) Central Locking System (ZKE) (Also Fuses 30 and 31) Electronic Throttle Control (EML 1.2) (Also Fuses 1 and 17) Instrument Cluster/Check Control (Also Fuses 1, 12, 15, 17, 29 and 33) On-Board Computer (Also Fuses 15 and 17) Park Ventilation (Also Fuses 19 and 21) Park/Tail/Underhood Lights (Also Fuses 1, 4 and 5) Power Windows (ZKE) (Also Fuses 17, 30, 31 and 44) Sunroof (ZKE) (Also Fuses 17, 30, 31 and 44)
21	7.5A	Automatic Climate Control (IHKA) (Also Fuses 9, 19, 20 and 29) Park Ventilation (Also Fuses 19 and 20) Rear Window Defogger (Also Fuses 28 and 46)
22	30A	Headlight/Fog Light Washer (ZKE) (Also Fuses 3, 5, 17 and 44) Windshield Wiper Pressure Control (ZKE) (Also Fuse 44)
23	7.5A	Injection Electronics (DME 1.3) (Also Fuse 17) Injection Electronics (DME/EML 1.2) (Also Fuses 17, 24 and 28)
24	7.5A	Injection Electronics (DME/EML 1.2) (Also Fuses 17, 23 and 28)
25	30A	Auxiliary Fan (Also Fuses 9 and 29)
26	30A	Glove Box Light/Cigar Lighter/Ashtray Light/Charging Plug (Also Fuses 5 and 33)
27	30A	Automatic Rear Headrest (Also Fuses 29 and 40) Power Seats (Also Fuses 29, 40 and 43)
28	15A	Charging System (Also Fuse 17) E-Box Fan (Also Fuse 17) Injection Electronics (DME/EML 1.2) (Also Fuses 17, 23 and 24) Power Assist Steering (Servotronic) Rear Window Defogger (Also Fuses 21 and 46) Windshield Washer Jet Heaters

BMW
7 **FUSE CHARTS**

Fuse No.	Size	Circuit Protected
29	7.5A	Automatic Climate Control (IHKA) (Also Fuses 8, 9, 19, 20, and 21) Automatic Rear Headrest (Also Fuses 27 and 40) Auxiliary Fan (Also Fuses 9 and 25) Instrument Cluster/Check Control (Also Fuses 1, 12, 15, 17, 20, and 33) Power Seats (Also Fuses 27, 40 and 43) Rear Window Defogger (Also Fuses 21 and 46)
30	7.5A	Central Body Electronics (ZKE) (Also Fuses 17, 44, and 47) Central Locking System (ZKE) (Also Fuses 20 and 31) Door Lock Heating (ZKE) (Also Fuse 17) Interior Lights (ZKE) (Also Fuses 17, 18, 33, and 44) Memory Mirrors (Also Fuses 12, 16, 17, 18, 42, and 44) Memory Seat (Also Fuses 16, 17, 18, 42, and 44) Power Windows (ZKE) (Also Fuses 17, 20, 31, and 44) Sunroof (ZKE) (Also Fuses 17, 20, 31, and 44)
31	7.5A	Antitheft System (DWA) (Also Fuses 17, 18, and 20) Cellular Telephone (Provisions) (Also Fuses 9 and 18) Central Locking System (ZKE) (Also Fuses 20 and 30) Infrared Locking System (IRS) (Also Fuses 17 and 18) Power Windows (ZKE) (Also Fuses 17, 20, 30, and 44) Sunroof (ZKE) (Also Fuses 17, 20, 30, and 44)
33	15A	Glove Box Light/Cigar Lighter/Ashtray Light/Flashlight Charging Plug (Also Fuses 5 and 26) Instrument Cluster/Check Control (Also Fuses 1, 12, 15, 17, 20 and 29) Interior Lights (ZKE) (Also Fuses 17, 18, 30 and 44) License/Trunk Lights (Also Fuse 5)
34	15A	Not Used
40	30A	Automatic Rear Headrest (Also Fuses 27 and 29) Power Seats (Also Fuses 27, 29 and 43)
41	30A	Radio/CD Player (Provisions) (Also Fuse 18)
42	30A	Memory Mirrors (Also Fuses 12, 16, 17, 18, 30 and 44) Memory Seat (Also Fuses 16, 17, 18, 30 and 44)
43	30A	Power Seats (Also Fuses 27, 29, 40 and 42)



FUSE CHARTS

Fuse No.	Size	Circuit Protected
44	30A	Central Body Electronics (ZKE) (Also Fuses 17, 30 and 47) Headlight/Fog Light Washer (ZKE) (Also Fuses 3, 5, 17 and 22) Interior Lights (ZKE) (Also Fuses 17, 18, 30 and 33) Memory Mirrors (Also Fuses 12, 16, 17, 18, 30 and 42) Memory Seat (Also Fuses 16, 17, 18, 30 and 42) Power Windows (ZKE) (Also Fuses 17, 20, 30 and 31) Sunroof (ZKE) (Also Fuses 17, 20, 30 and 31) Windshield Washer (ZKE) (Also Fuse 15) Windshield Wipers (ZKE) (Also Fuse 15) Windshield Wiper Pressure Control (ZKE) (Also Fuse 22)
45	30A	Accessory Connector (Not Used)
46	30A	Rear Window Defogger (Also Fuses 21 and 29)
47	30A	Central Body Electronics (ZKE) (Also Fuses 17, 30 and 44)
50	30	Accessory Connector(Not Used)



POWER DISTRIBUTION

FRONT POWER DISTRIBUTION BOX

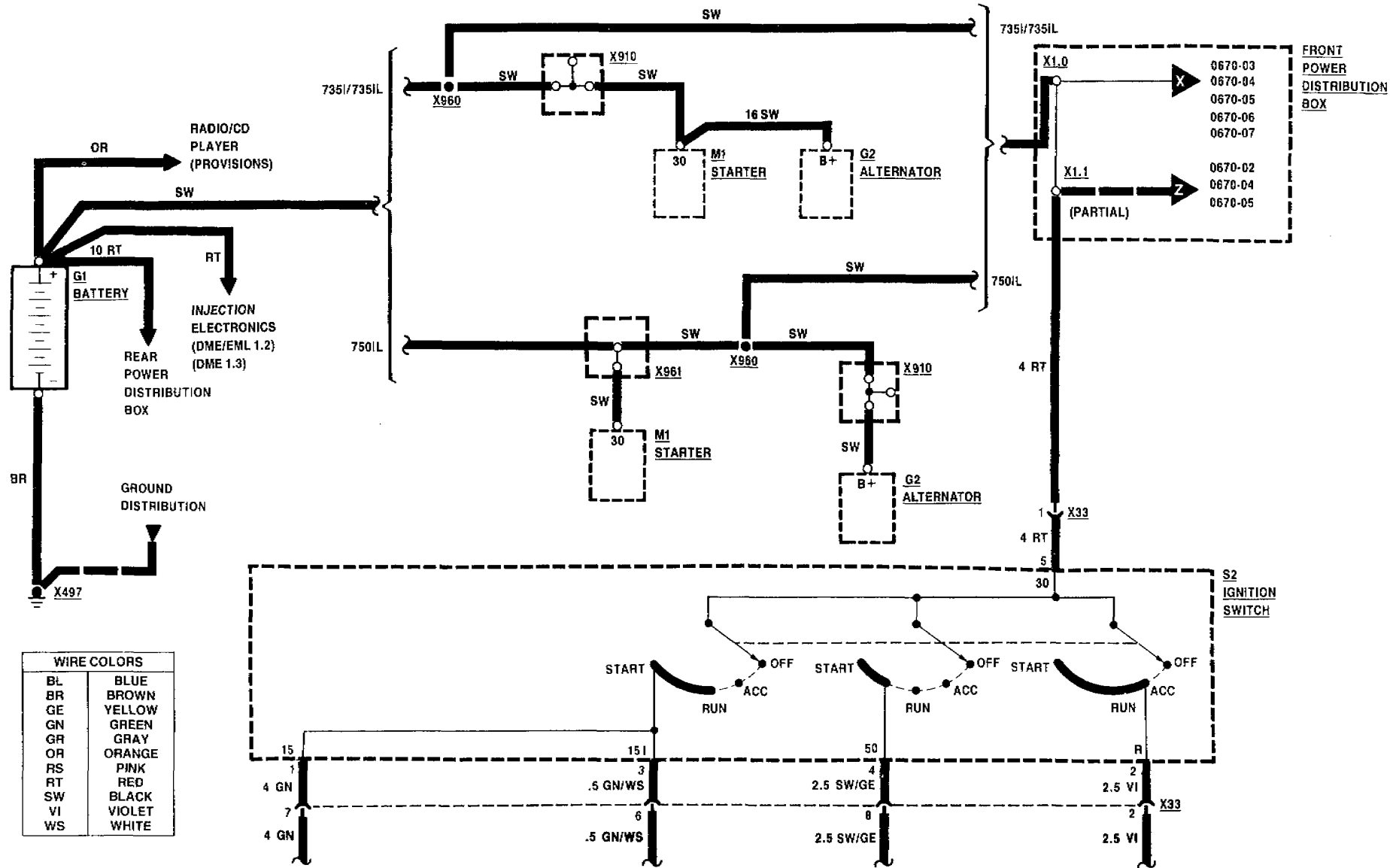

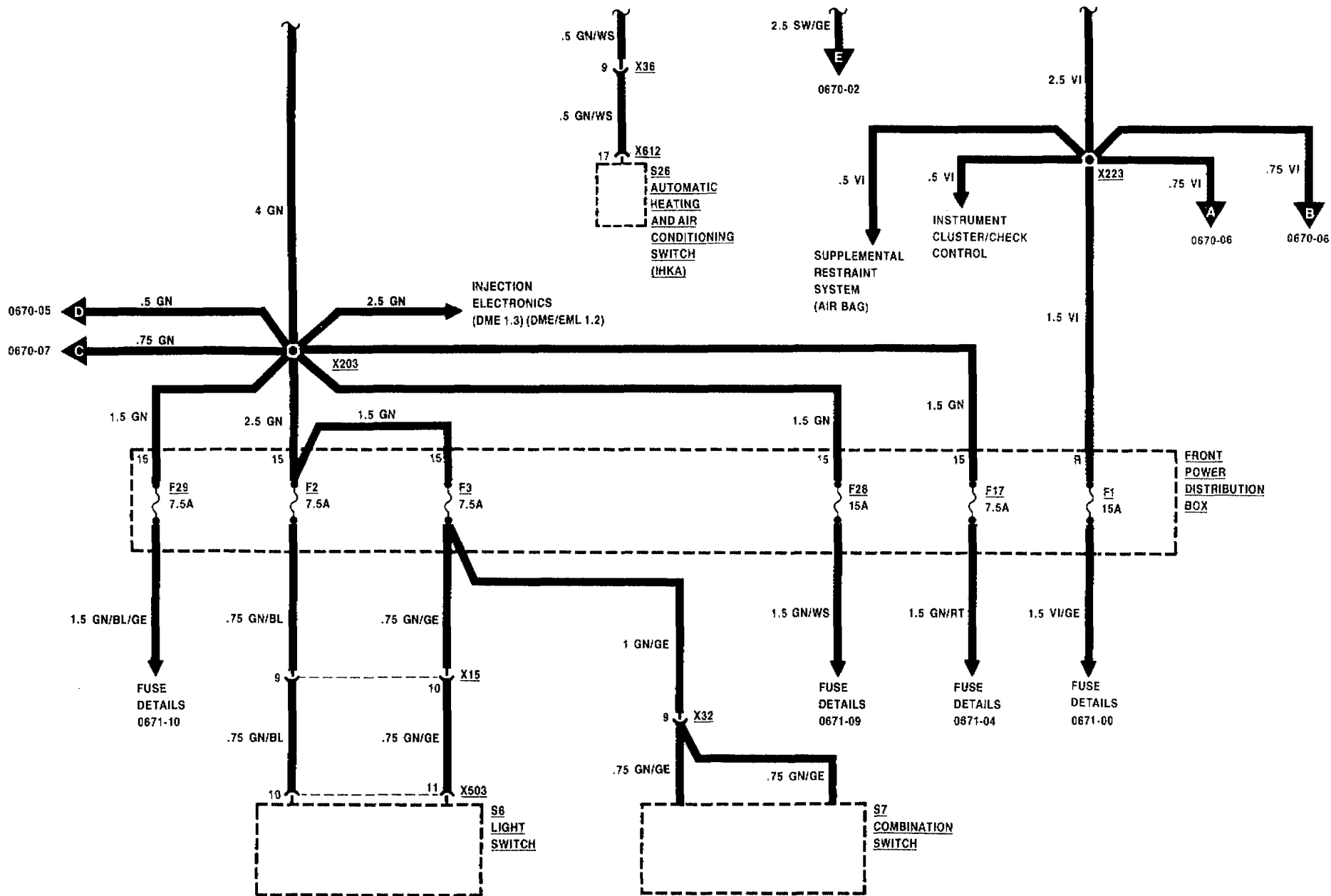

09/88 ————— 0670-01 ————— 1989



POWER DISTRIBUTION FRONT POWER DISTRIBUTION BOX

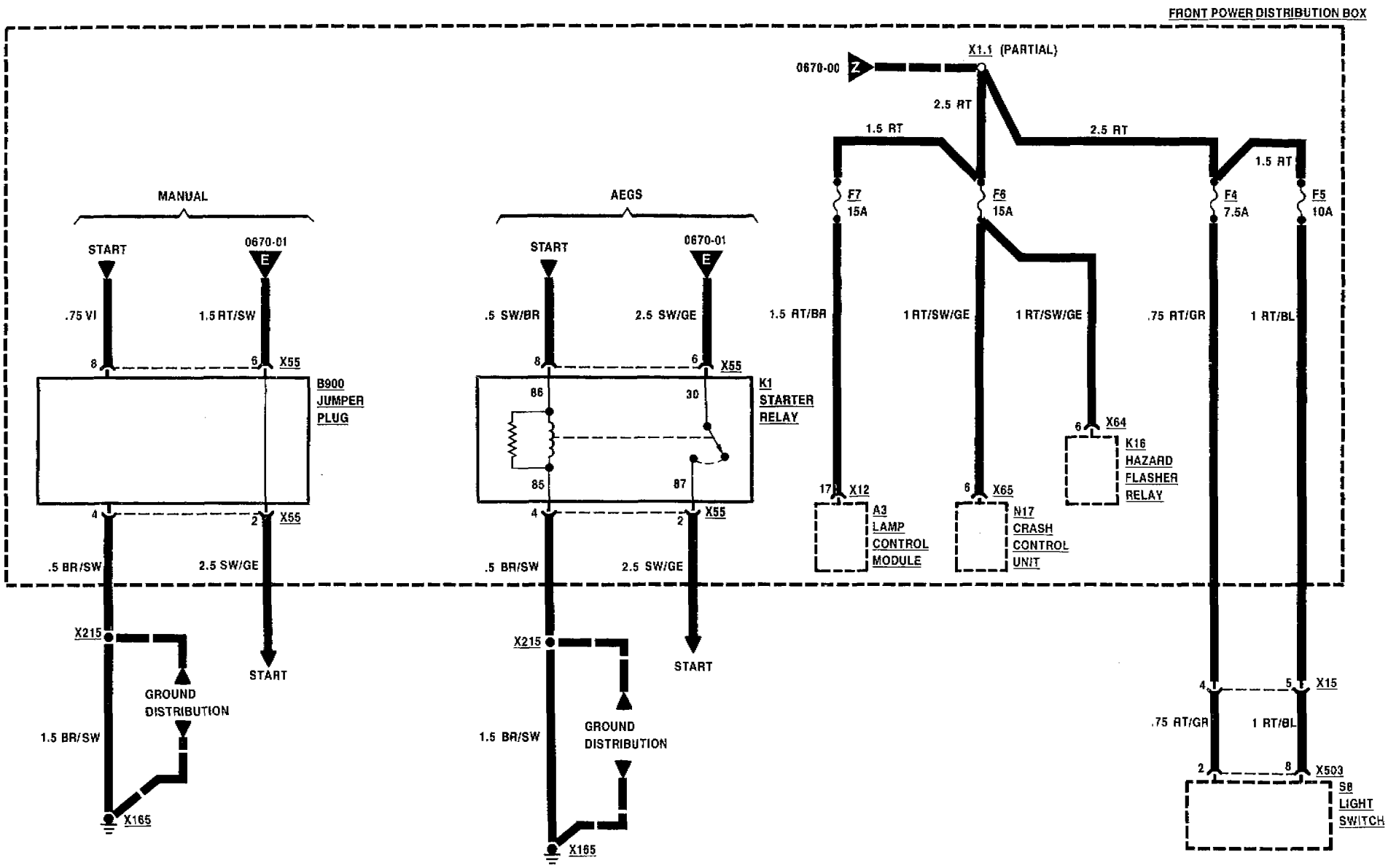



POWER DISTRIBUTION FRONT POWER DISTRIBUTION BOX

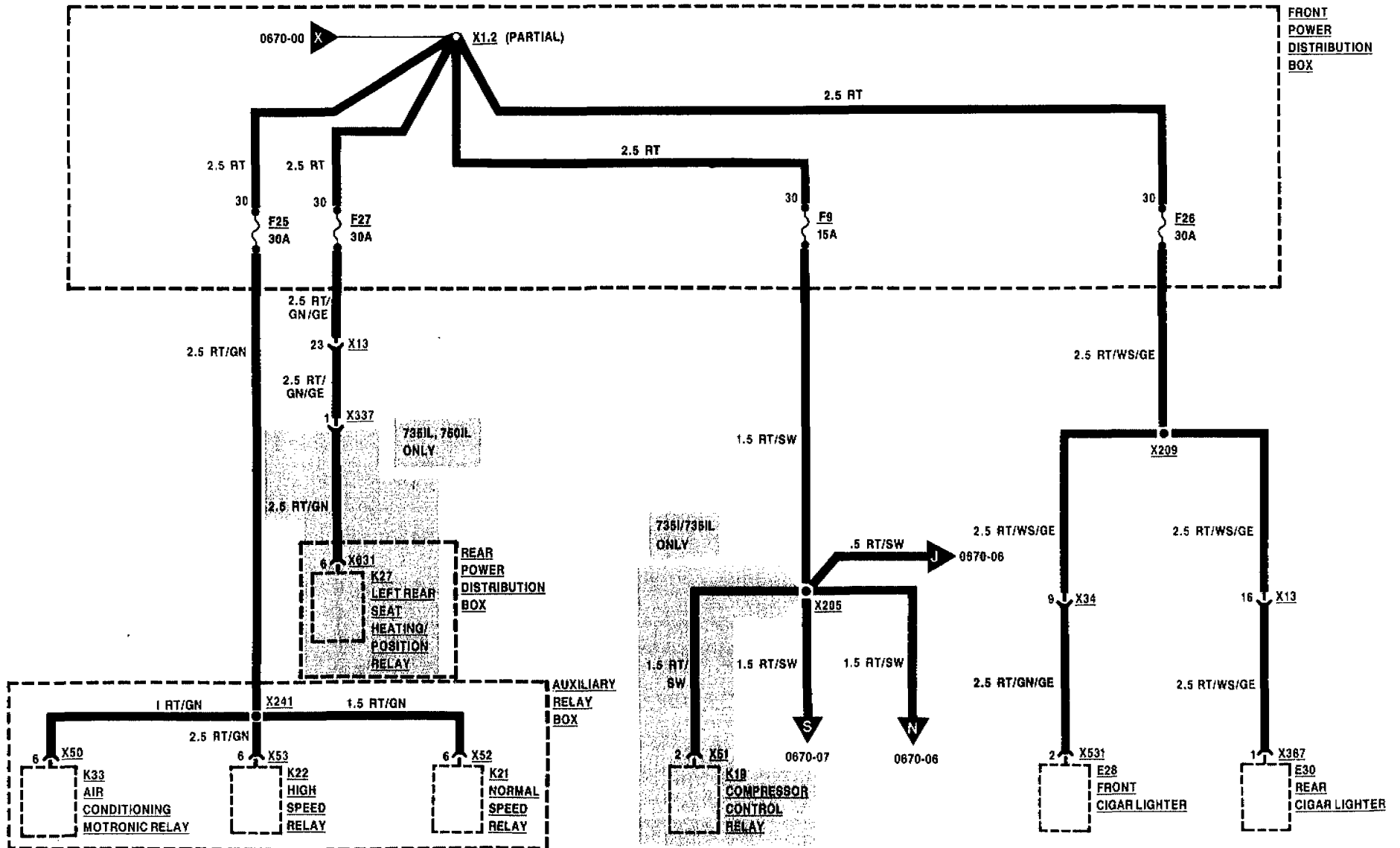



POWER DISTRIBUTION FRONT POWER DISTRIBUTION BOX

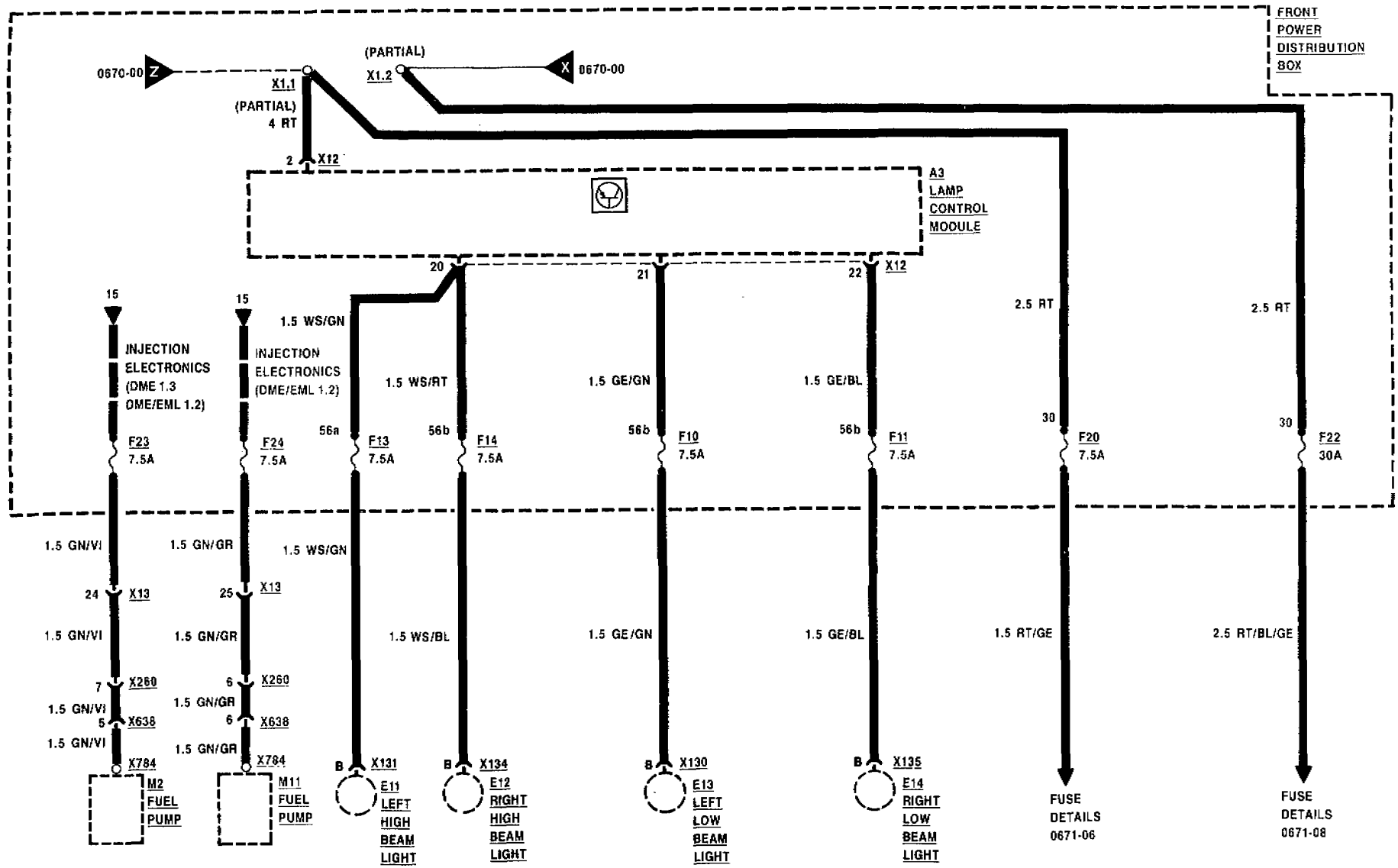



POWER DISTRIBUTION FRONT POWER DISTRIBUTION BOX

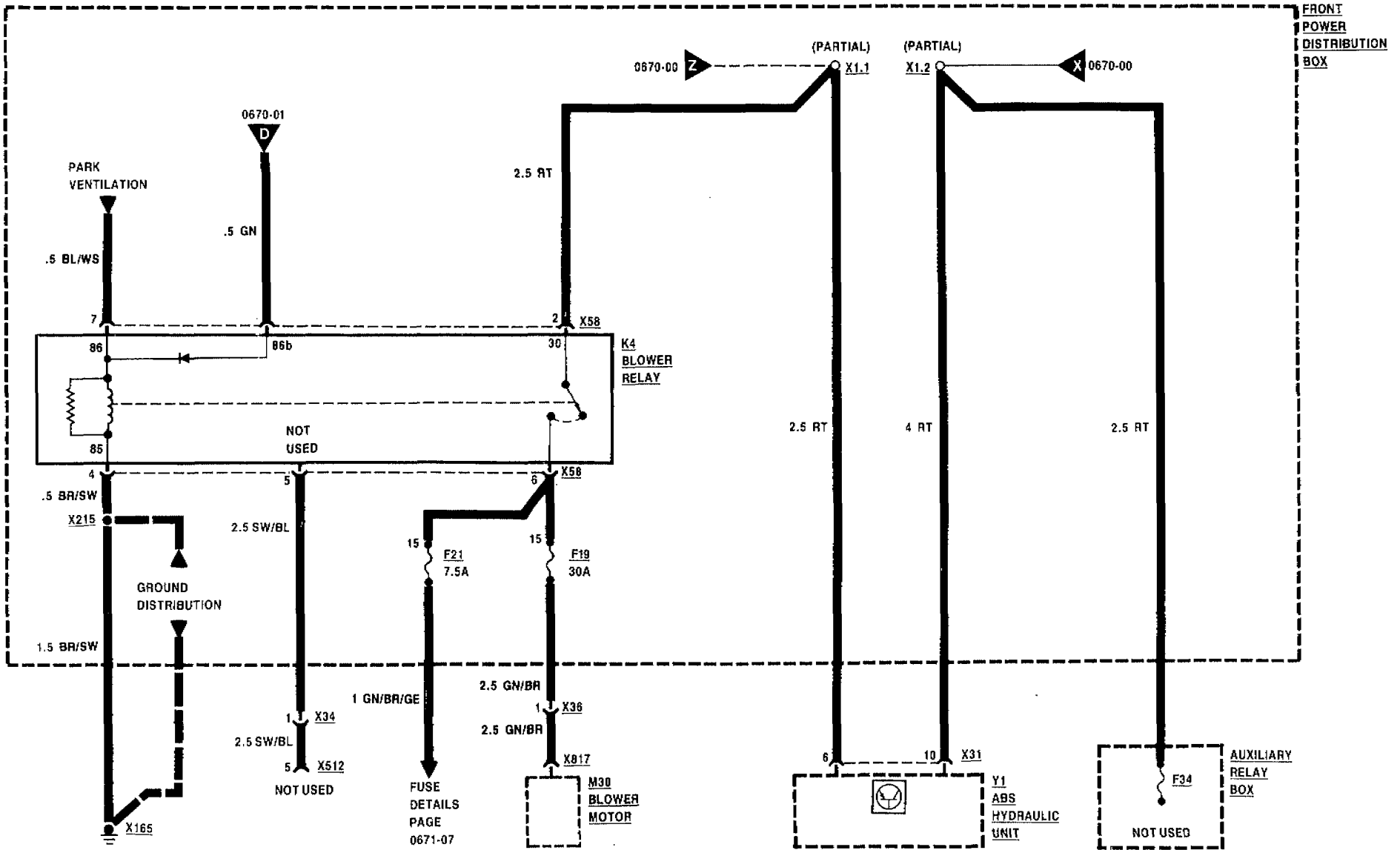



POWER DISTRIBUTION FRONT POWER DISTRIBUTION BOX

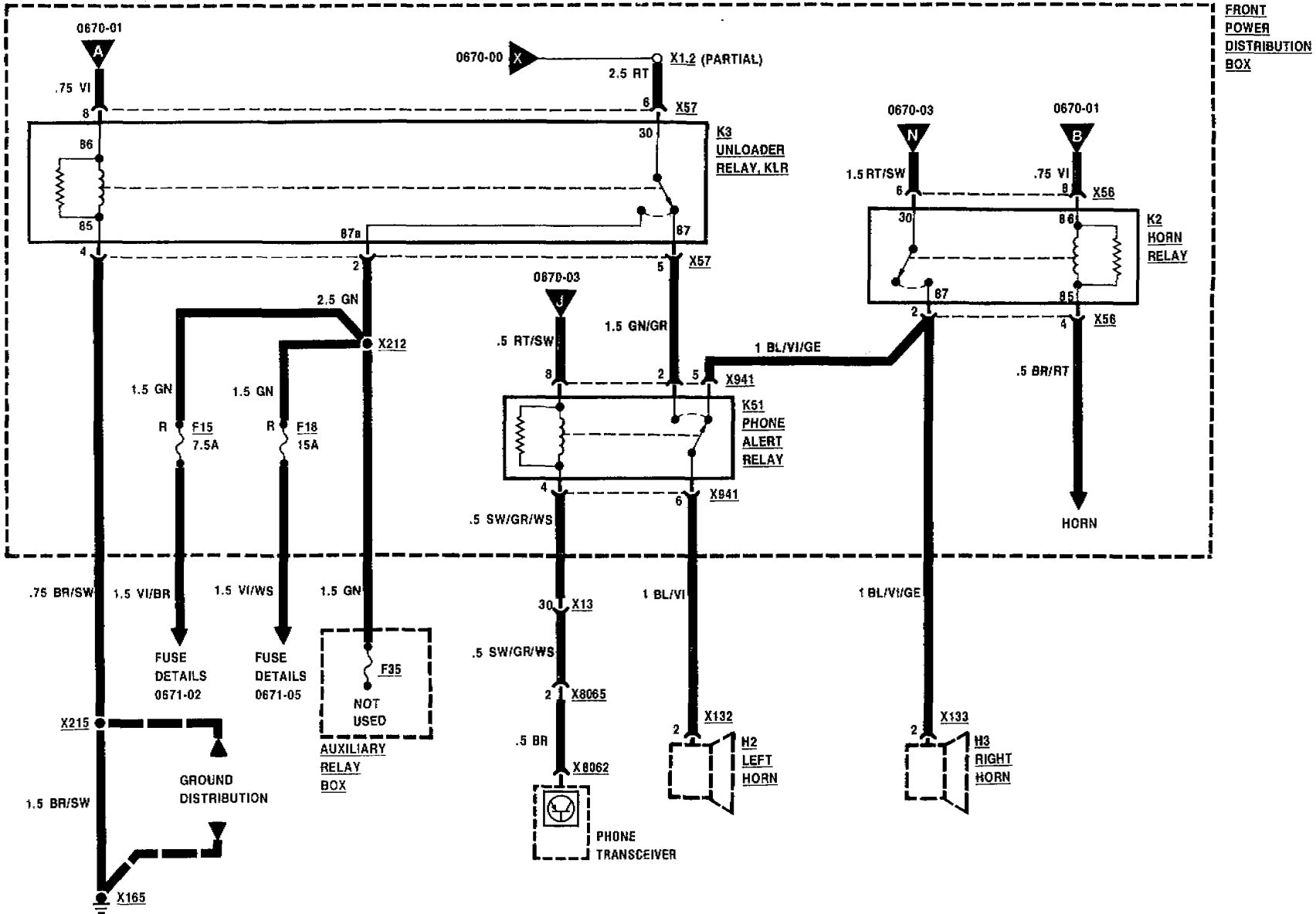

FRONT
POWER
DISTRIBUTION
BOX



POWER DISTRIBUTION

FRONT POWER DISTRIBUTION BOX

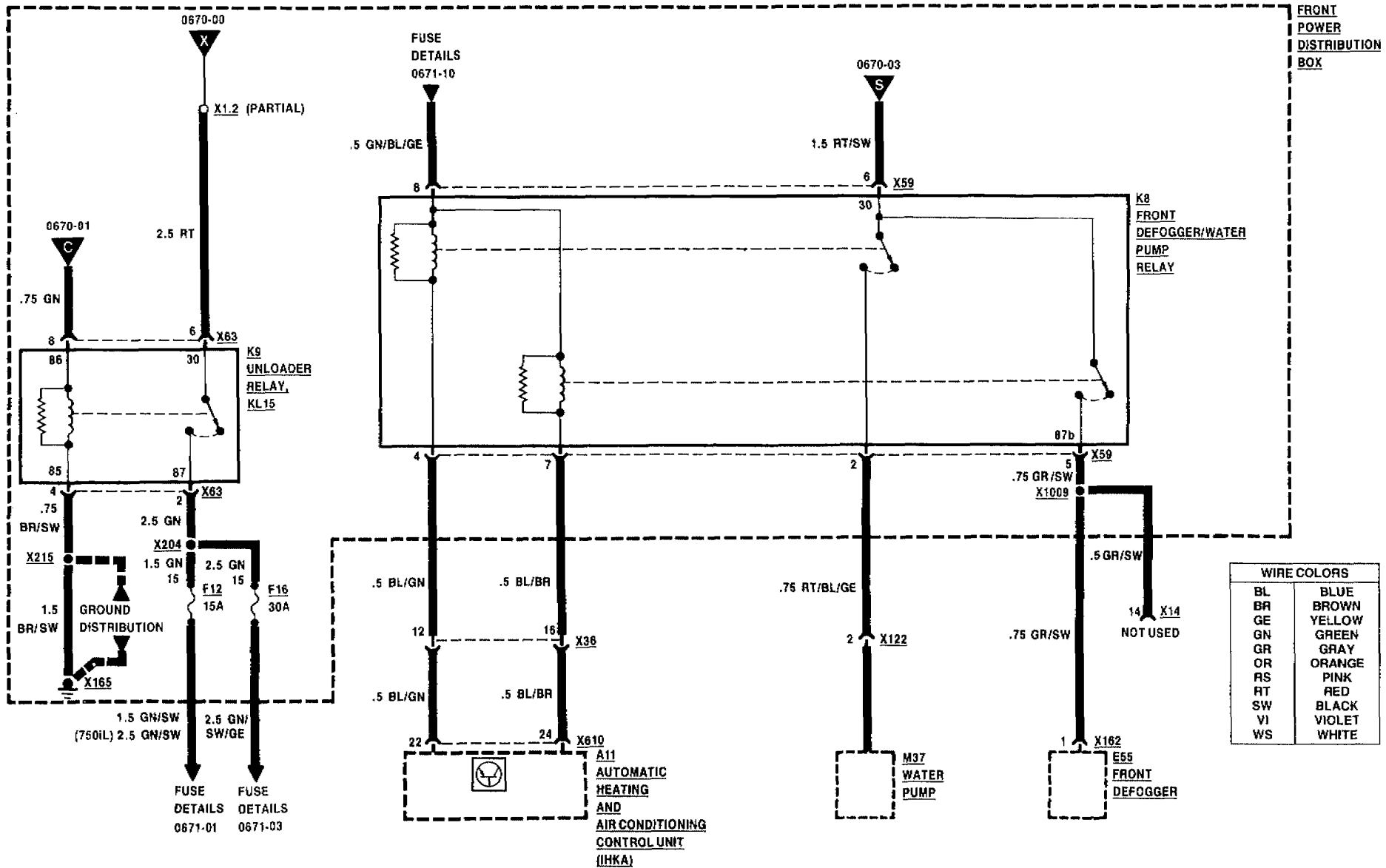

WIRE COLORS	
BL	BLUE
BR	BROWN
GE	YELLOW
GN	GREEN
GR	GRAY
OR	ORANGE
RS	PINK
RT	RED
SW	BLACK
VI	VIOLET
WS	WHITE



POWER DISTRIBUTION

REAR POWER DISTRIBUTION BOX

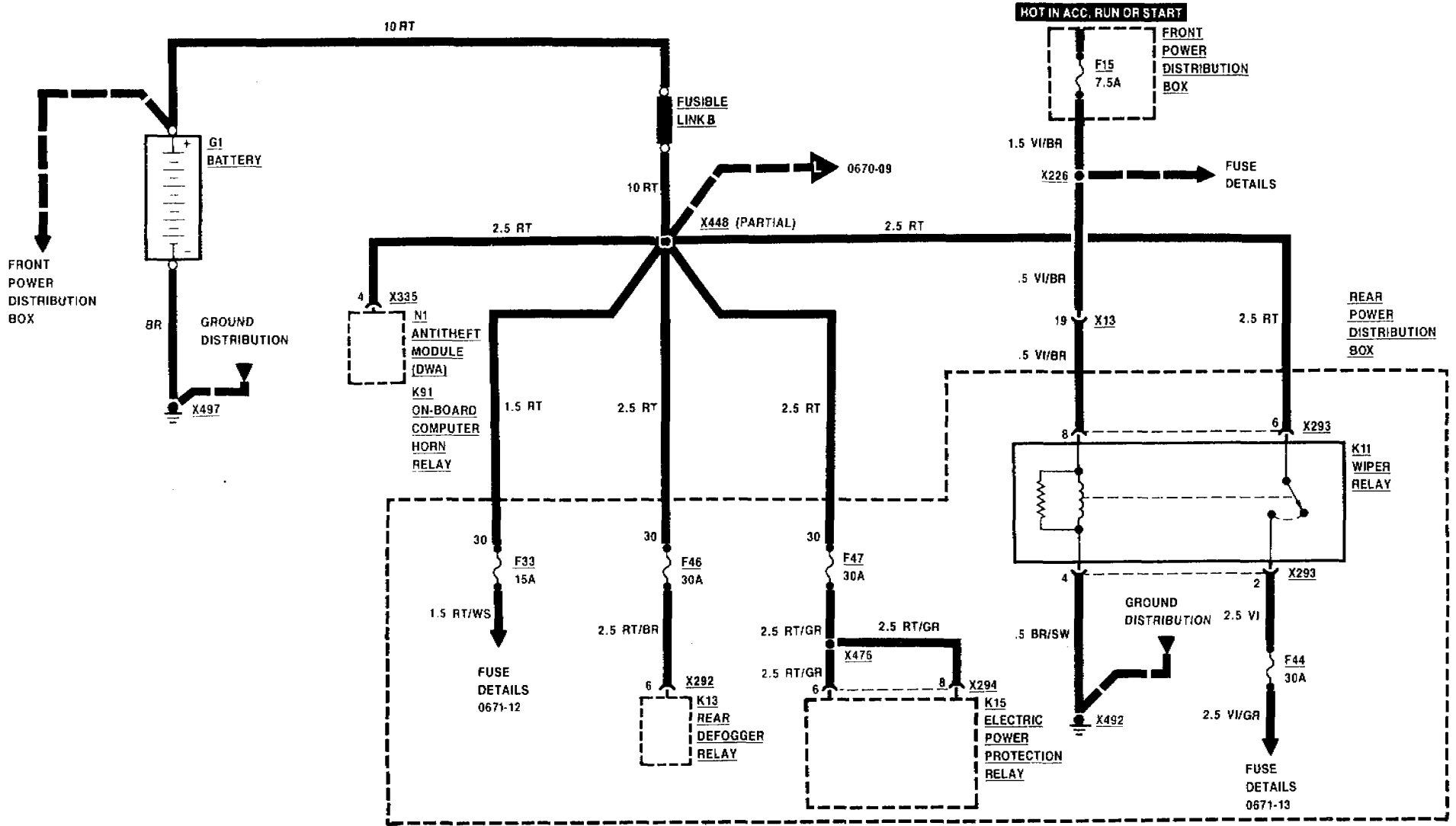



POWER DISTRIBUTION

REAR POWER DISTRIBUTION BOX

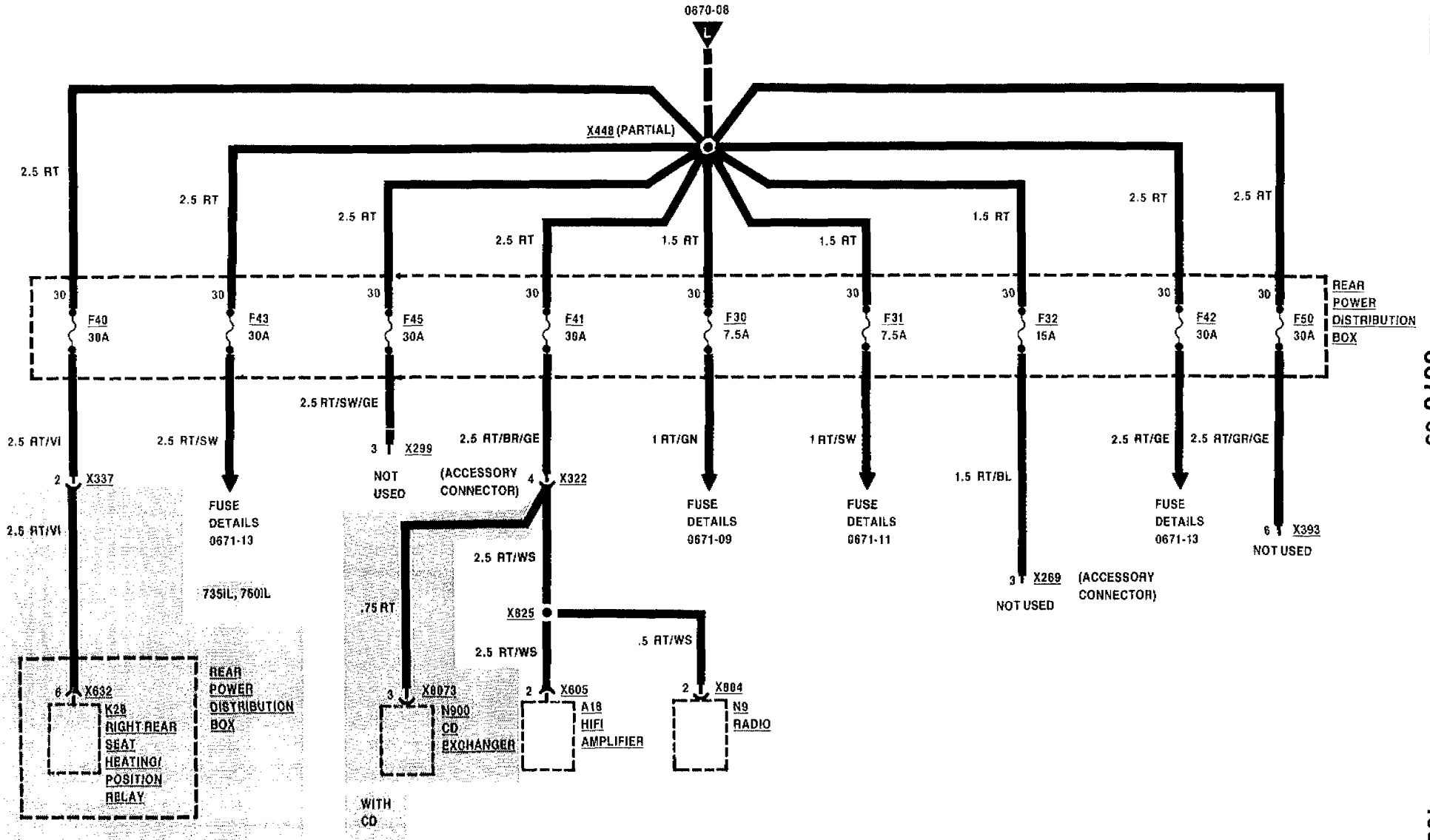



FUSE DETAILS

FUSE 1

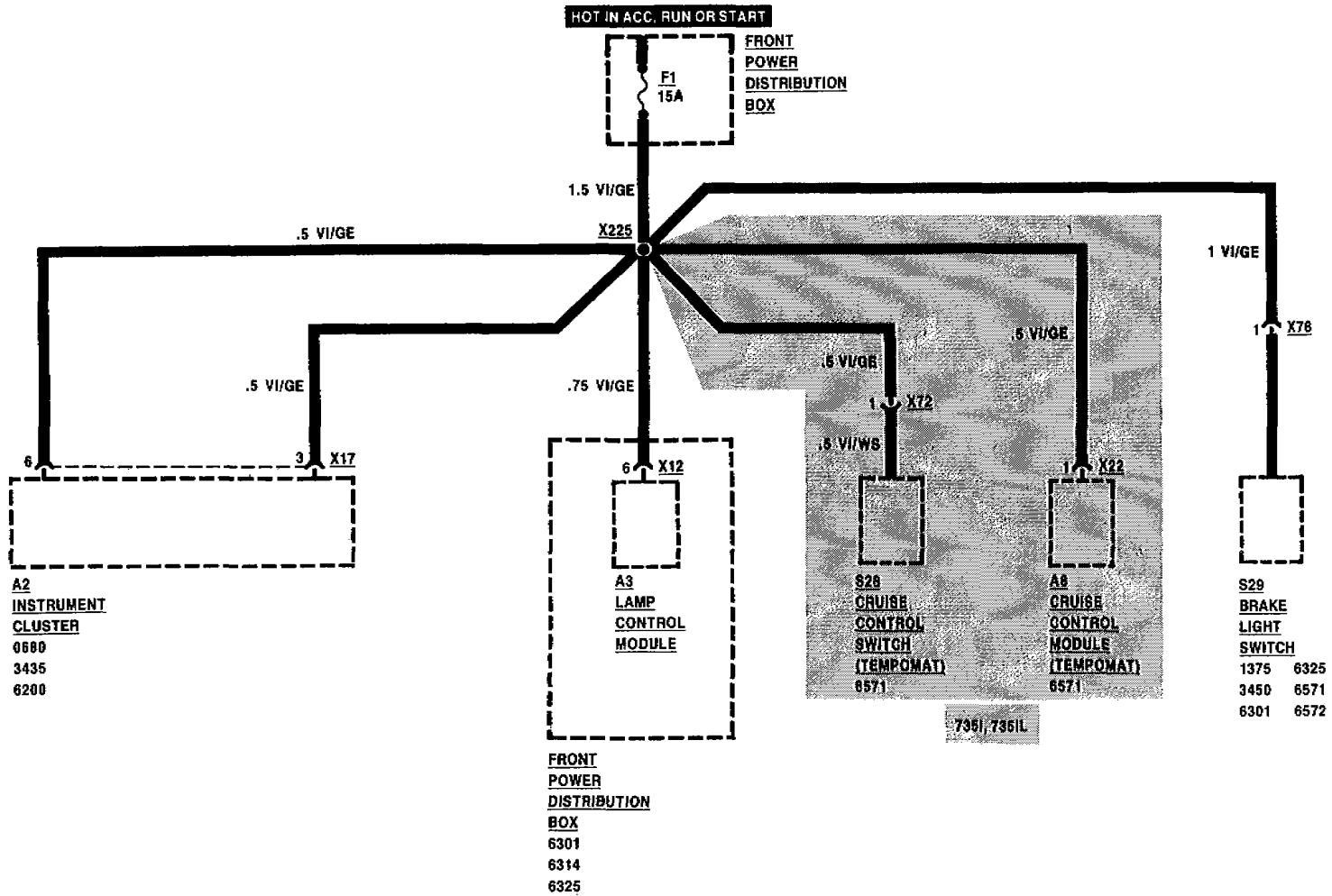



FUSE DETAILS

FUSE 12

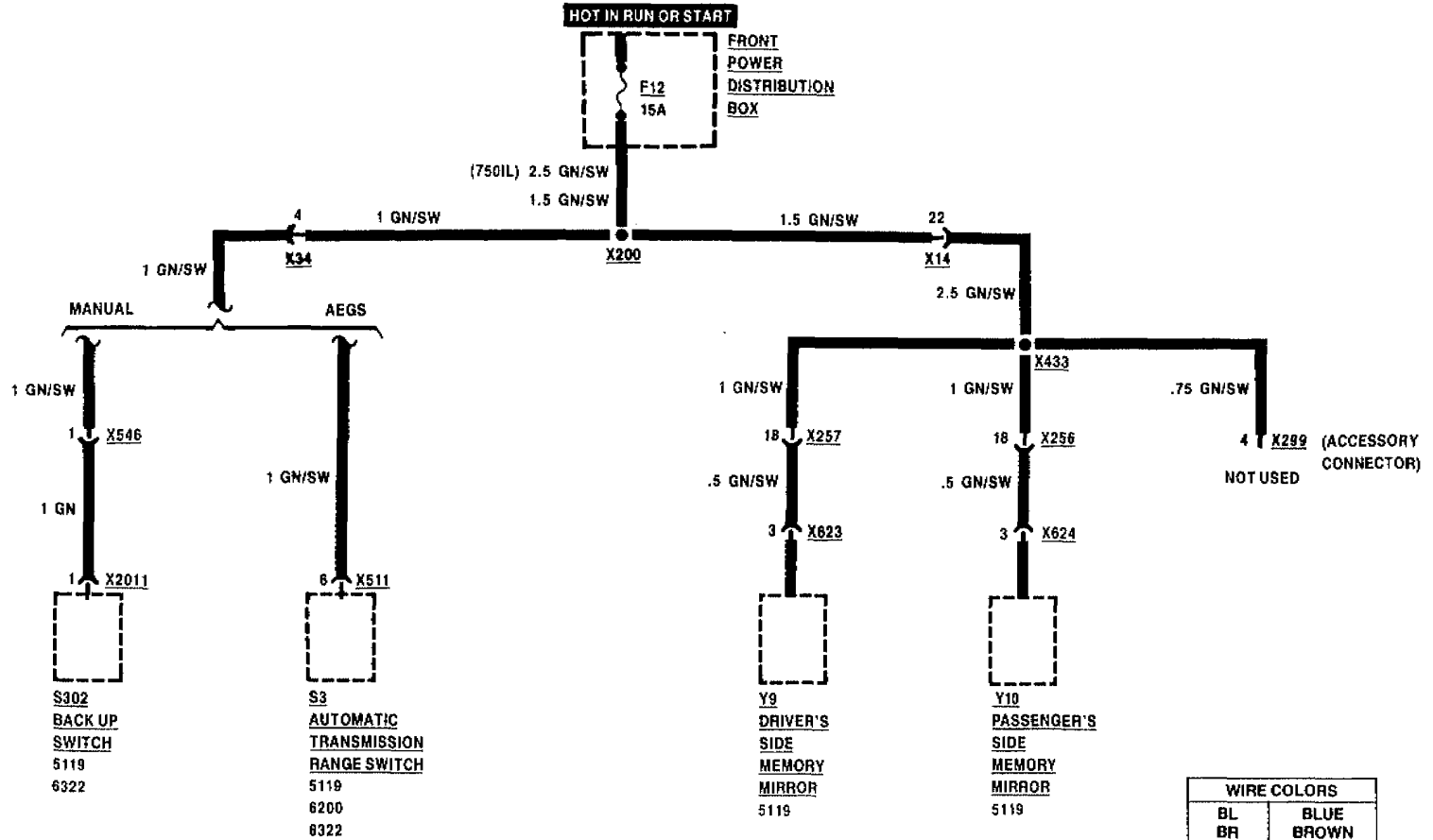

WIRE COLORS	
BL	BLUE
BR	BROWN
GE	YELLOW
GN	GREEN
GR	GRAY
OR	ORANGE
RS	PINK
RT	RED
SW	BLACK
VI	VIOLET
WS	WHITE



FUSE DETAILS

FUSE 15

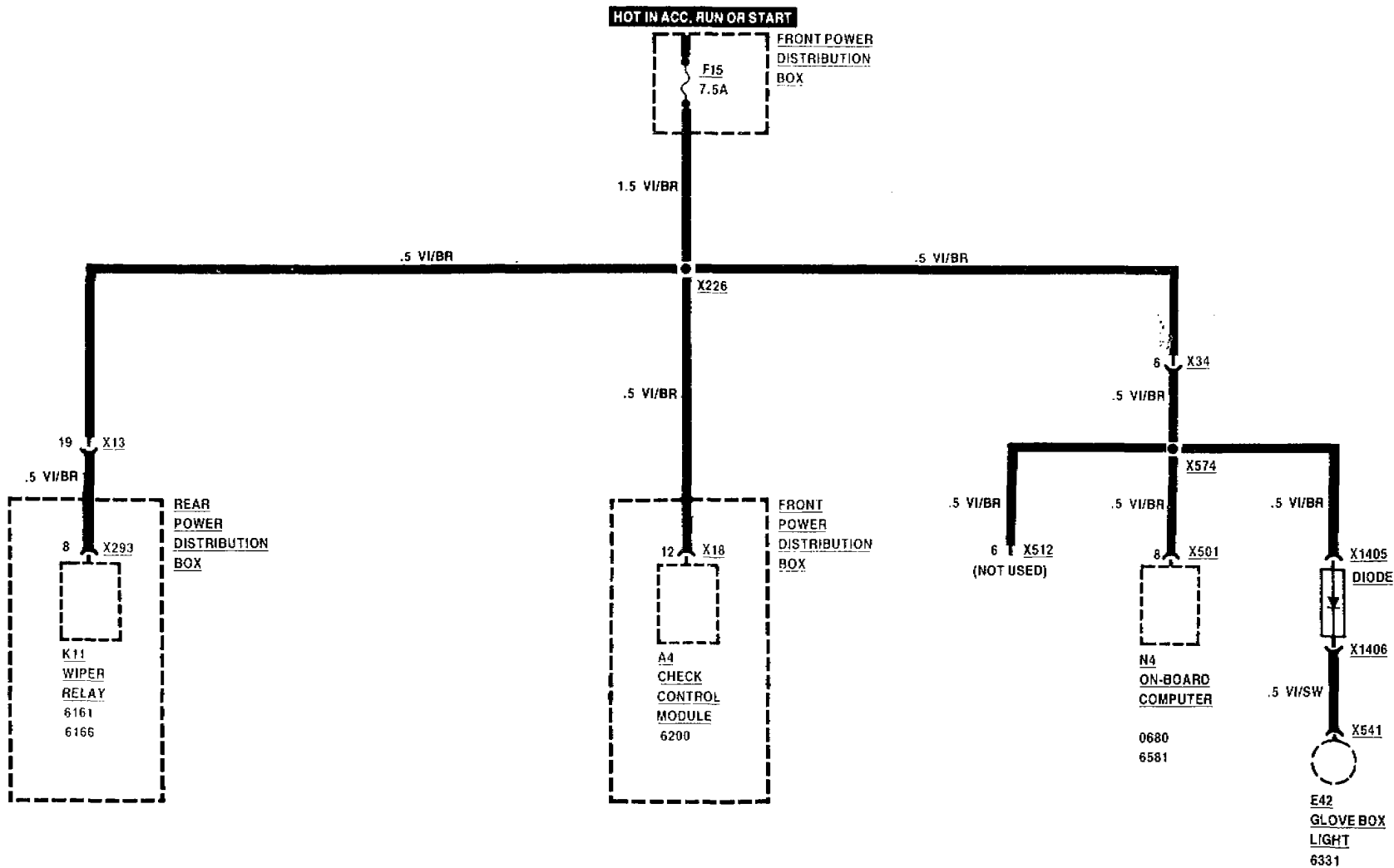



FUSE DETAILS

FUSE 16

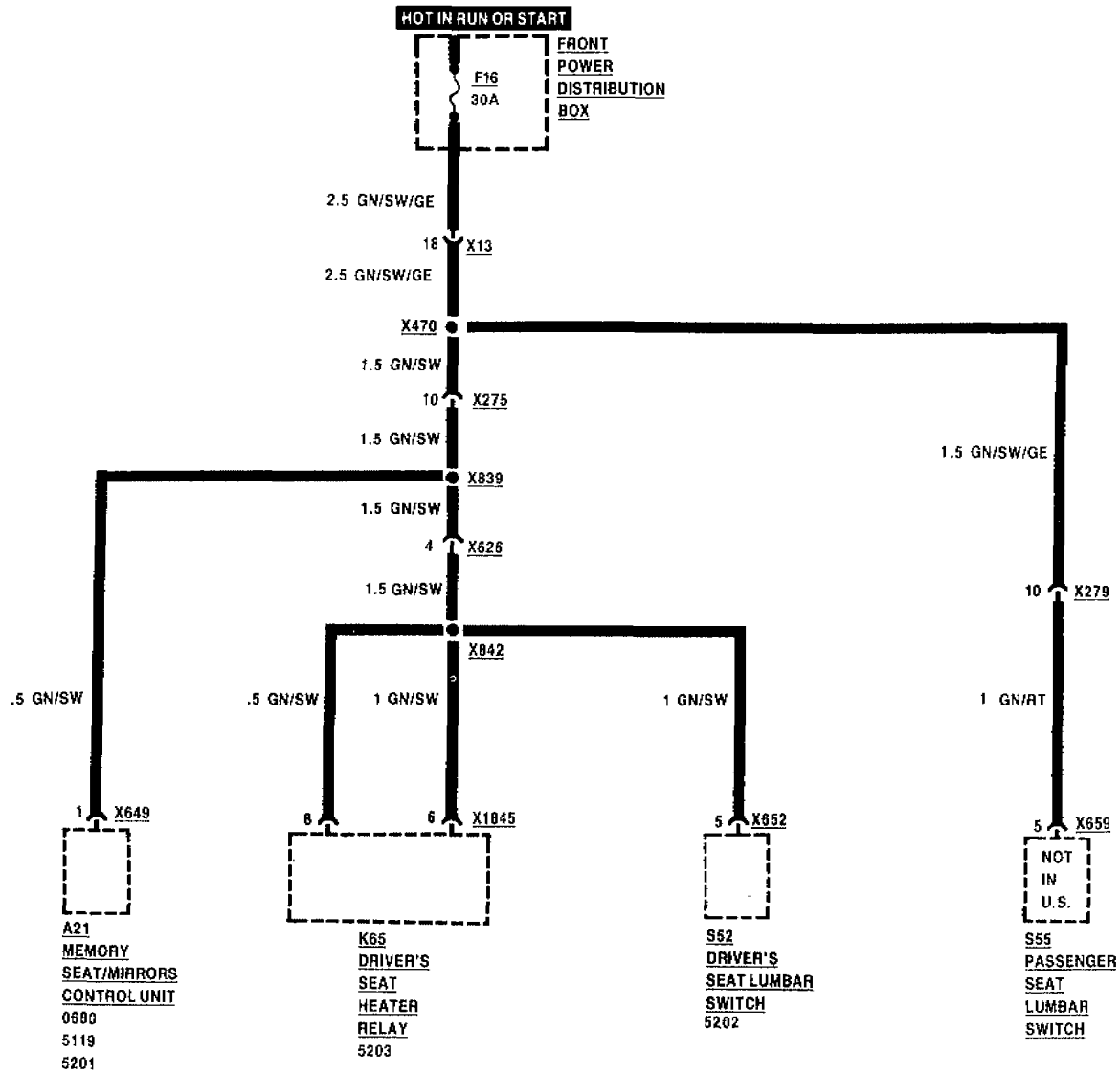



FUSE DETAILS

FUSE 17

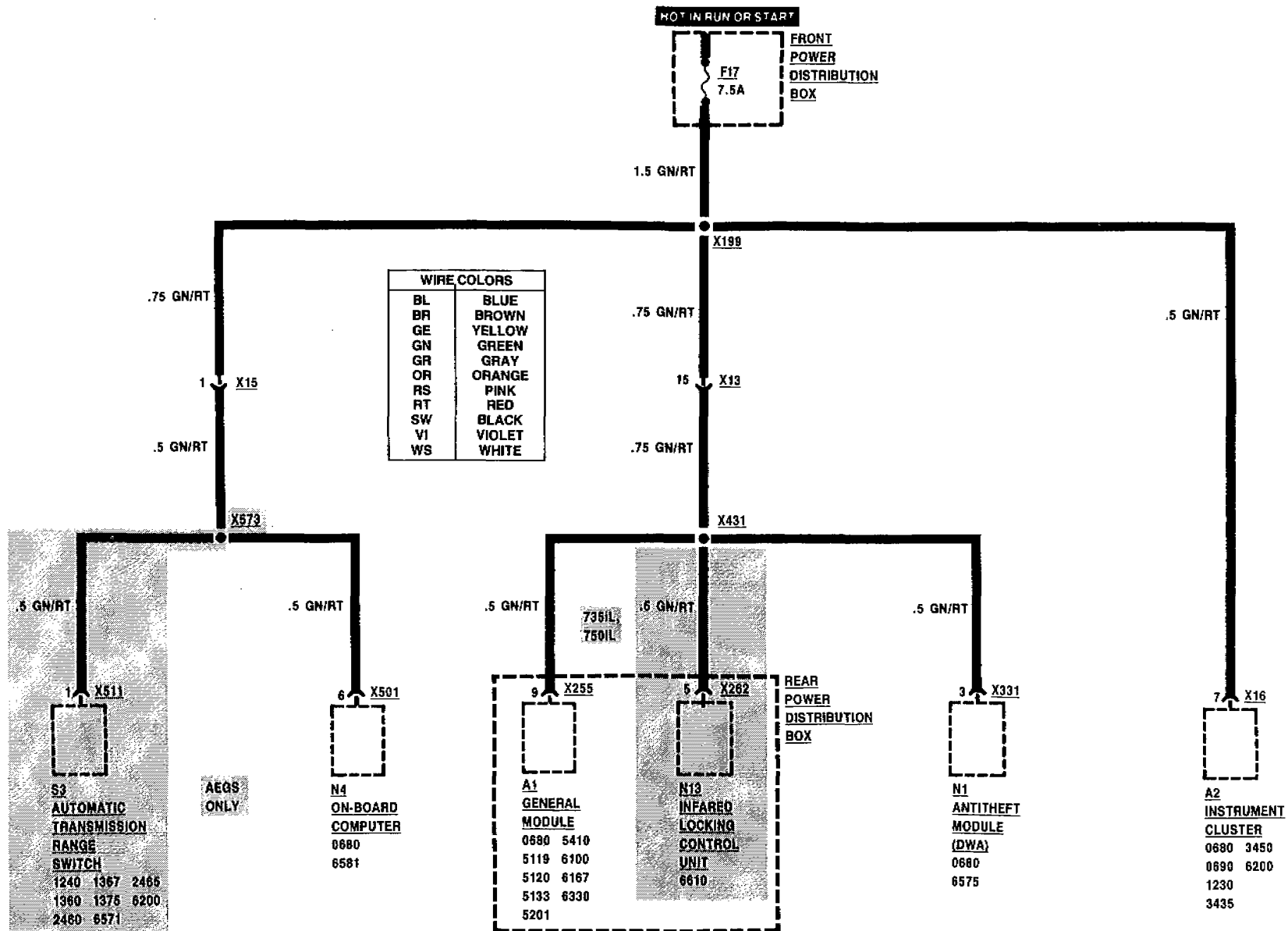



FUSE DETAILS

FUSE 18

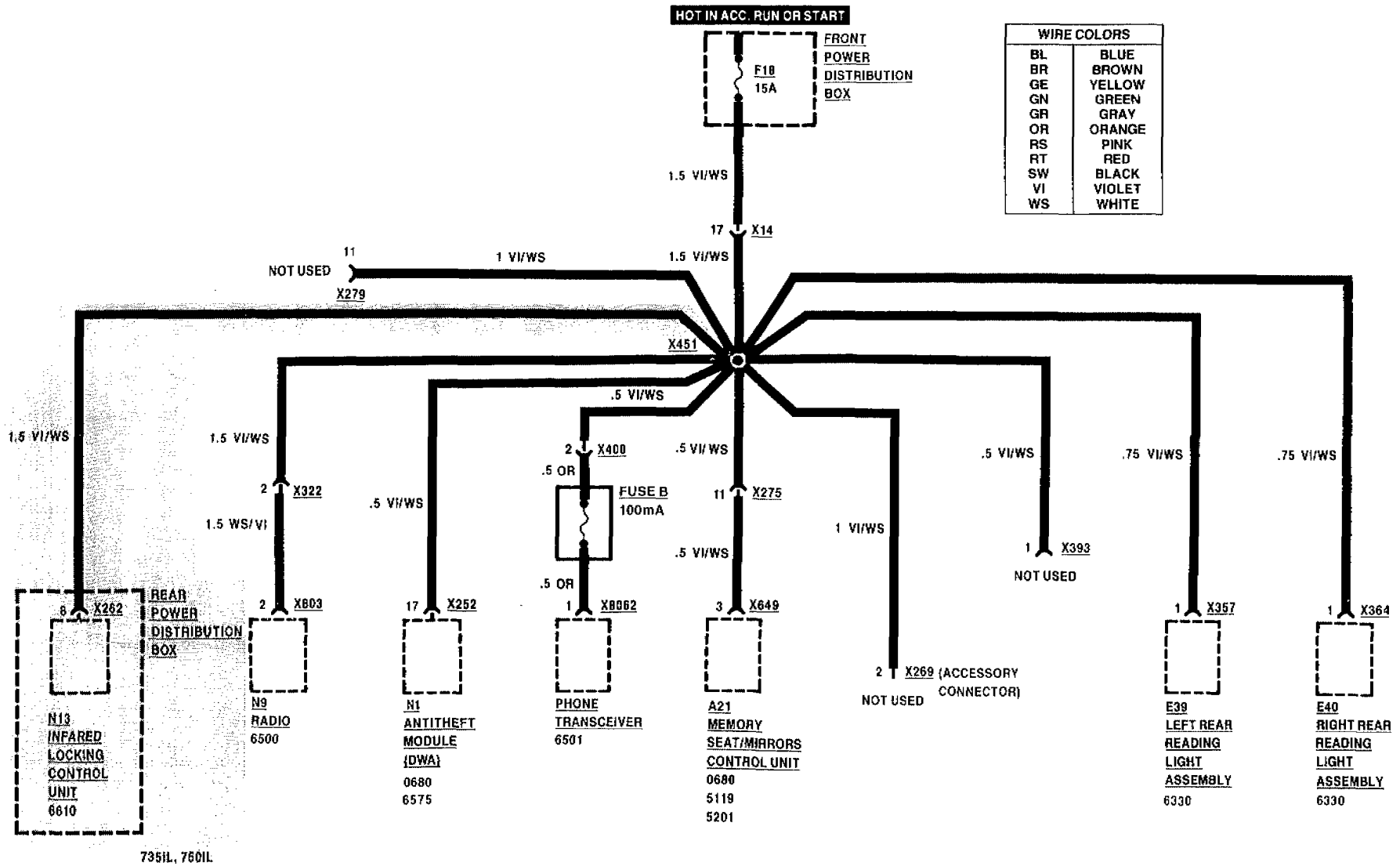



FUSE DETAILS

FUSE 21

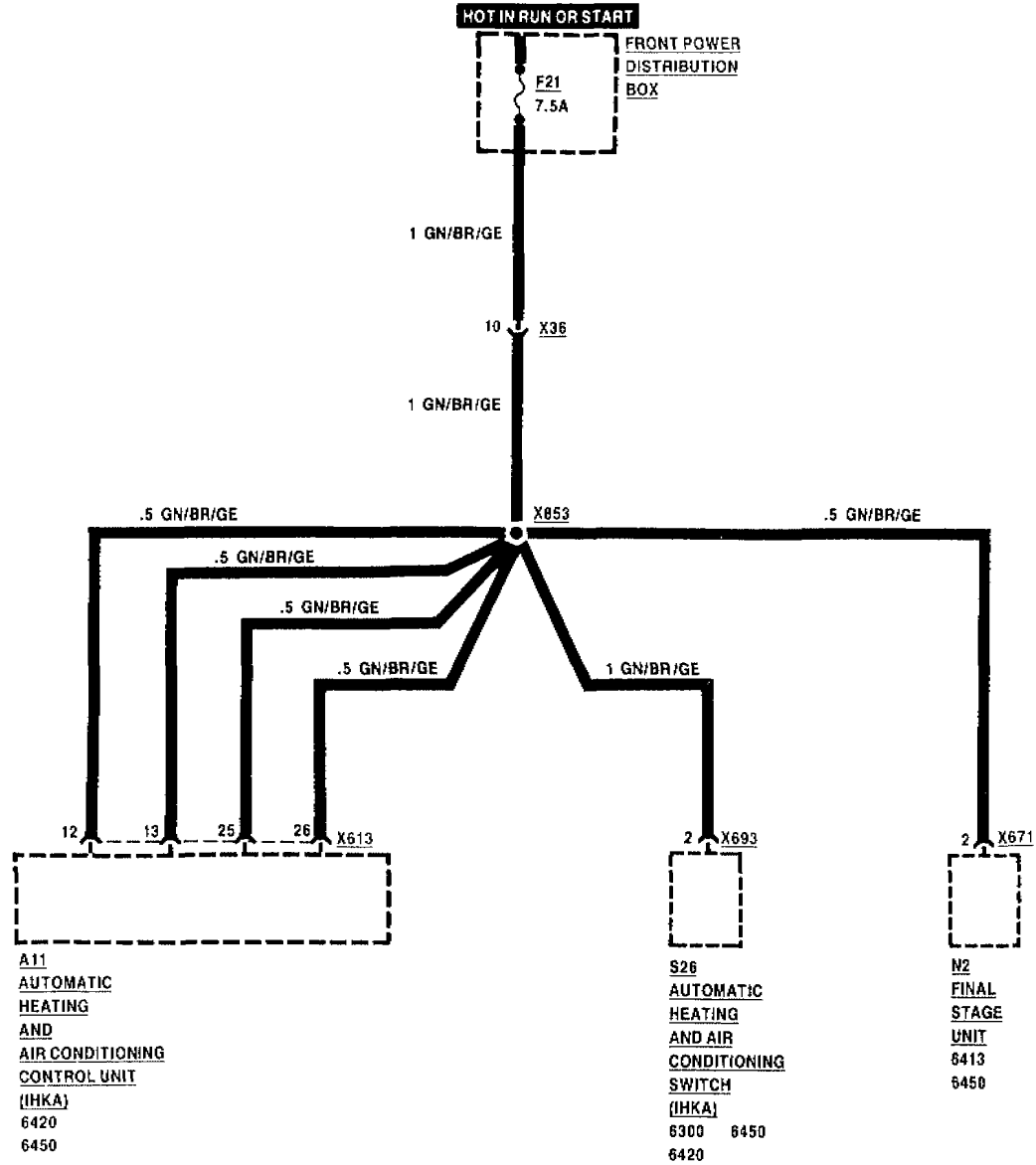

BMW
7 **FUSE DETAILS**
FUSE 22

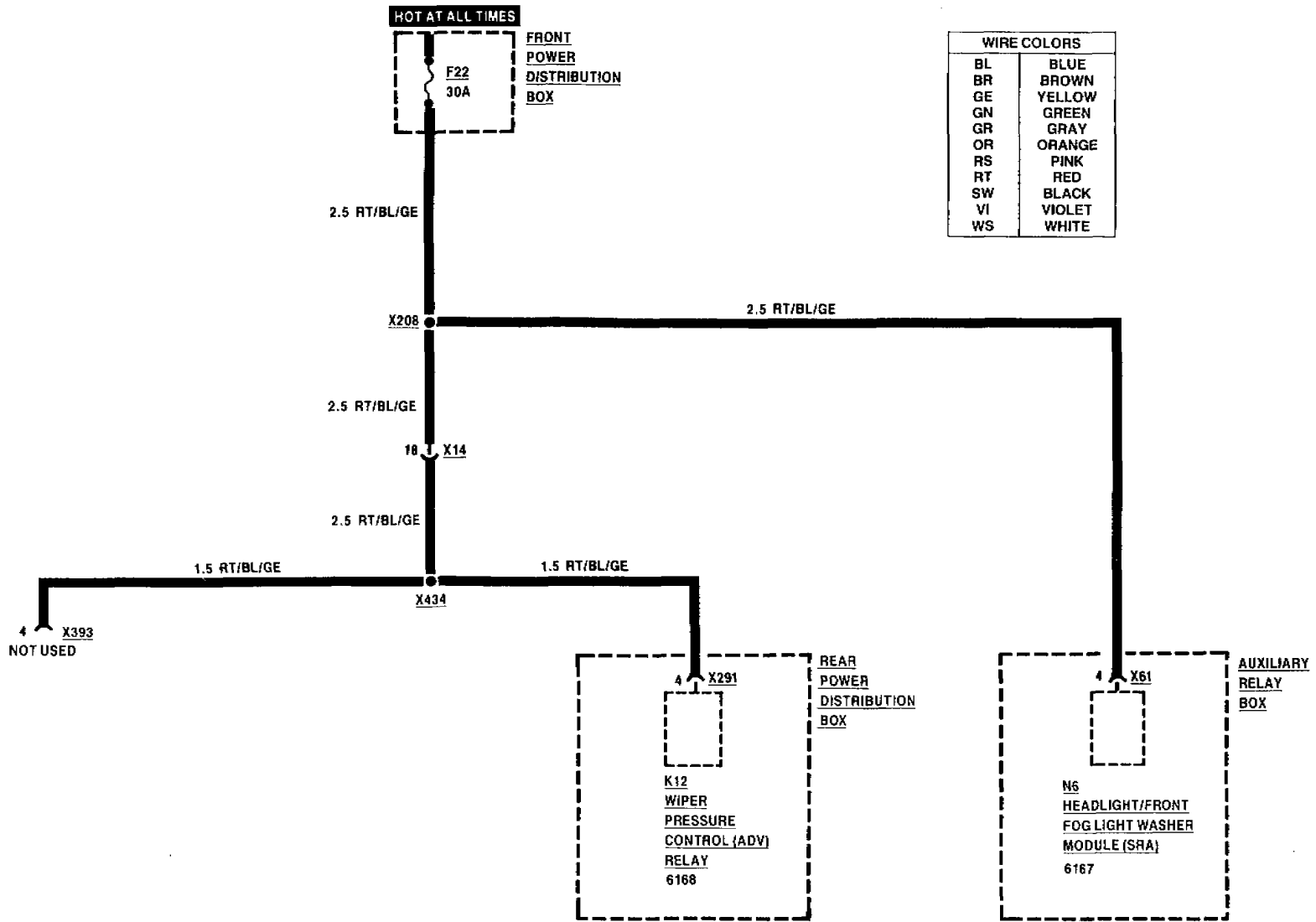

WIRE COLORS	
BL	BLUE
BR	BROWN
GE	YELLOW
GN	GREEN
GR	GRAY
OR	ORANGE
RS	PINK
RT	RED
SW	BLACK
VI	VIOLET
WS	WHITE

09/88 — 0671-08 — 1989

BMW
7 **FUSE DETAILS**
FUSE 29

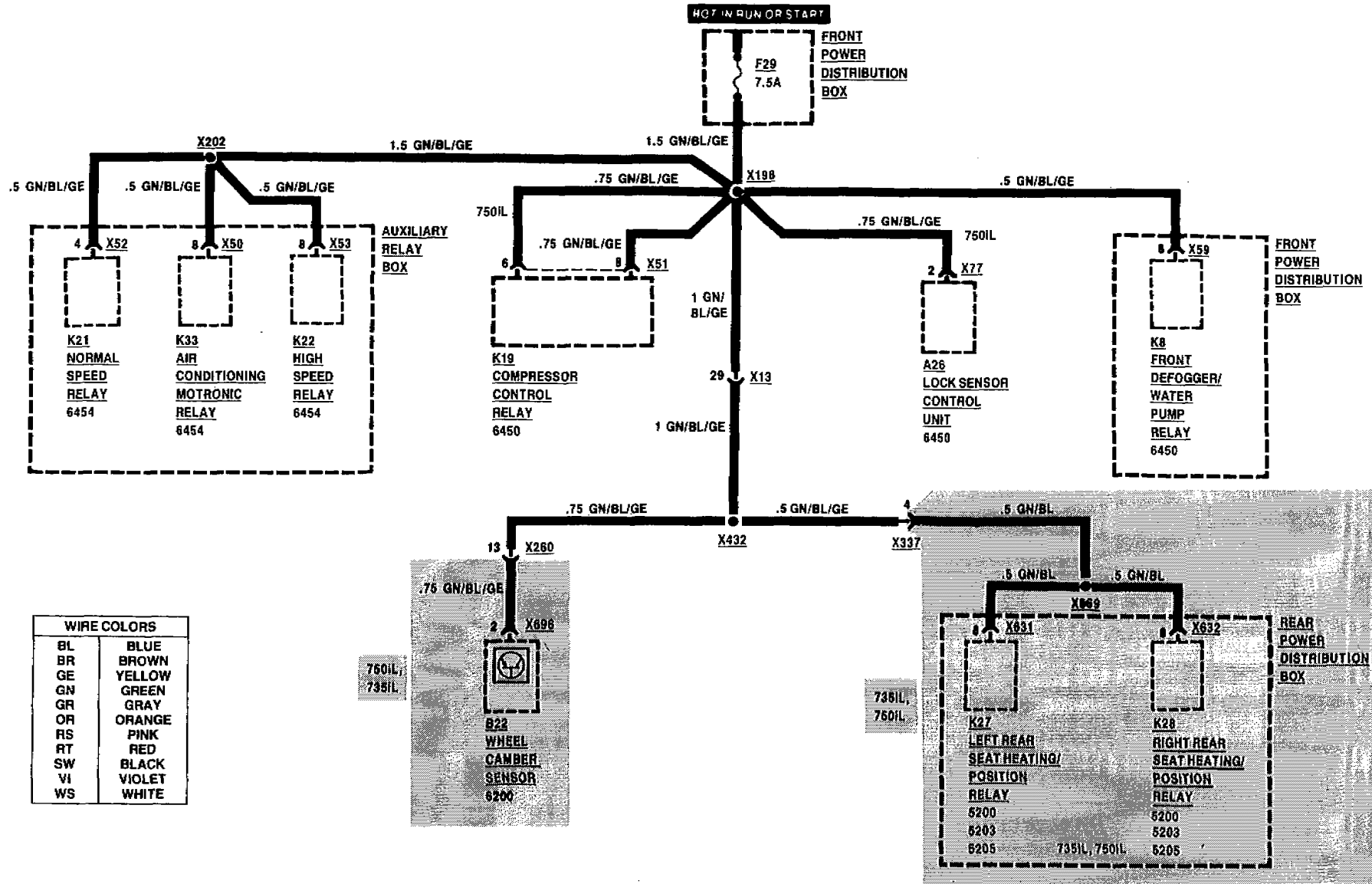

WIRE COLORS	
BL	BLUE
BR	BROWN
GE	YELLOW
GN	GREEN
GR	GRAY
OR	ORANGE
RS	PINK
RT	RED
SW	BLACK
VI	VIOLET
WS	WHITE



FUSE DETAILS

FUSE 31

HOT AT ALL TIMES

REAR
POWER
DISTRIBUTION
BOX

WIRE COLORS	
BL	BLUE
BR	BROWN
GE	YELLOW
GN	GREEN
GR	GRAY
OR	ORANGE
RS	PINK
RT	RED
SW	BLACK
VI	VIOLET
WS	WHITE

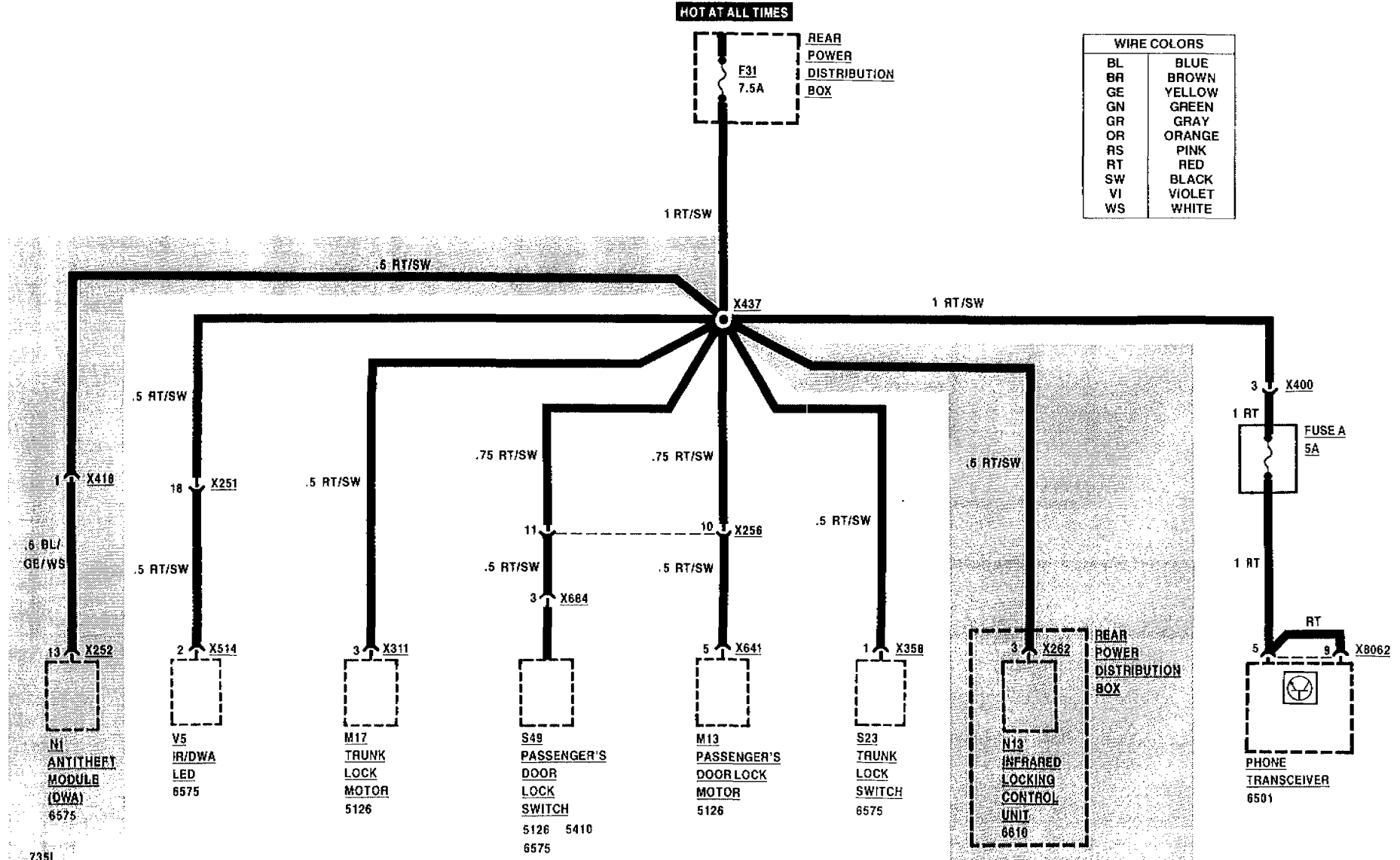

7351

7361L, 7801L



FUSE DETAILS

FUSE 33

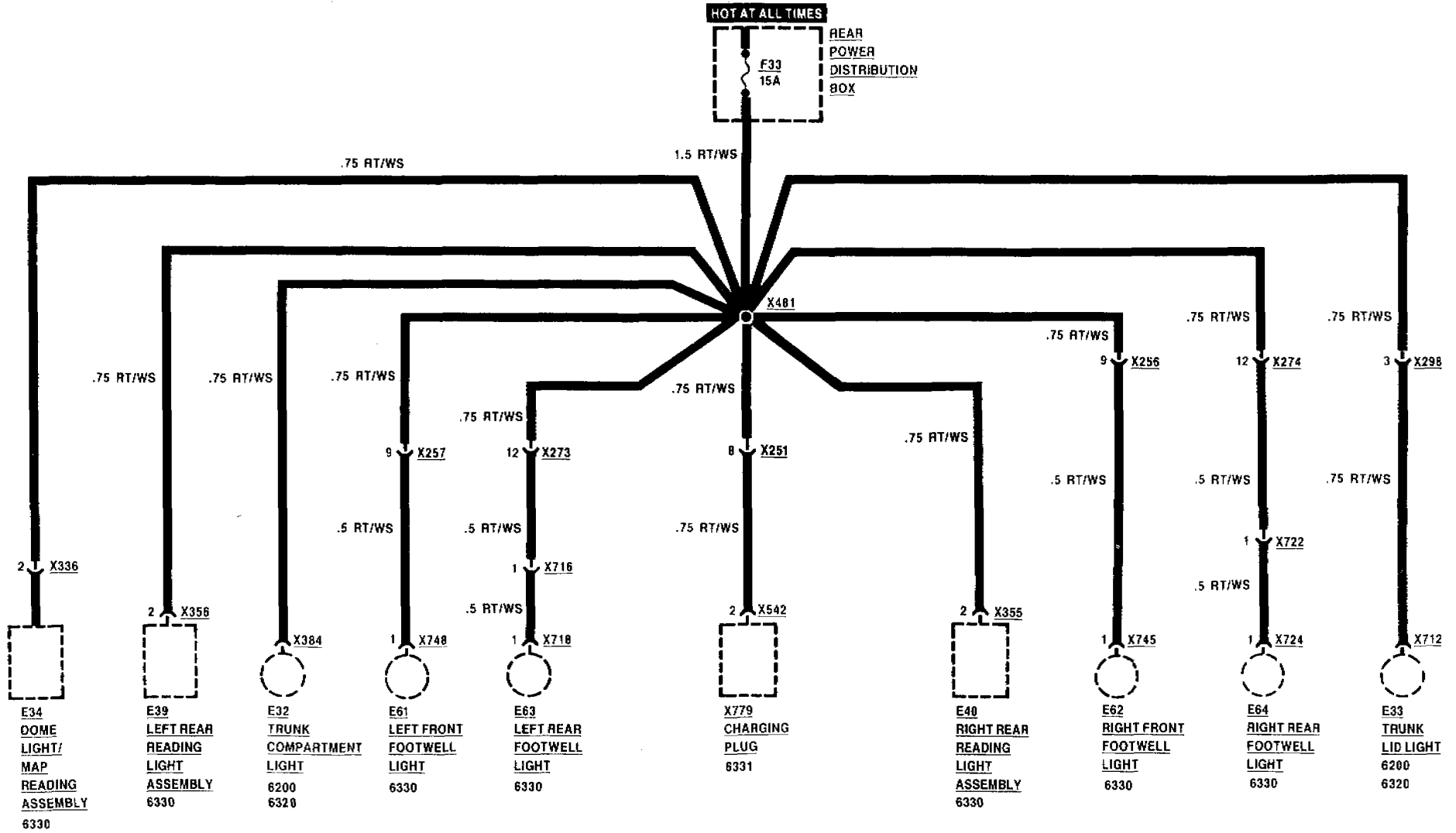



FUSE DETAILS

FUSES 42, 43, AND 44

WIRE COLORS	
BL	BLUE
BR	BROWN
GE	YELLOW
GN	GREEN
GR	GRAY
OR	ORANGE
RS	PINK
RT	RED
SW	BLACK
VI	VIOLET
WS	WHITE

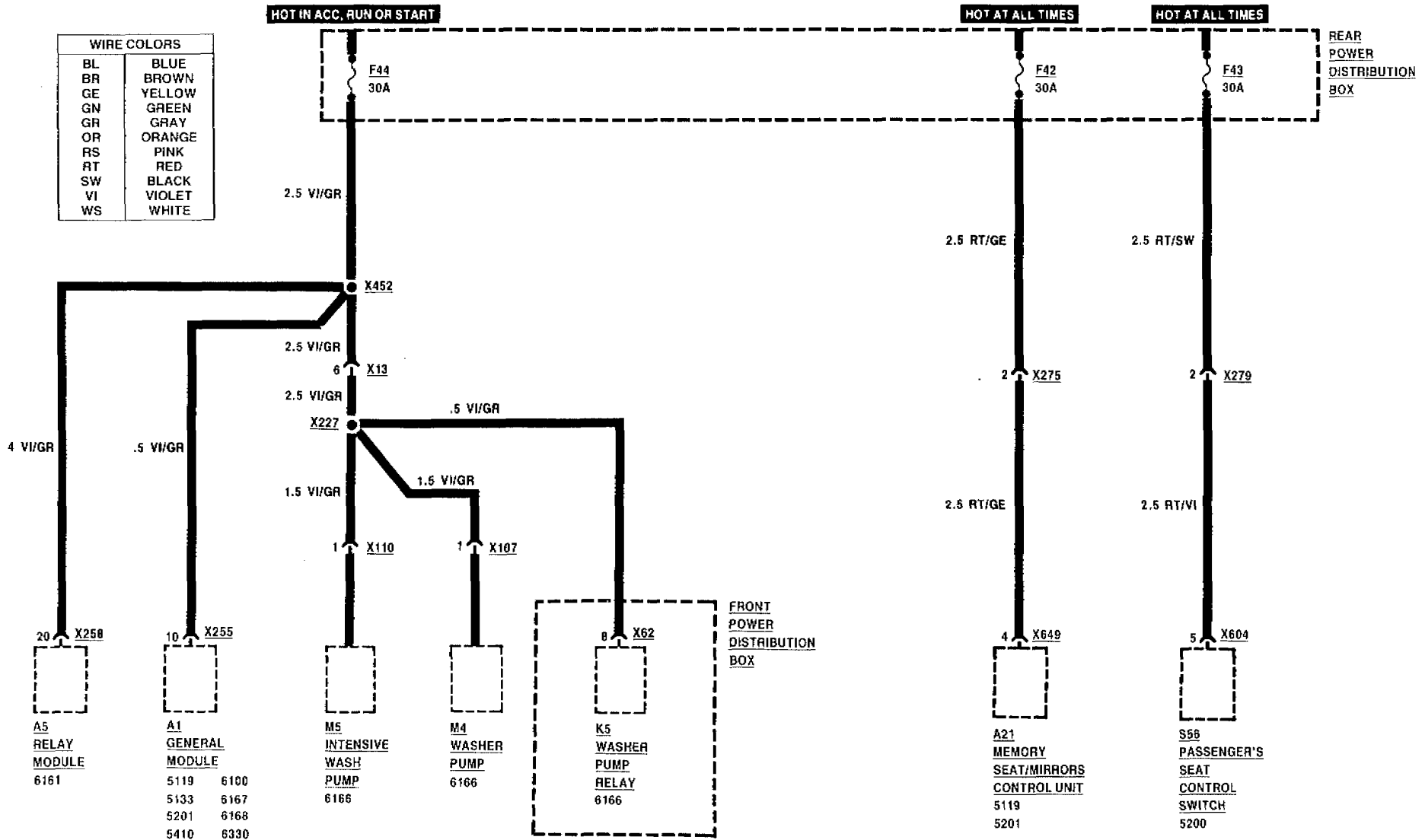



GROUND DISTRIBUTION GROUND X165

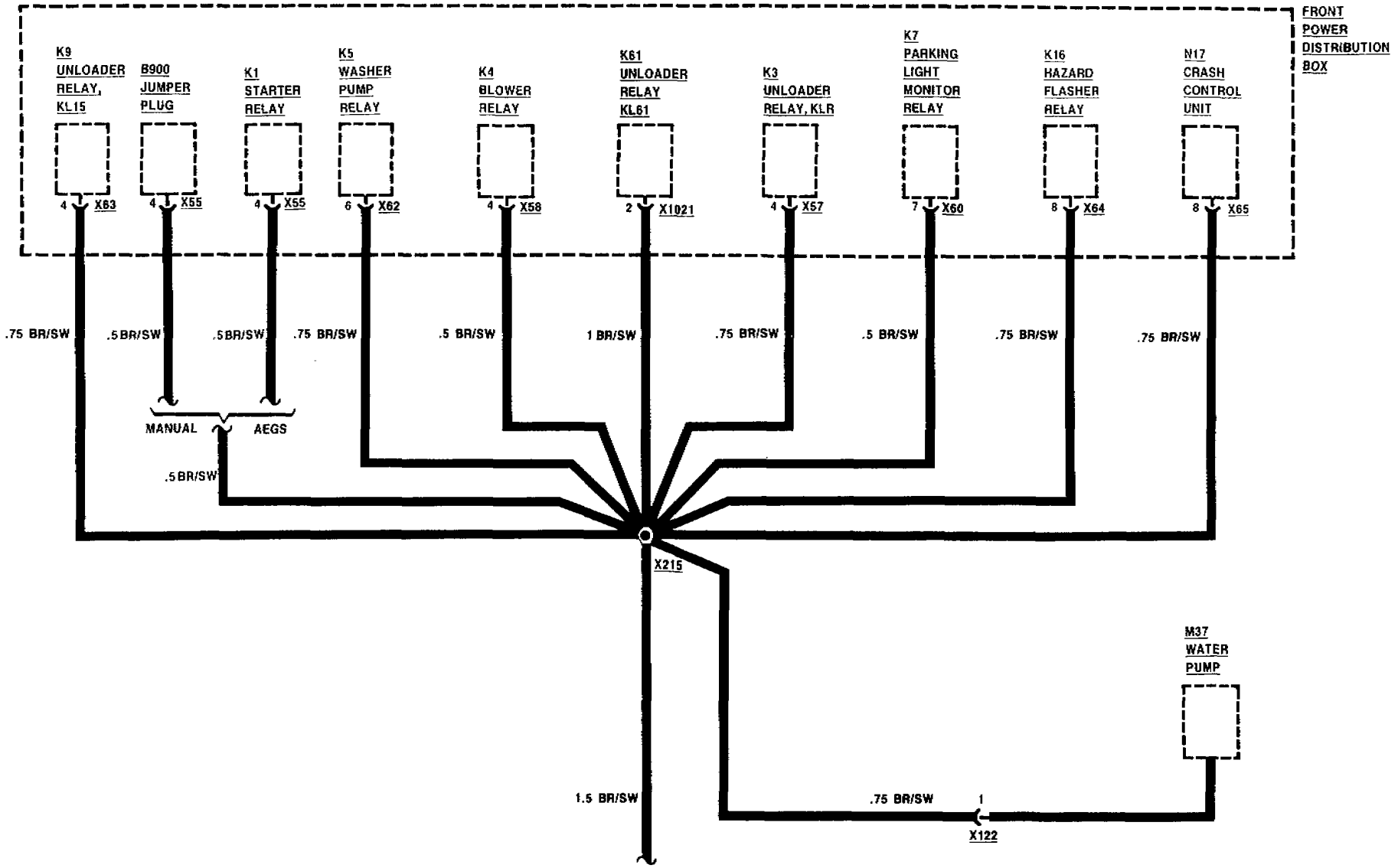

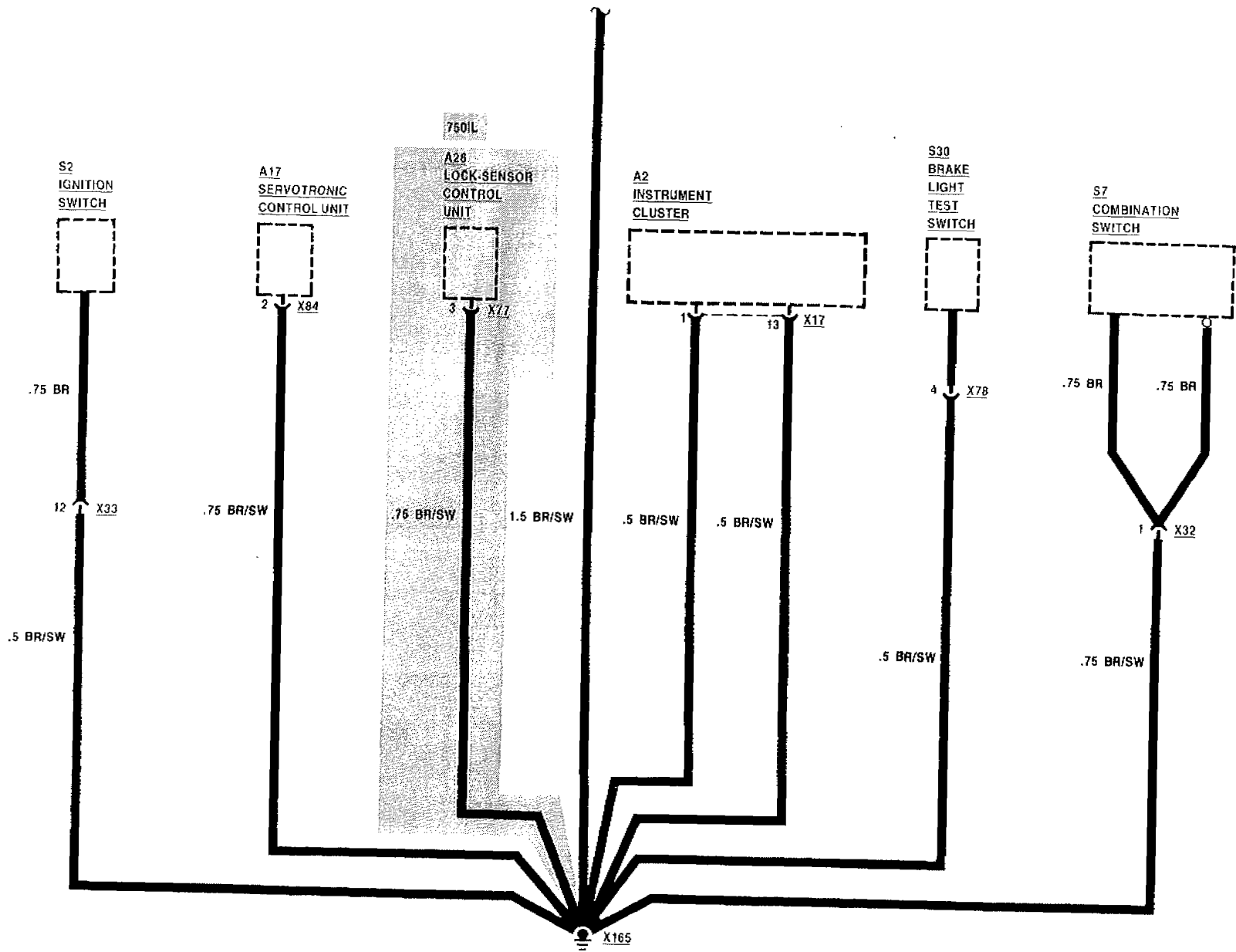



GROUND DISTRIBUTION

750iL

GROUND X166

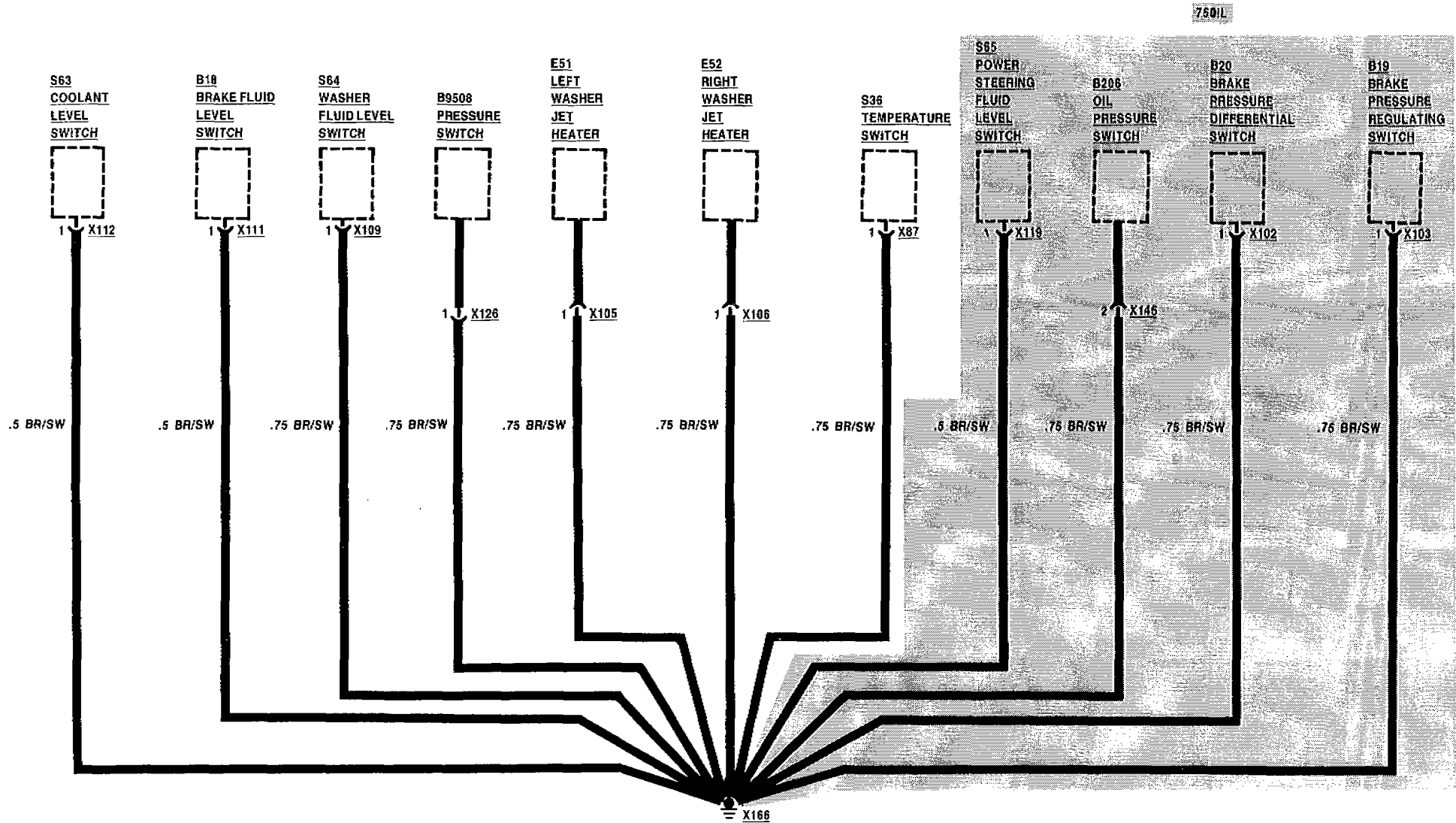

750iL

11/89

0672-02

1989



GROUND DISTRIBUTION

GROUND X167

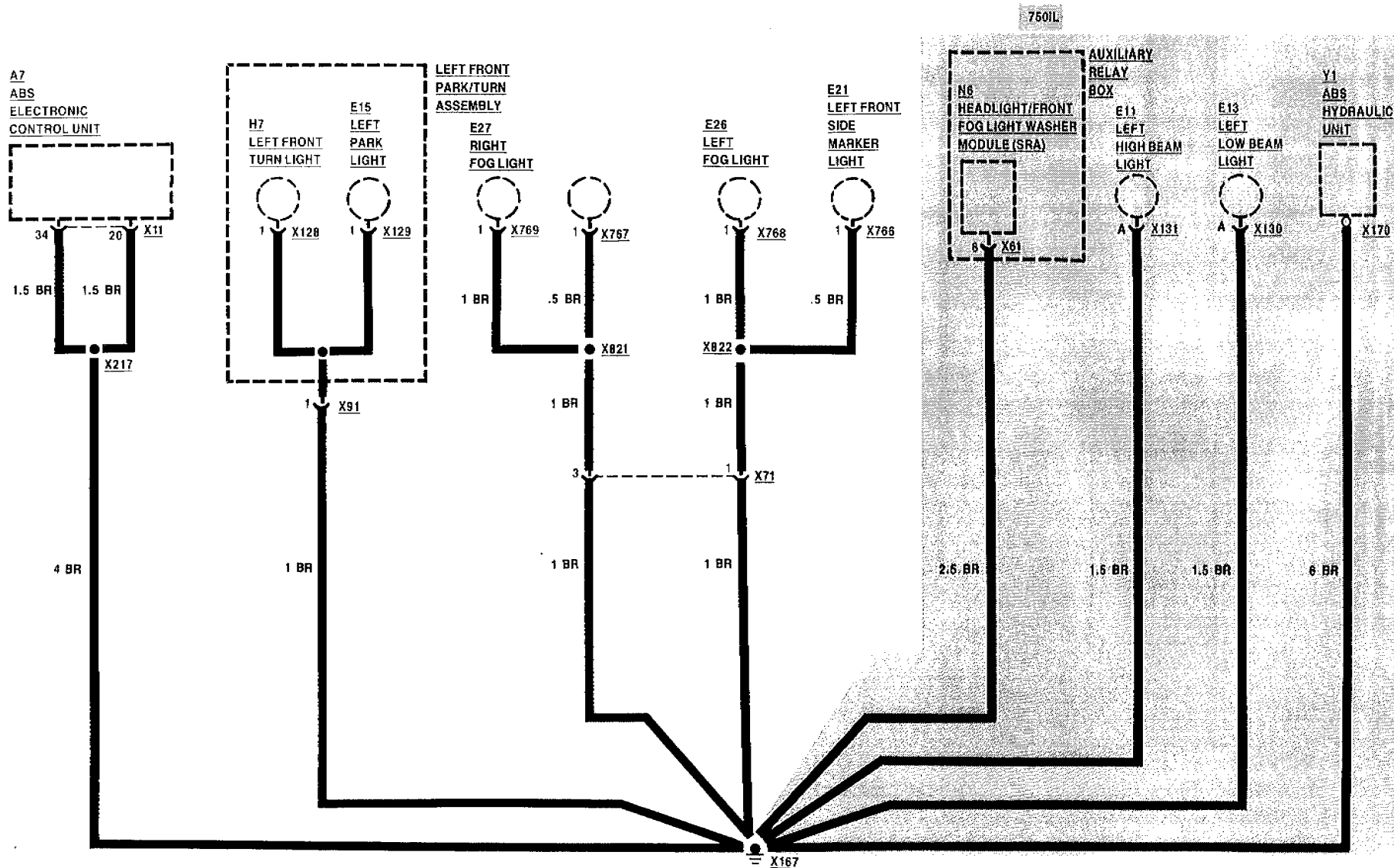



GROUND DISTRIBUTION

GROUND X172

735i, 735iL

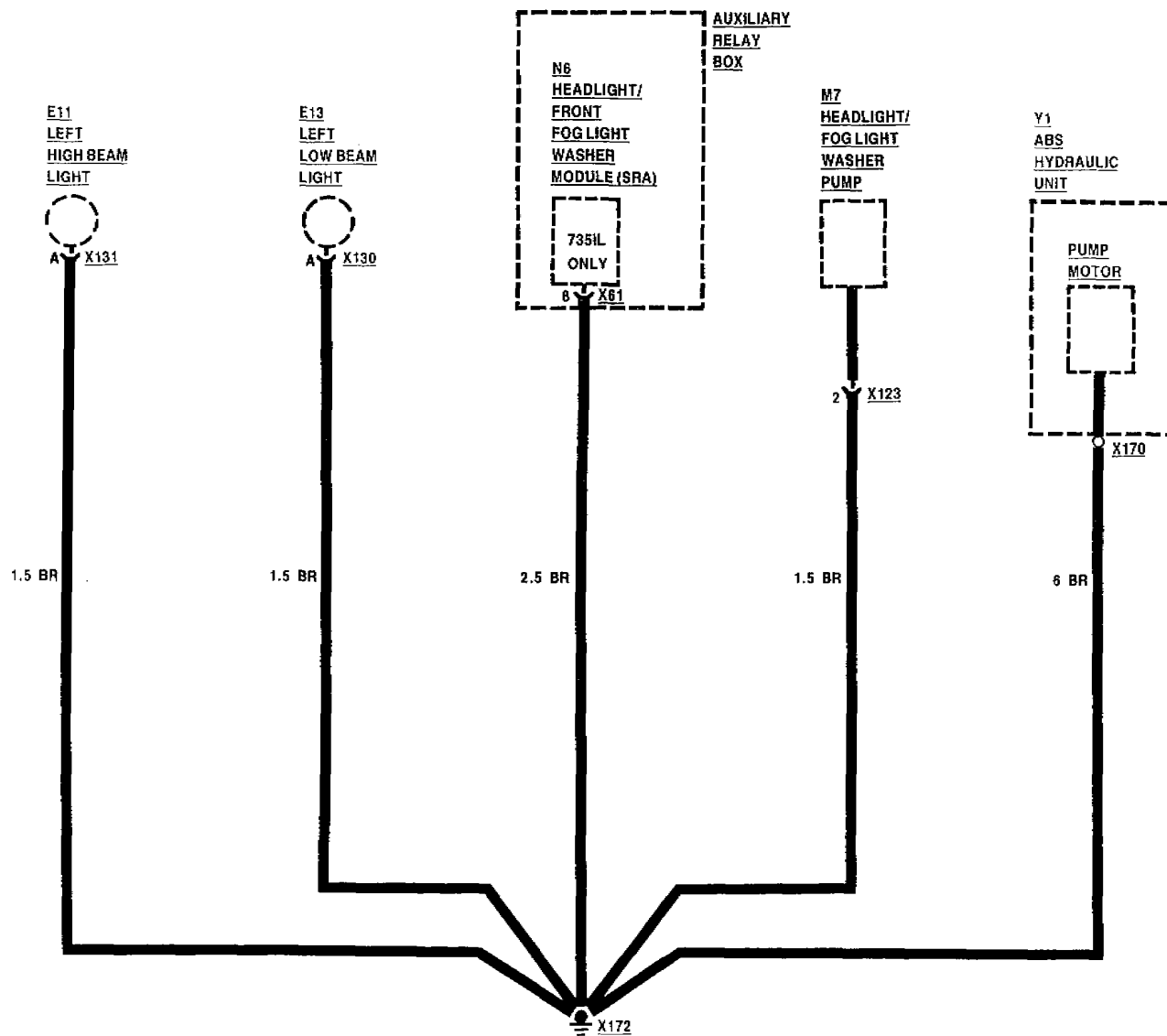



GROUND DISTRIBUTION

GROUND X173

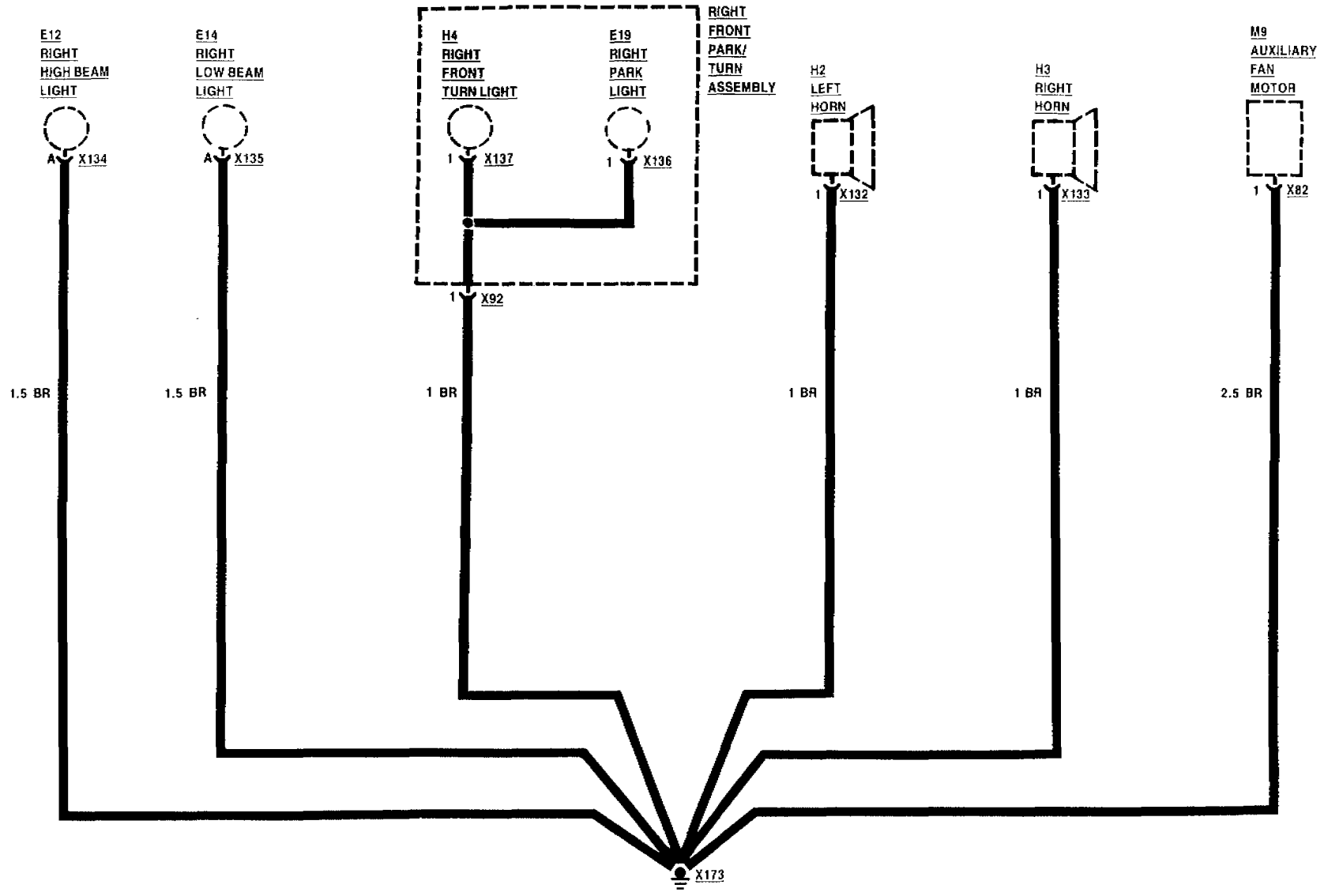



GROUND DISTRIBUTION

GROUND X490

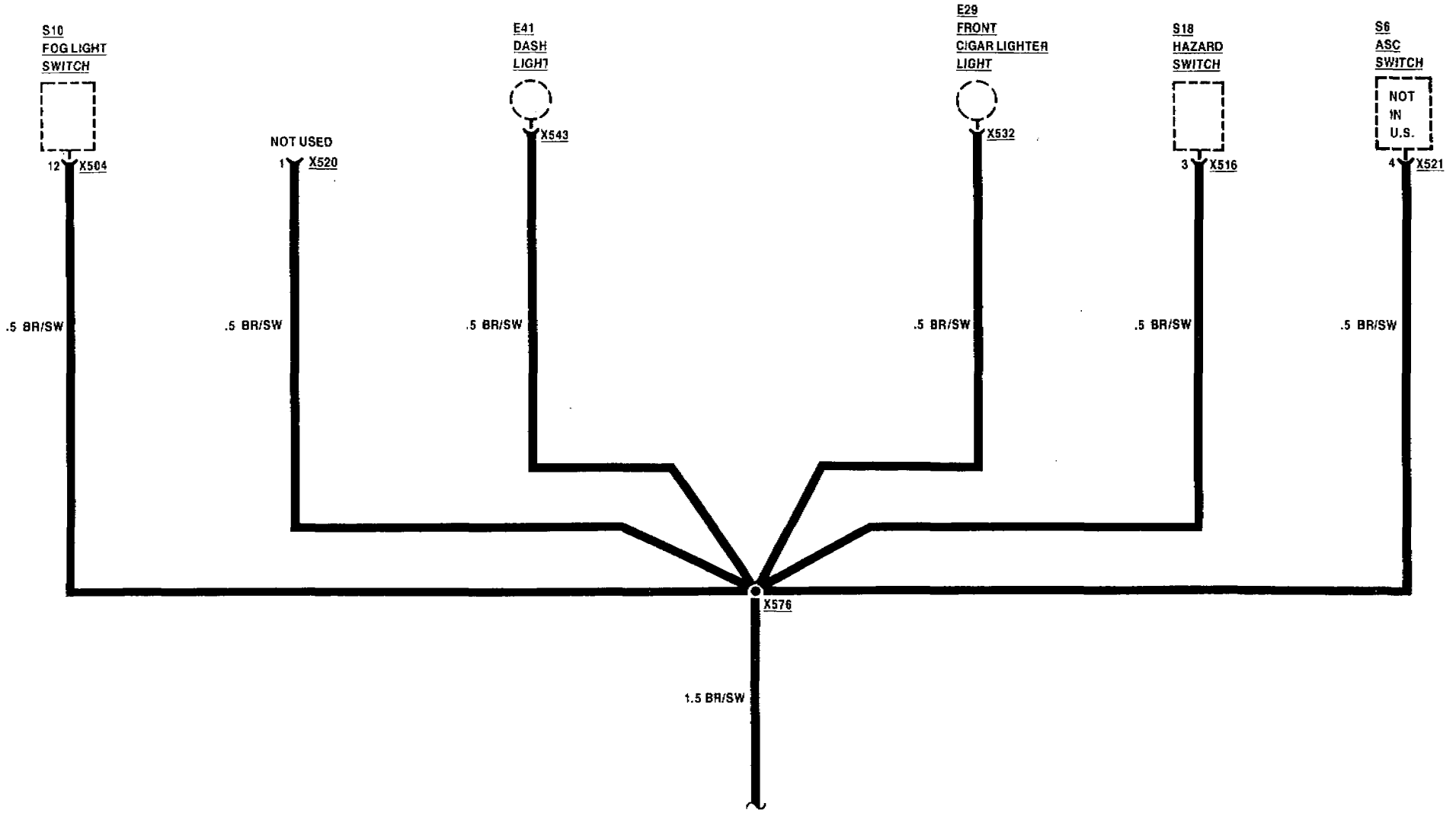

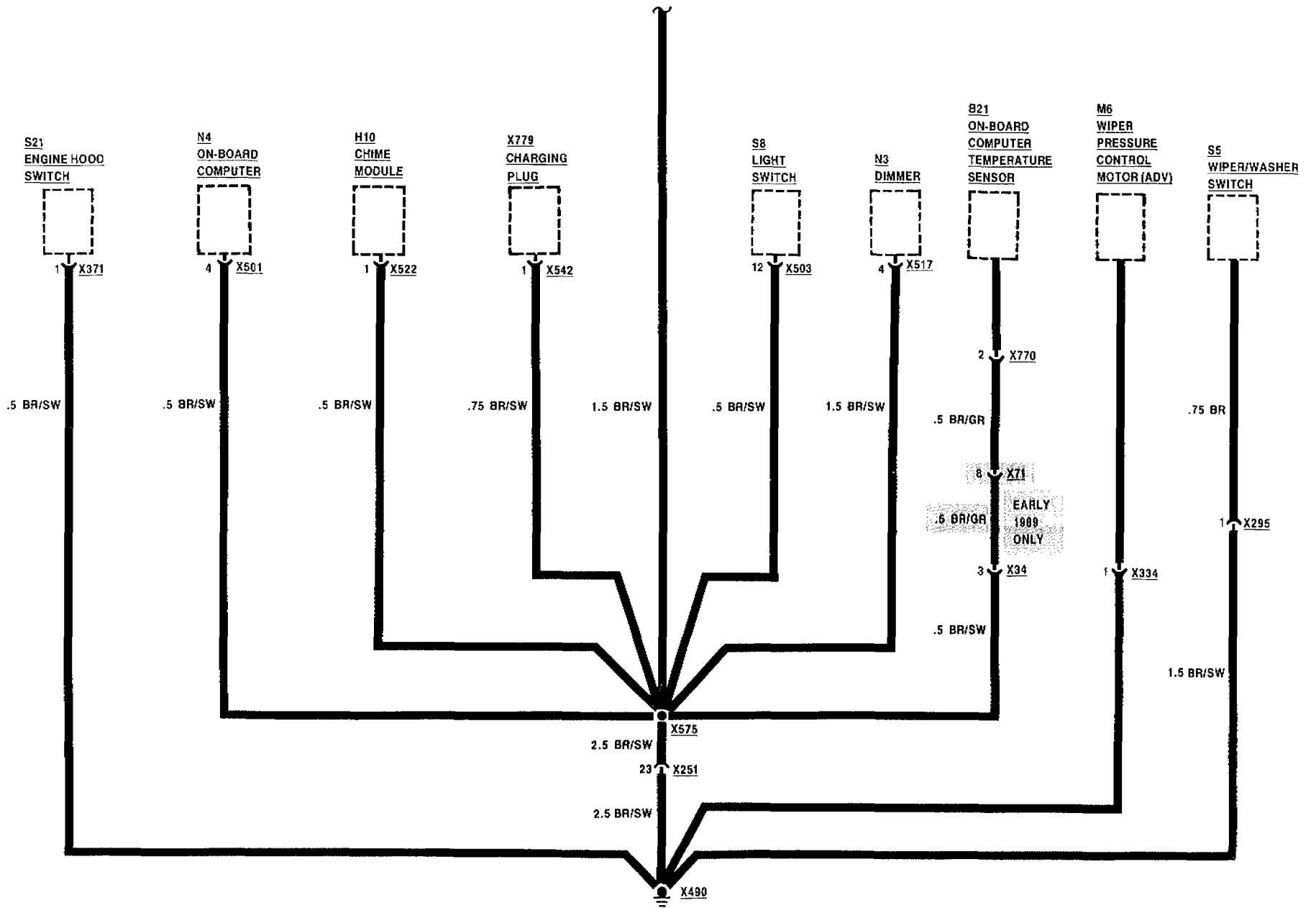



GROUND DISTRIBUTION

GROUND X491

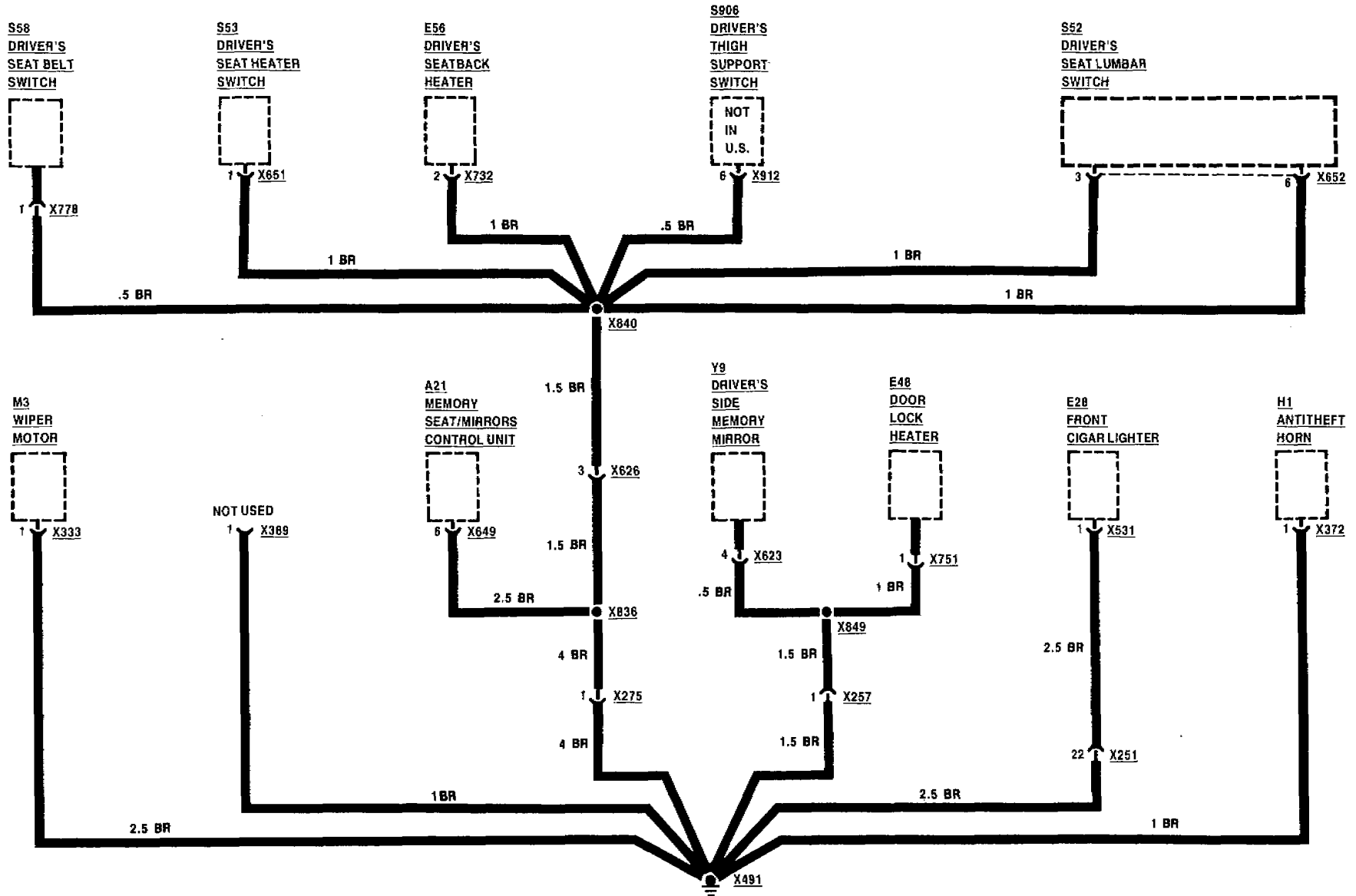



GROUND DISTRIBUTION

GROUND X492

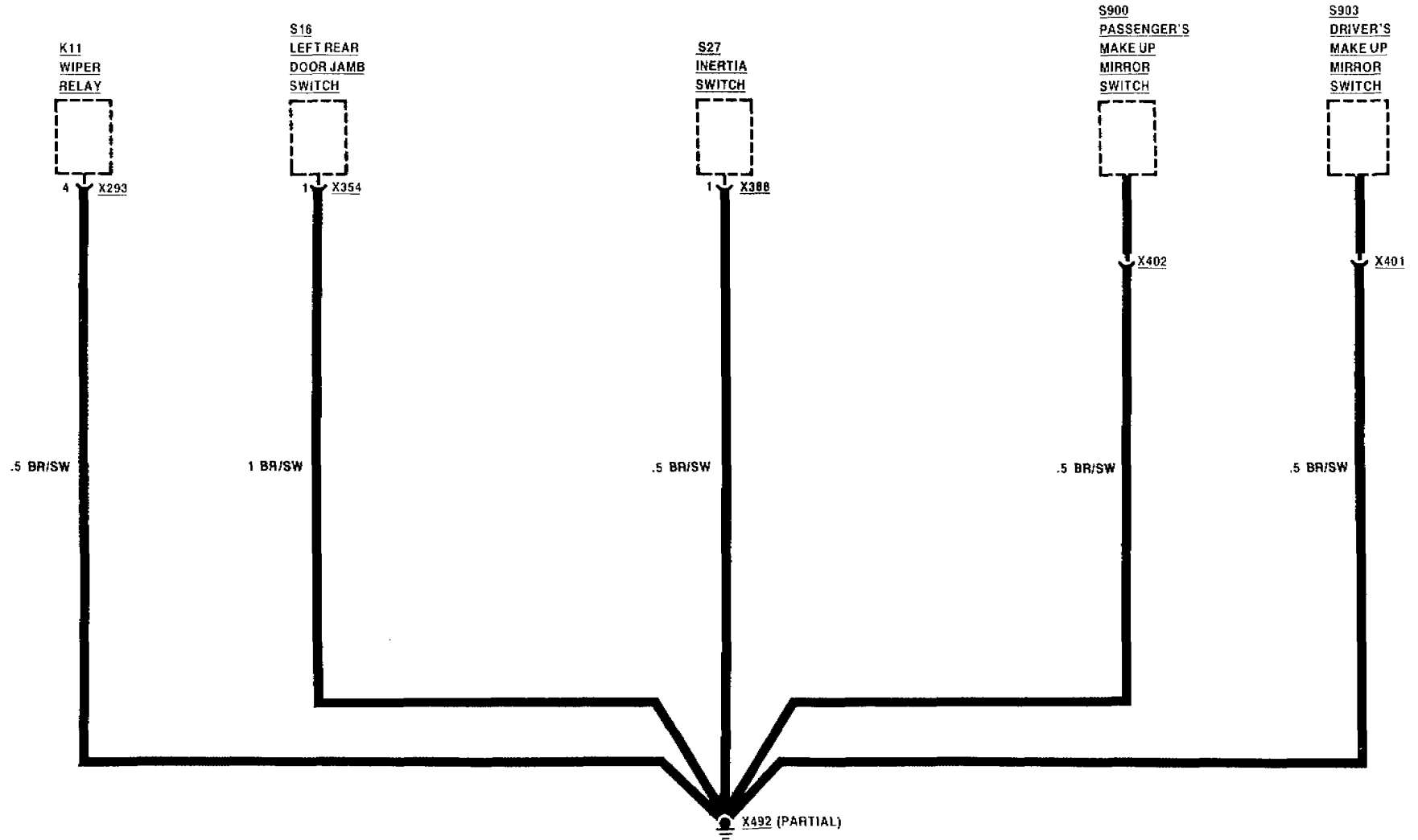



GROUND DISTRIBUTION

GROUND X492

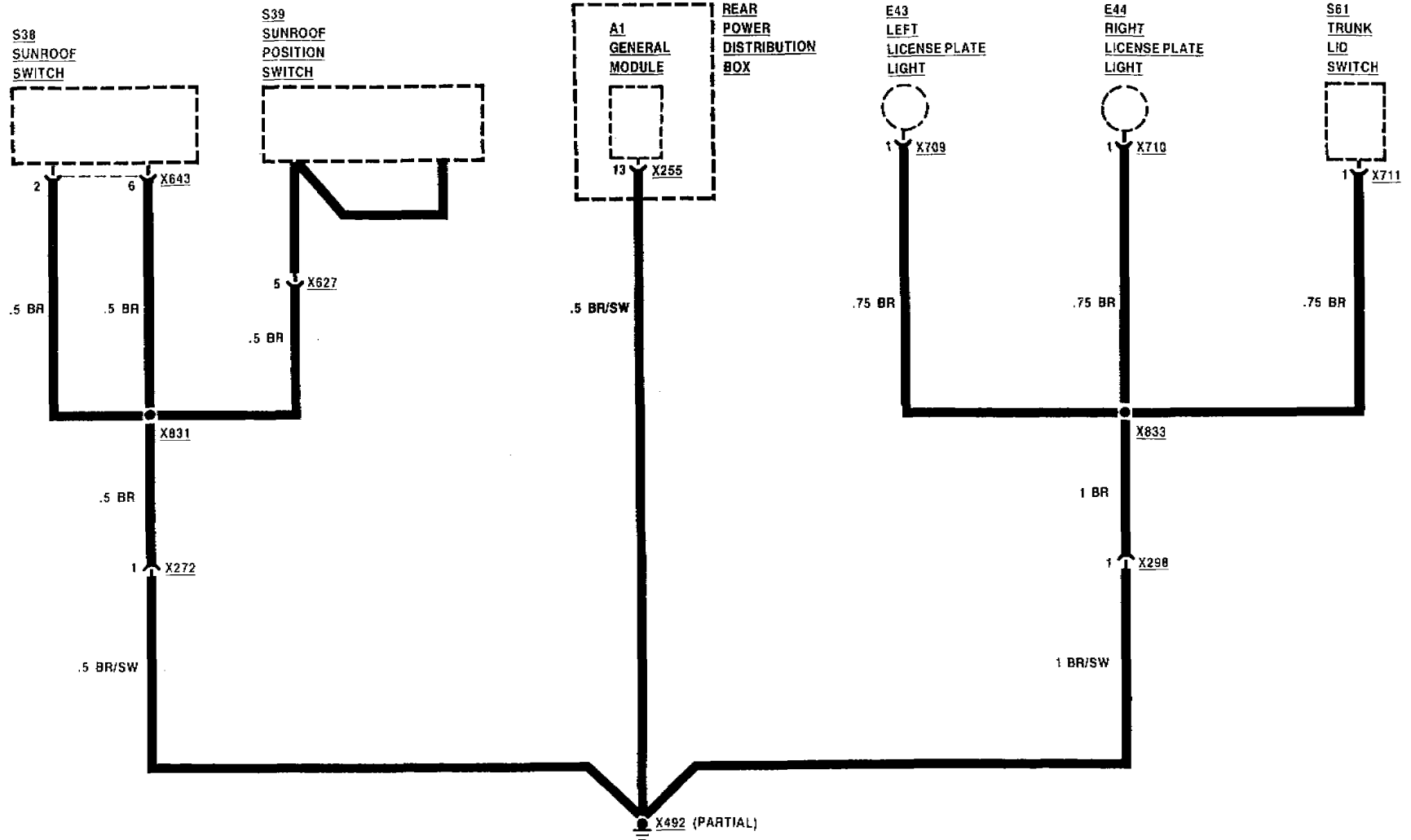



GROUND DISTRIBUTION

GROUND X493

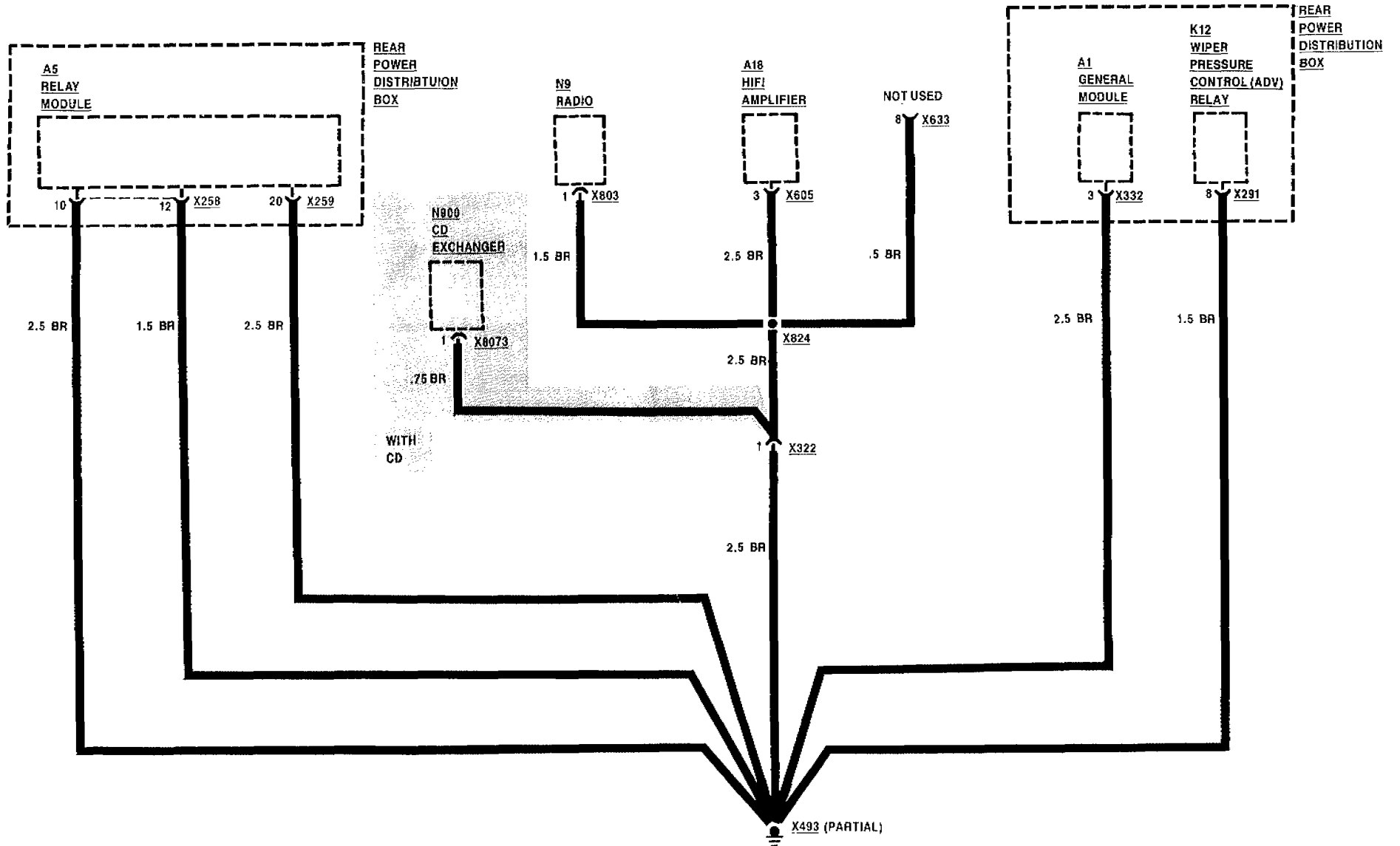



GROUND DISTRIBUTION

GROUND X493

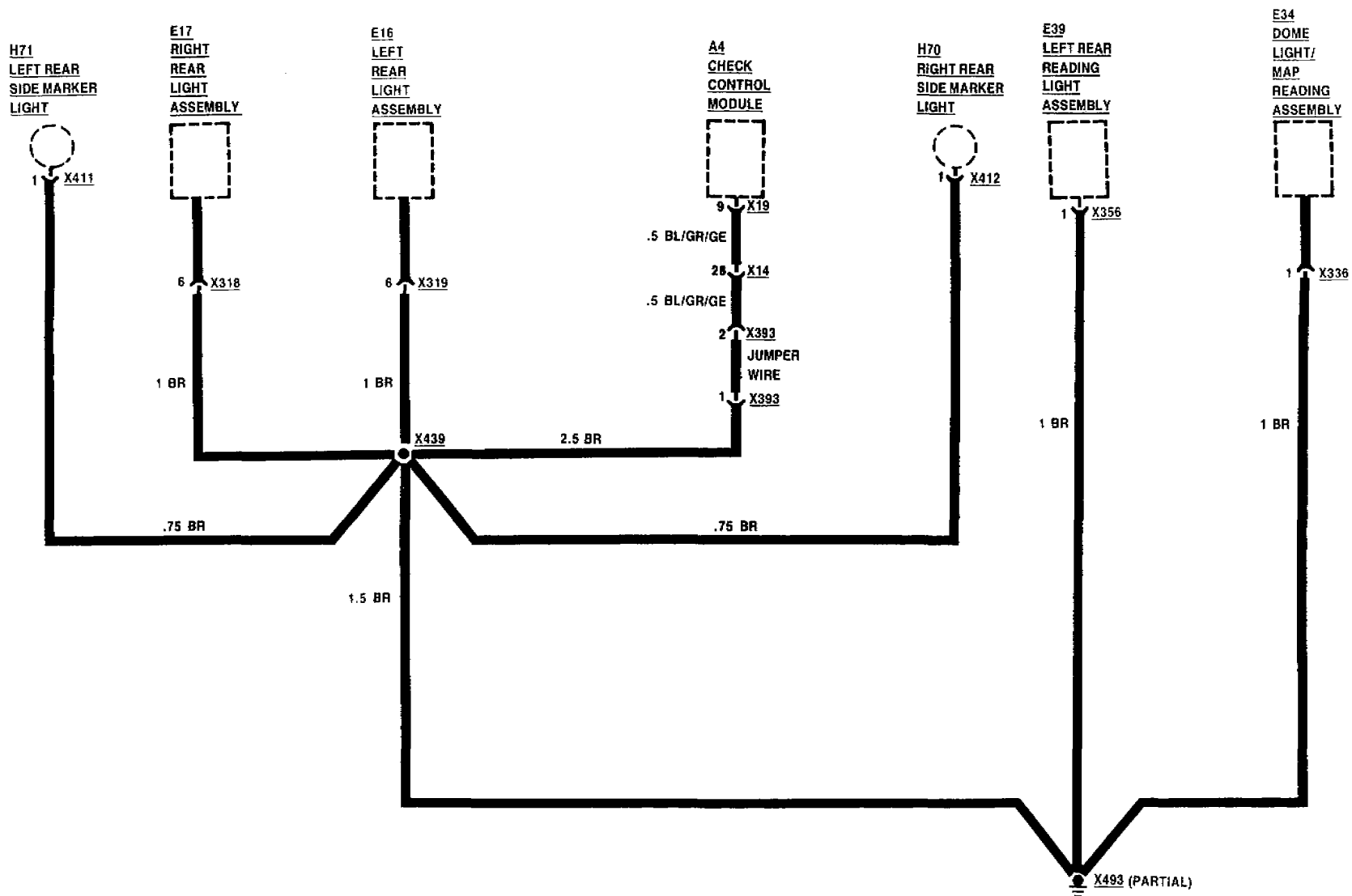



GROUND DISTRIBUTION

GROUND X494

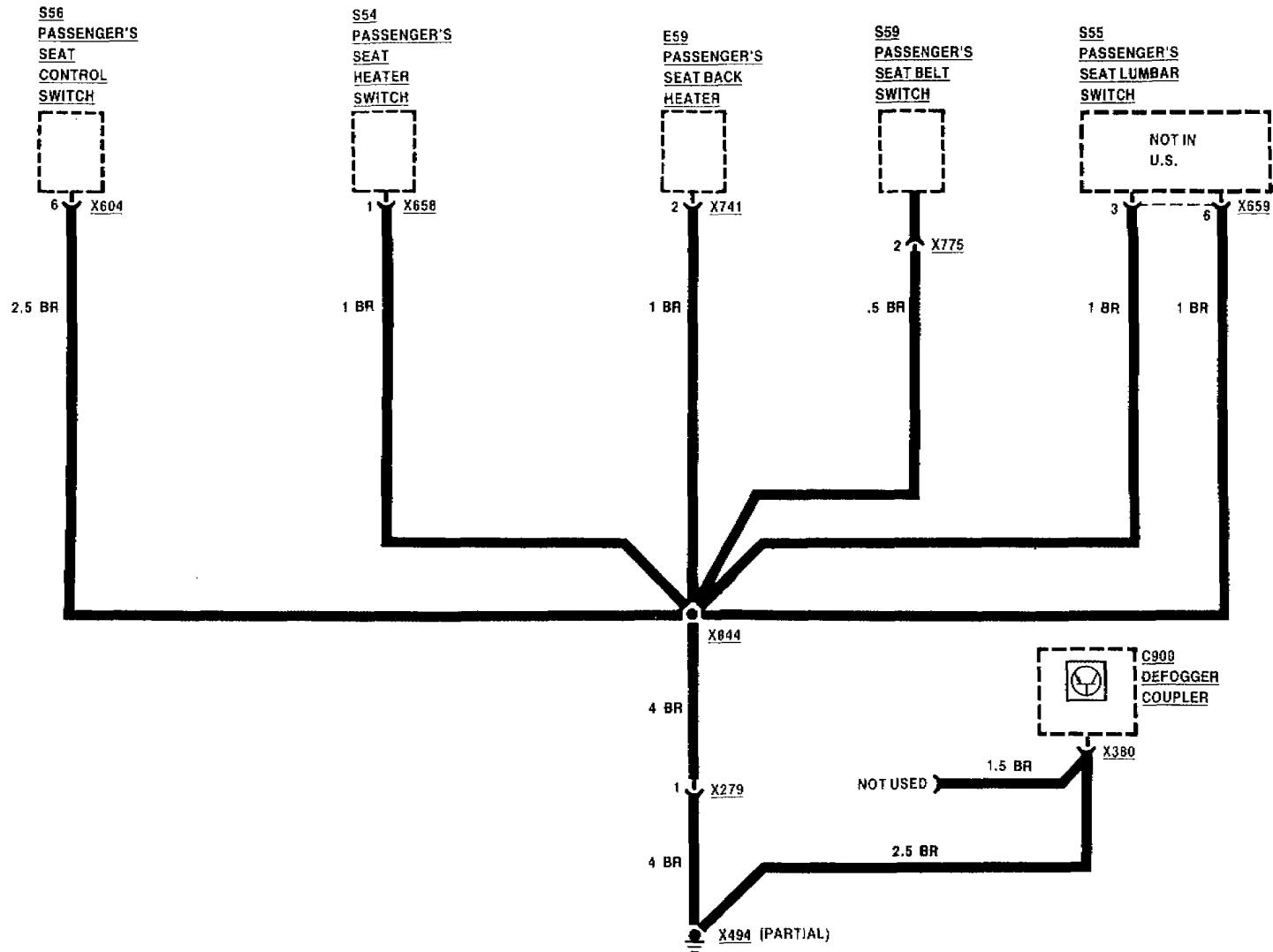



GROUND DISTRIBUTION

GROUND X494

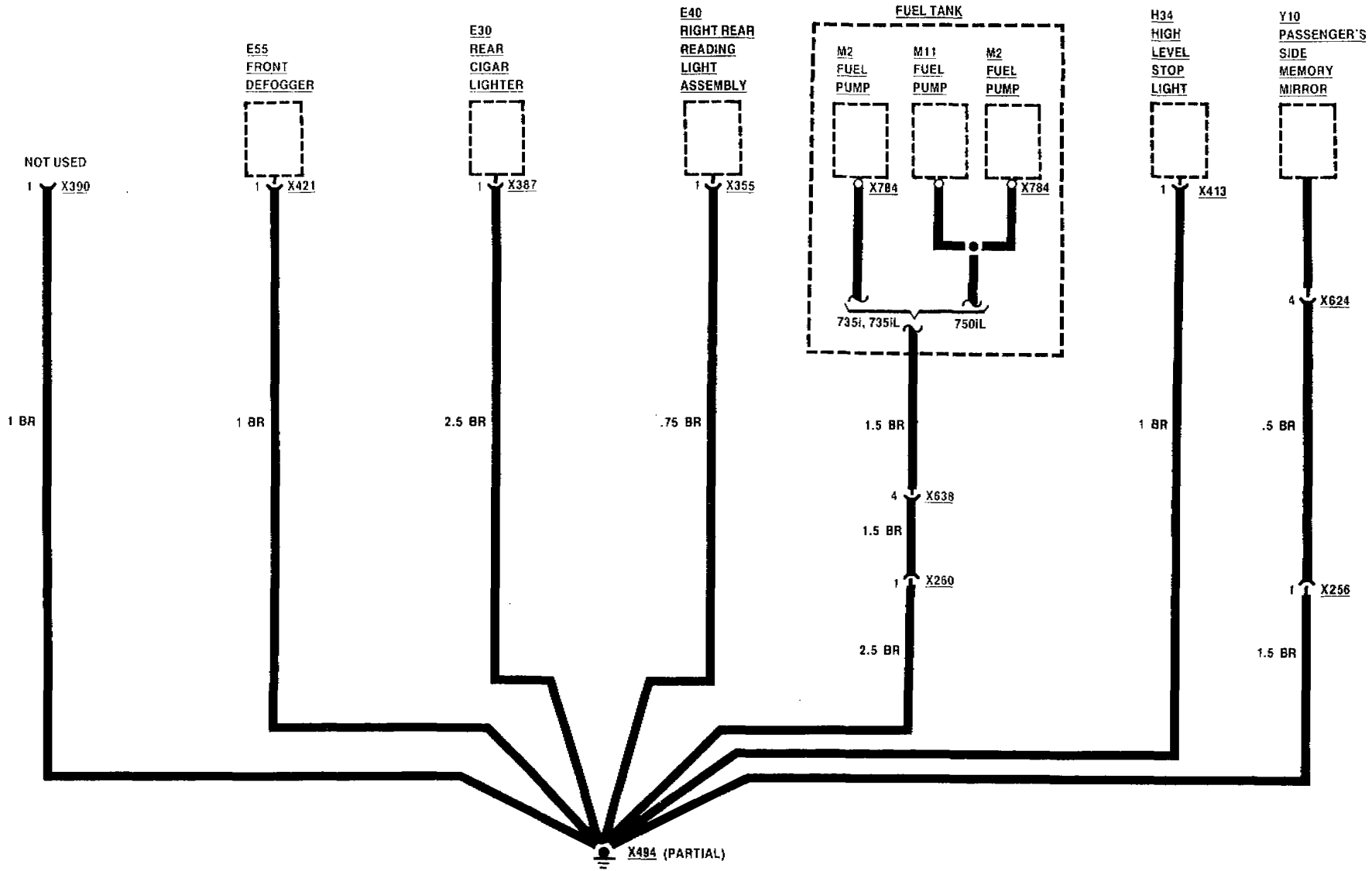



GROUND DISTRIBUTION

GROUND X497

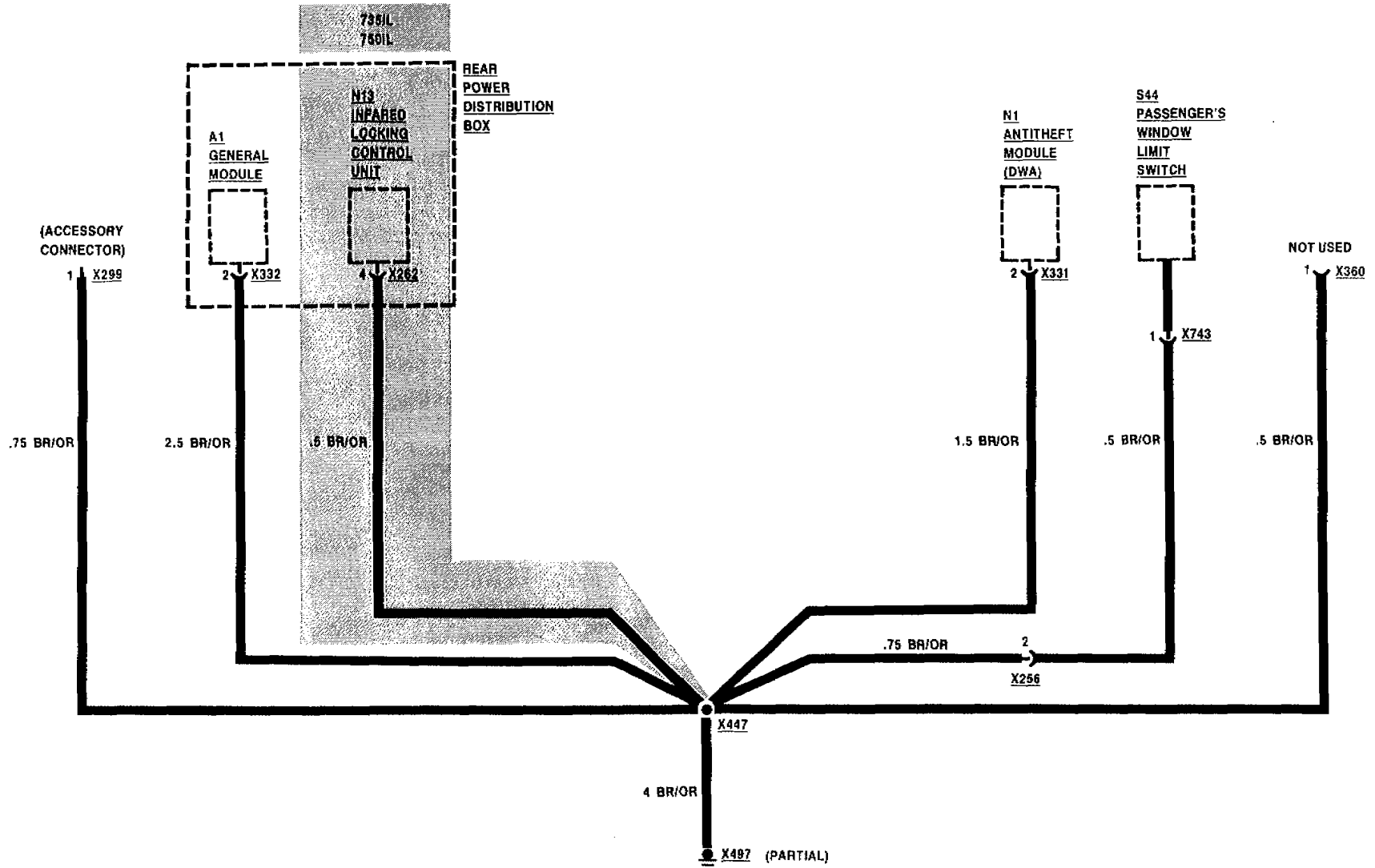

09/88

0672-15

1989



GROUND DISTRIBUTION

GROUND X497

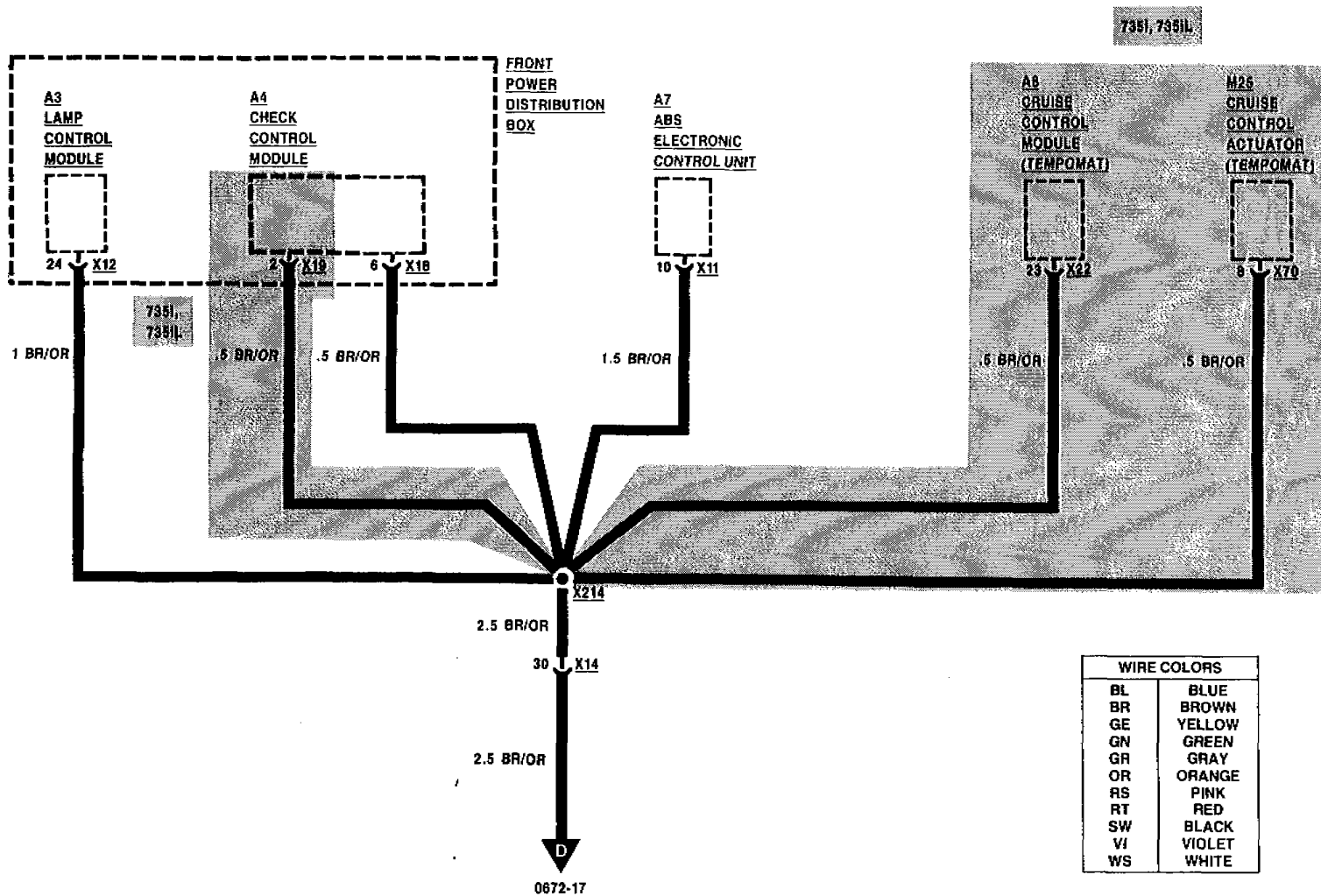



GROUND DISTRIBUTION GROUND X497

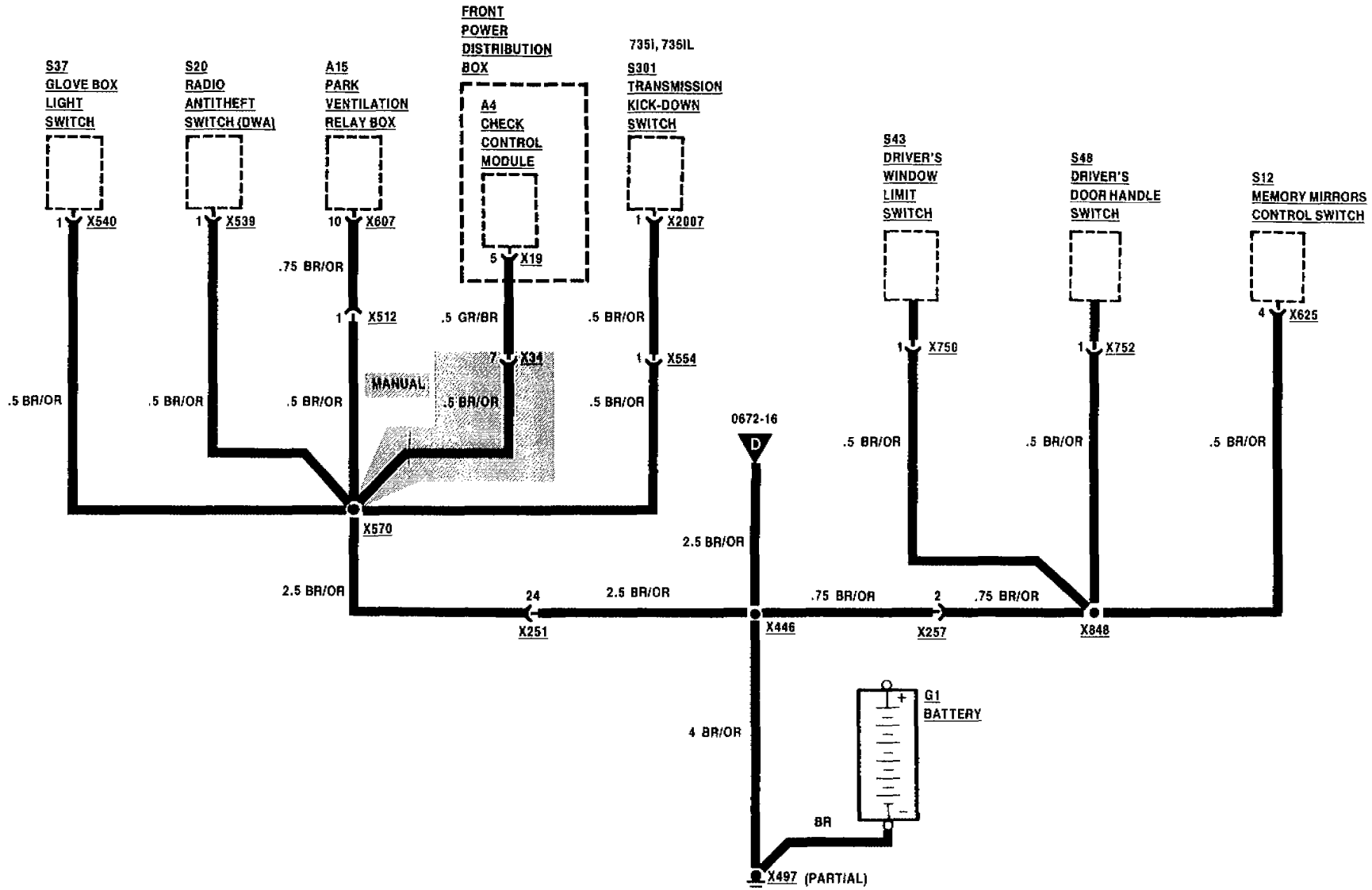



GROUND DISTRIBUTION GROUND X498

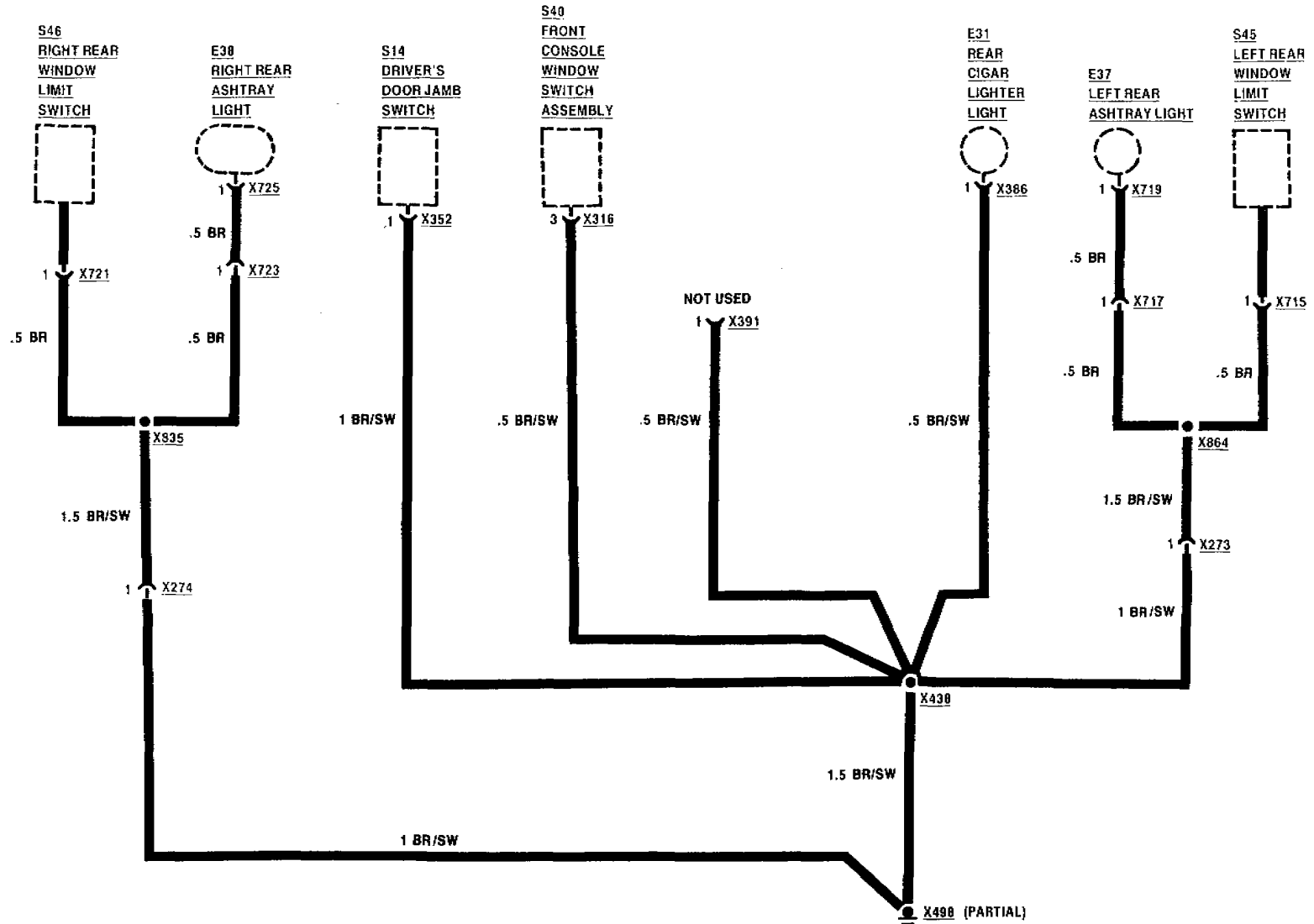



GROUND DISTRIBUTION

GROUND X498

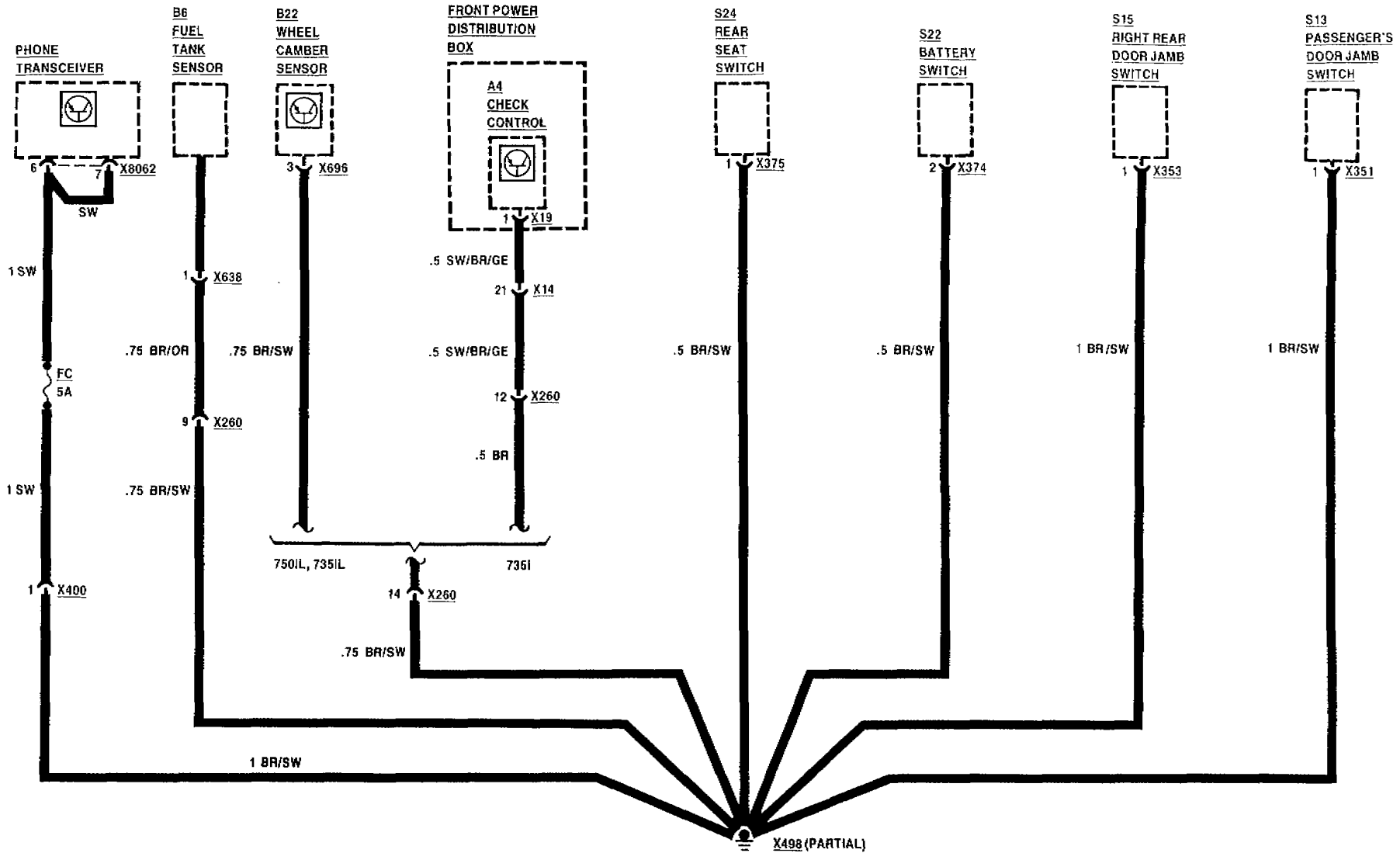



GROUND DISTRIBUTION

735iL, 750iL

GROUND X814

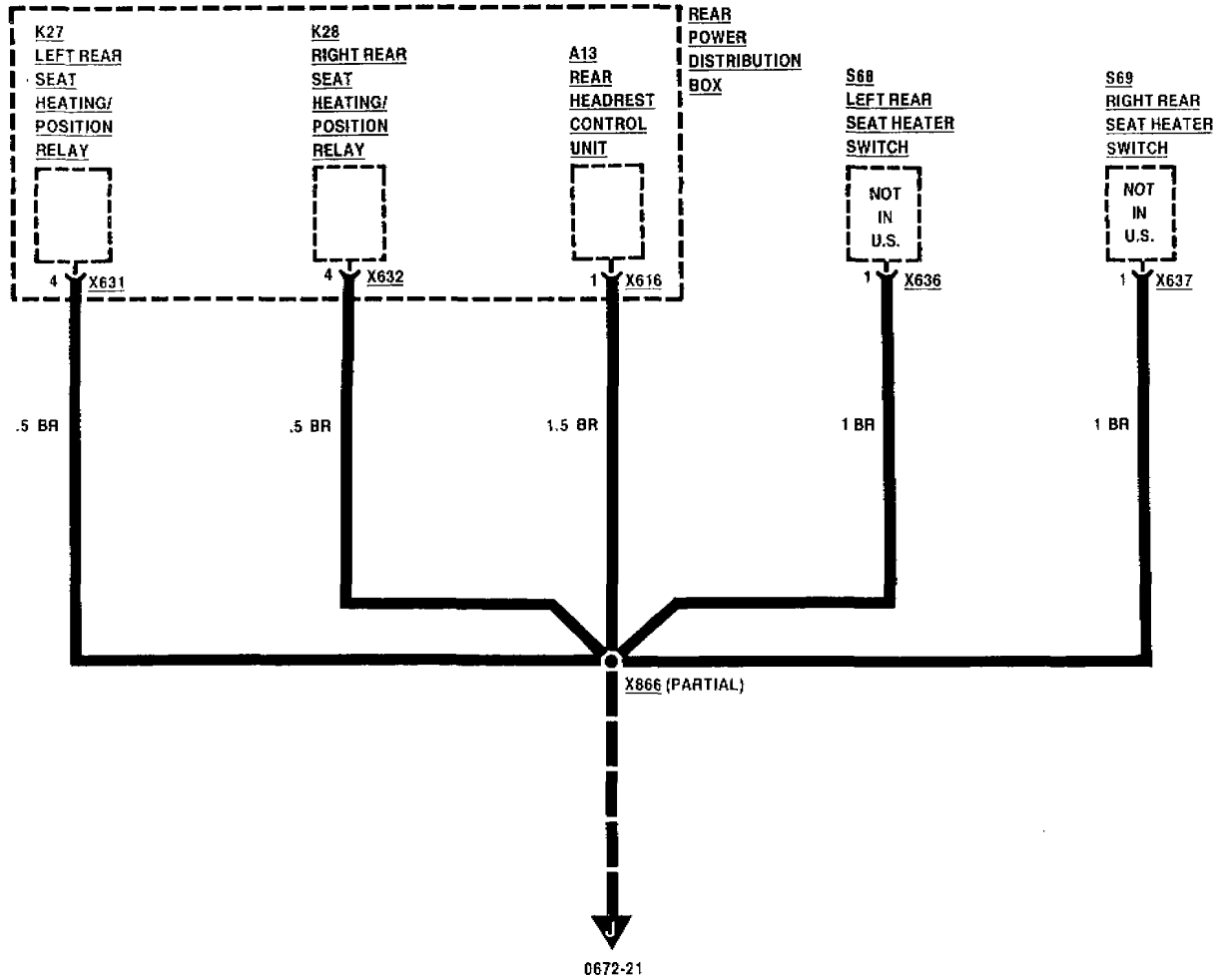

09/88

0672-20

1989



GROUND DISTRIBUTION

735iL, 750iL

GROUND X814

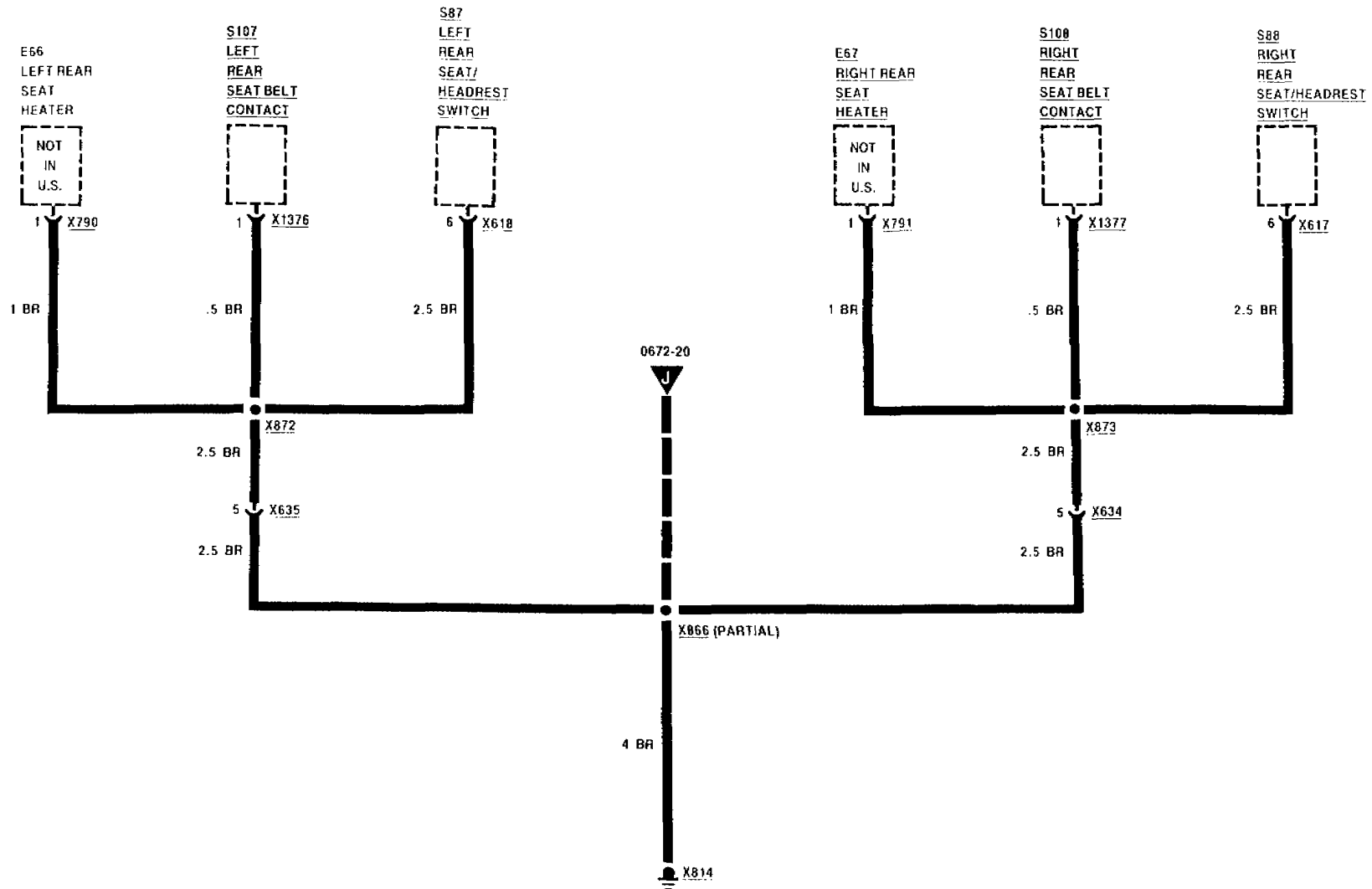

09/88

0672-21

1989



GROUND DISTRIBUTION

GROUNDS X818, X905, X2008

WIRE COLORS	
BL	BLUE
BR	BROWN
GE	YELLOW
GN	GREEN
GR	GRAY
OR	ORANGE
RS	PINK
RT	RED
SW	BLACK
VI	VIOLET
WS	WHITE

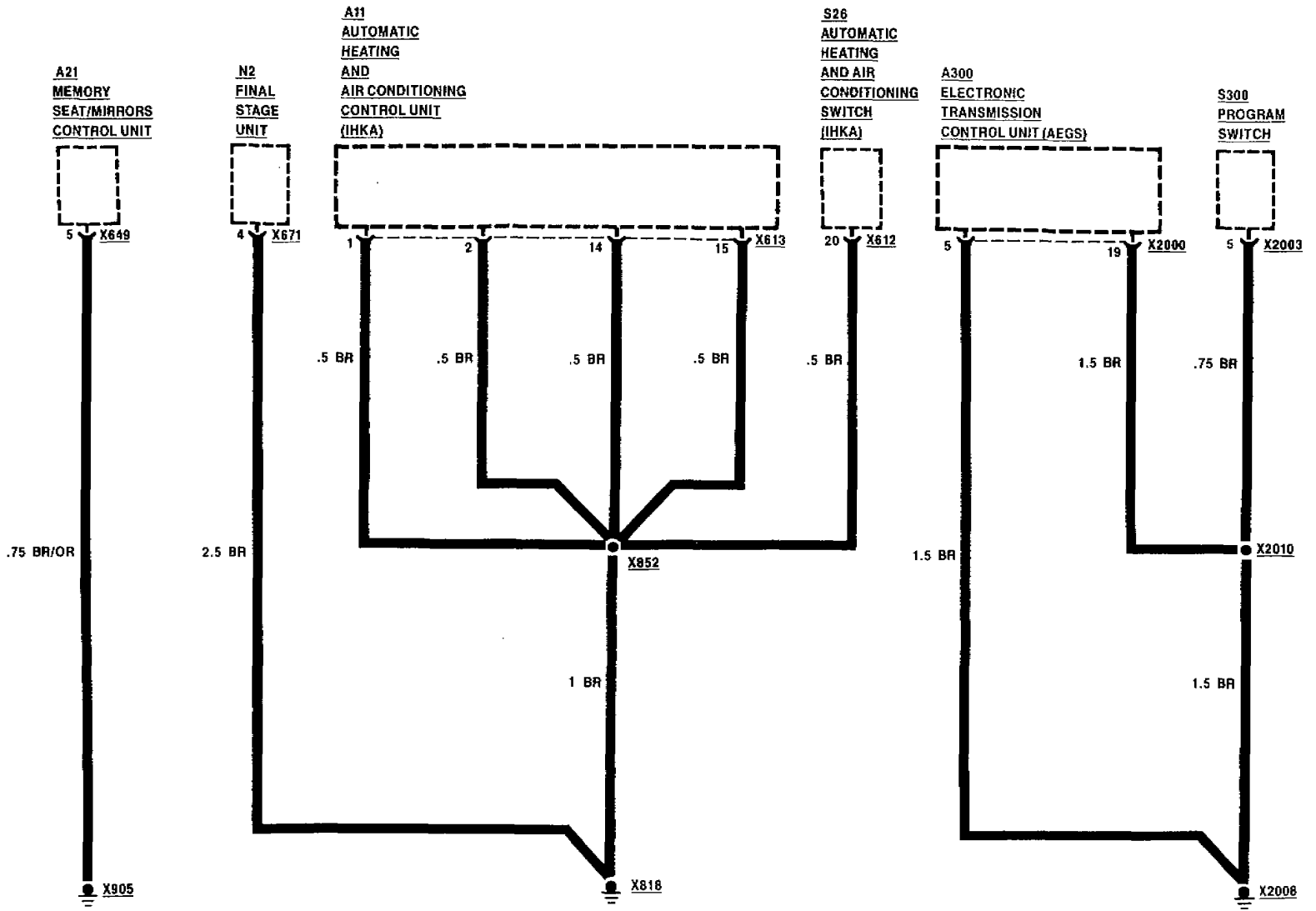



GROUND DISTRIBUTION
GROUND X1541

735i, 735iL

09/88

0672-23

1989

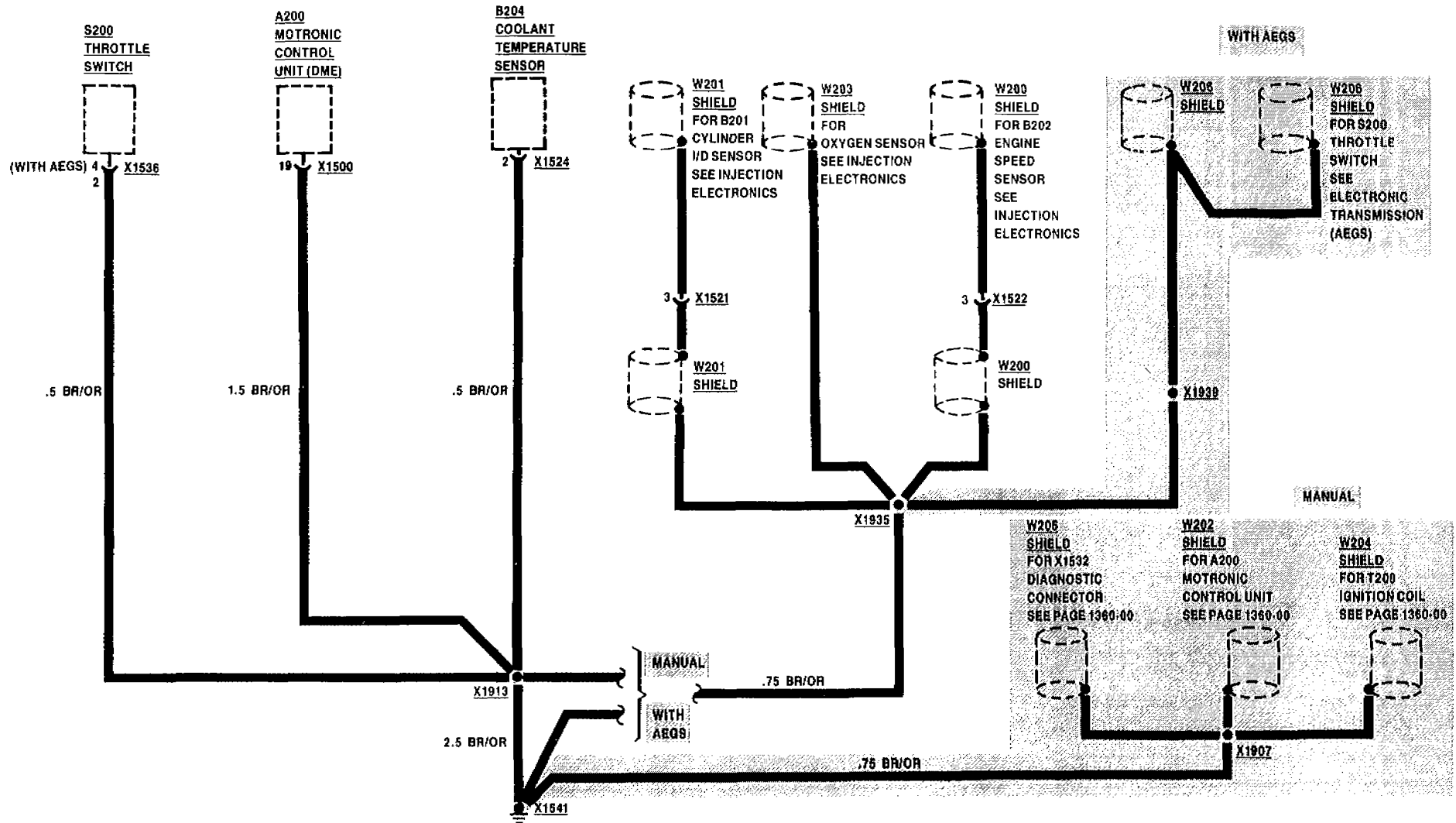



GROUND DISTRIBUTION

GROUND X1542

735i, 735iL

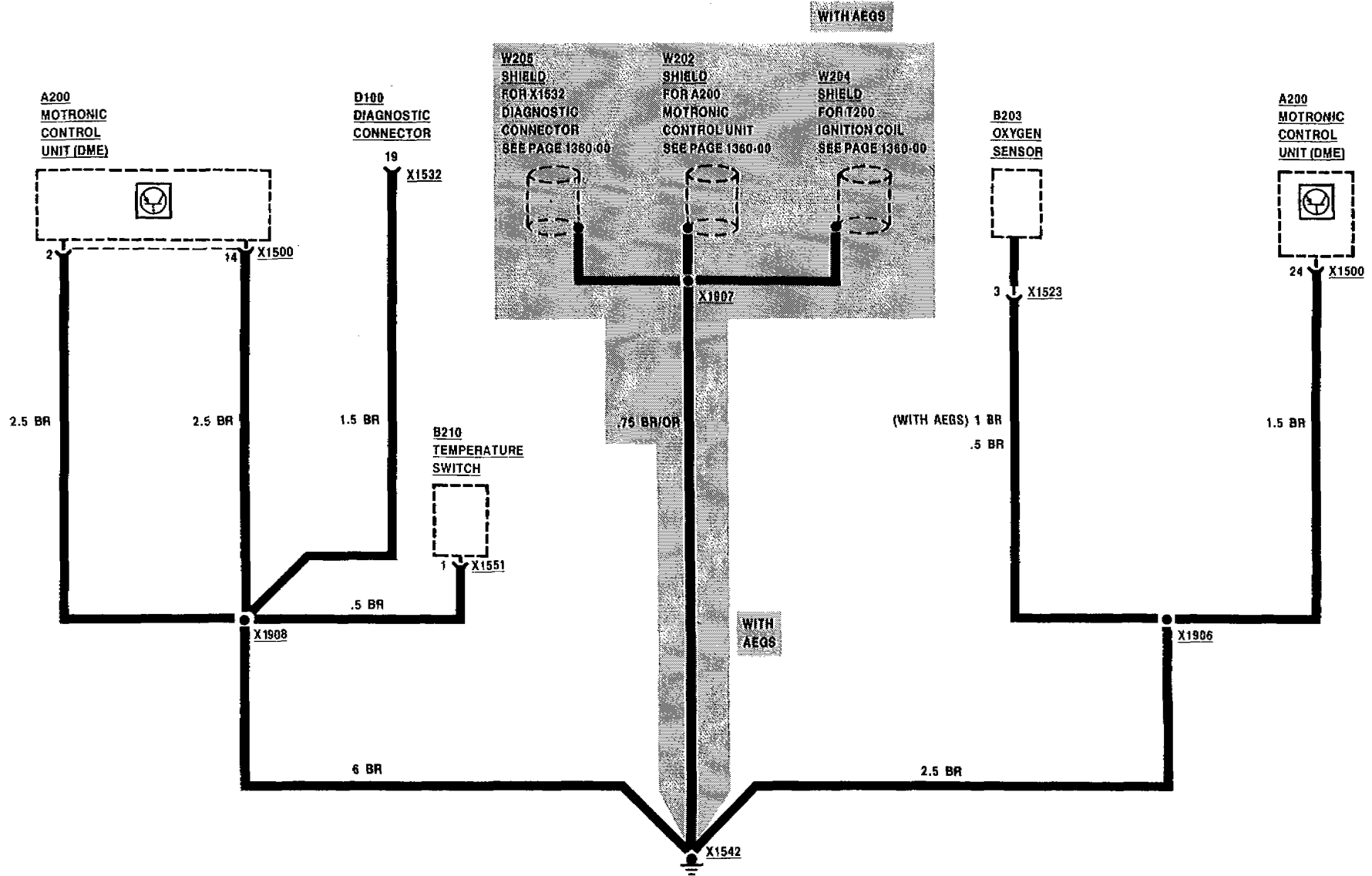



GROUND DISTRIBUTION
GROUND X1620

750iL

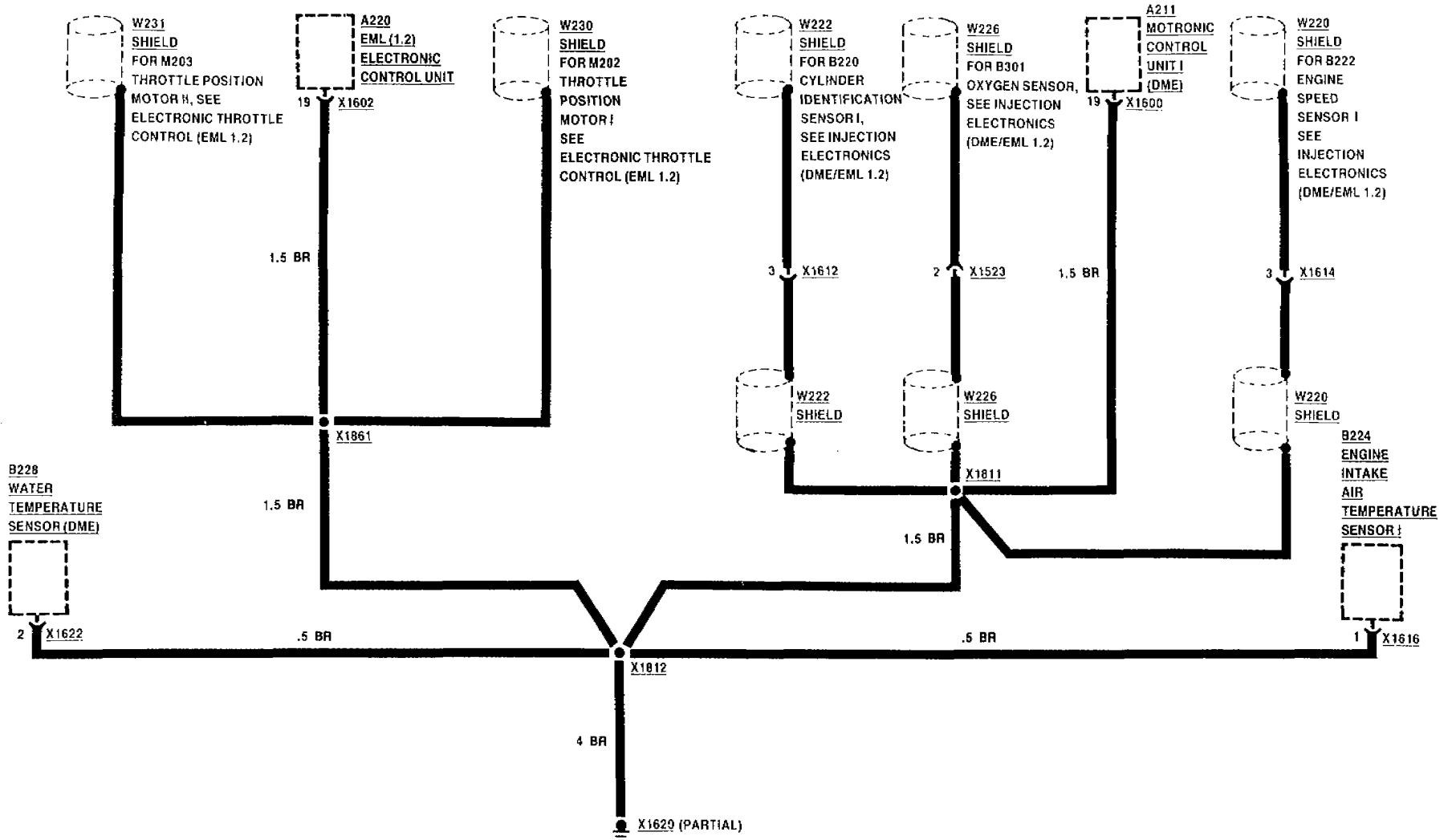

09/88

0672-25

1989



GROUND DISTRIBUTION

GROUND X1620

750iL

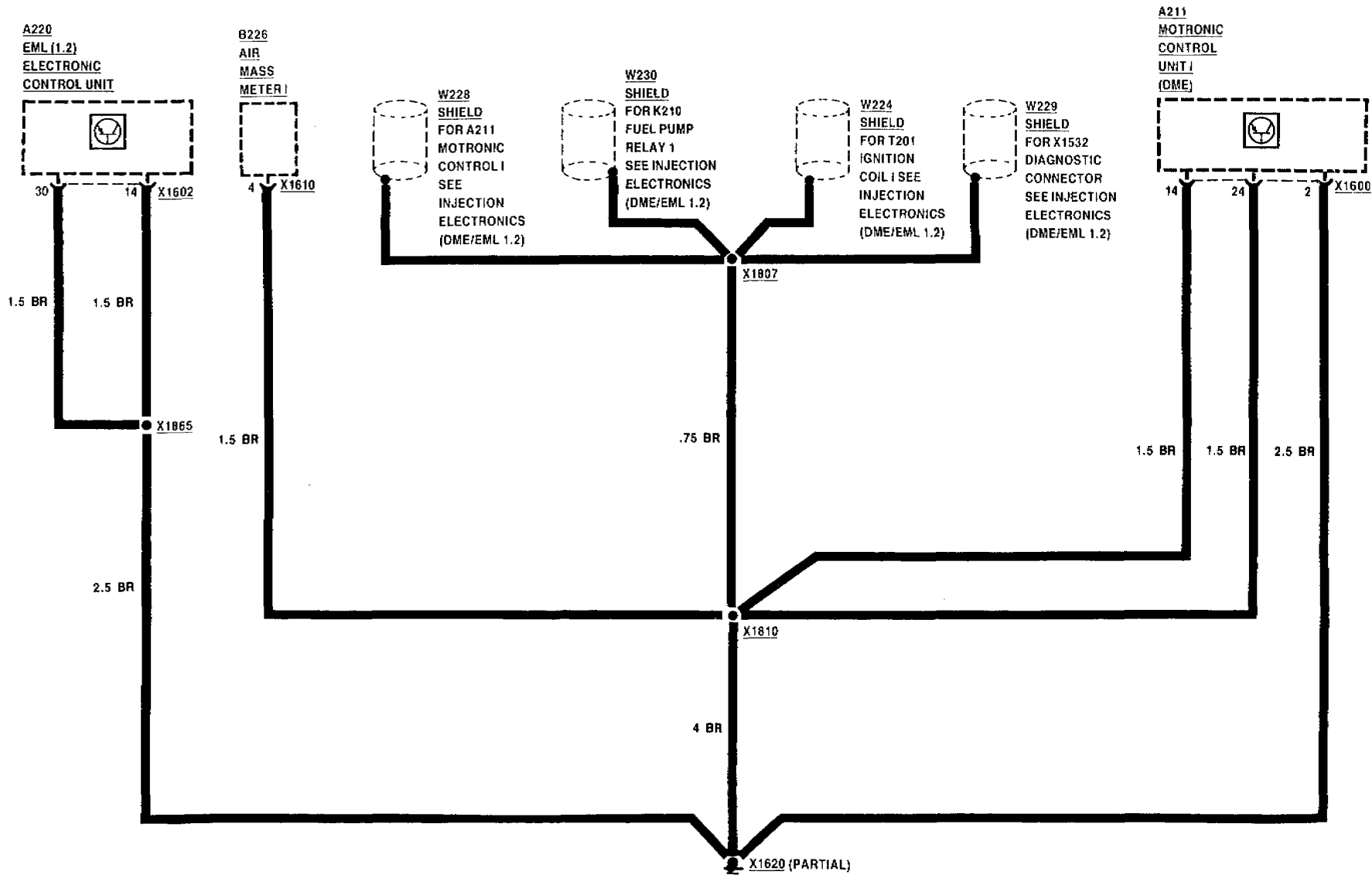



GROUND DISTRIBUTION GROUND X1621

750iL

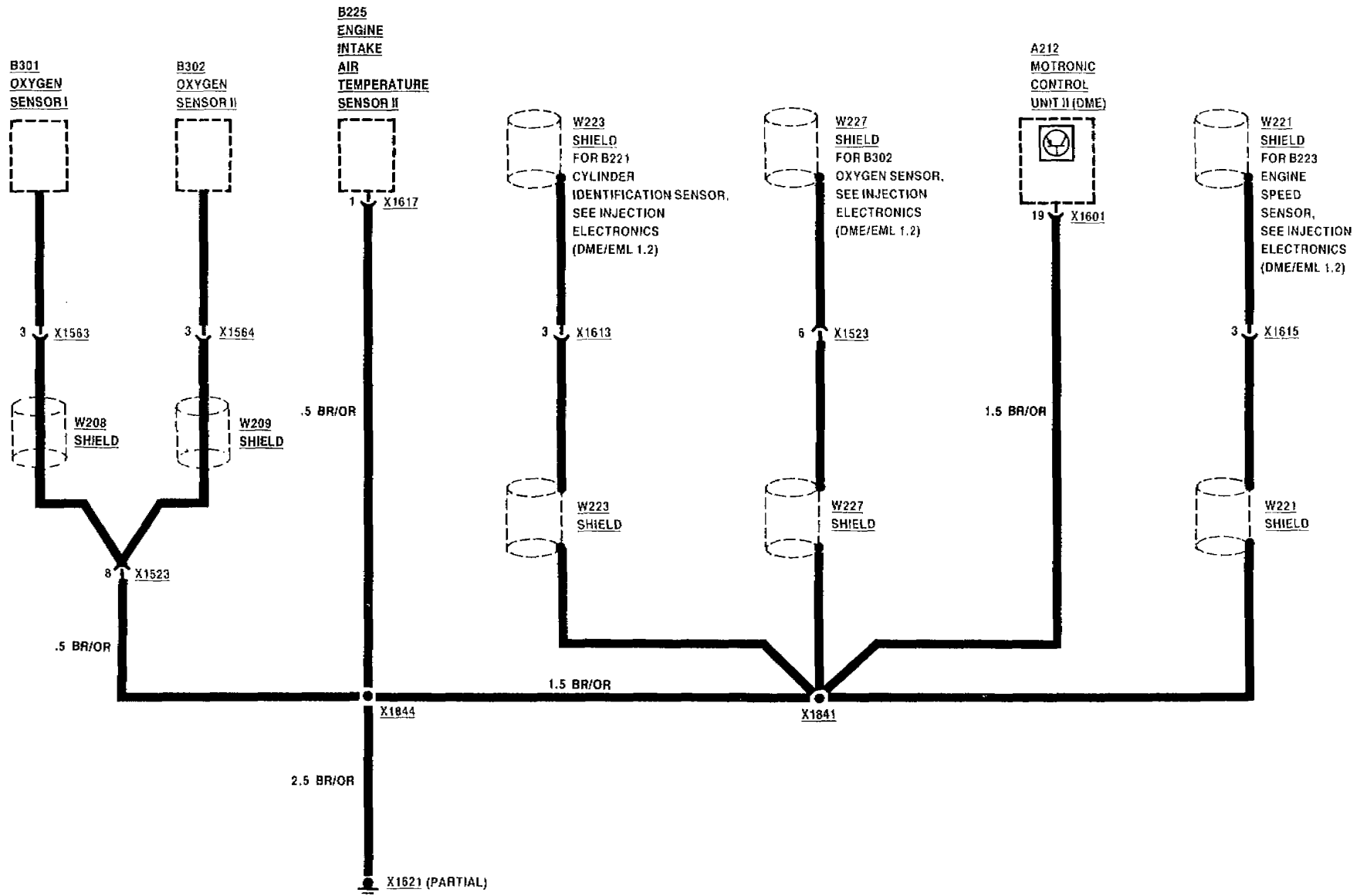



GROUND DISTRIBUTION

GROUND X1621

750iL

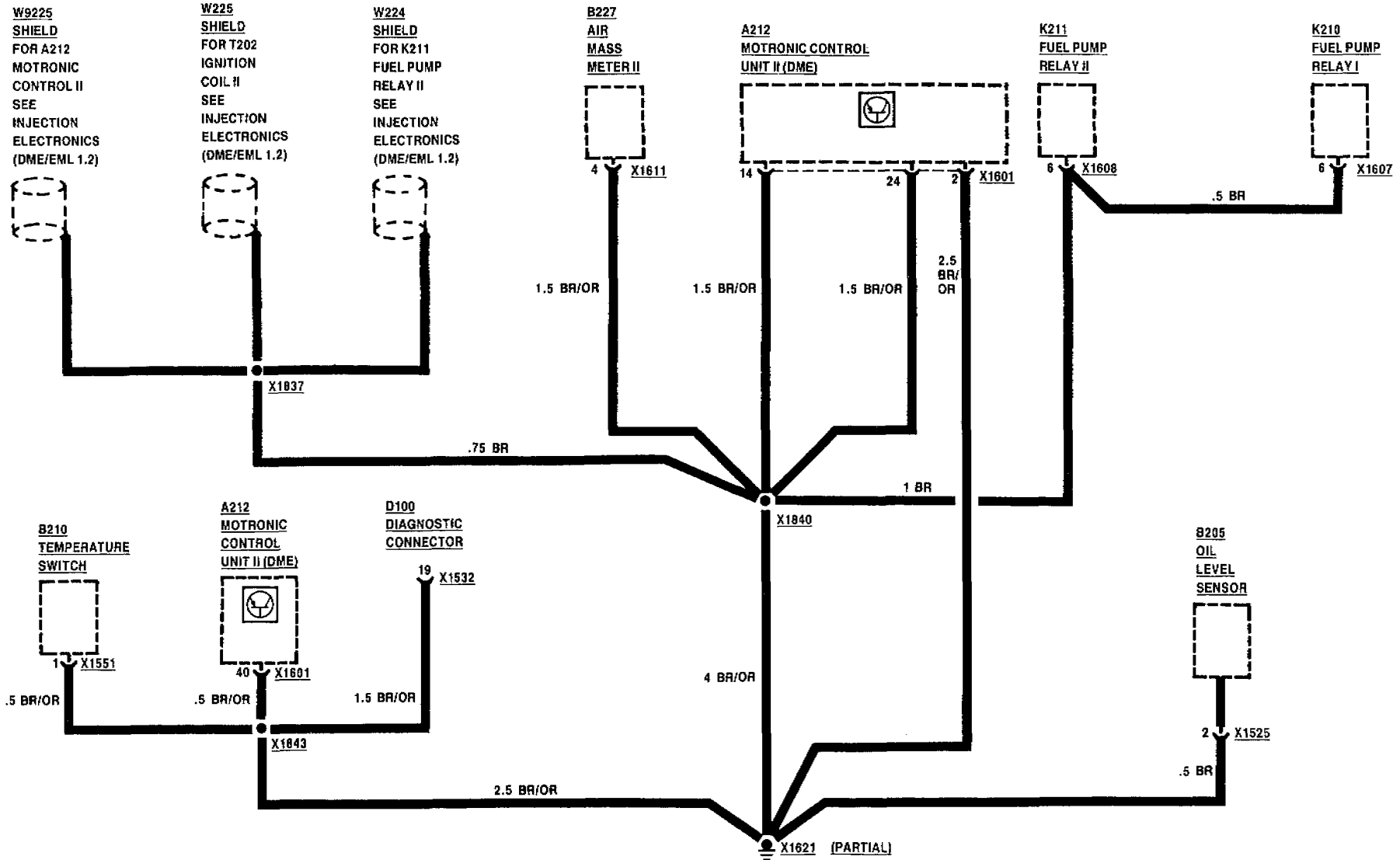



DIAGNOSTIC LINK BLOCK DIAGRAM

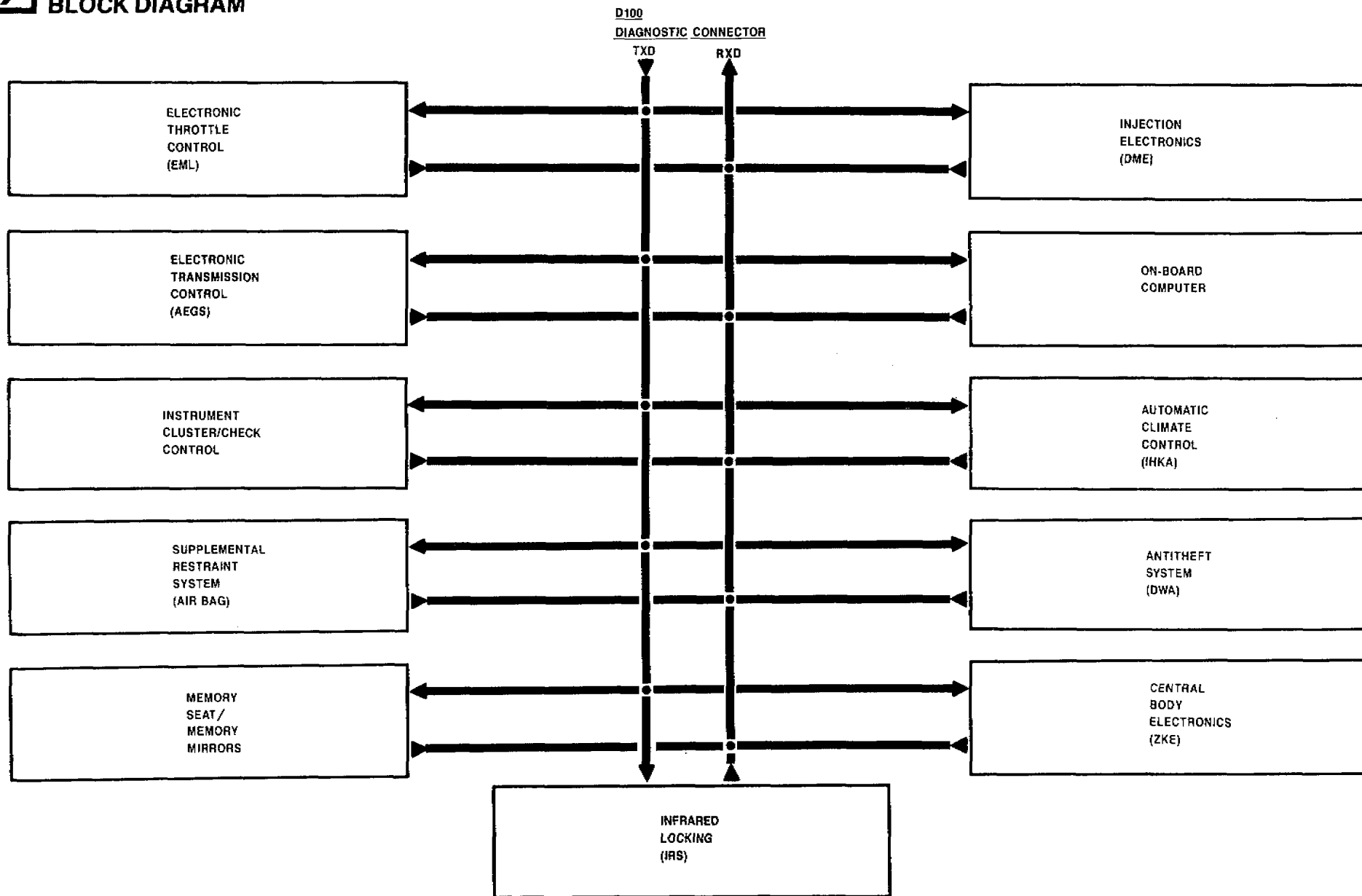



DIAGNOSTIC LINK TXD AND POWER

735i, 735iL

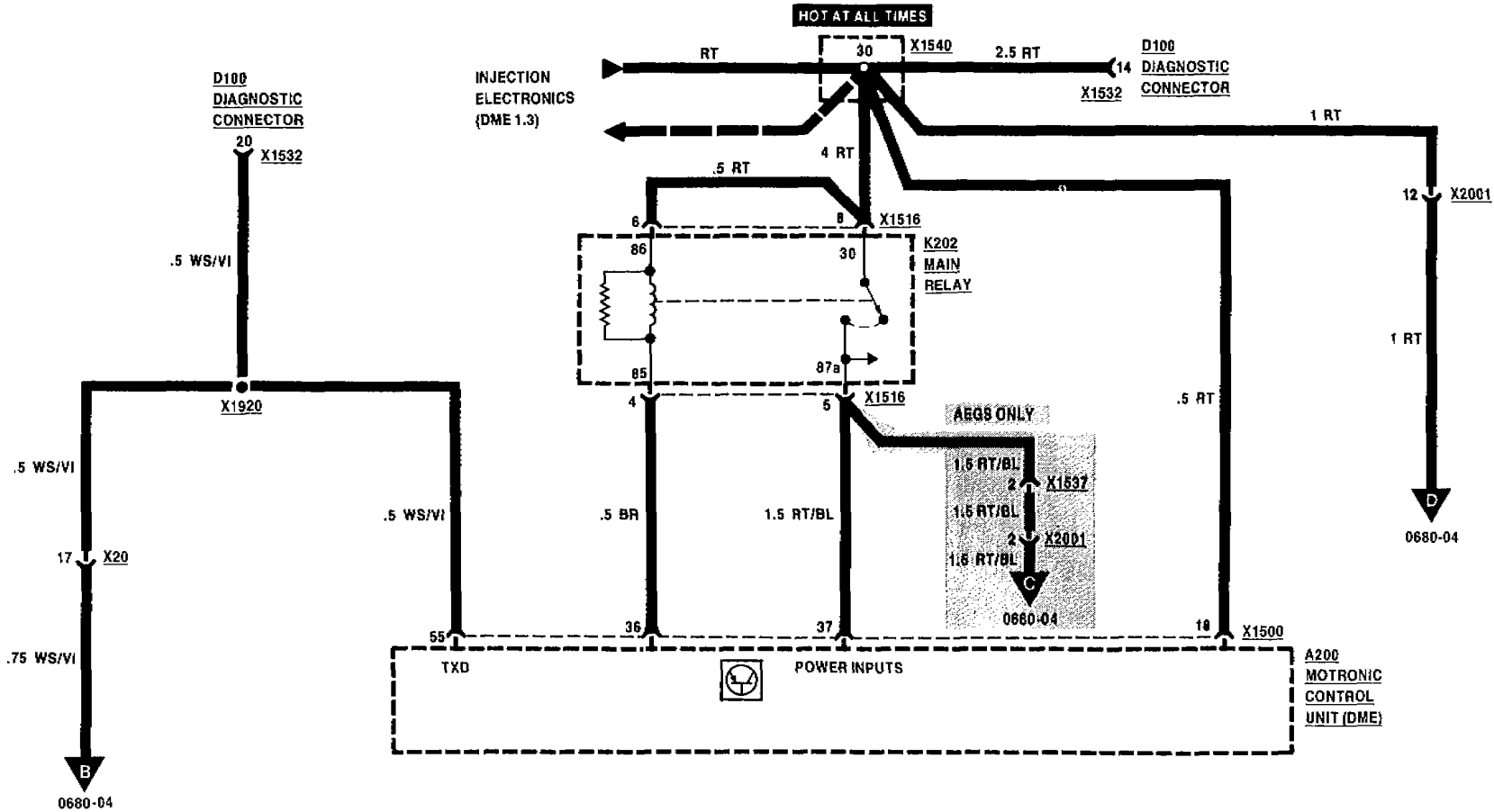

WIRE COLORS	
BL	BLUE
BR	BROWN
GE	YELLOW
GN	GREEN
GR	GRAY
OR	ORANGE
RS	PINK
RT	RED
SW	BLACK
VI	VIOLET
WS	WHITE



DIAGNOSTIC LINK TXD AND POWER

750iL

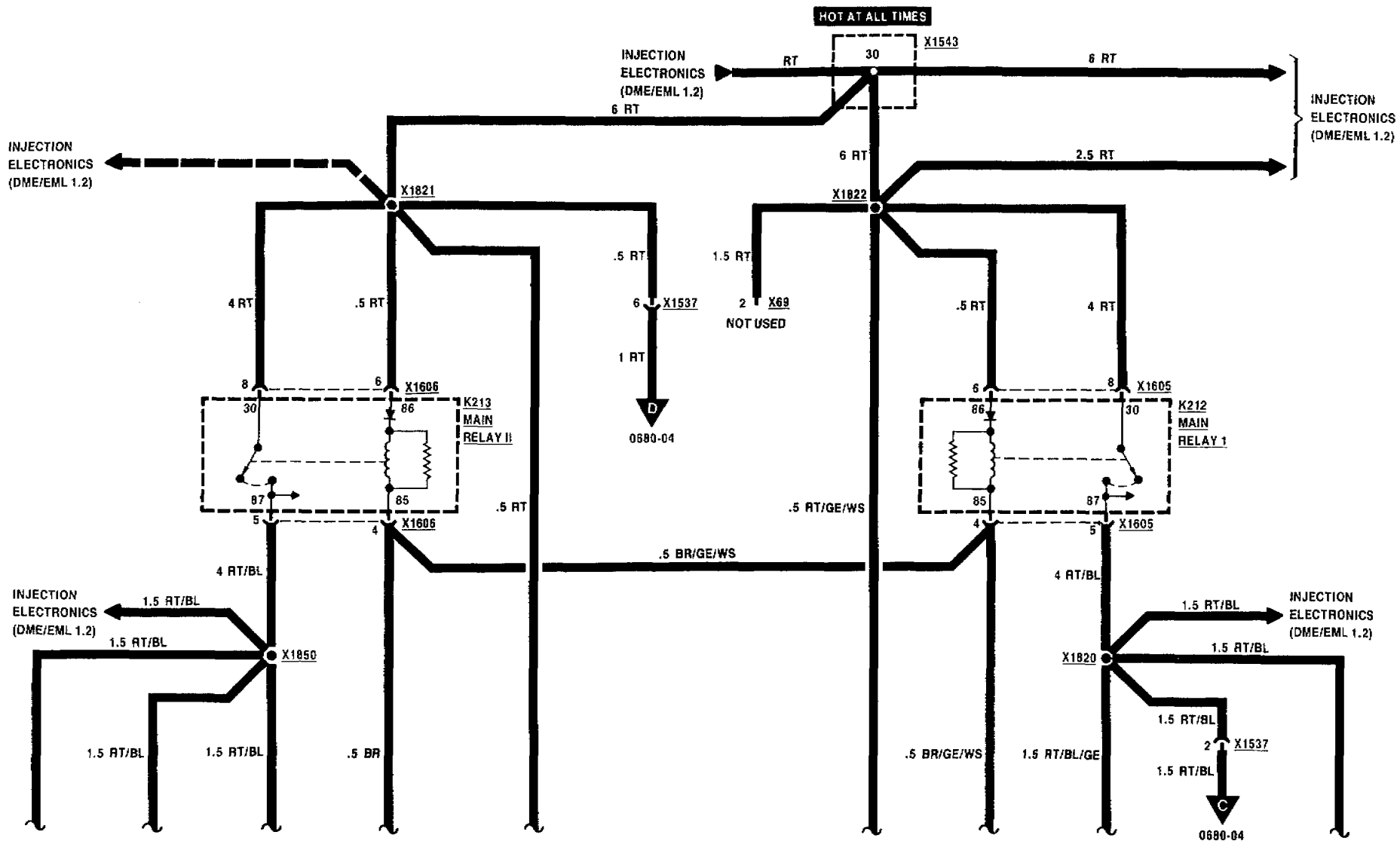

09/88
0680-02
1989

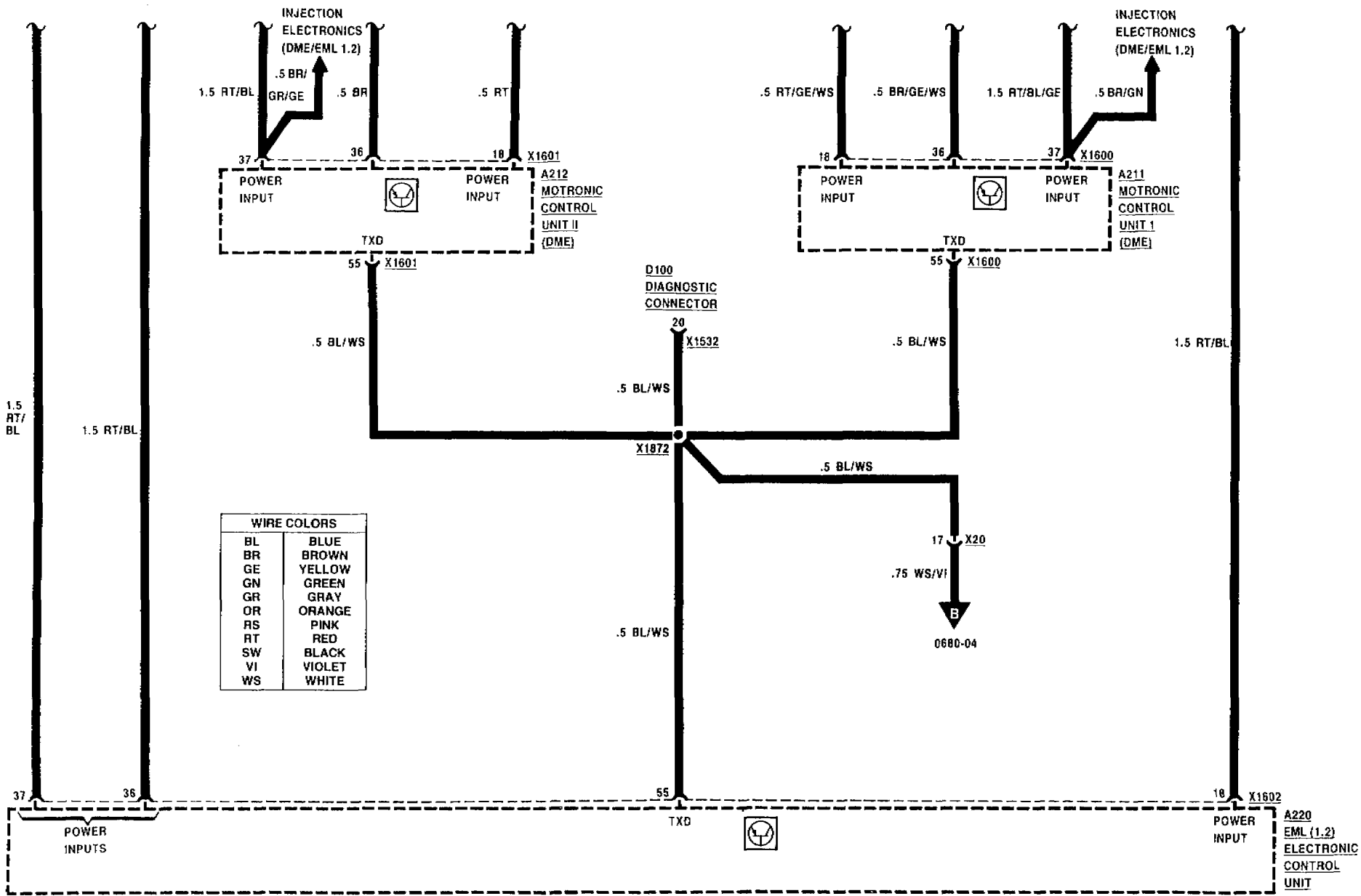

WIRE COLORS	
BL	BLUE
BR	BROWN
GE	YELLOW
GN	GREEN
GR	GRAY
OR	ORANGE
RS	PINK
RT	RED
SW	BLACK
VI	VIOLET
WS	WHITE



DIAGNOSTIC LINK TXD AND POWER

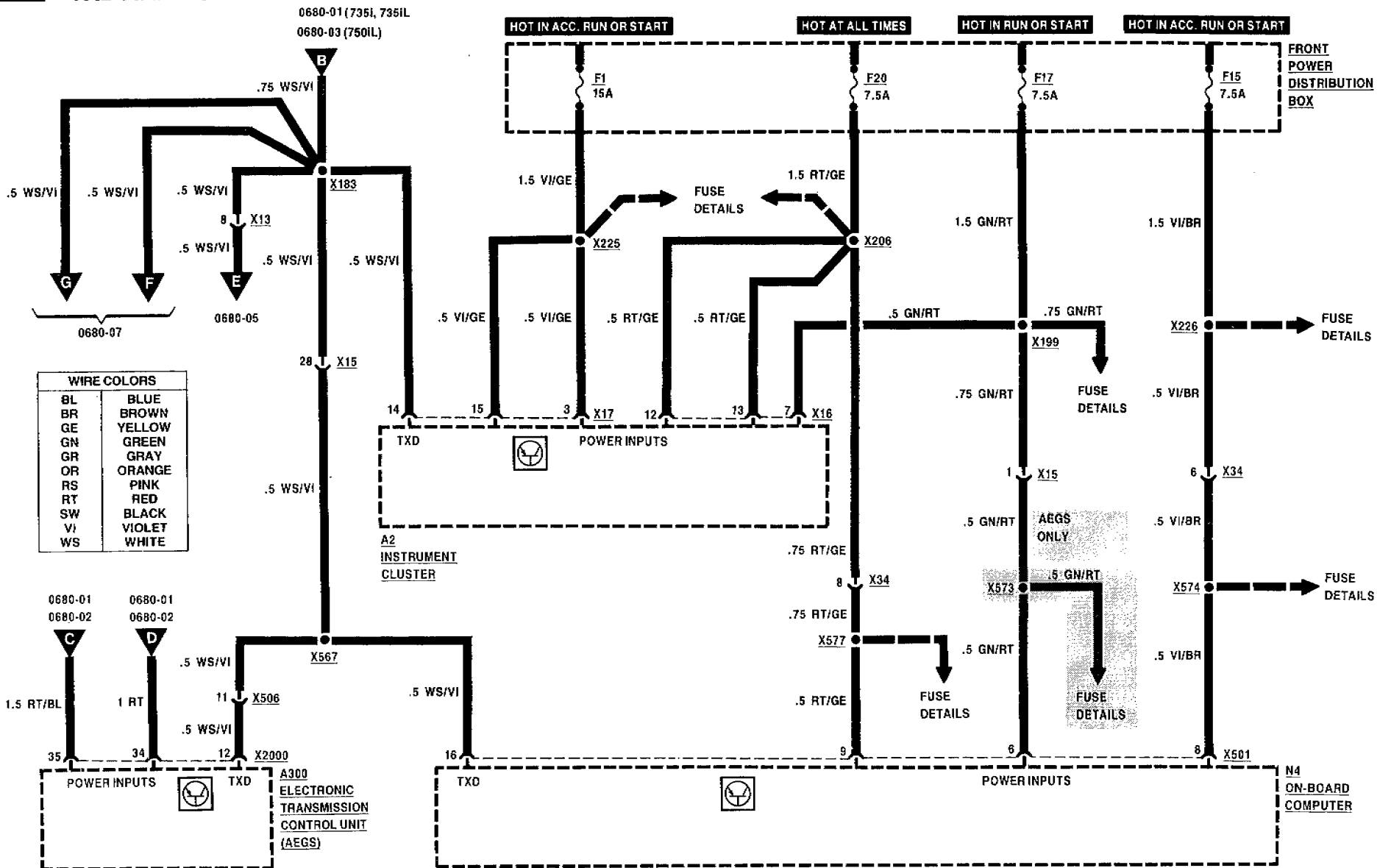



DIAGNOSTIC LINK TXD AND POWER

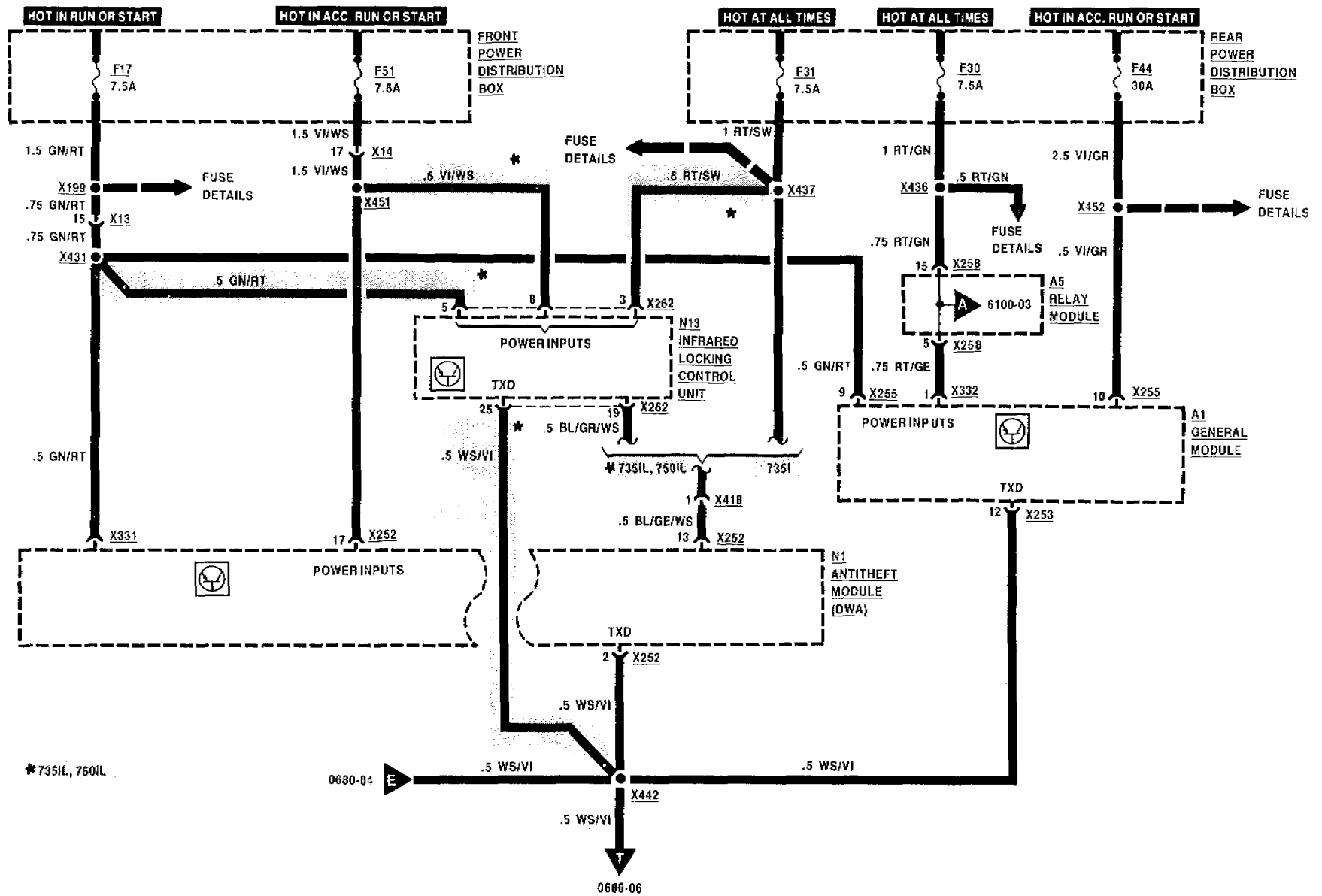



DIAGNOSTIC LINK

TXD AND POWER

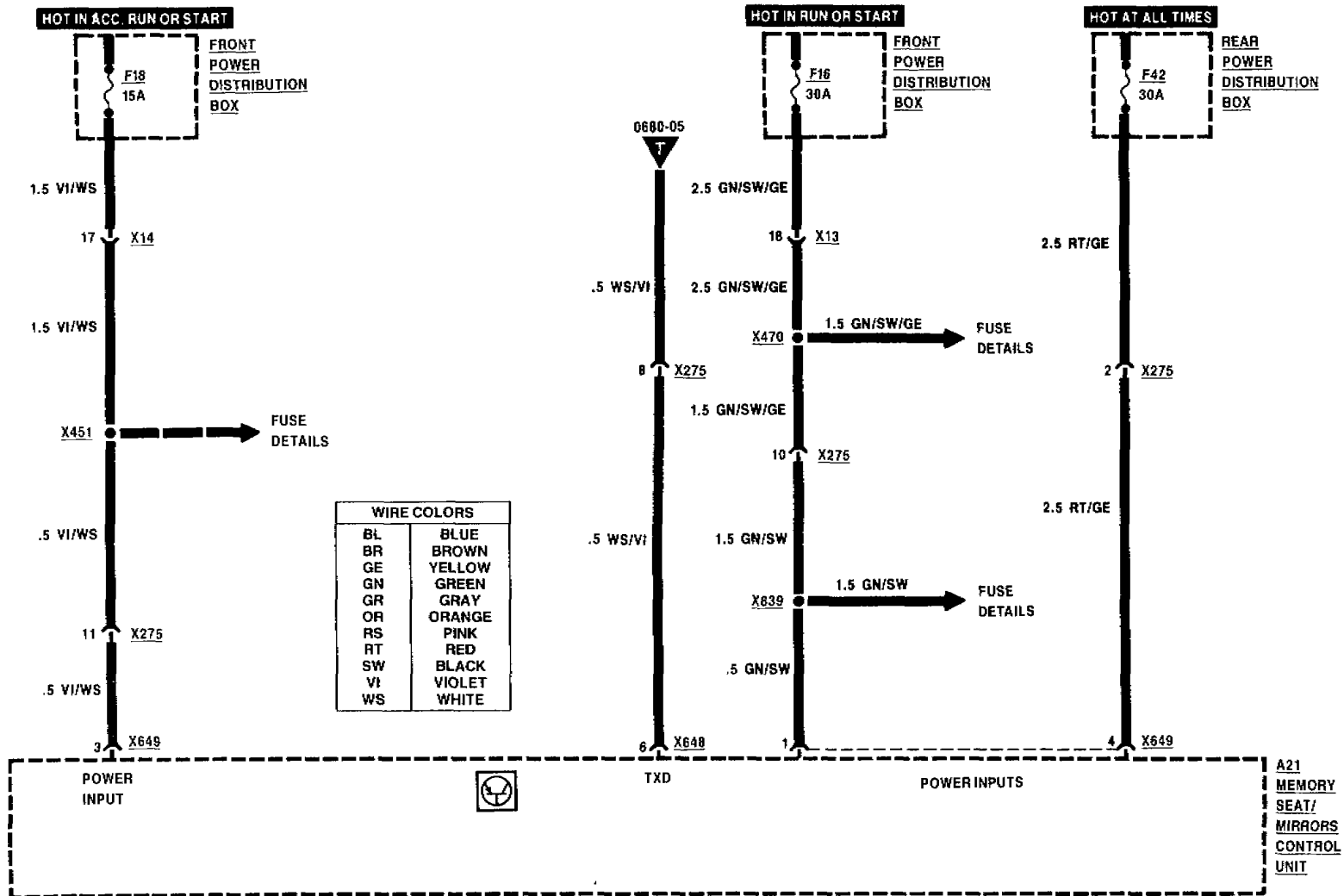



DIAGNOSTIC LINK

TXD AND POWER

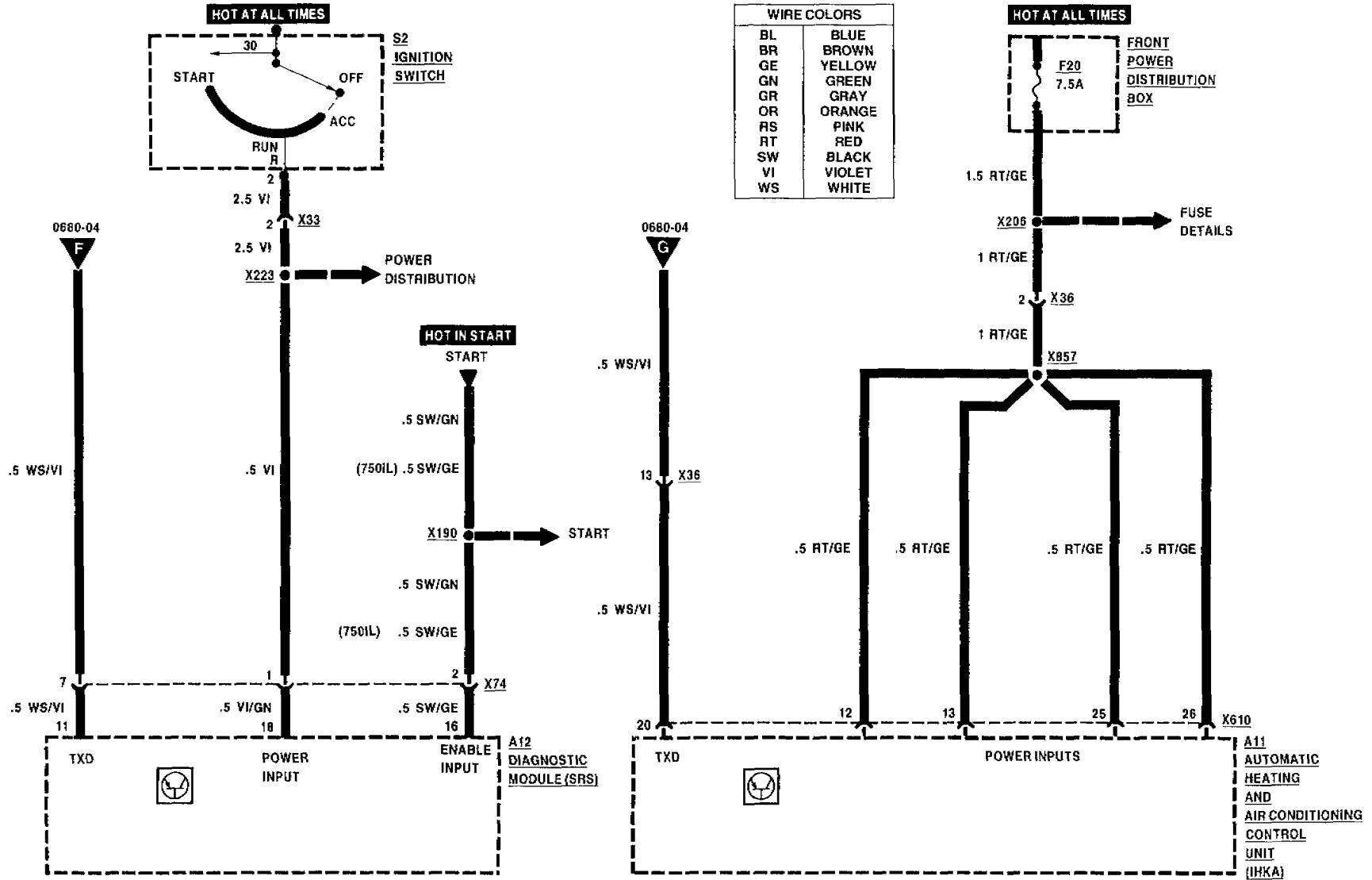



DIAGNOSTIC LINK

RXD AND GROUNDS

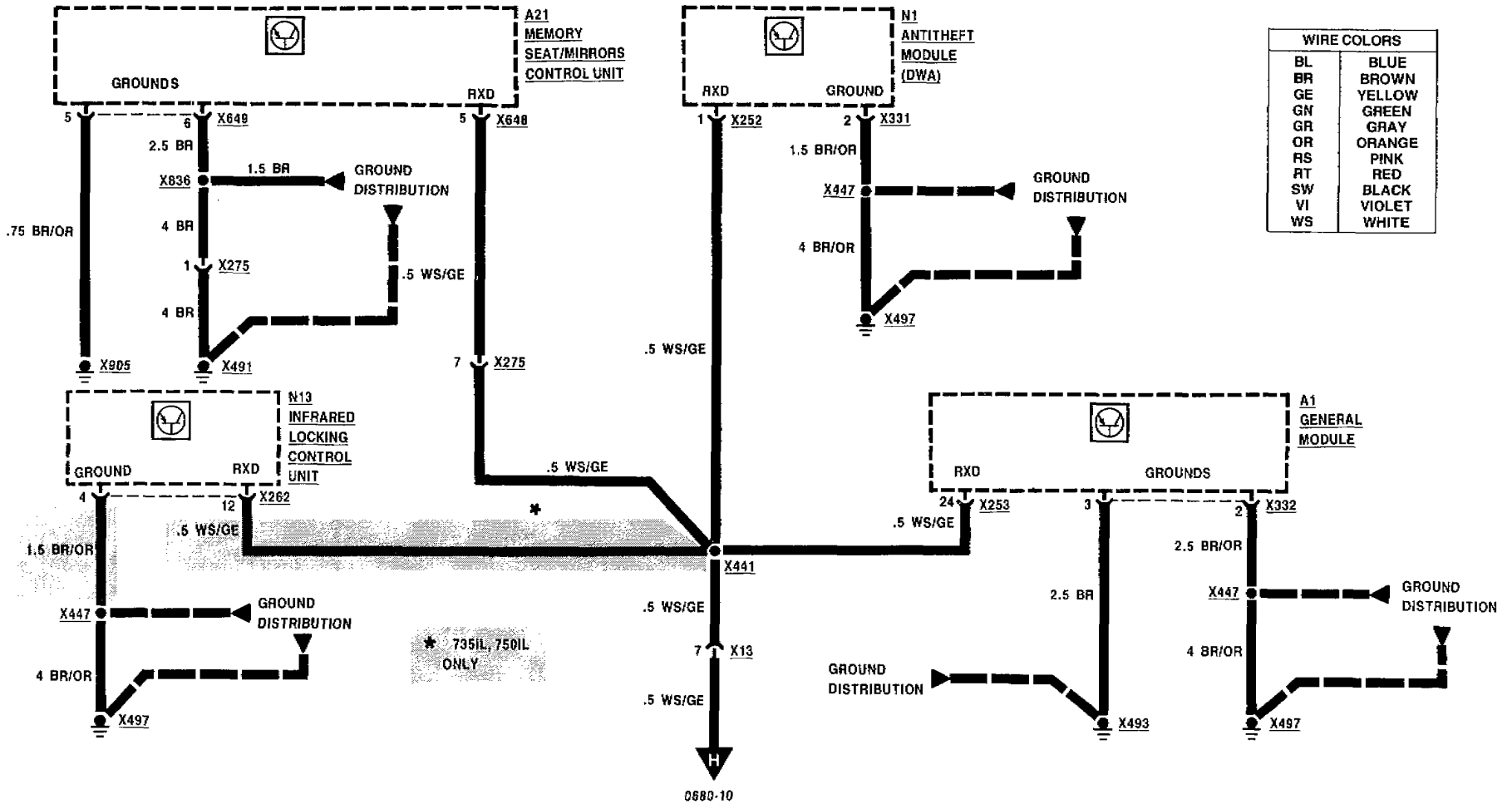



DIAGNOSTIC LINK

RXD AND GROUNDS

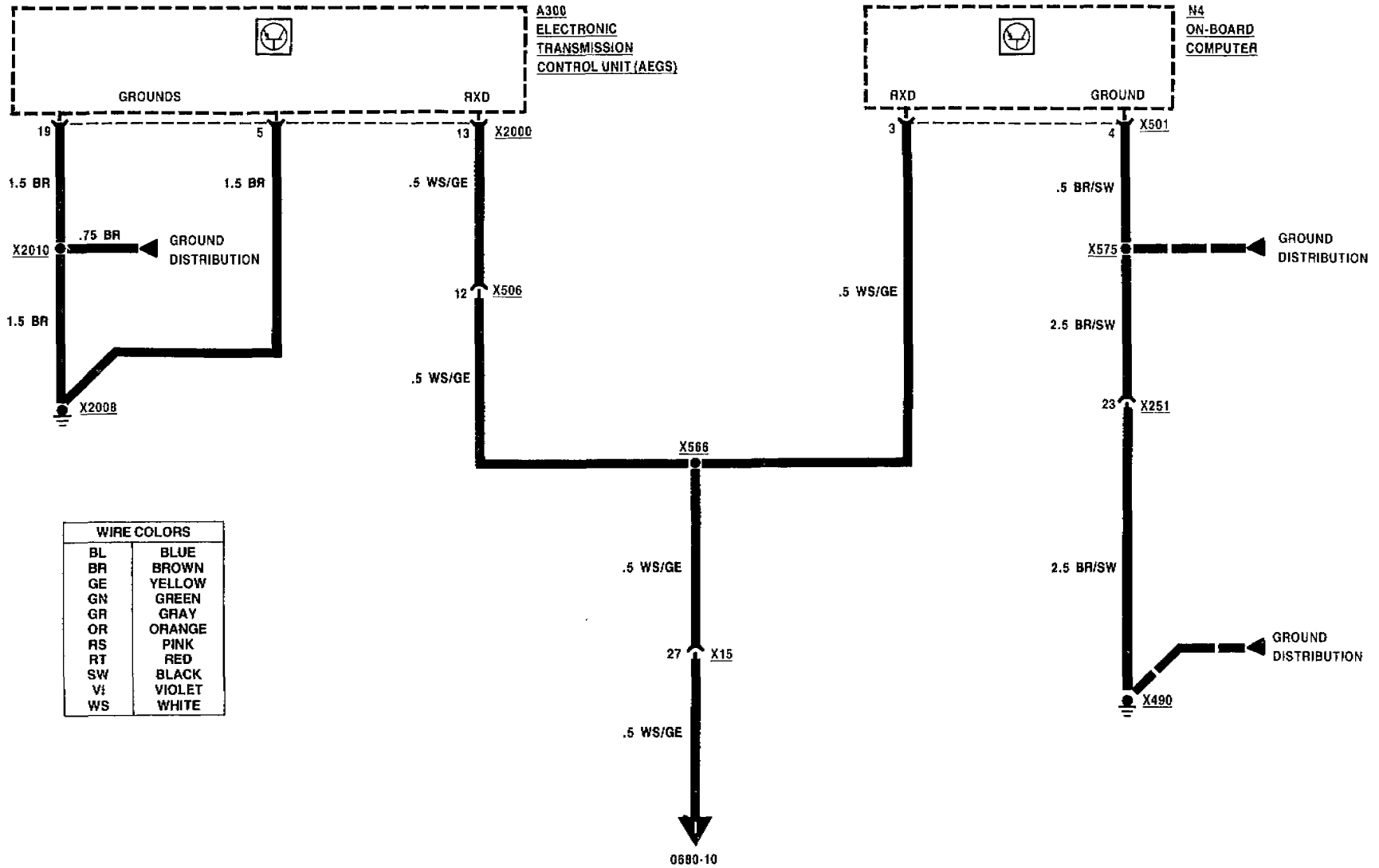



DIAGNOSTIC LINK RXD AND GROUNDS

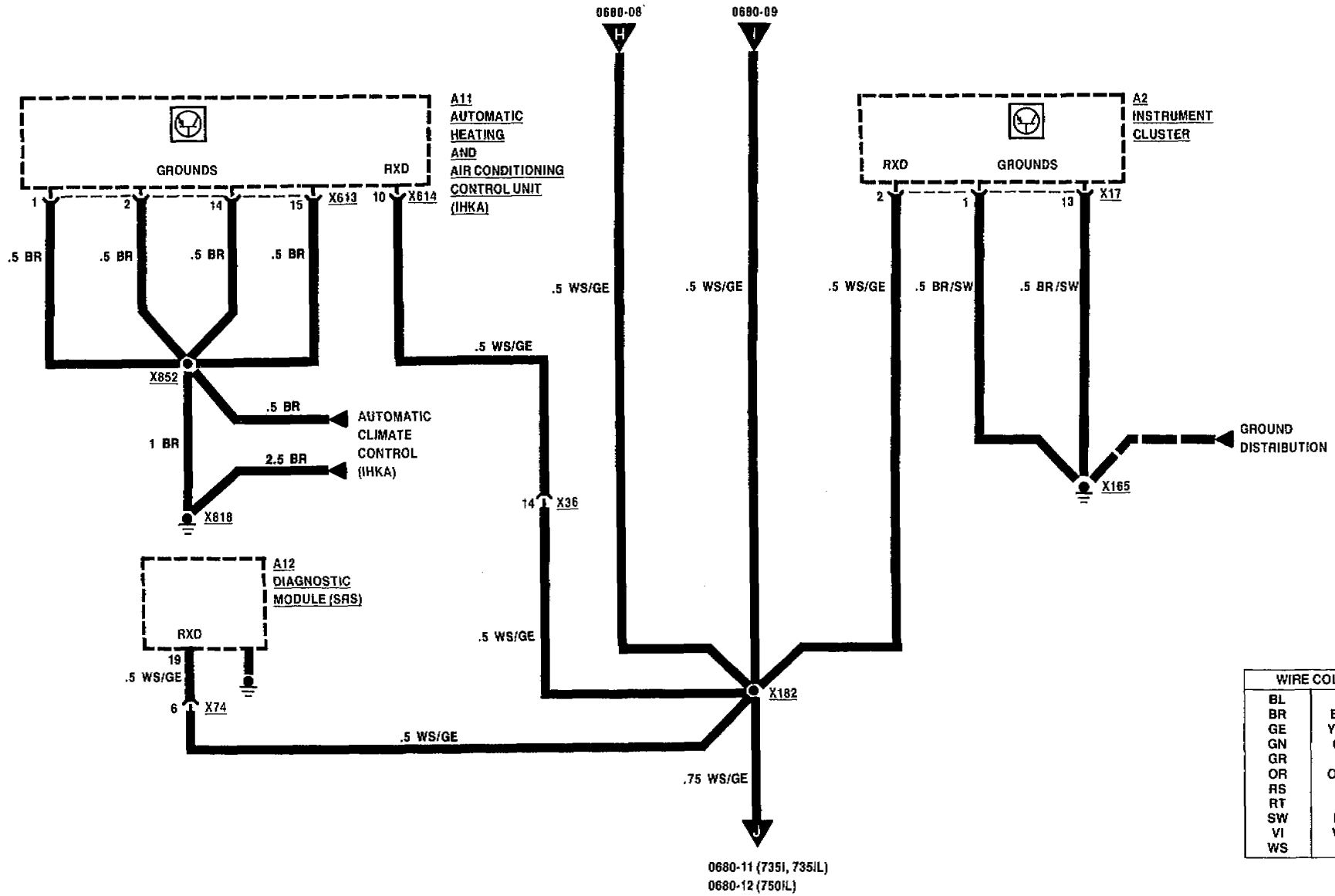



DIAGNOSTIC LINK RXD AND GROUNDS

735i, 735iL

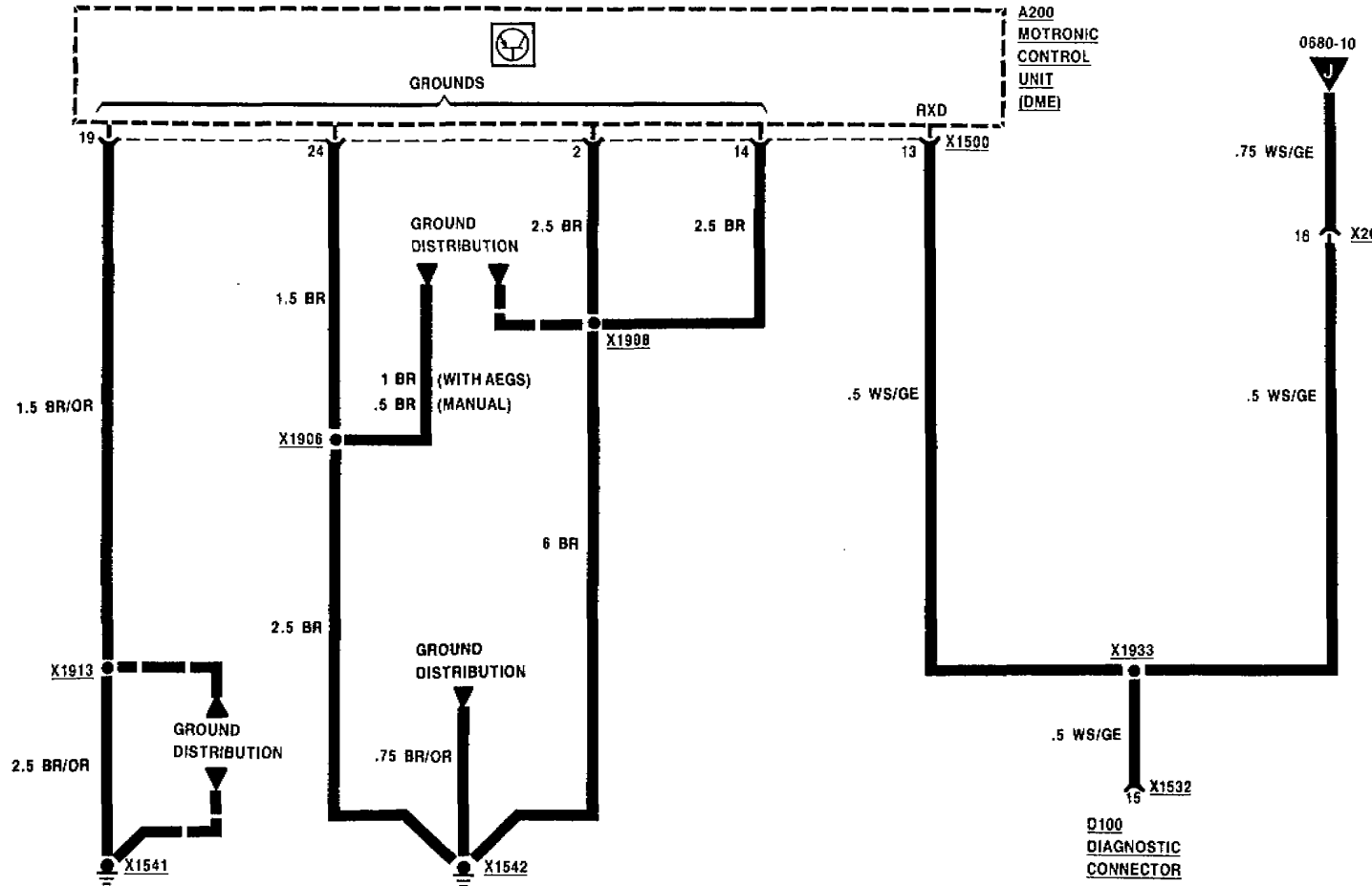

WIRE COLORS	
BL	BLUE
BR	BROWN
GE	YELLOW
GN	GREEN
GR	GRAY
OR	ORANGE
RS	PINK
RT	RED
SW	BLACK
VI	VIOLET
WS	WHITE



DIAGNOSTIC LINK RXD AND GROUNDS

750iL

WIRE COLORS	
BL	BLUE
BR	BROWN
GE	YELLOW
GN	GREEN
GR	GRAY
OR	ORANGE
RS	PINK
RT	RED
SW	BLACK
VI	VIOLET
WS	WHITE

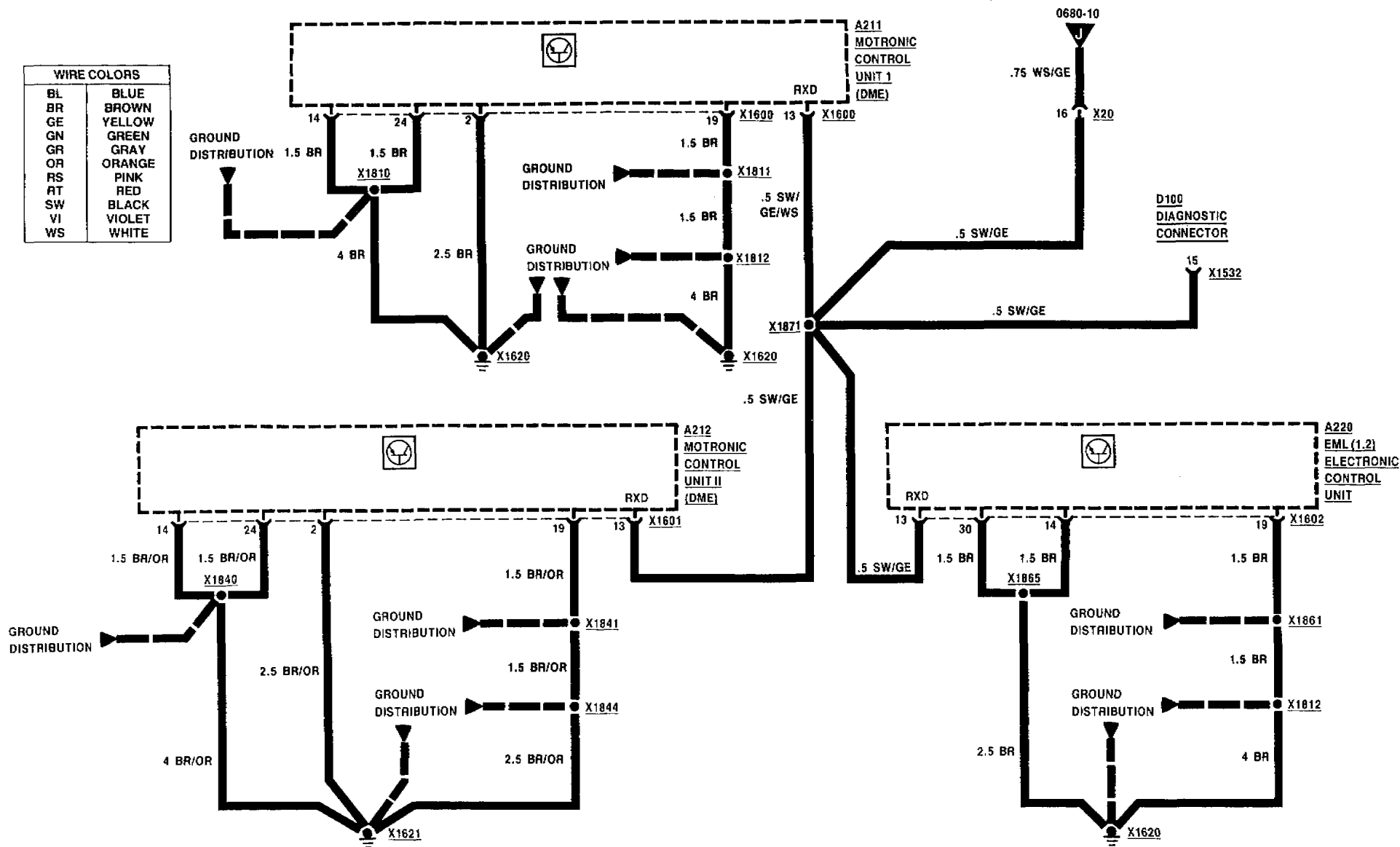

09/88

0680-12

1989

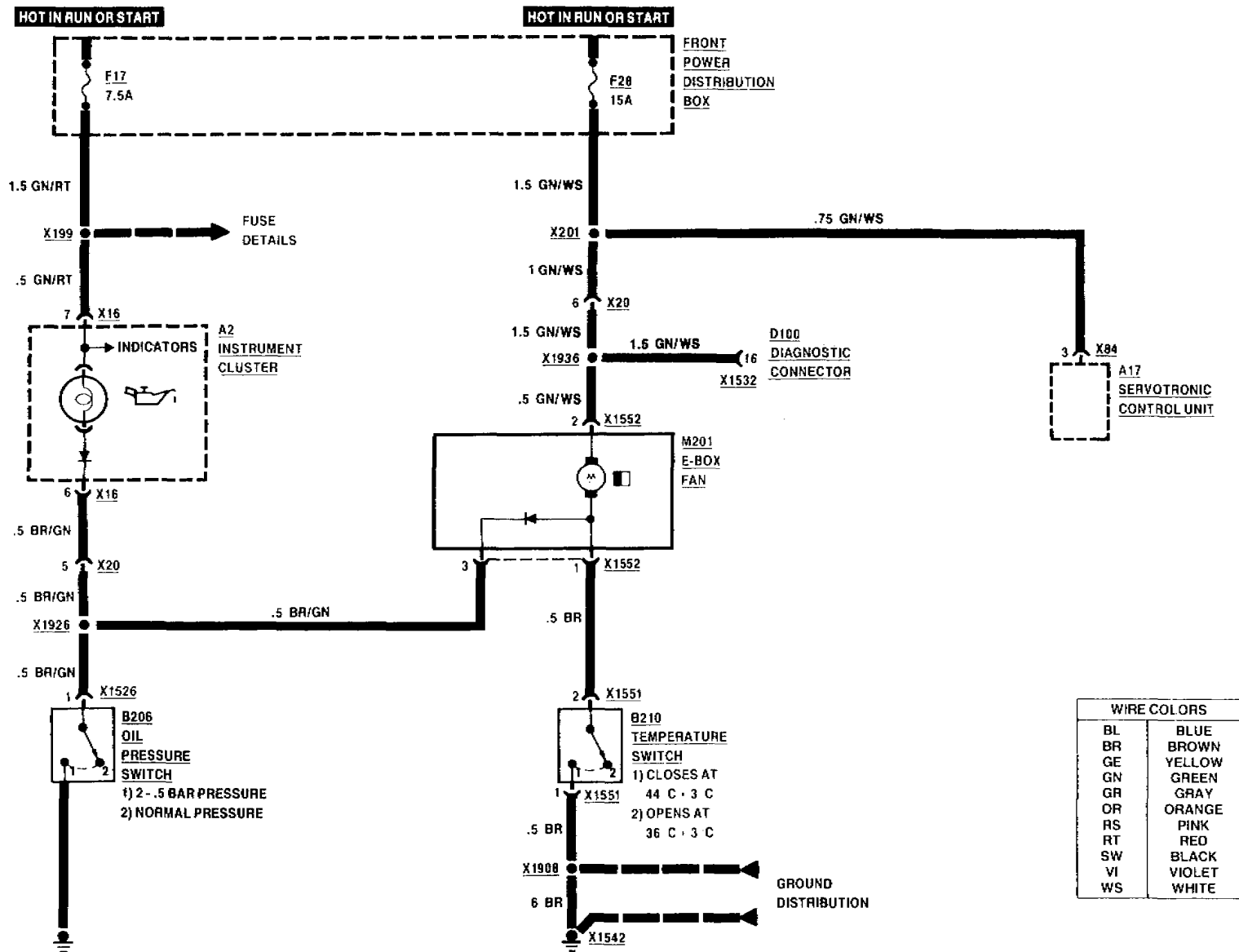

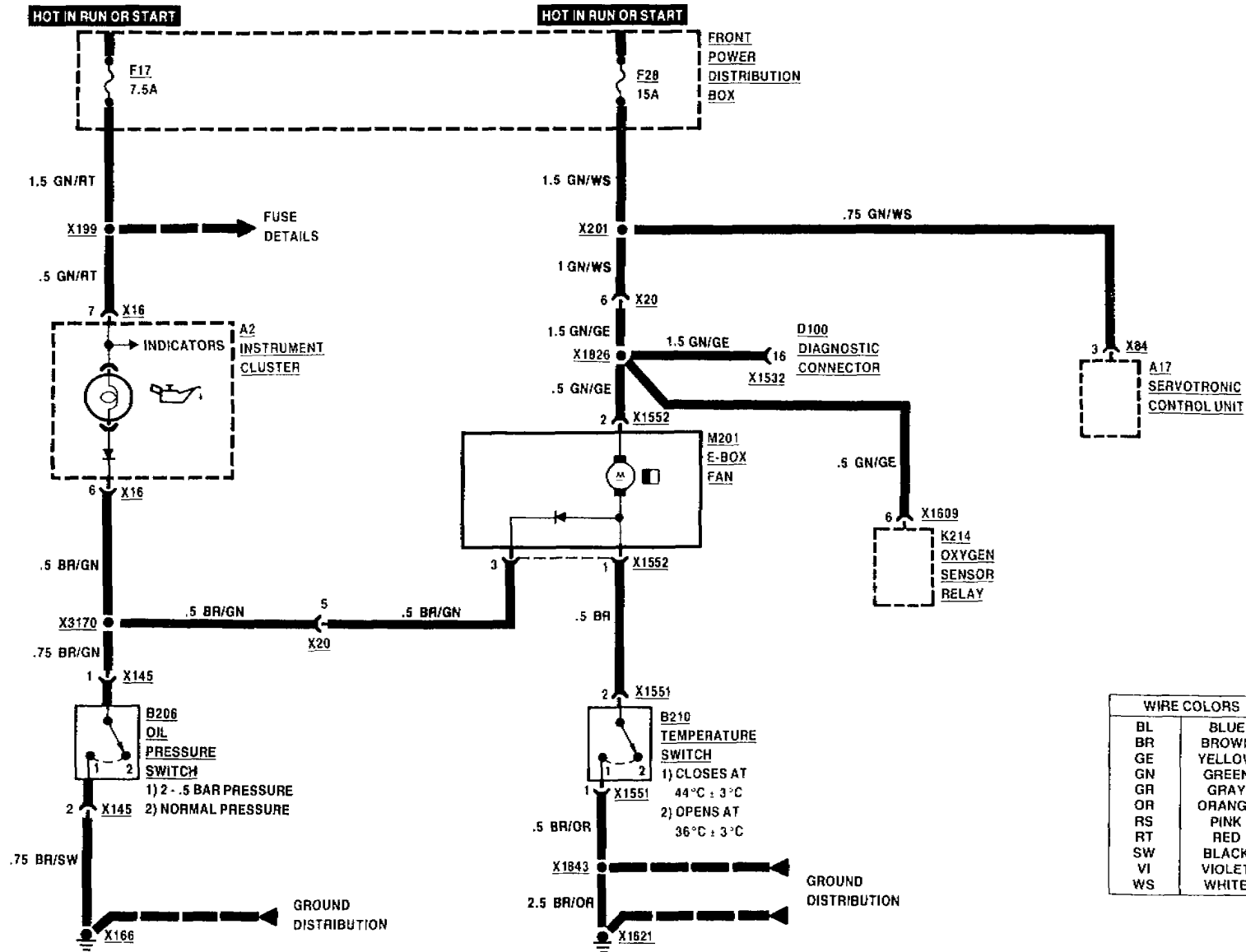

WIRE COLORS	
BL	BLUE
BR	BROWN
GE	YELLOW
GN	GREEN
GR	GRAY
OR	ORANGE
RS	PINK
RT	RED
SW	BLACK
VI	VIOLET
WS	WHITE



CHARGING SYSTEM

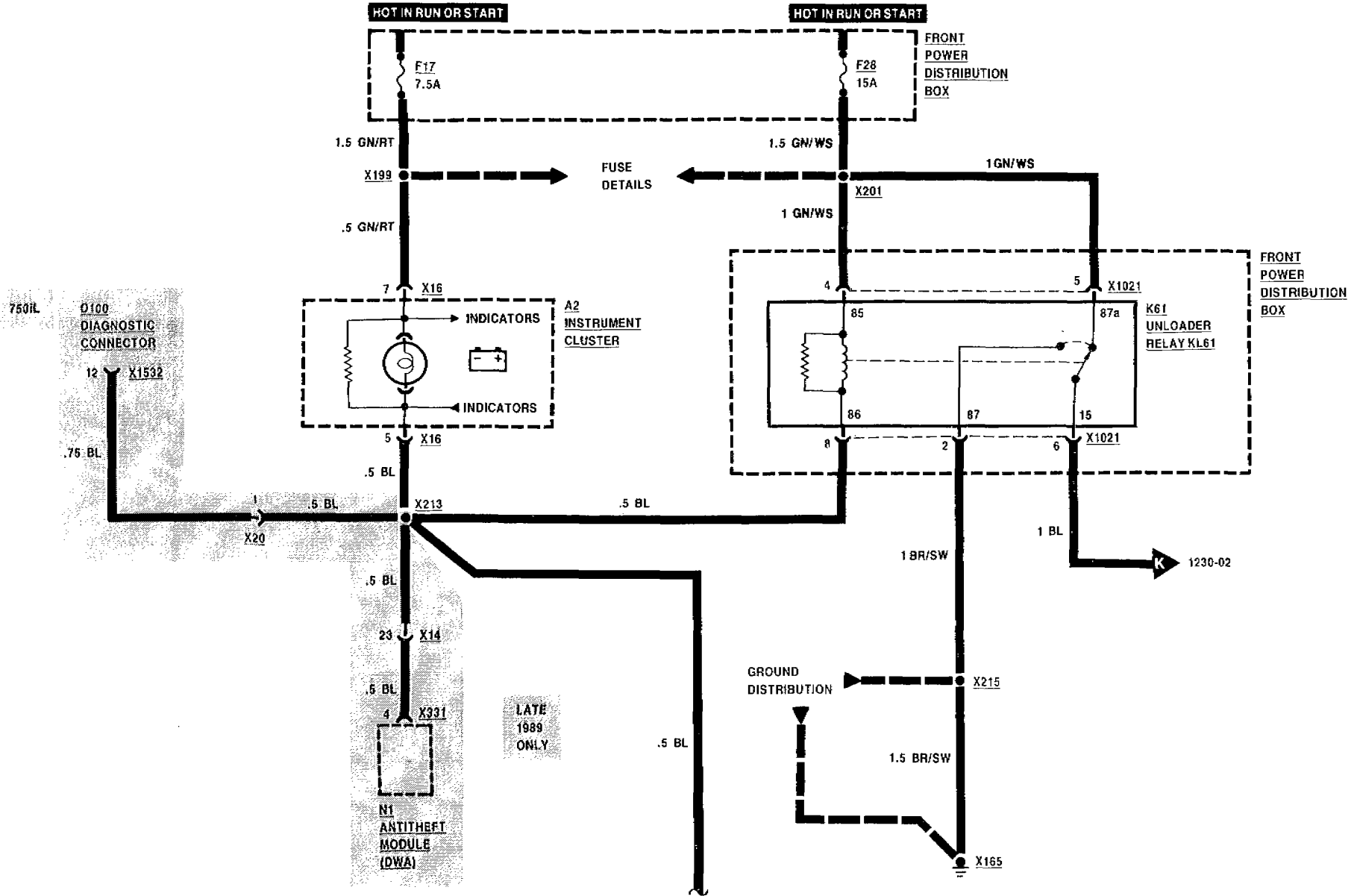

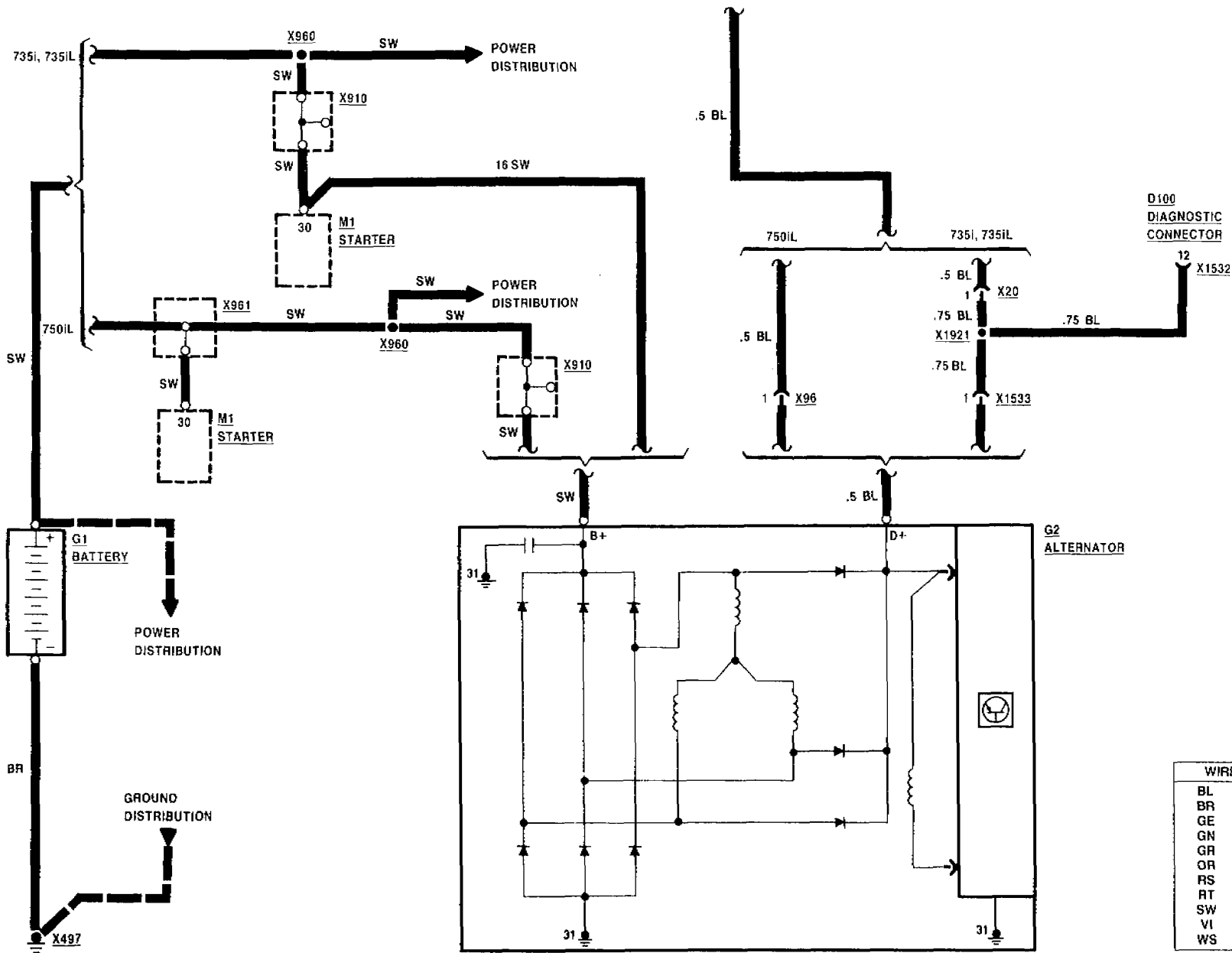



CHARGING SYSTEM

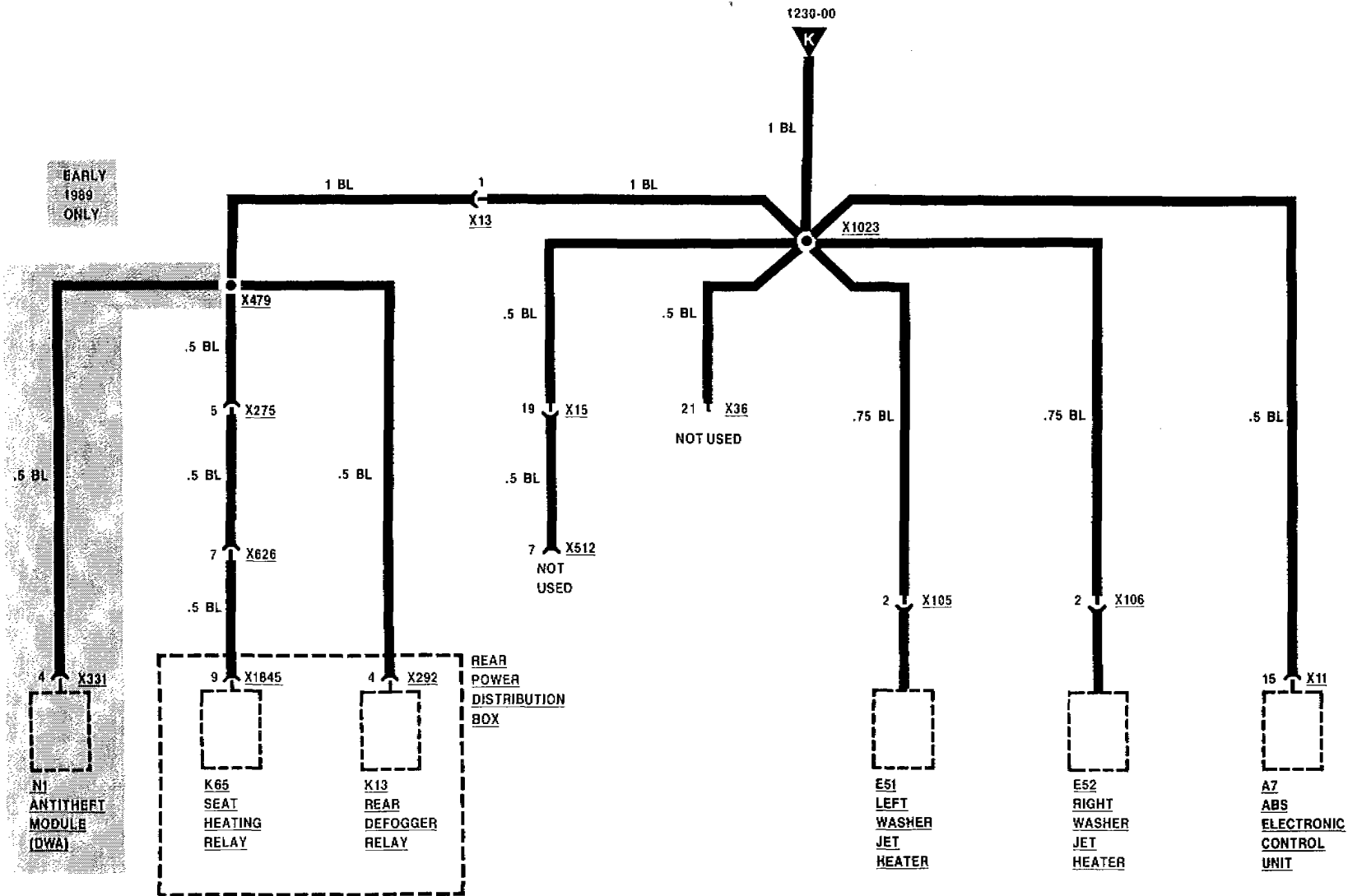



START

735i, 735iL

11/89

1240-00

1989

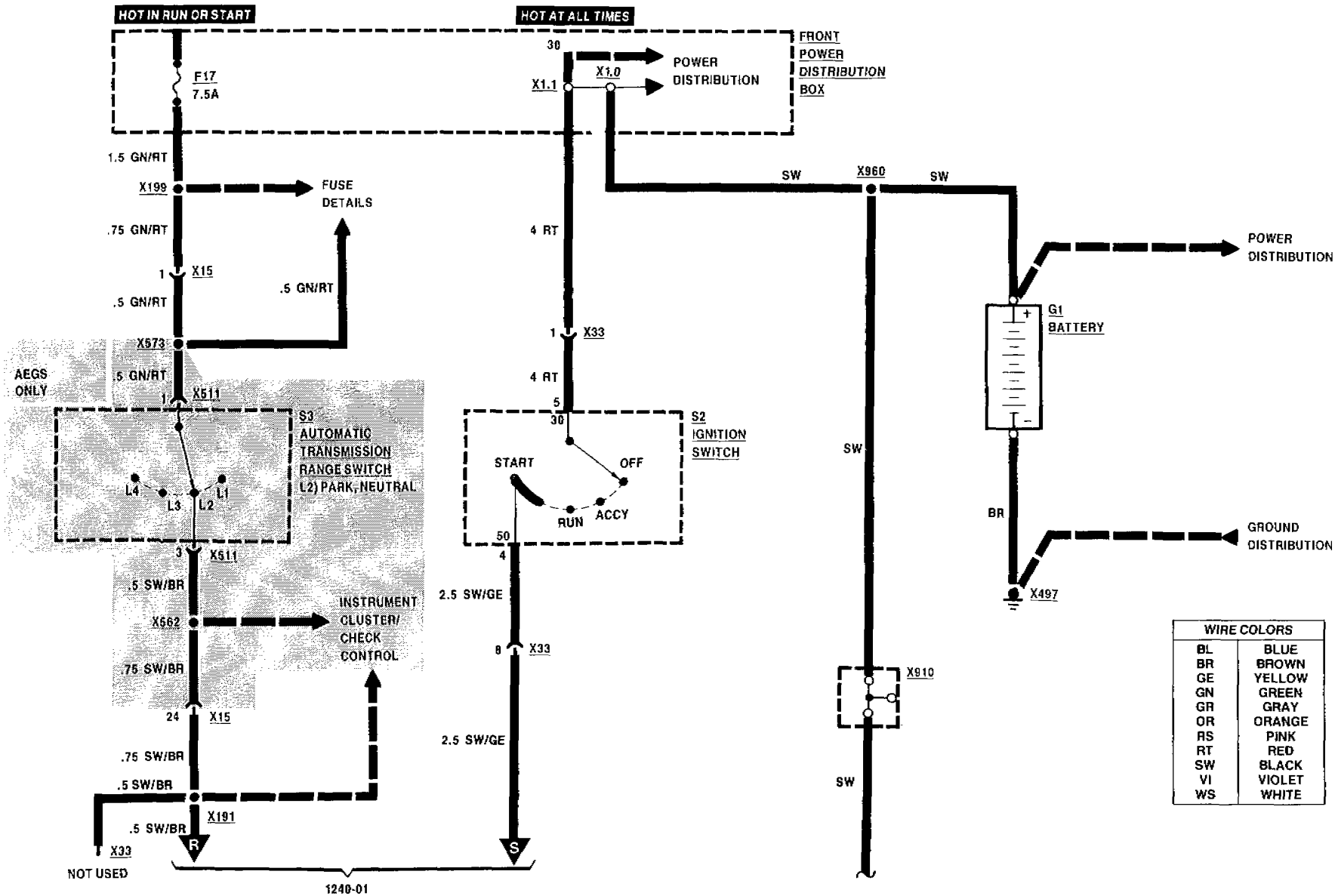

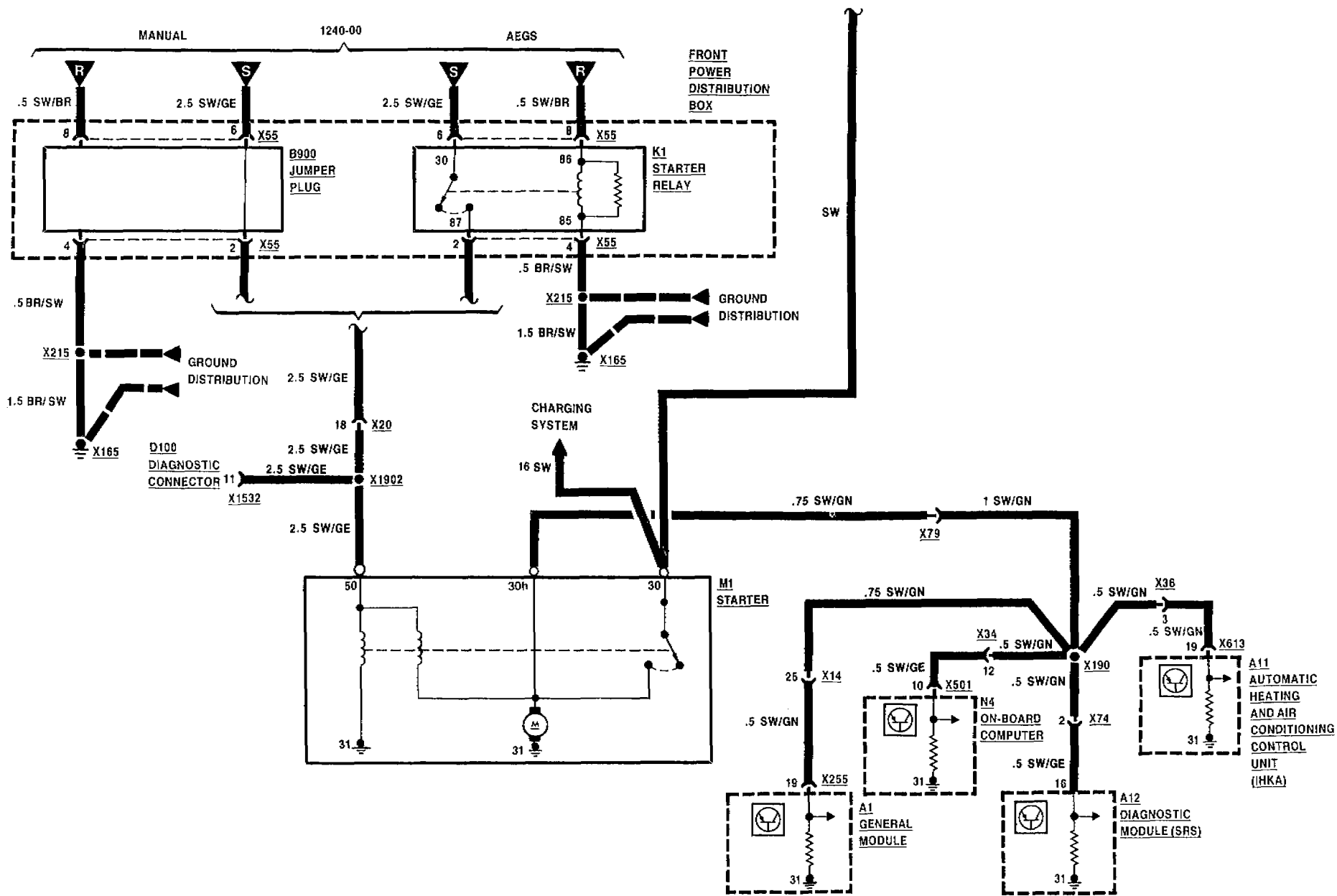

11 / 89 — 1240-01 — 1989



START

750iL

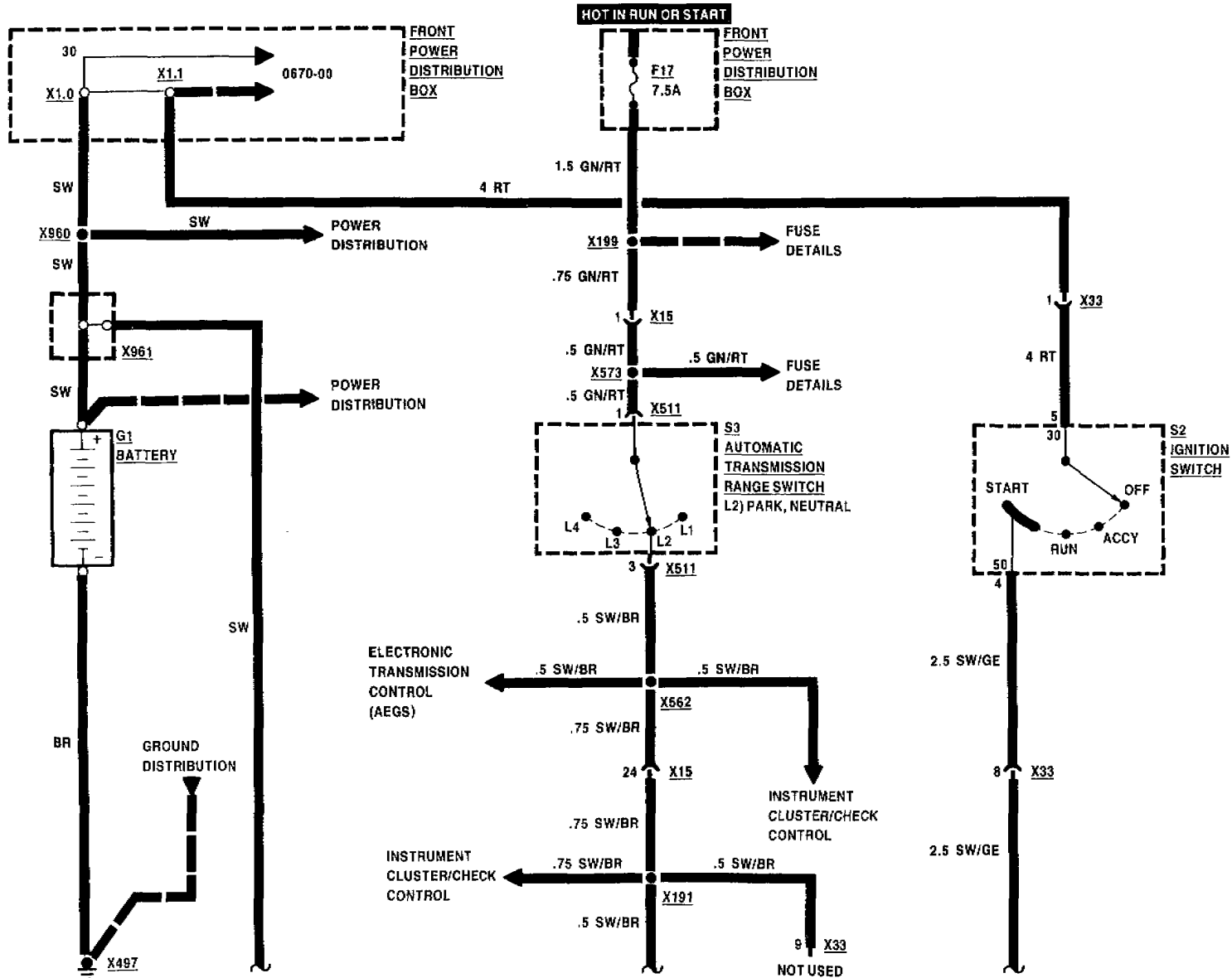

WIRE COLORS	
BL	BLUE
BR	BROWN
GE	YELLOW
GN	GREEN
GR	GRAY
OR	ORANGE
RS	PINK
RT	RED
SW	BLACK
VI	VIOLET
WS	WHITE

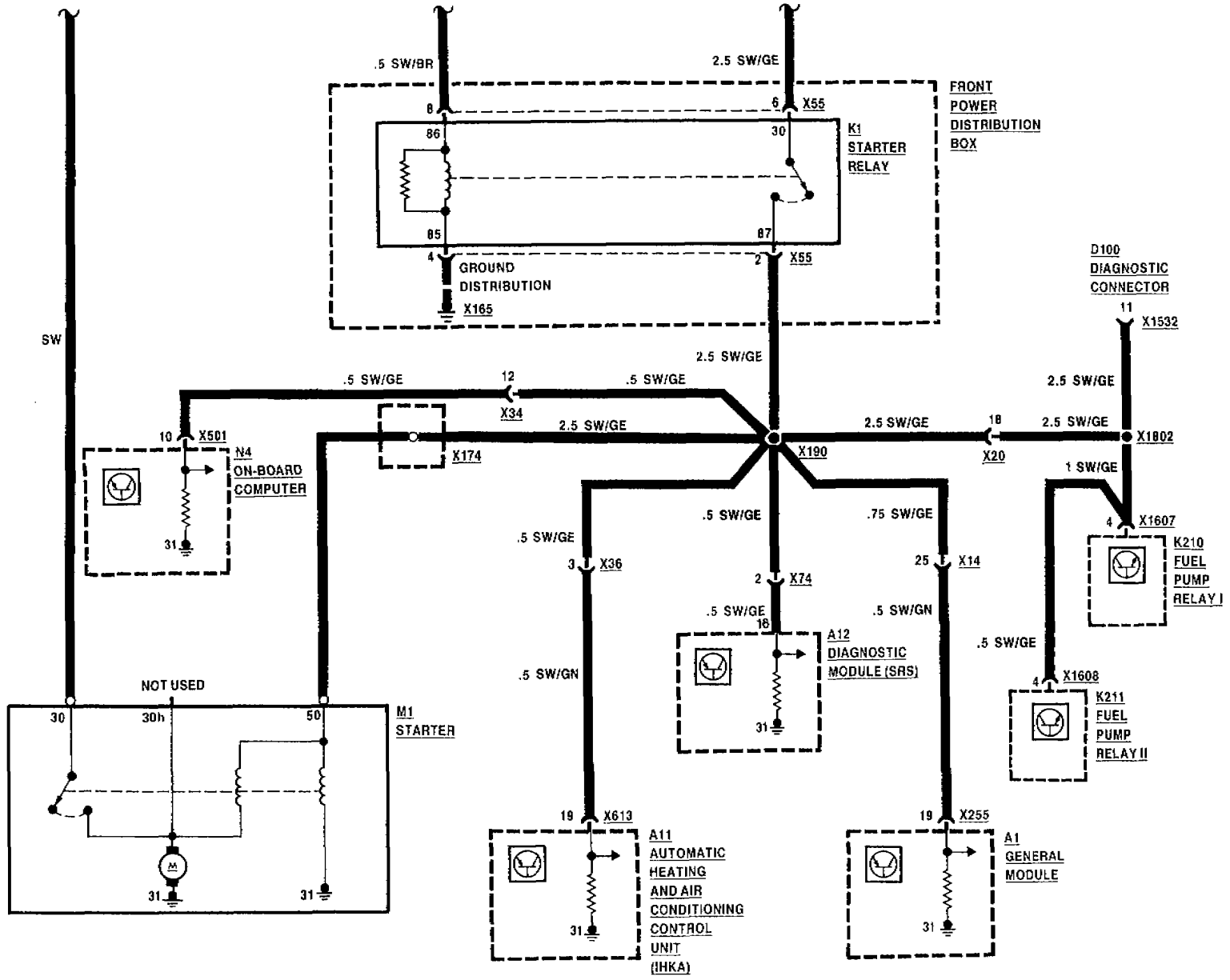

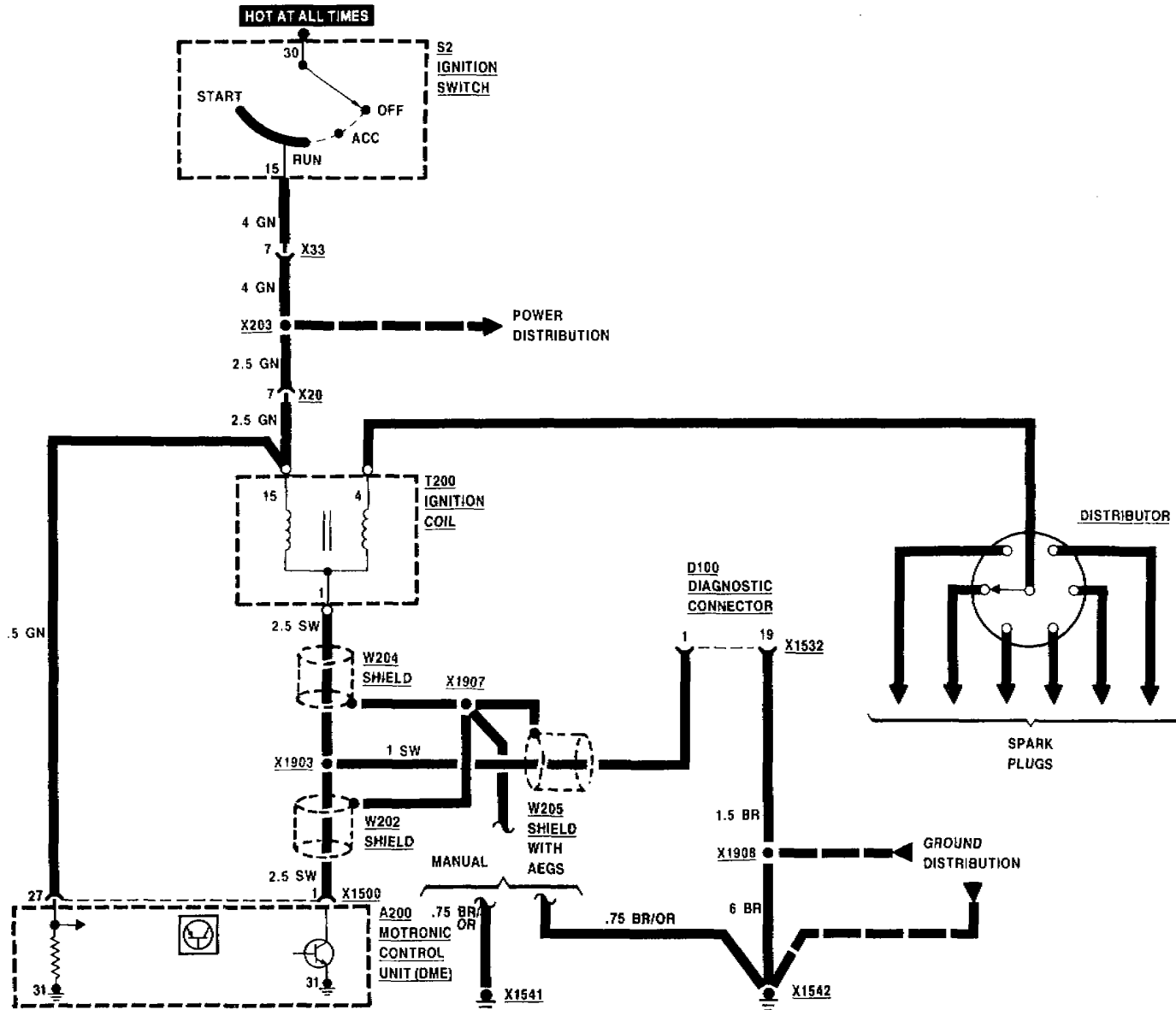

WIRE COLORS	
BL	BLUE
BR	BROWN
GE	YELLOW
GN	GREEN
GR	GRAY
OR	ORANGE
RS	PINK
RT	RED
SW	BLACK
VI	VIOLET
WS	WHITE



INJECTION ELECTRONICS (DME 1.3)

735i, 735iL

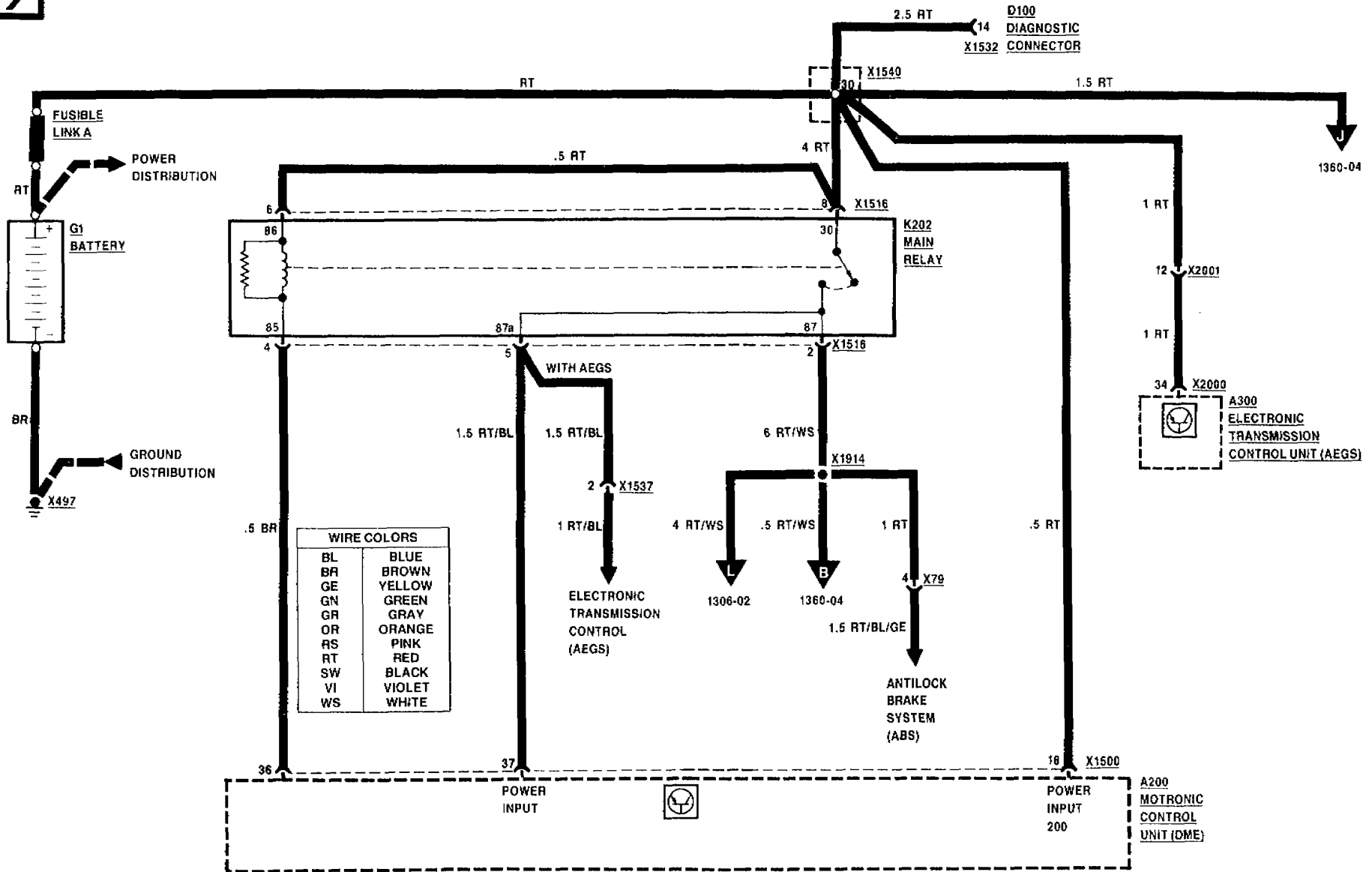



INJECTION ELECTRONICS (DME 1.3)

FUEL INJECTORS

735i, 735iL

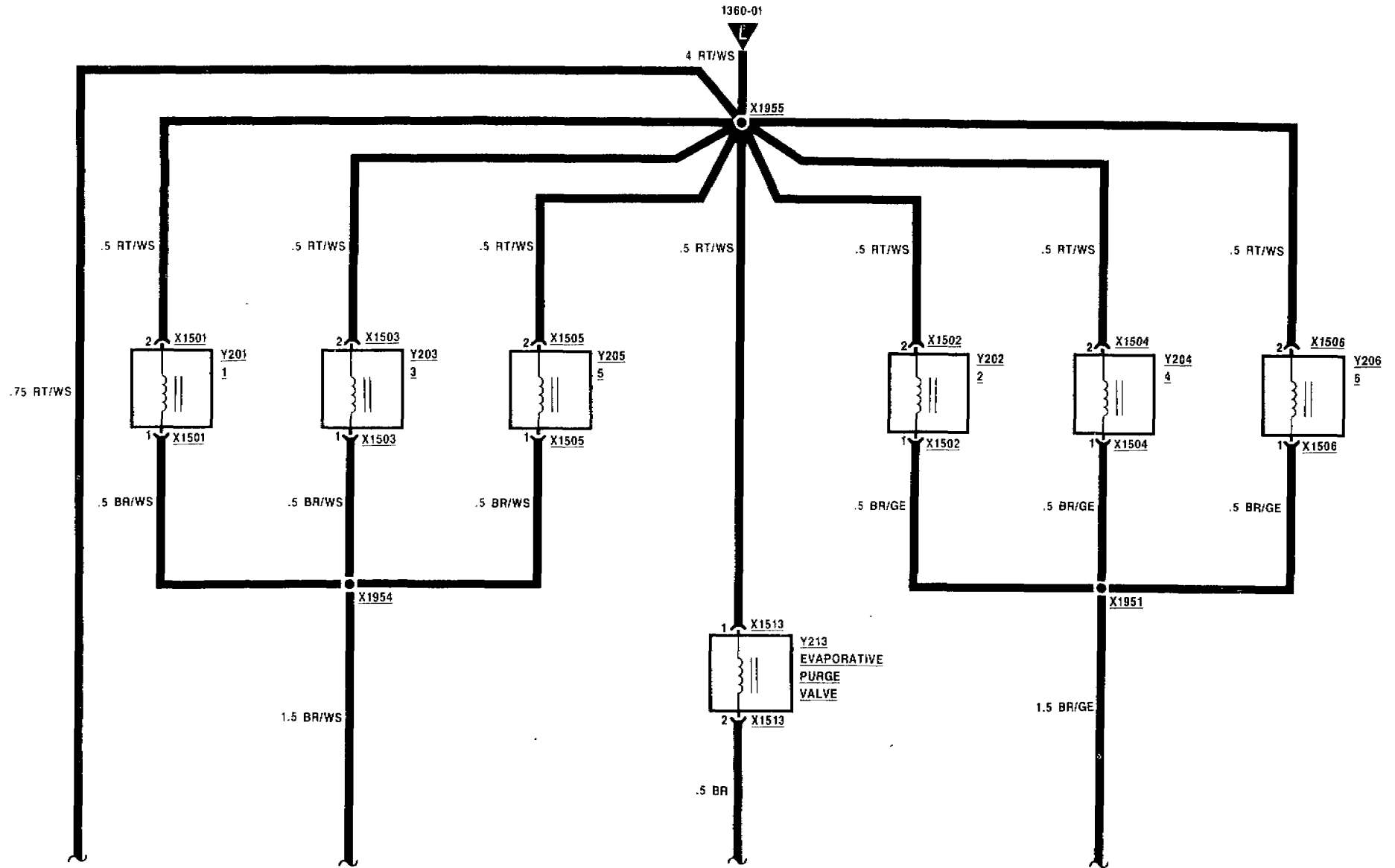

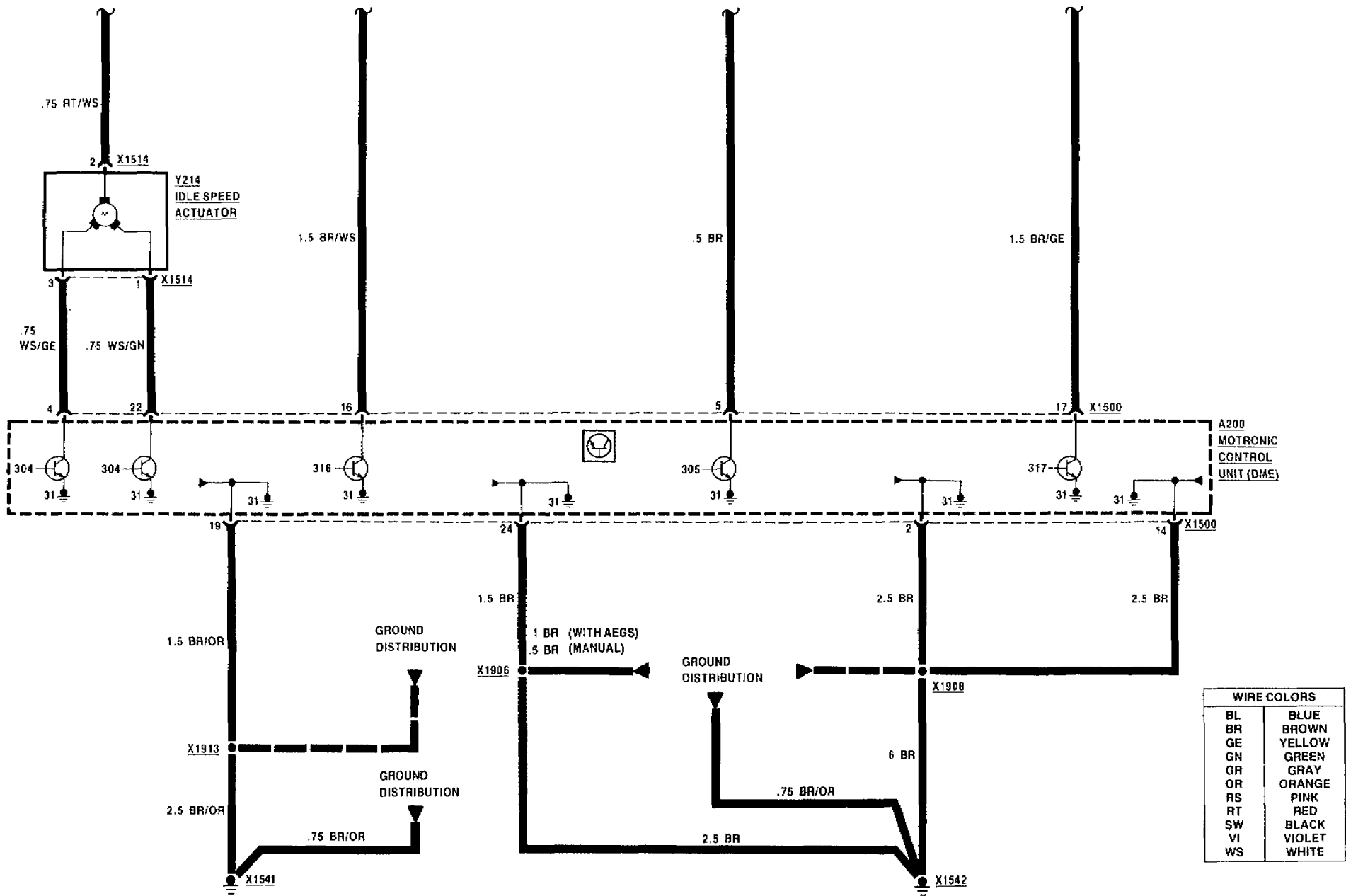

WIRE COLORS	
BL	BLUE
BR	BROWN
GE	YELLOW
GN	GREEN
GR	GRAY
OR	ORANGE
RS	PINK
RT	RED
SW	BLACK
VI	VIOLET
WS	WHITE



INJECTION ELECTRONICS (DME 1.3)

735i, 735iL

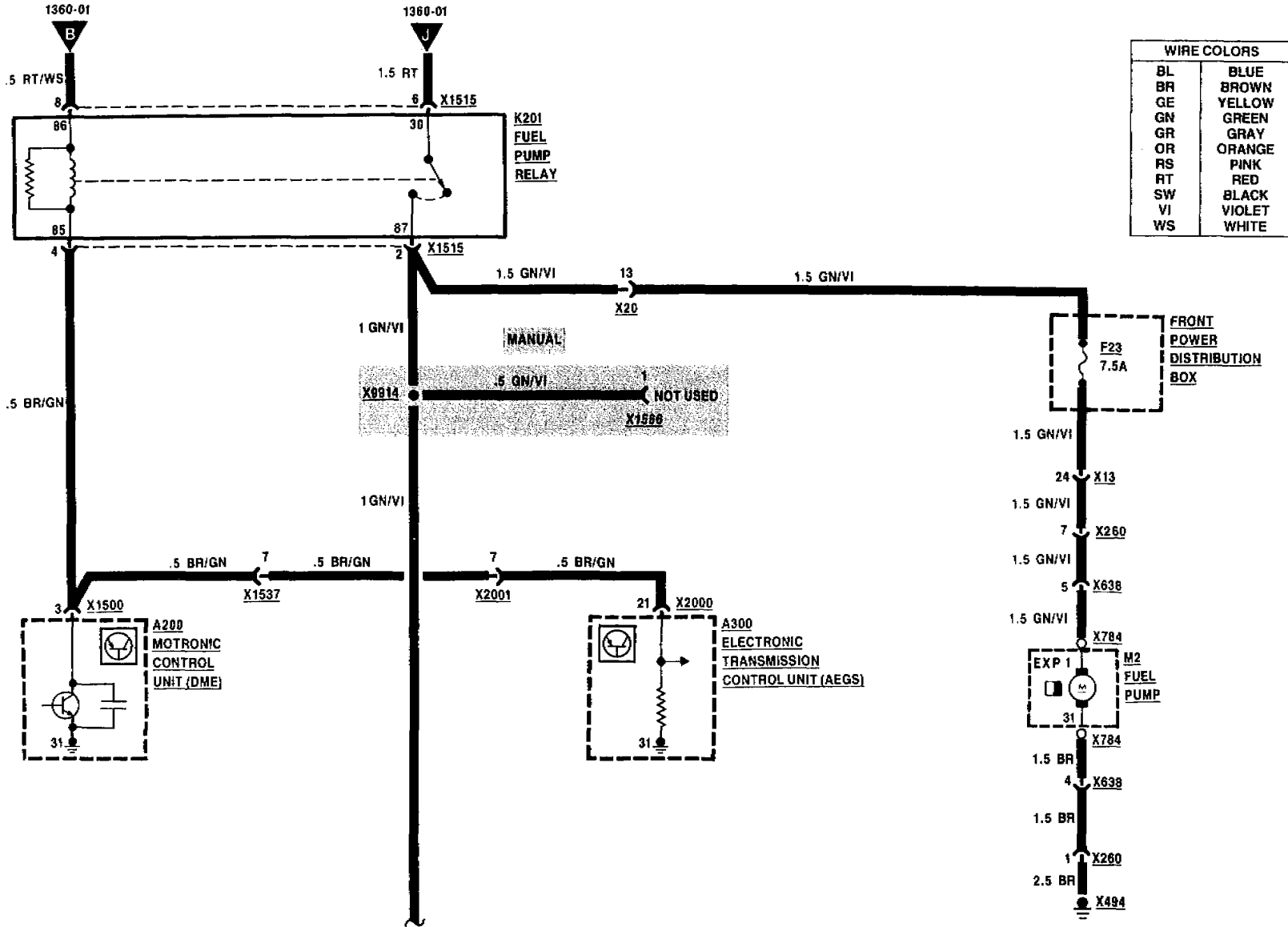

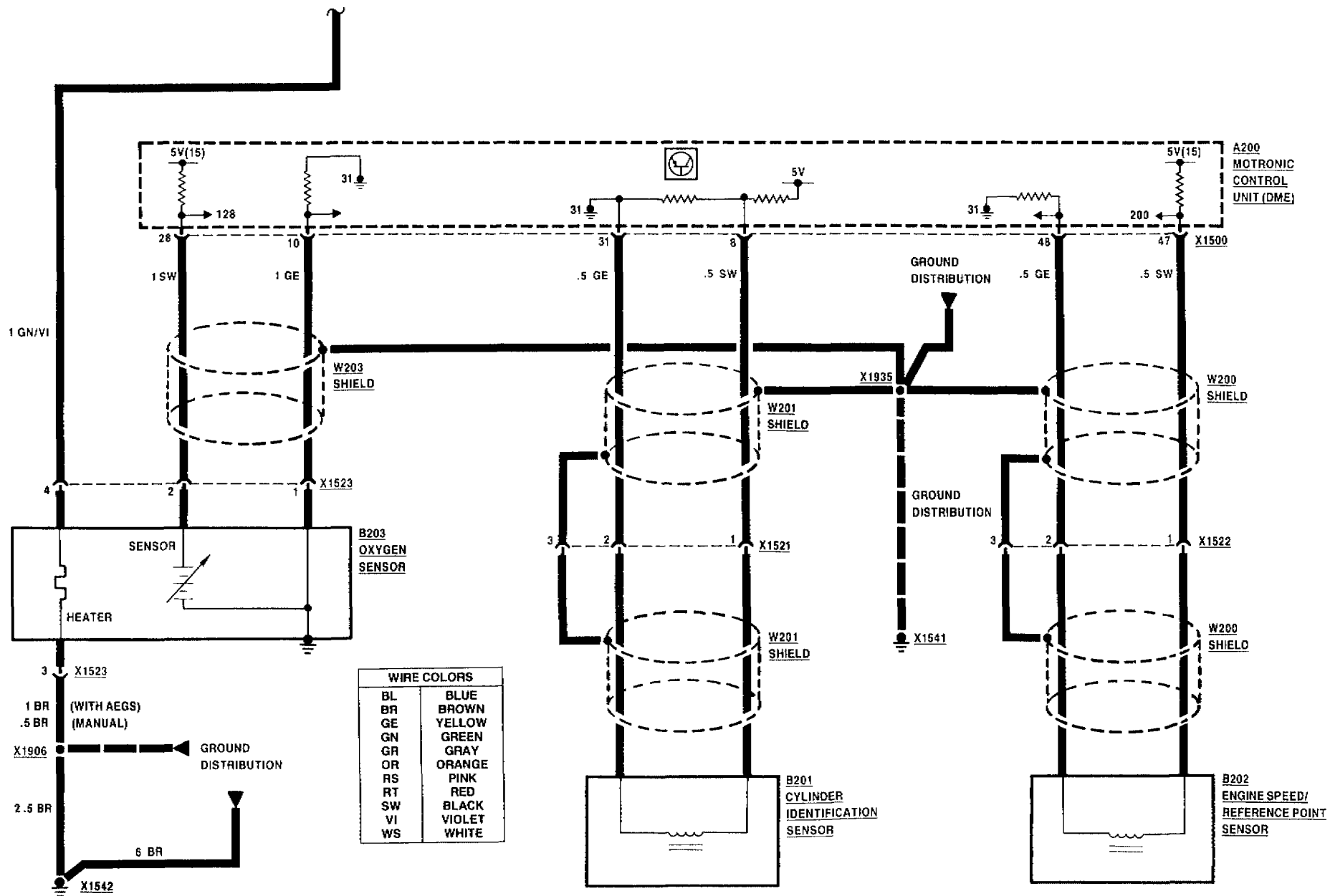



INJECTION ELECTRONICS (DME 1.3)

735i, 735iL

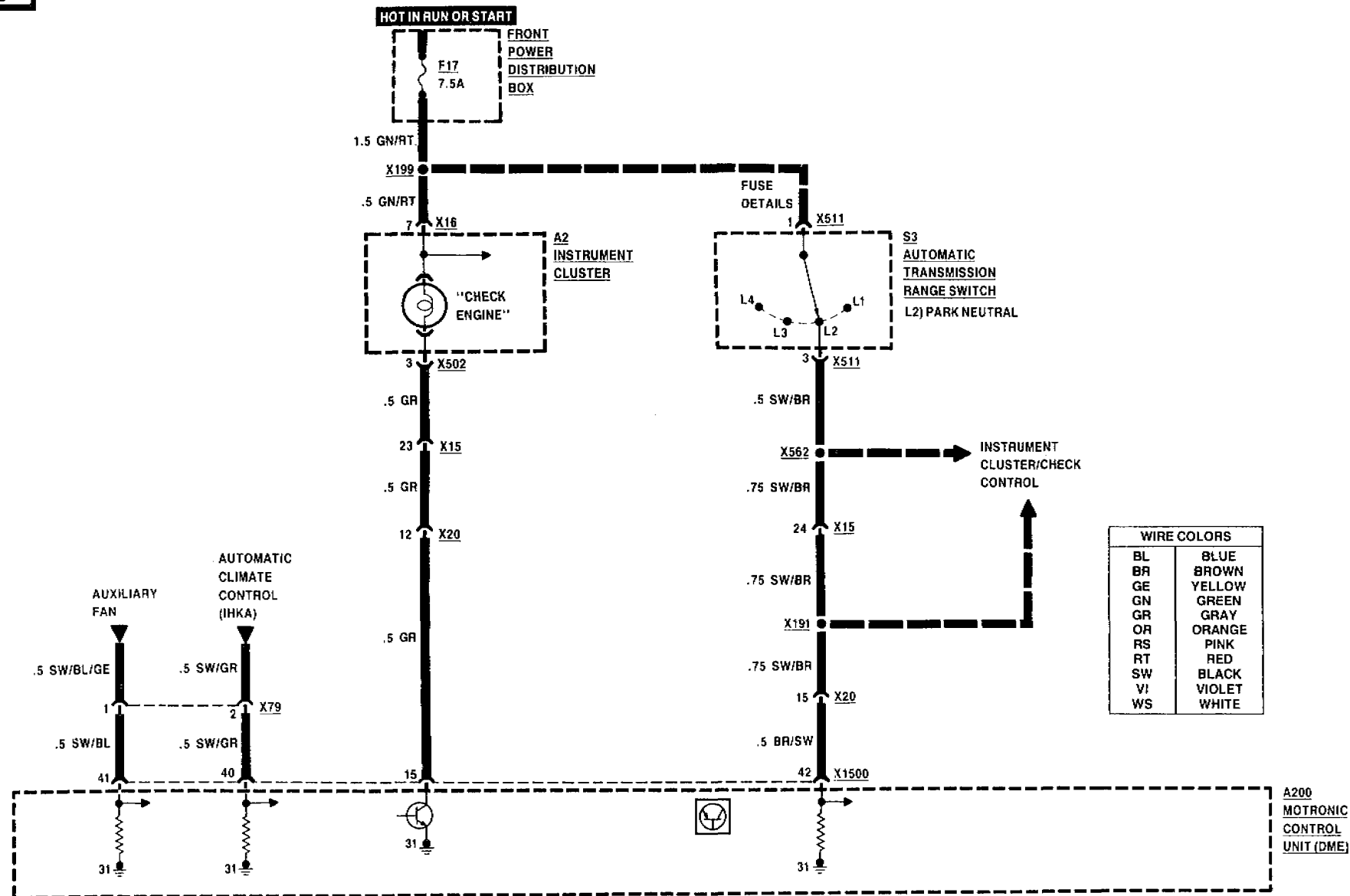



INJECTION ELECTRONICS (DME 1.3)

735i, 735iL

09/88

1360-07

1989

WIRE COLORS	
BL	BLUE
BR	BROWN
GE	YELLOW
GN	GREEN
GR	GRAY
OR	ORANGE
RS	PINK
RT	RED
SW	BLACK
VI	VIOLET
WS	WHITE

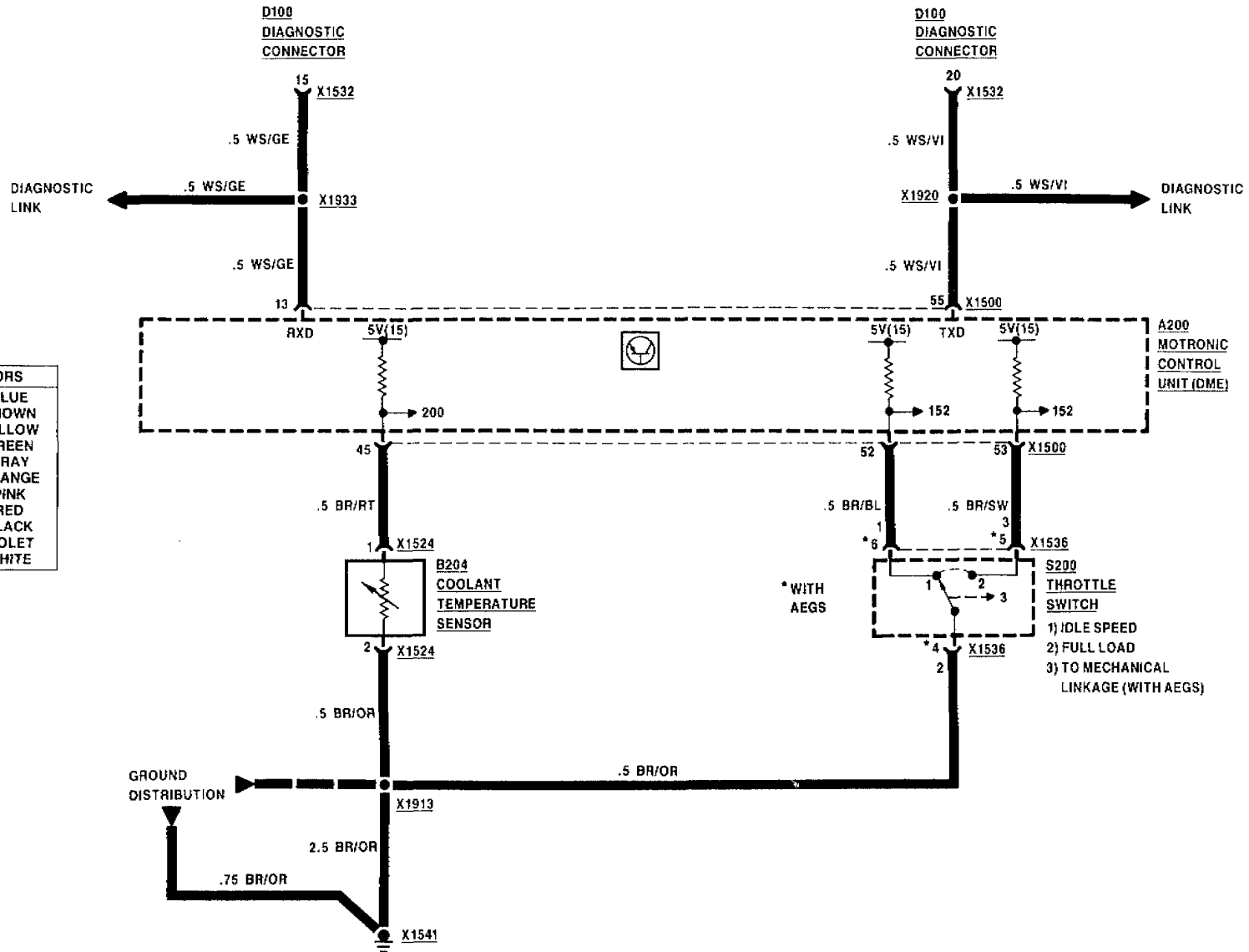

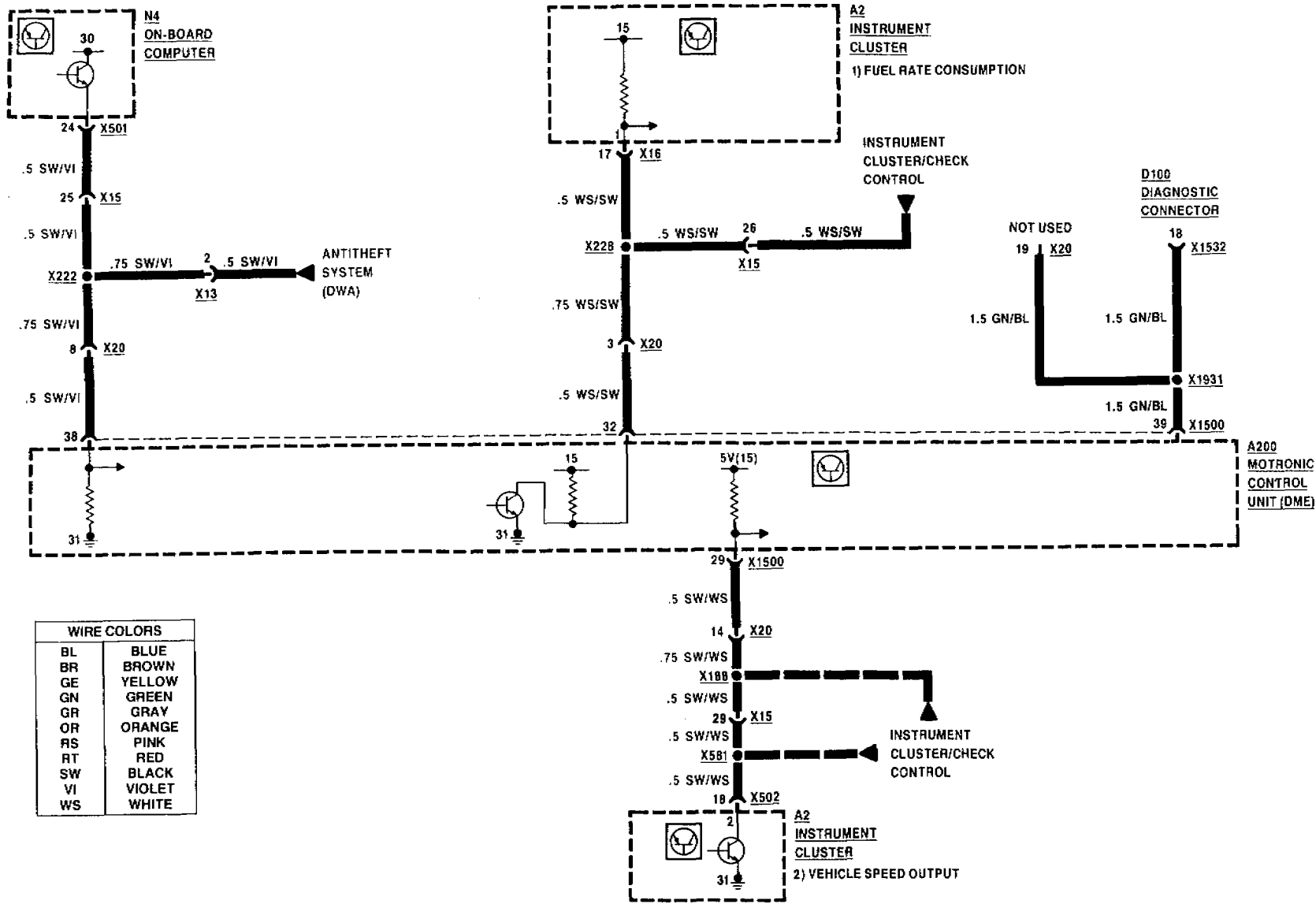

WIRE COLORS	
BL	BLUE
BR	BROWN
GE	YELLOW
GN	GREEN
GR	GRAY
OR	ORANGE
RS	PINK
RT	RED
SW	BLACK
VI	VIOLET
WS	WHITE



INJECTION ELECTRONICS (DME 1.3)

735i, 735iL

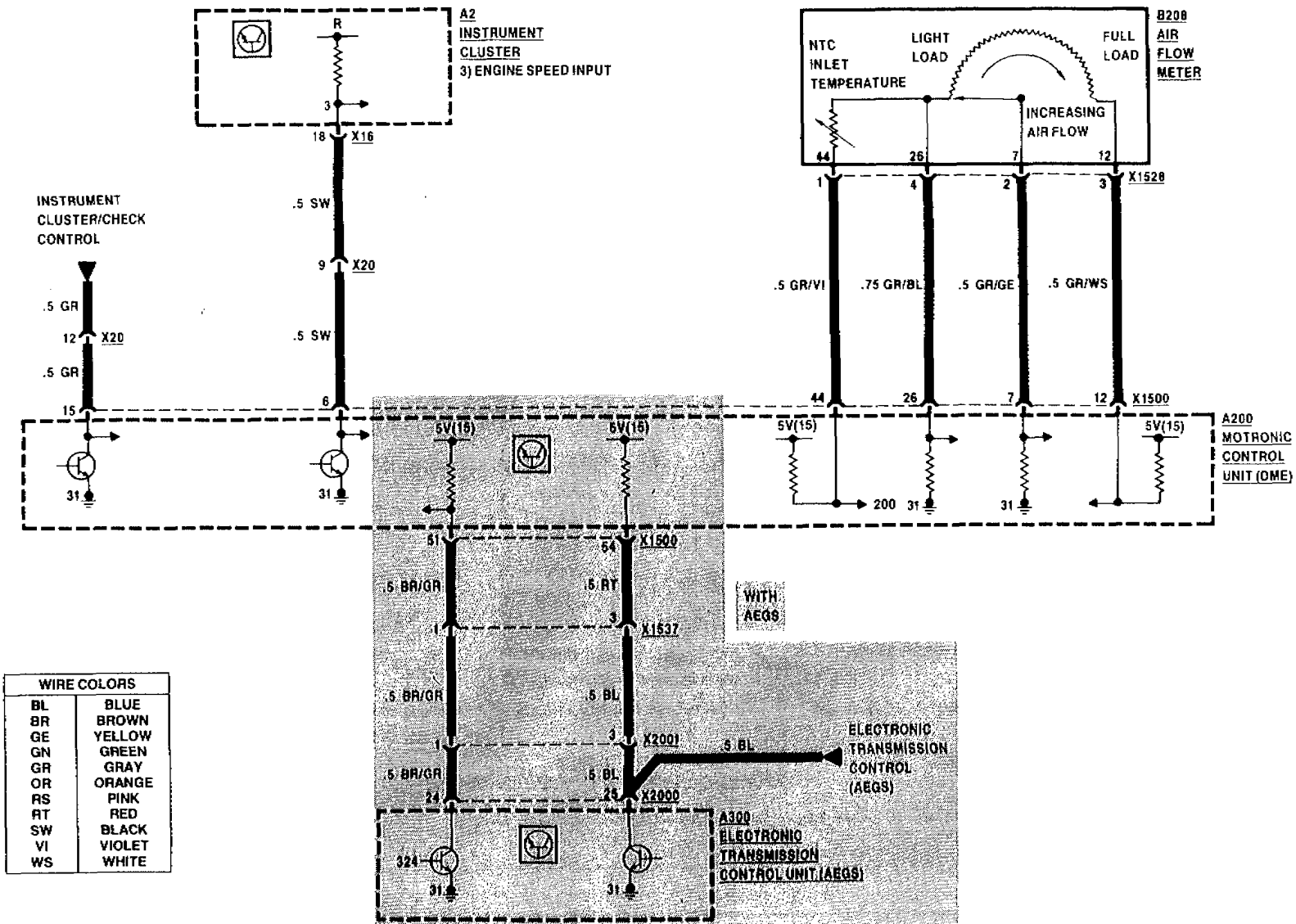



INJECTION ELECTRONICS (DME/EML 1.2)

POWER DISTRIBUTION

750iL

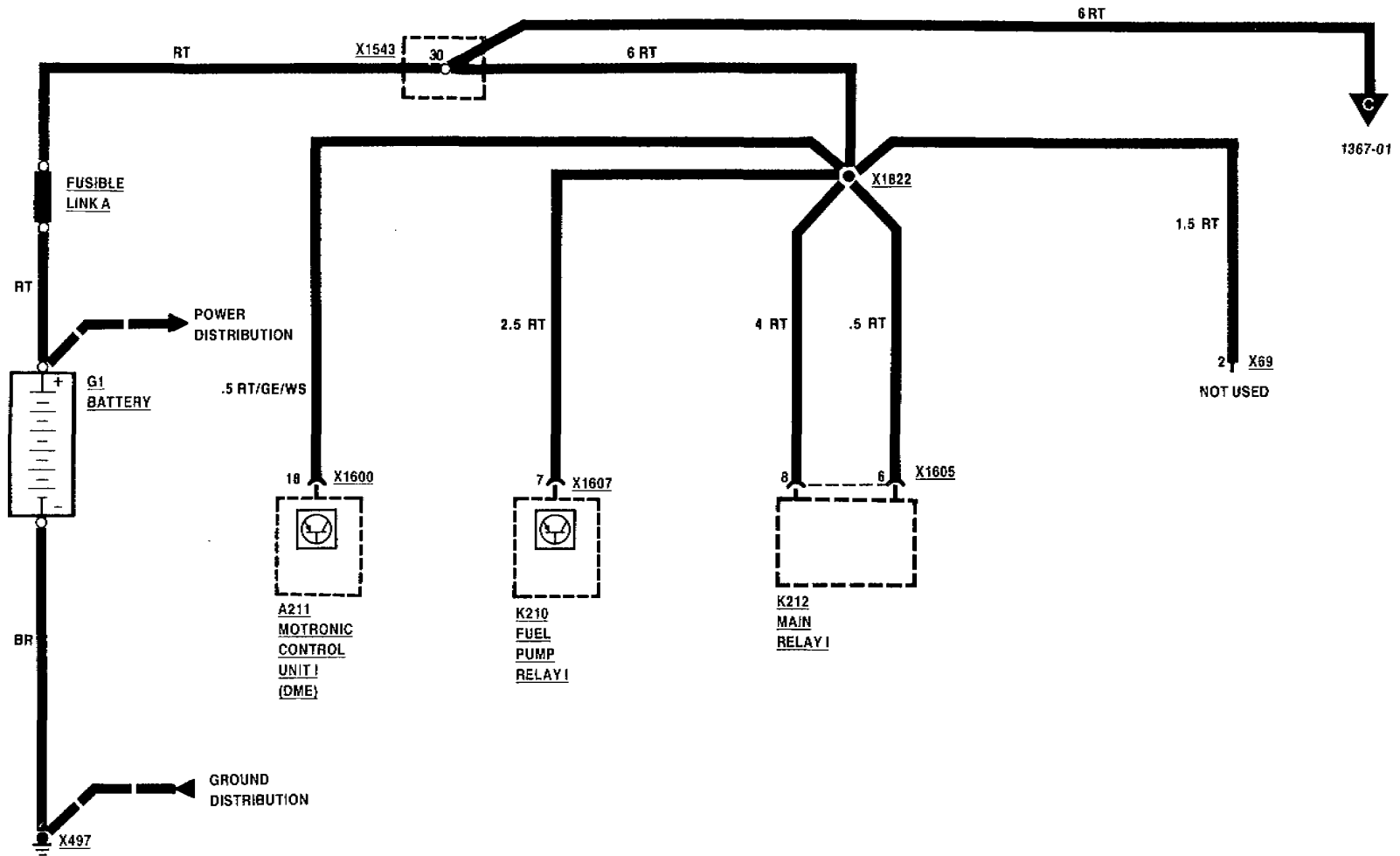

09/88

1367-00

1989



INJECTION ELECTRONICS (DME/EML 1.2) POWER DISTRIBUTION

750iL

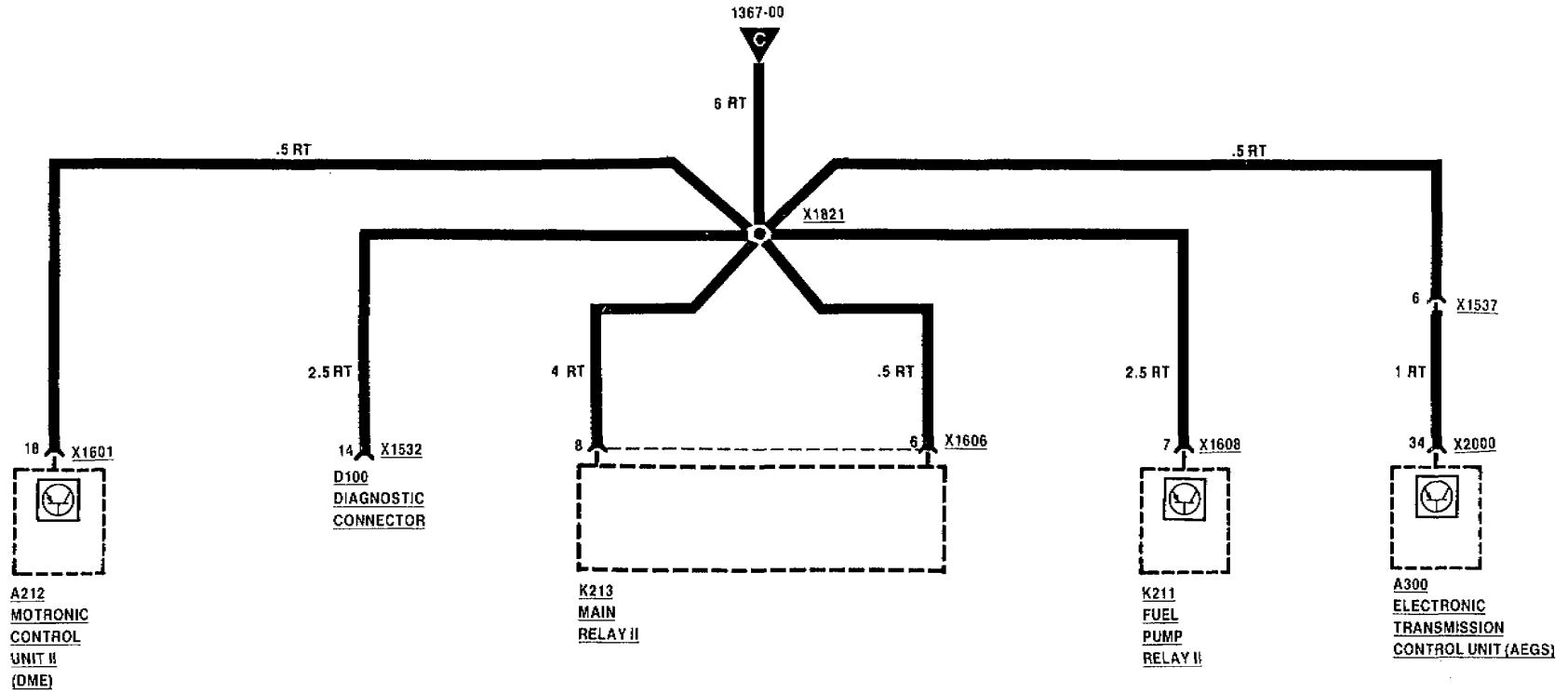



INJECTION ELECTRONICS (DME/EML 1 2) MOTRONIC CONTROL UNIT I

750iL

09/88

1367-02

1989

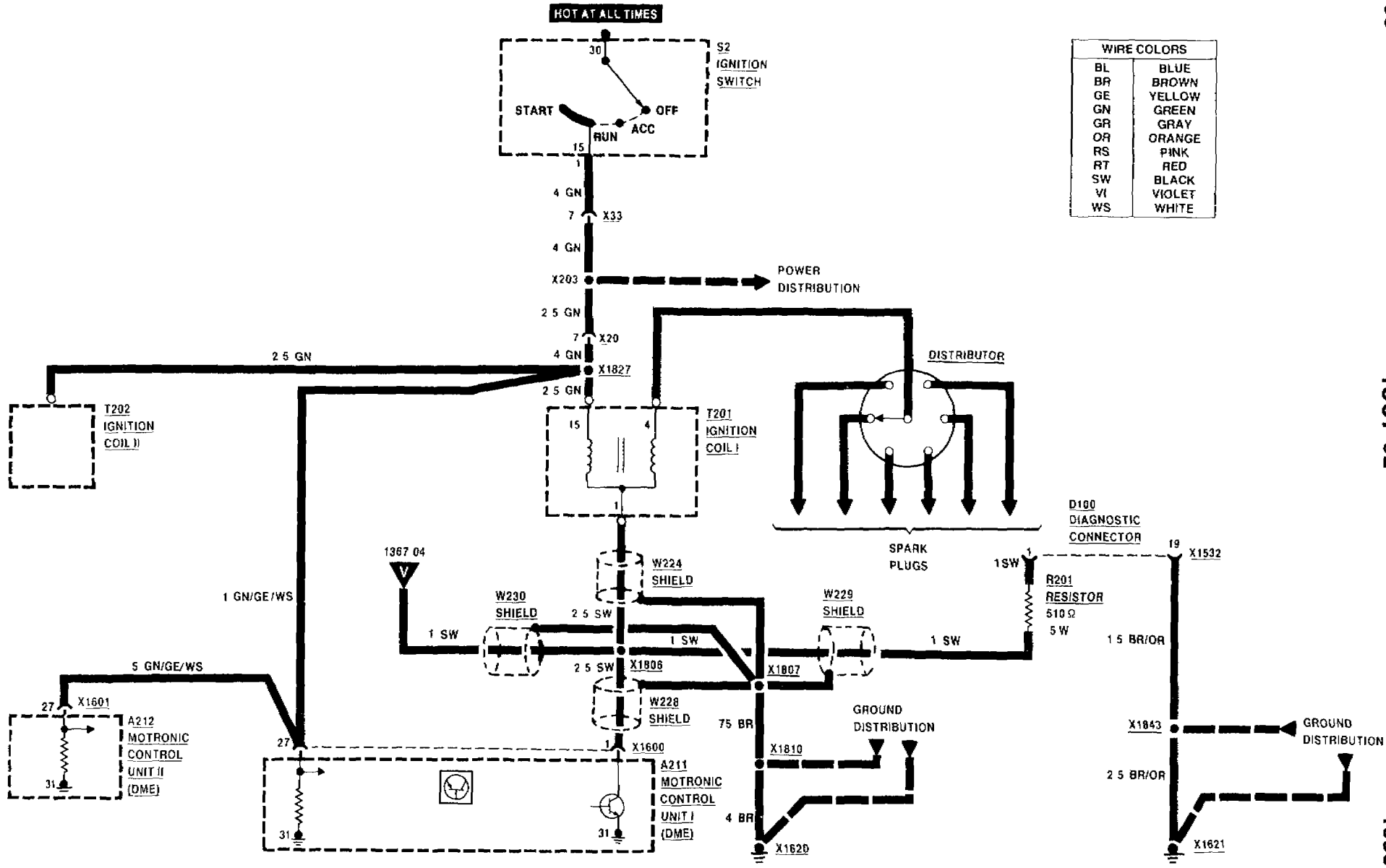

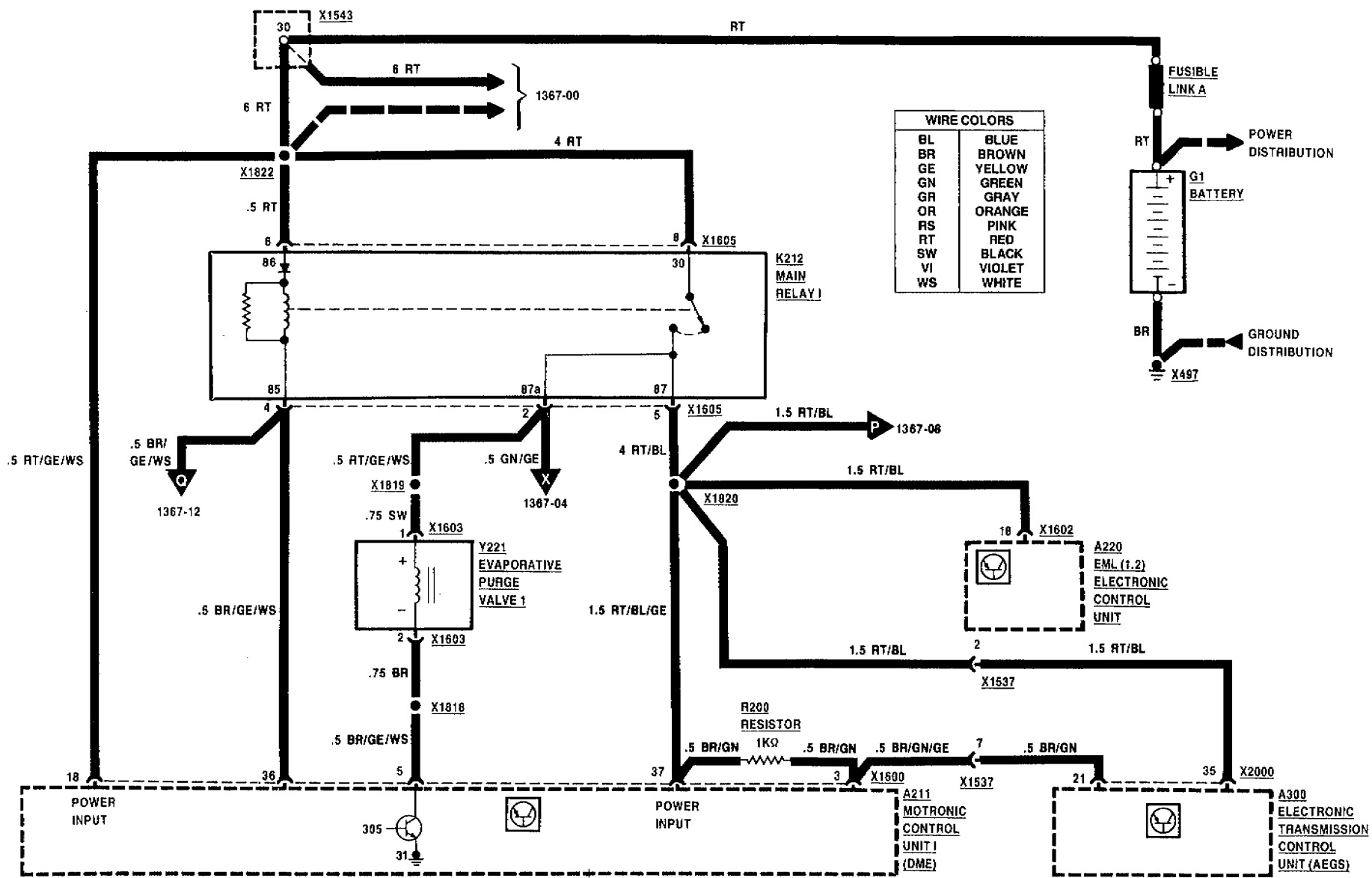



INJECTION ELECTRONICS (DME/EML 1.2)

MOTRONIC CONTROL UNIT I

750iL

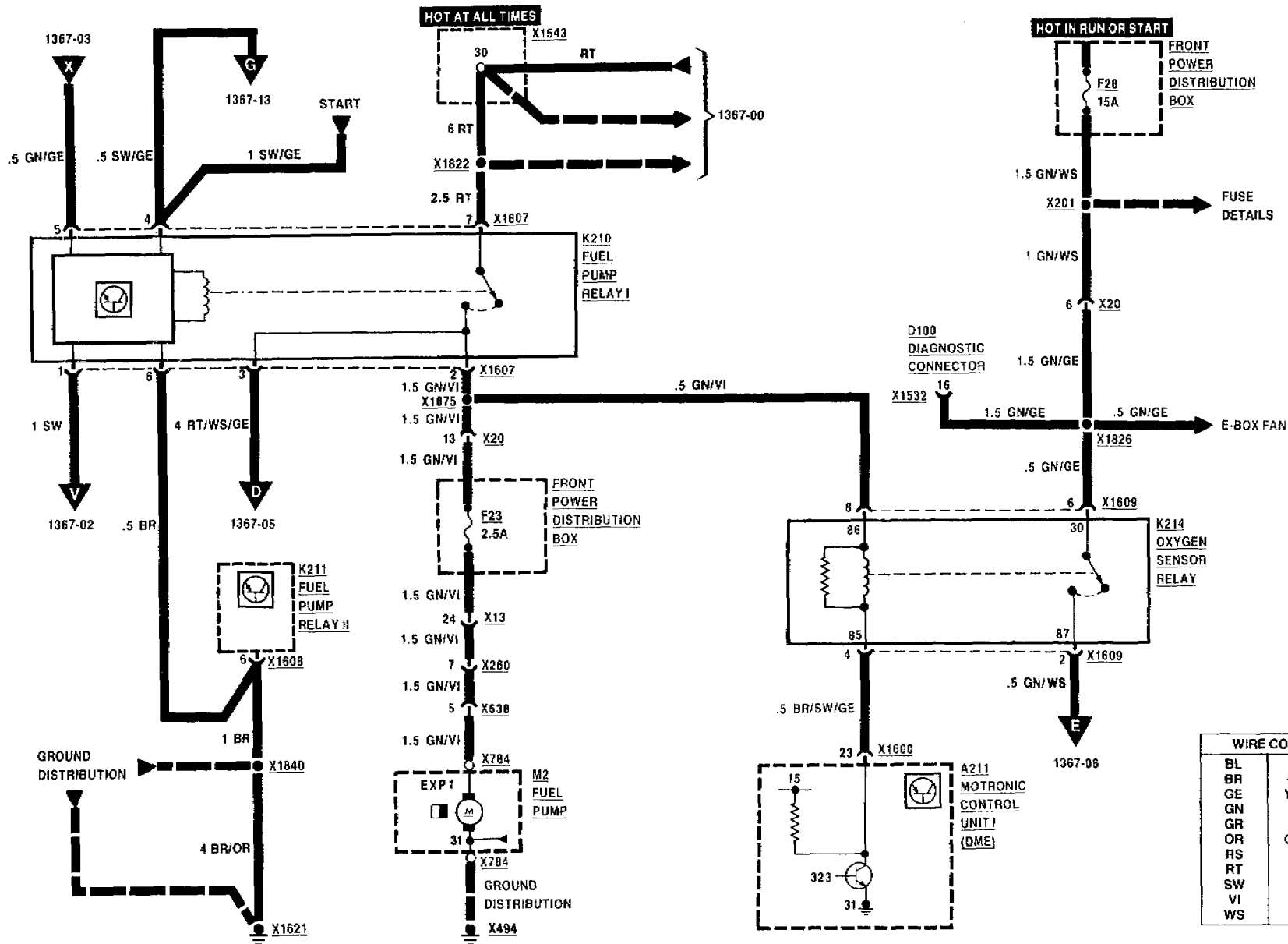



INJECTION ELECTRONICS (DME/EML 1.2) MOTRONIC CONTROL UNIT I

750iL

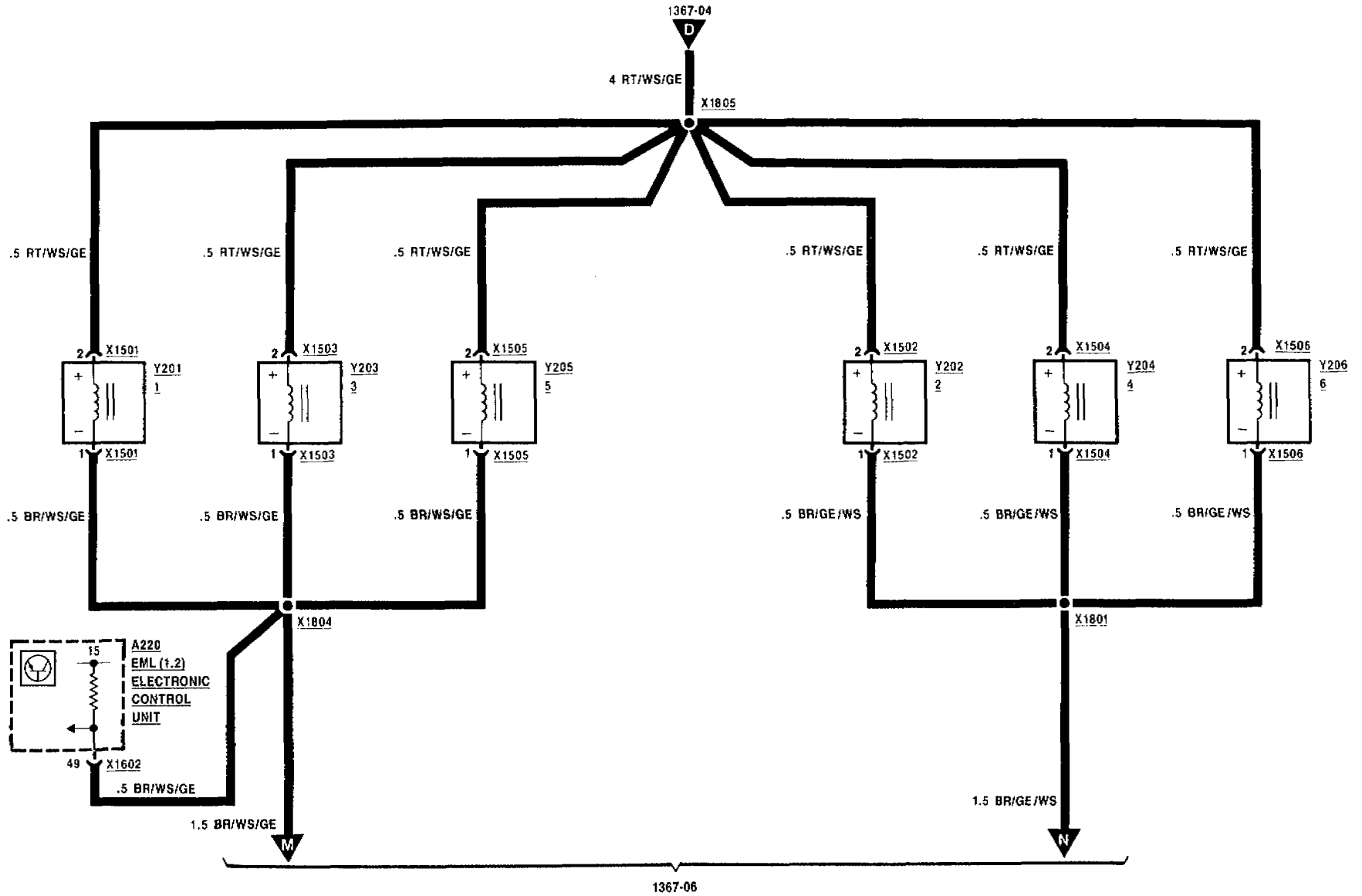

09/88

1367-05

1989



INJECTION ELECTRONICS (DME/EML 1.2)

MOTRONIC CONTROL UNIT I

750iL

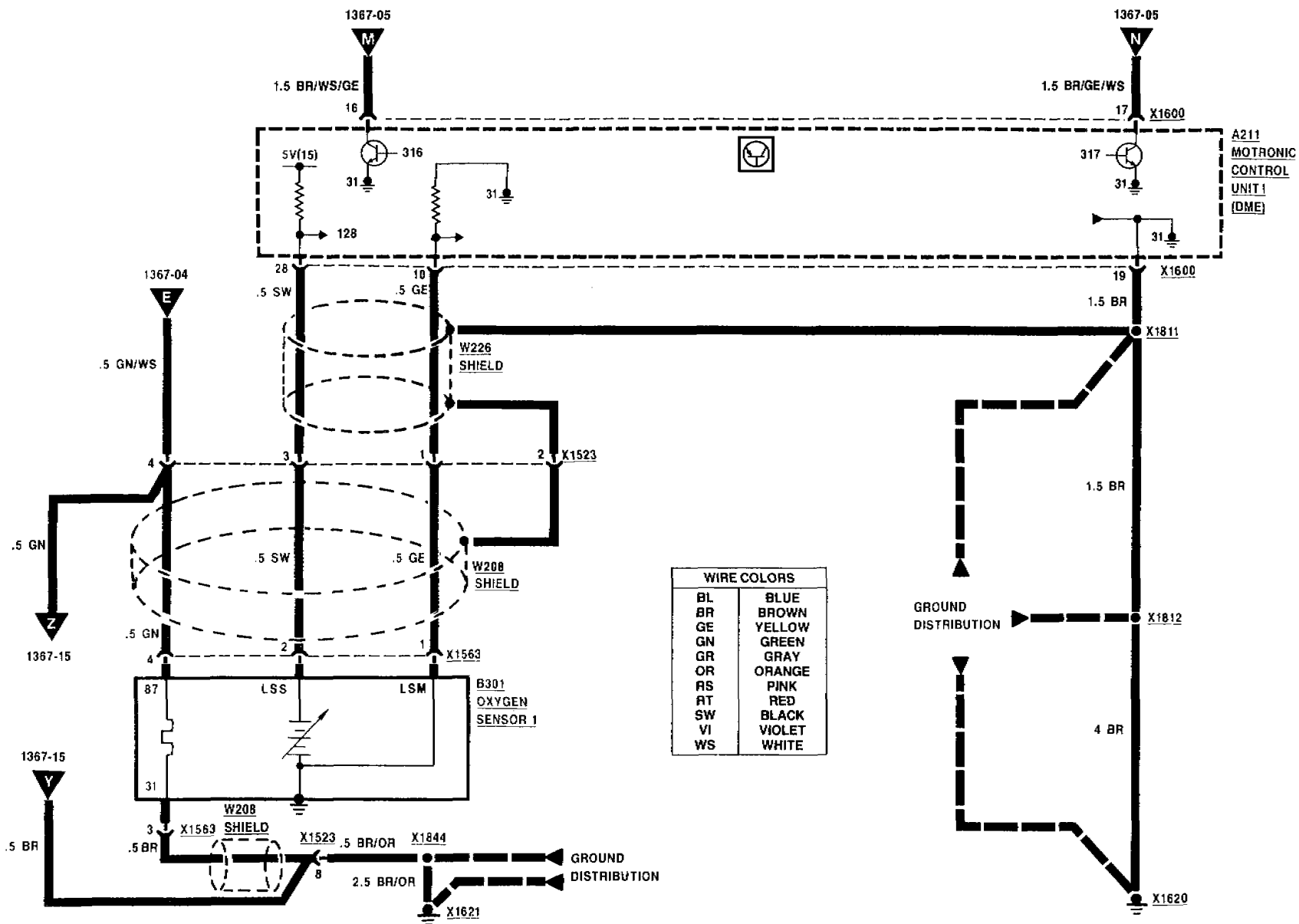



INJECTION ELECTRONICS (DME/EML 1.2)

750iL

MOTRONIC CONTROL UNIT I

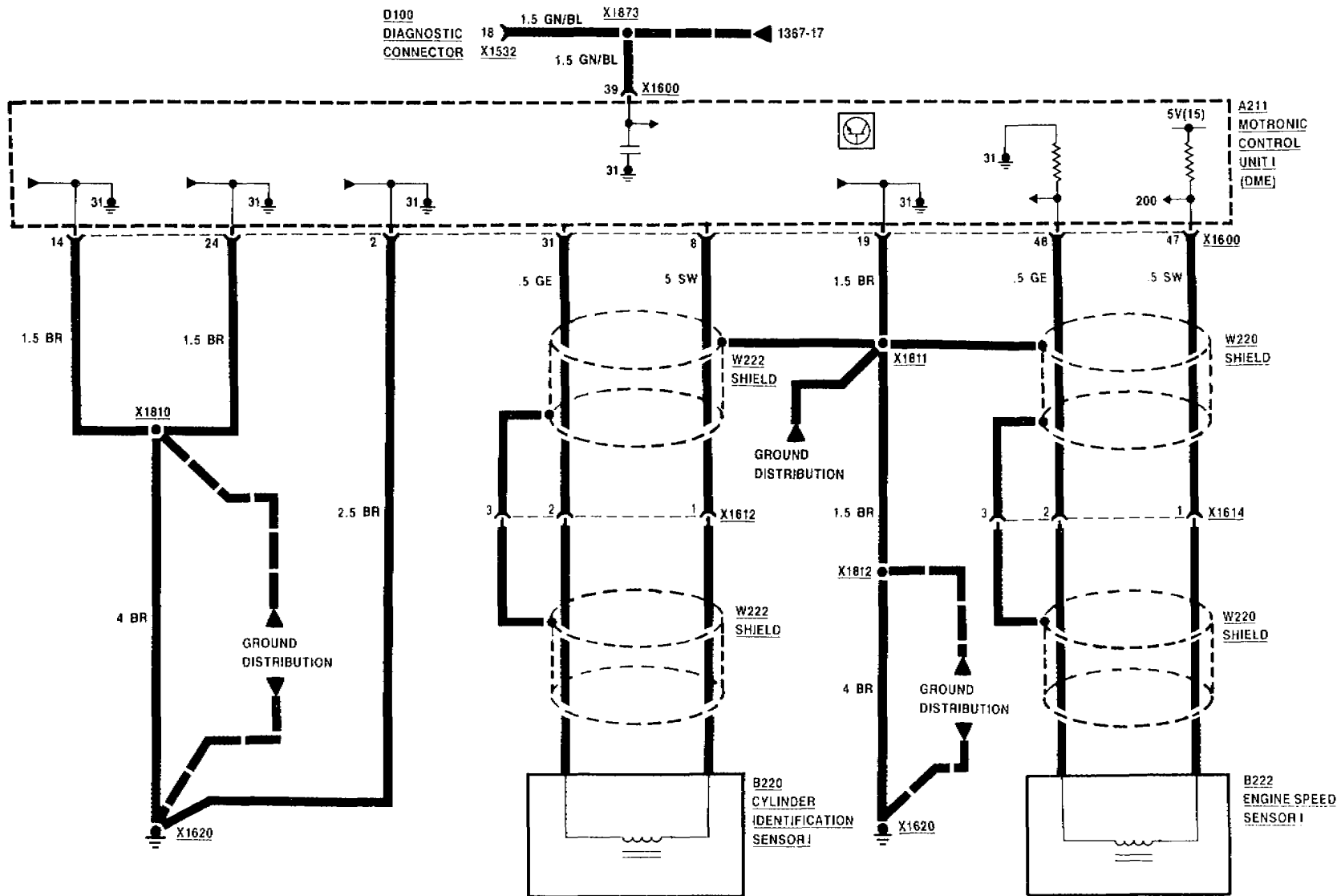

09/88

1367-07

1989



INJECTION ELECTRONICS (DME/EML 1.2)

MOTRONIC CONTROL UNIT I

750iL

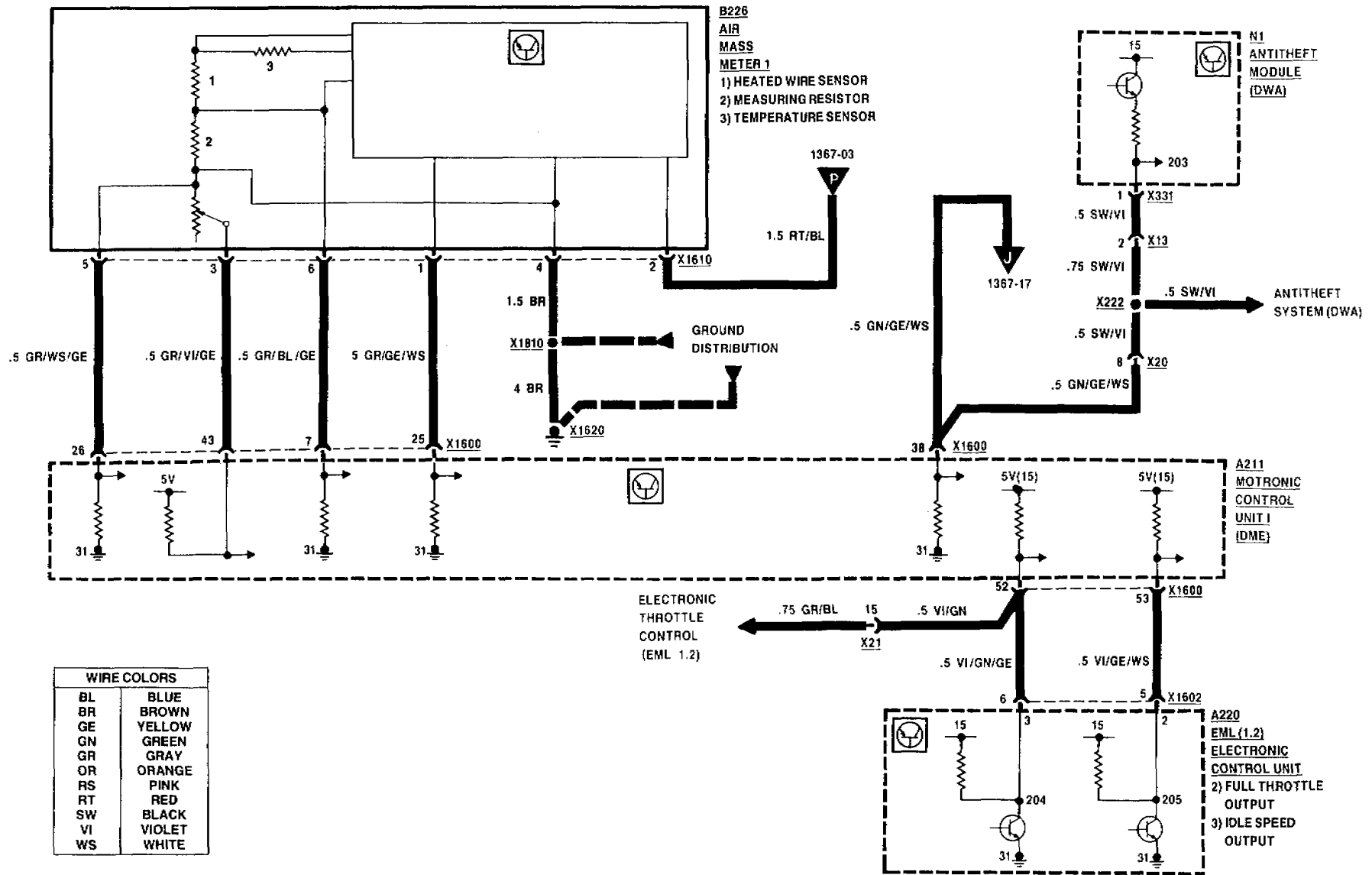



INJECTION ELECTRONICS (DME/EML 1.2)

750iL

MOTRONIC CONTROL UNIT I

WIRE COLORS	
BL	BLUE
BR	BROWN
GE	YELLOW
GN	GREEN
GR	GRAY
OR	ORANGE
RS	PINK
RT	RED
SW	BLACK
VI	VIOLET
WS	WHITE

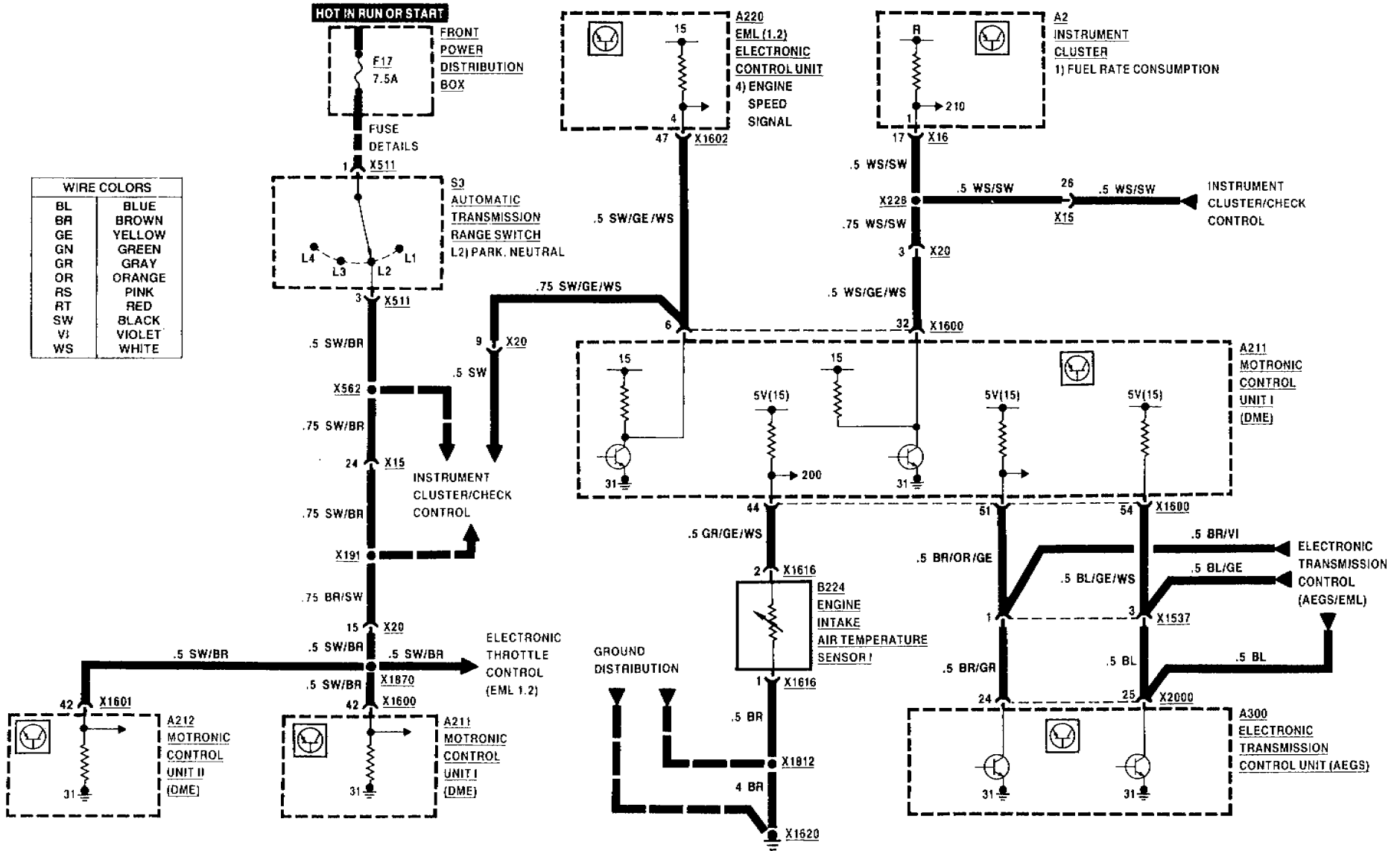



INJECTION ELECTRONICS (DME/EML 1.2) MOTRONIC CONTROL UNIT I

750iL

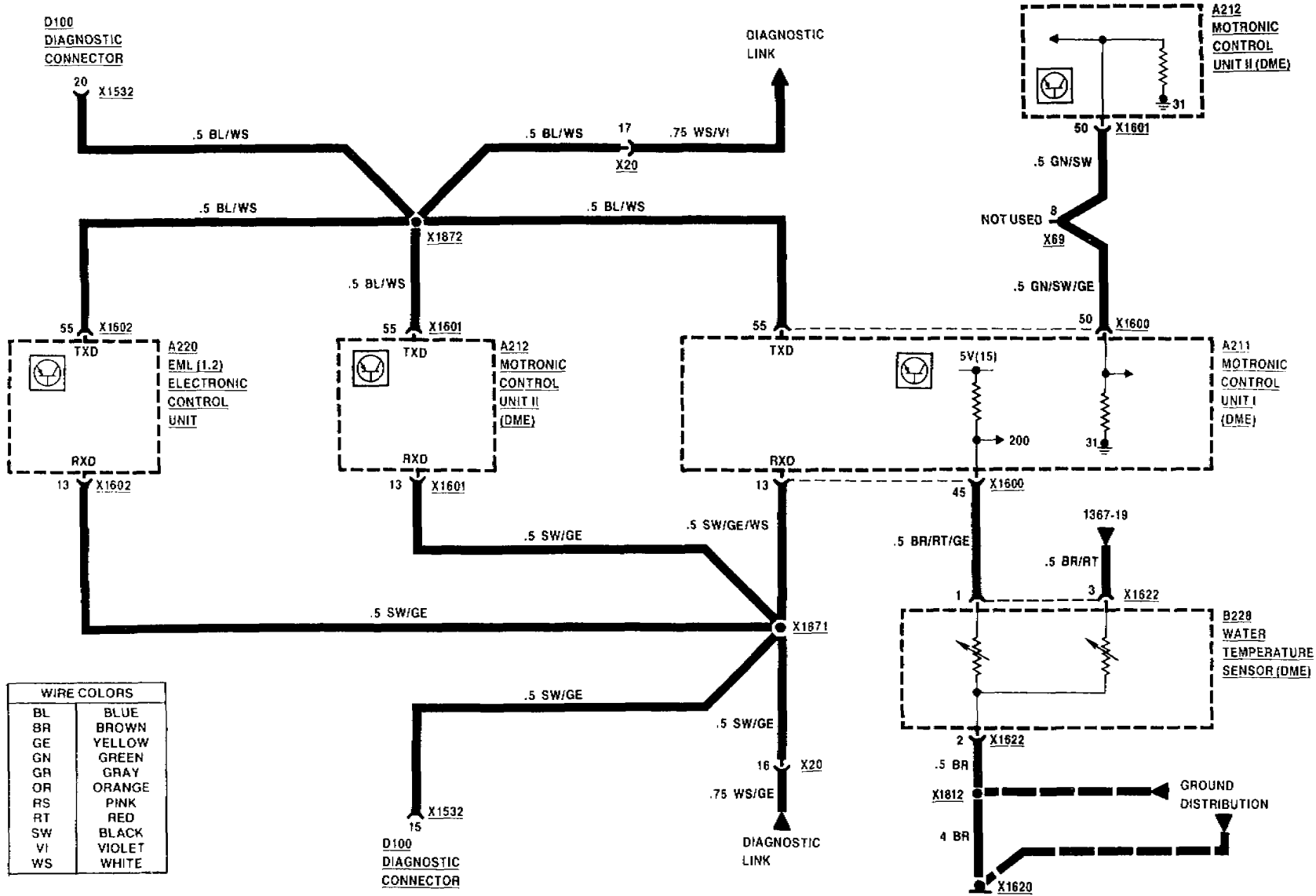

WIRE COLORS	
BL	BLUE
BR	BROWN
GE	YELLOW
GN	GREEN
GR	GRAY
OR	ORANGE
RS	PINK
RT	RED
SW	BLACK
VI	VIOLET
WS	WHITE



INJECTION ELECTRONICS (DME/EML 1.2)

MOTRONIC CONTROL UNIT II

750iL

09/88

1367-11

1989

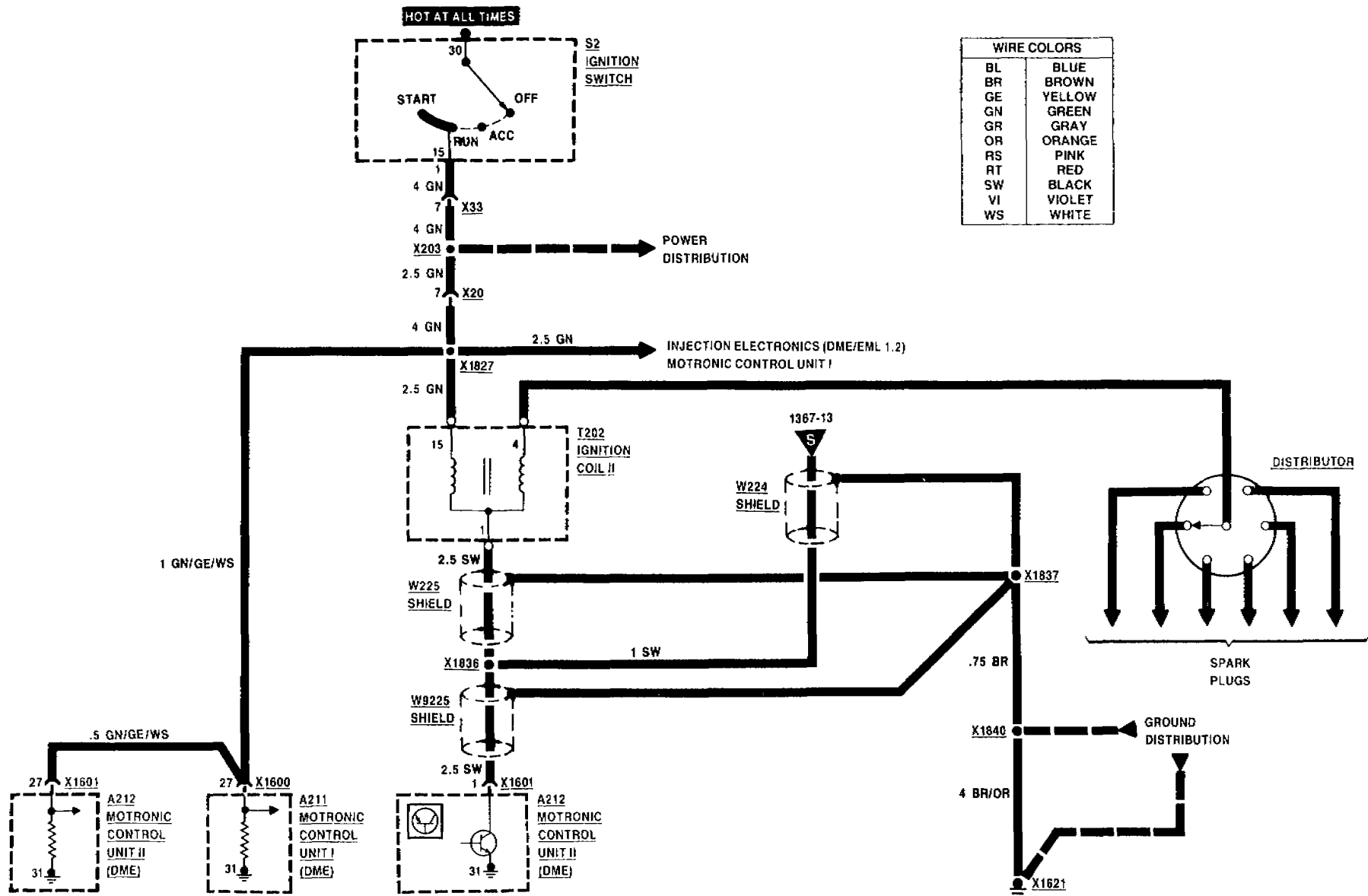



INJECTION ELECTRONICS (DME/EML 1.2)

750iL

MOTRONIC CONTROL UNIT II

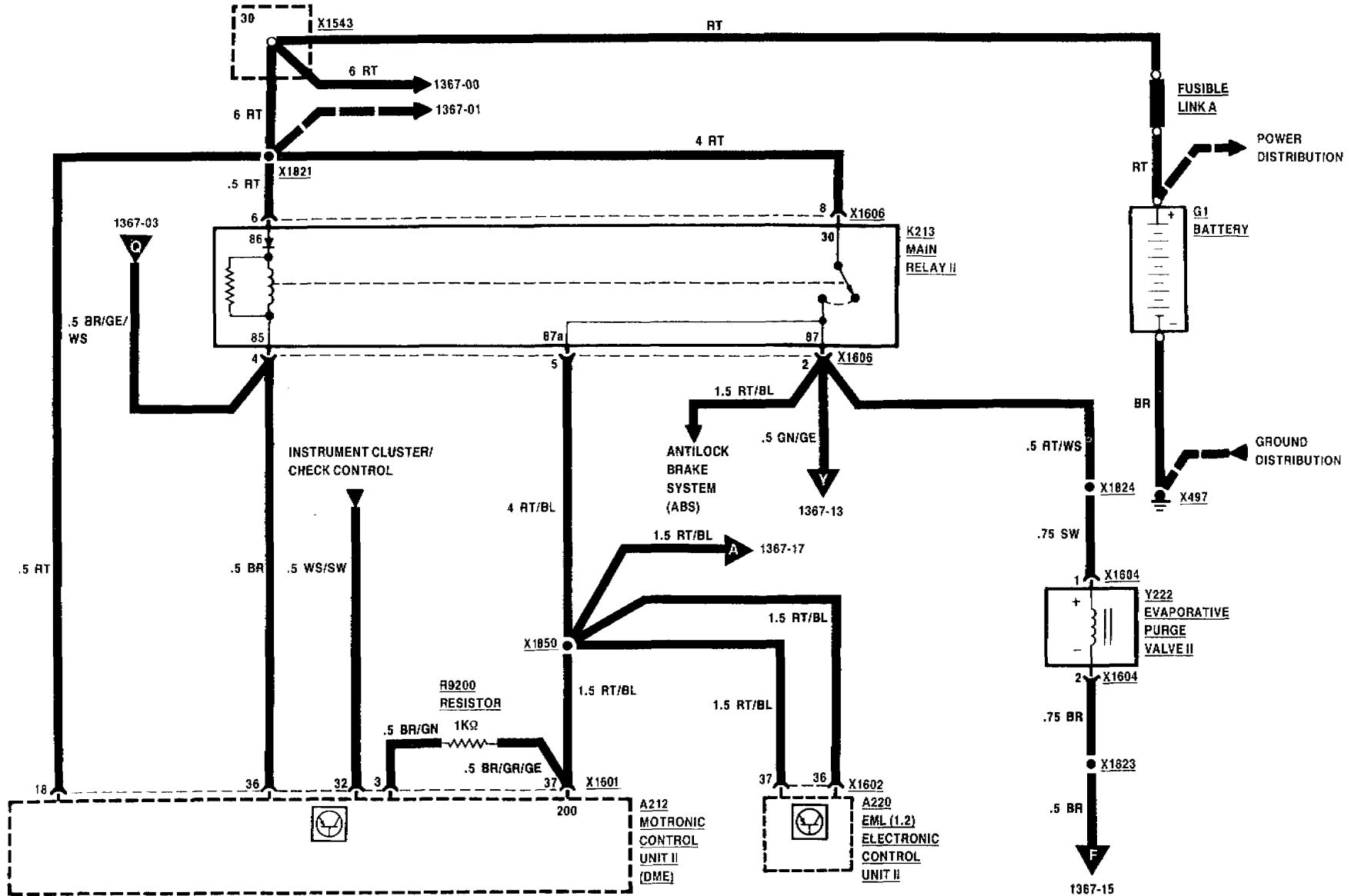



INJECTION ELECTRONICS (DME/EML 1.2)

MOTRONIC CONTROL UNIT II

750iL

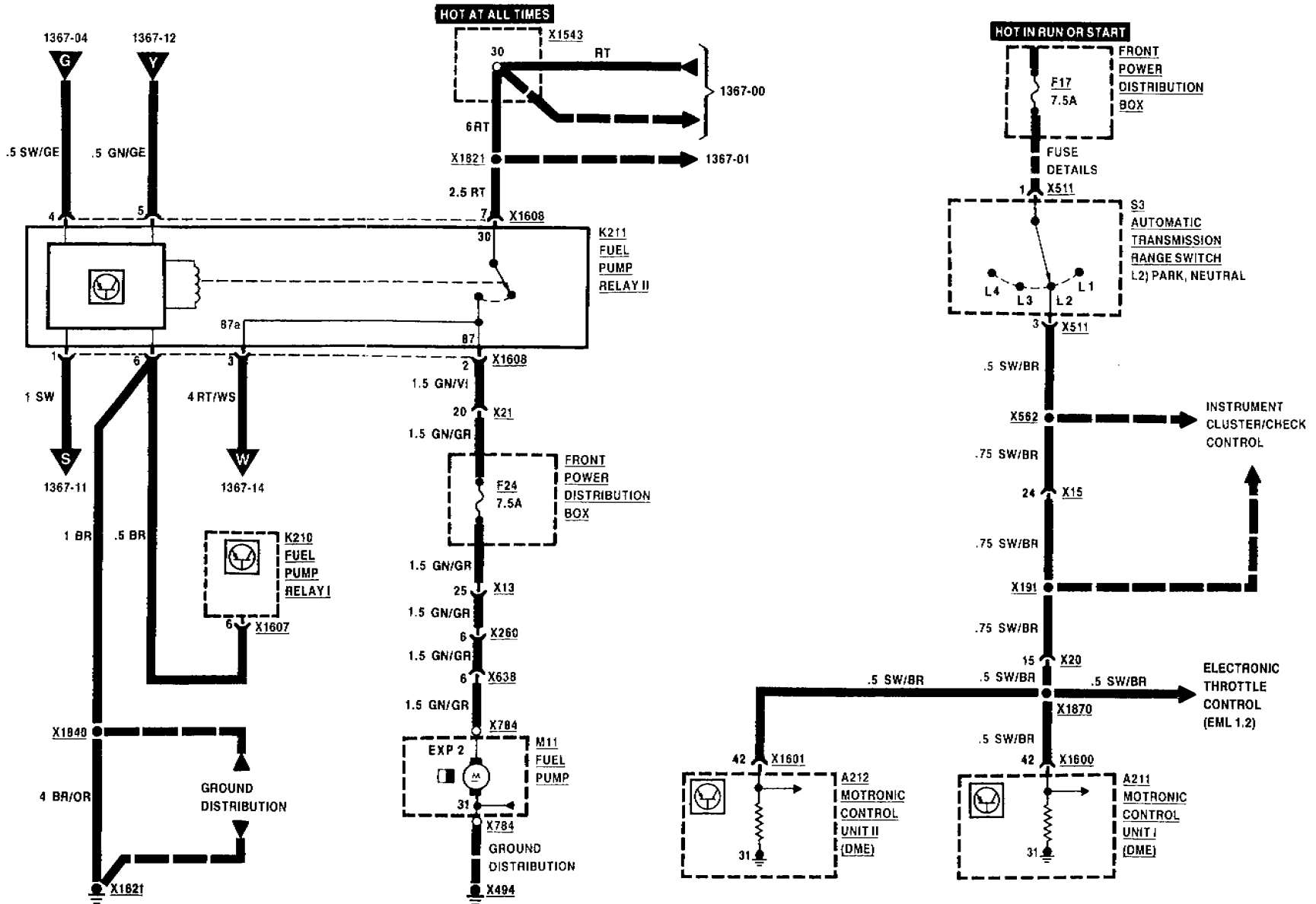



INJECTION ELECTRONICS (DME/EML 1.2) MOTRONIC CONTROL UNIT II

750iL

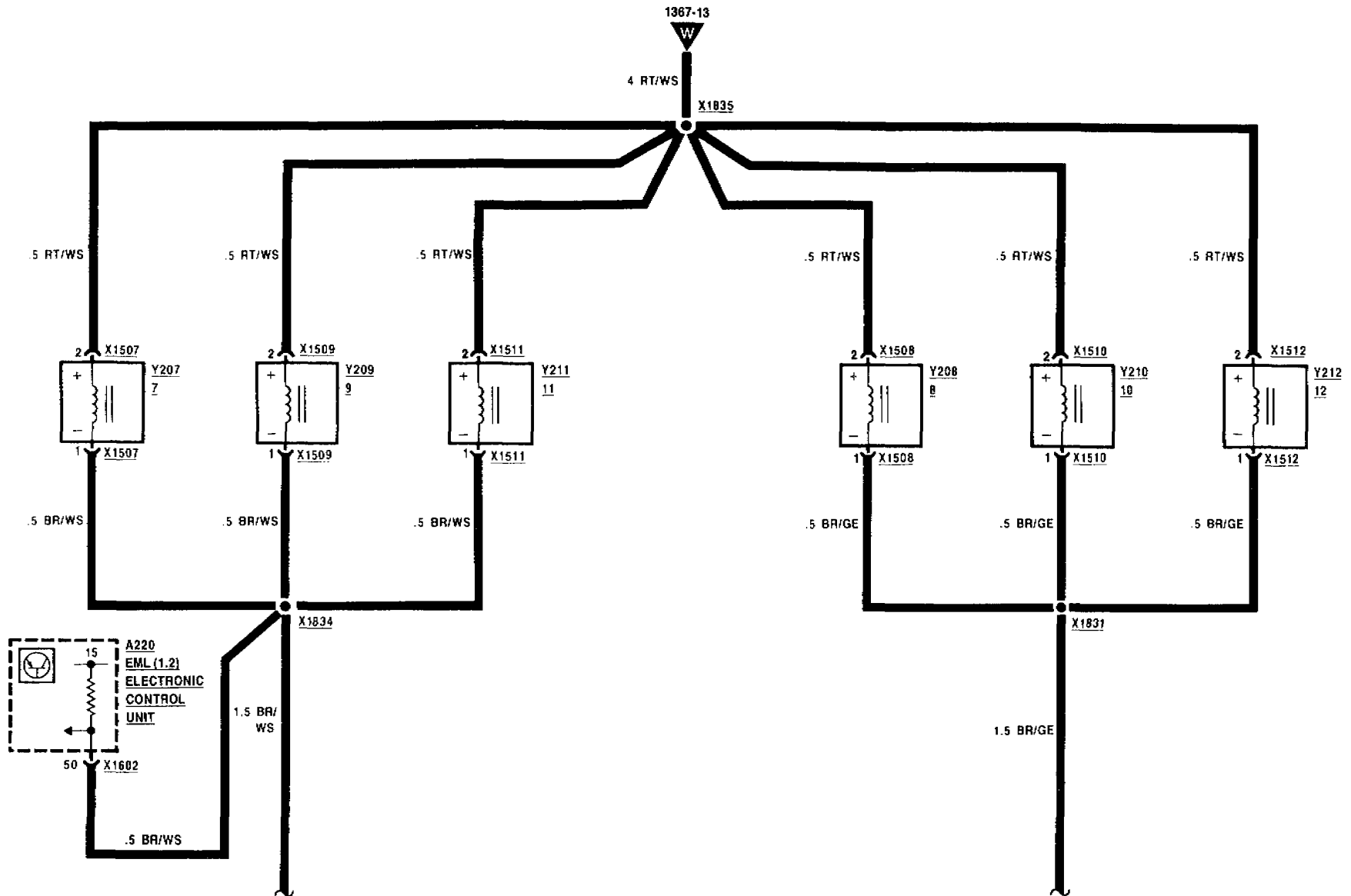

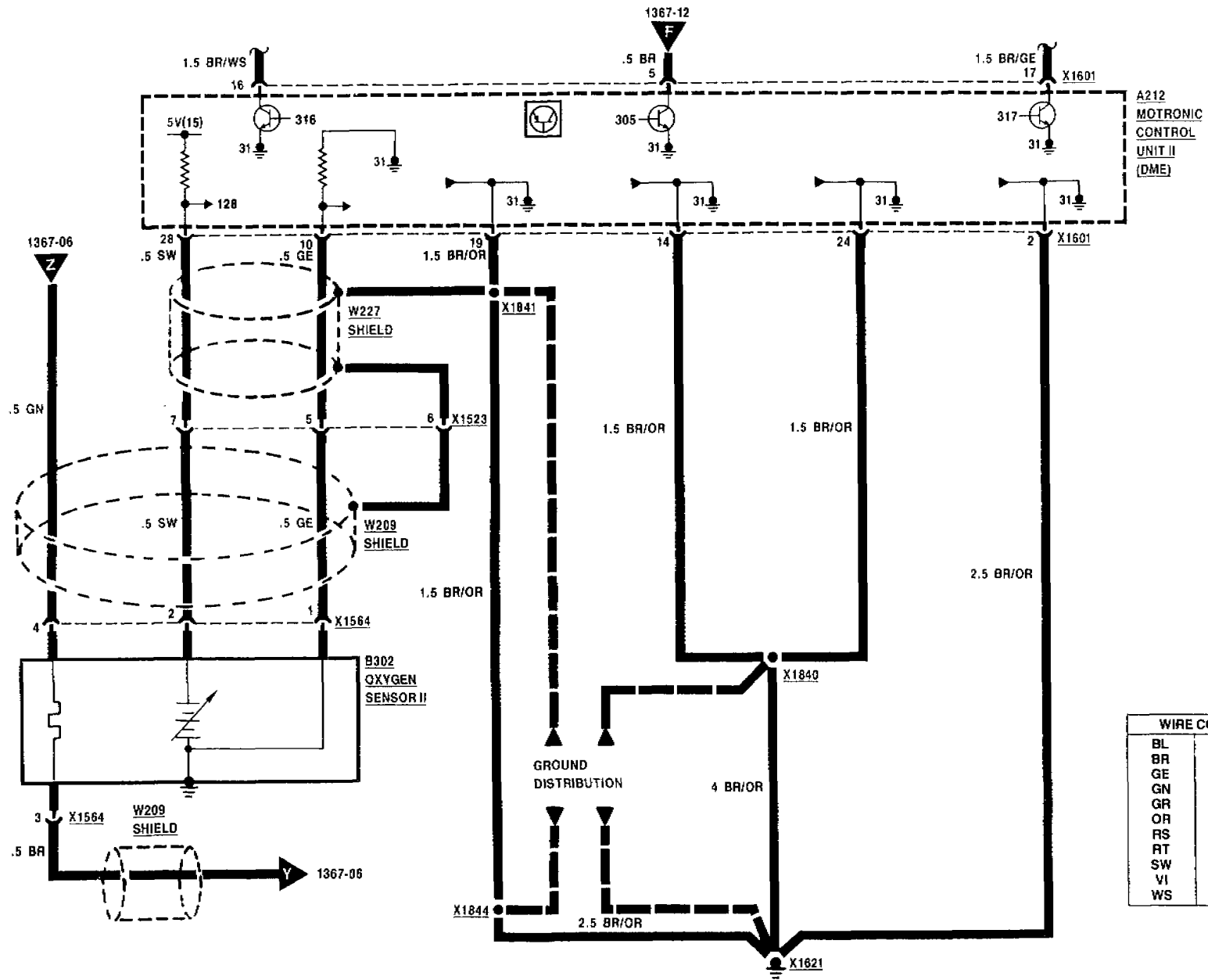

WIRE COLORS	
BL	BLUE
BR	BROWN
GE	YELLOW
GN	GREEN
GR	GRAY
OR	ORANGE
RS	PINK
RT	RED
SW	BLACK
VI	VIOLET
WS	WHITE



INJECTION ELECTRONICS (DME/EML 1.2)

750iL

MOTRONIC CONTROL UNIT II

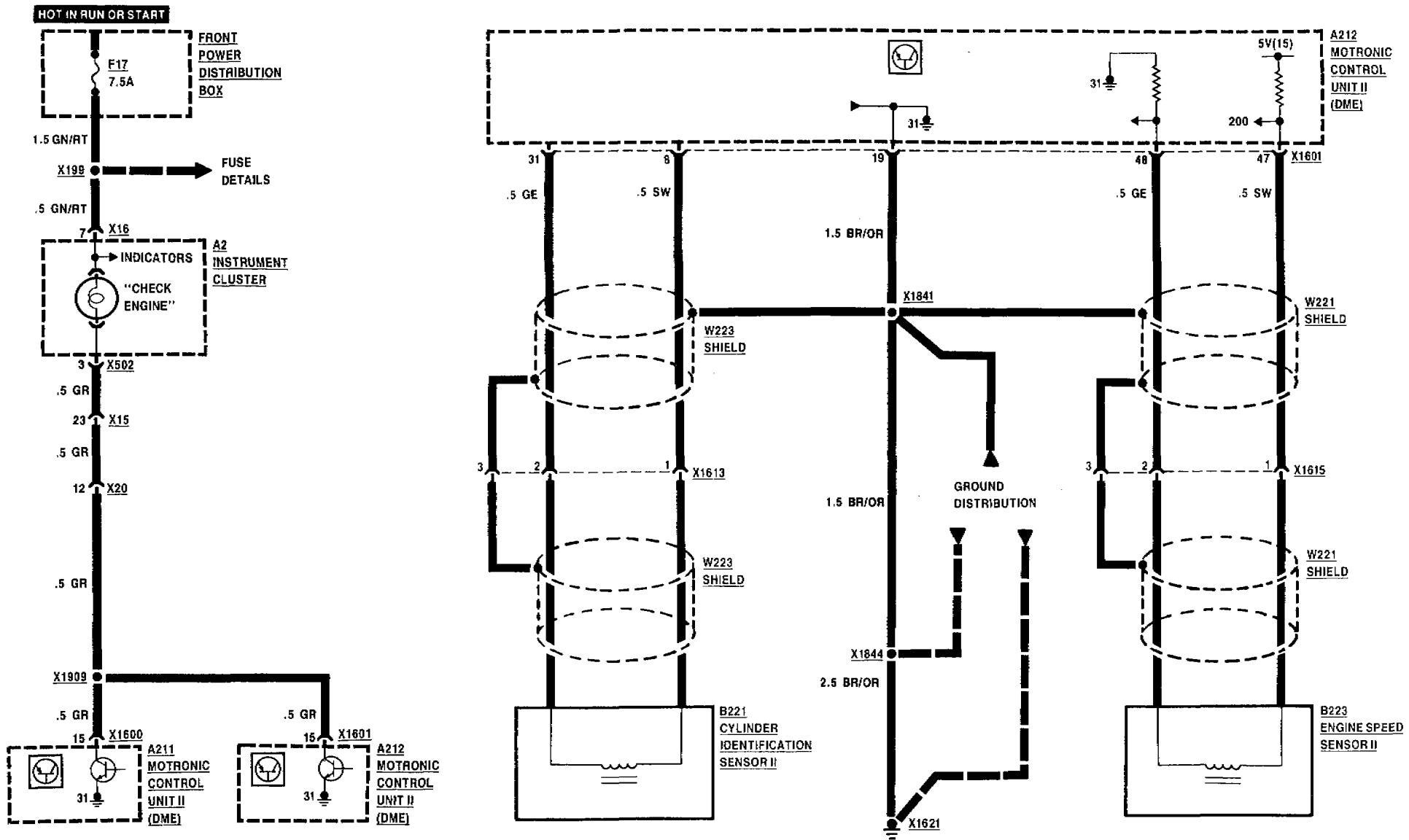

11/89

1367-16

1989



**INJECTION ELECTRONICS (DME/EML 1.2)
MOTRONIC CONTROL UNIT II**

750iL

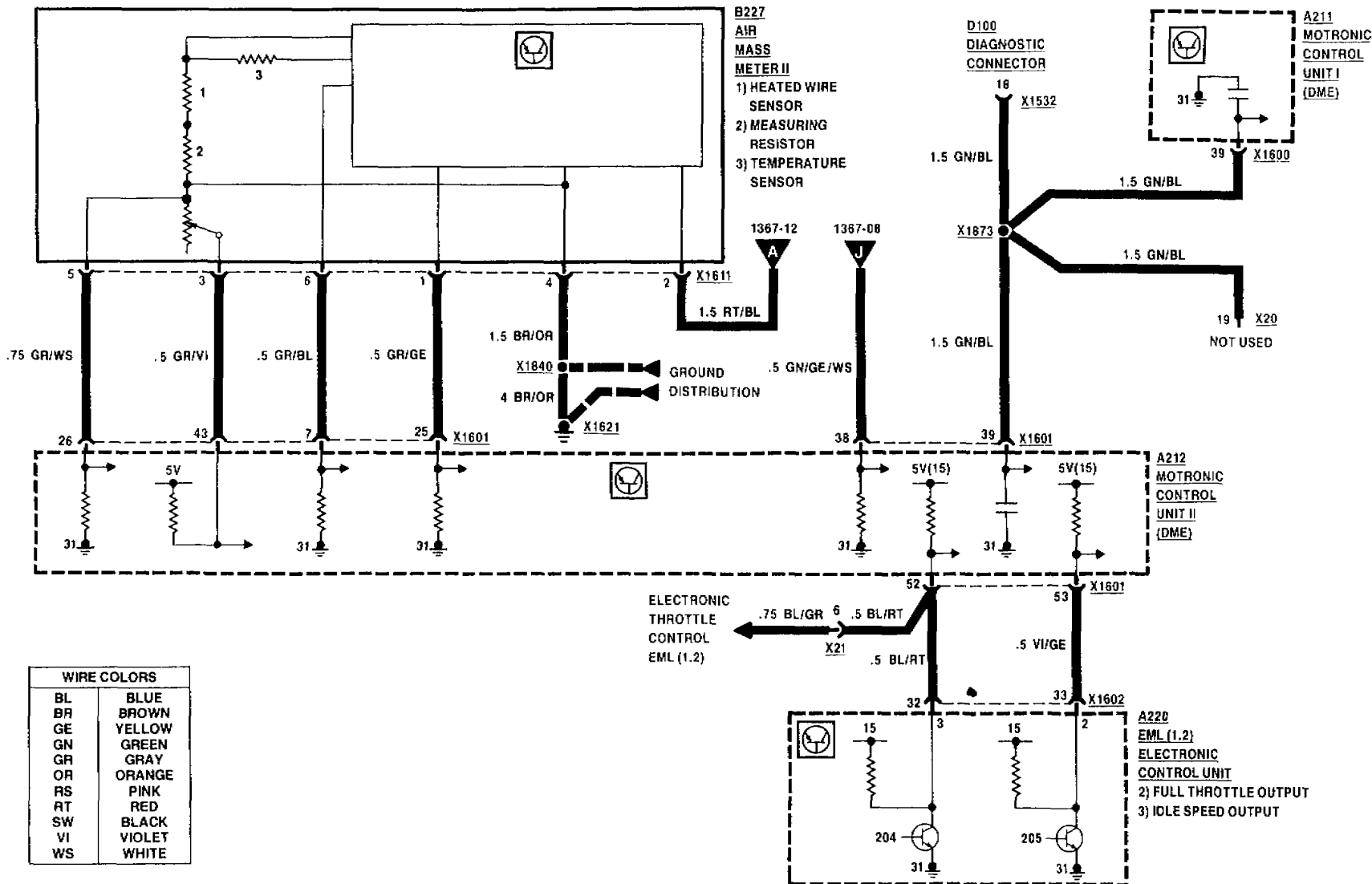

WIRE COLORS	
BL	BLUE
BR	BROWN
GE	YELLOW
GN	GREEN
GR	GRAY
OR	ORANGE
RS	PINK
RT	RED
SW	BLACK
VI	VIOLET
WS	WHITE



INJECTION ELECTRONICS (DME/EML 1.2)

MOTRONIC CONTROL UNIT II

750iL

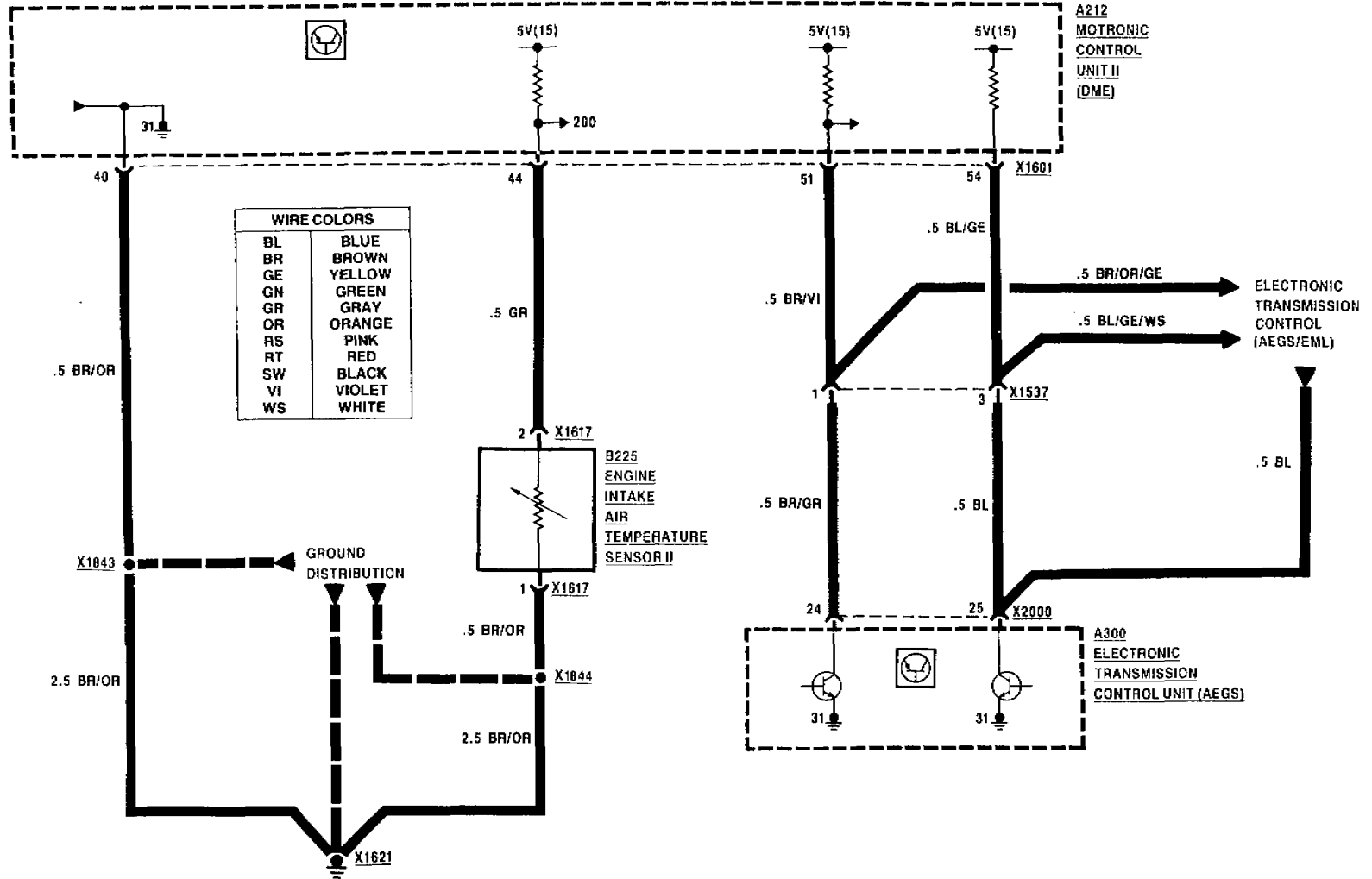



INJECTION ELECTRONICS (DME/EML 1.2)

MOTRONIC CONTROL UNIT II

750iL

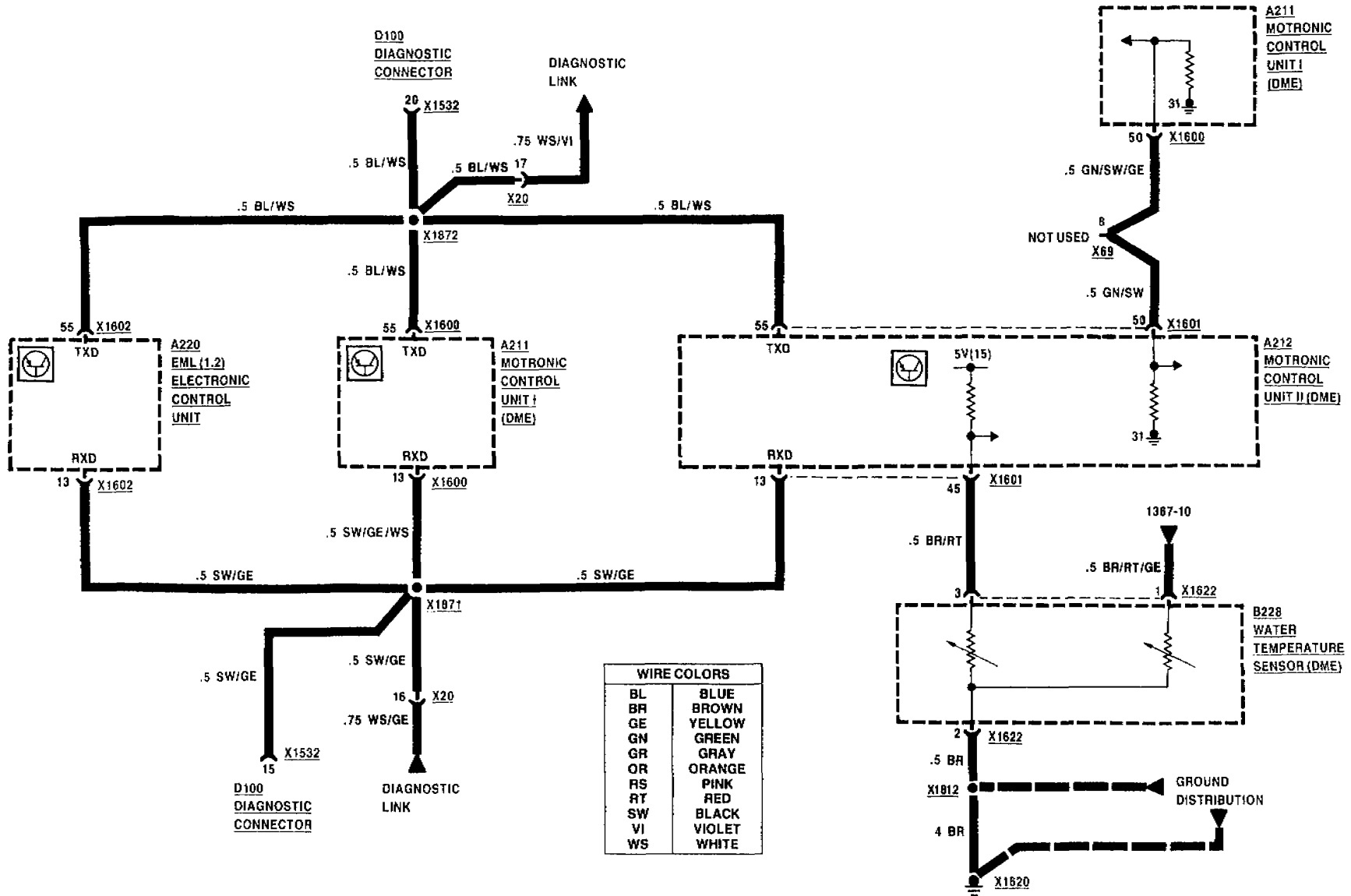

09/88

1367-19

1989



ELECTRONIC THROTTLE CONTROL (EML 1.2)

750iL

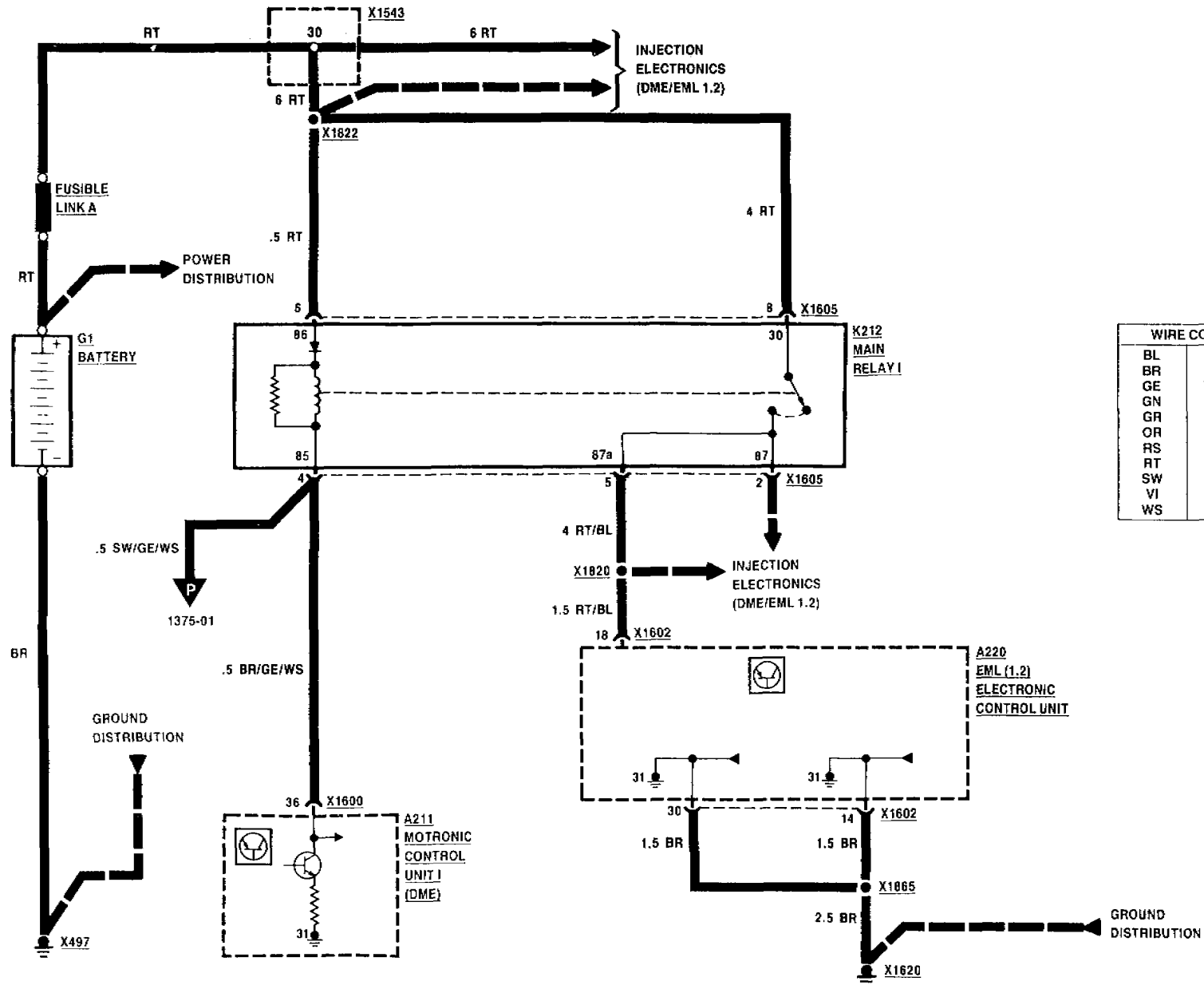



ELECTRONIC THROTTLE CONTROL (EML 1.2)

750iL

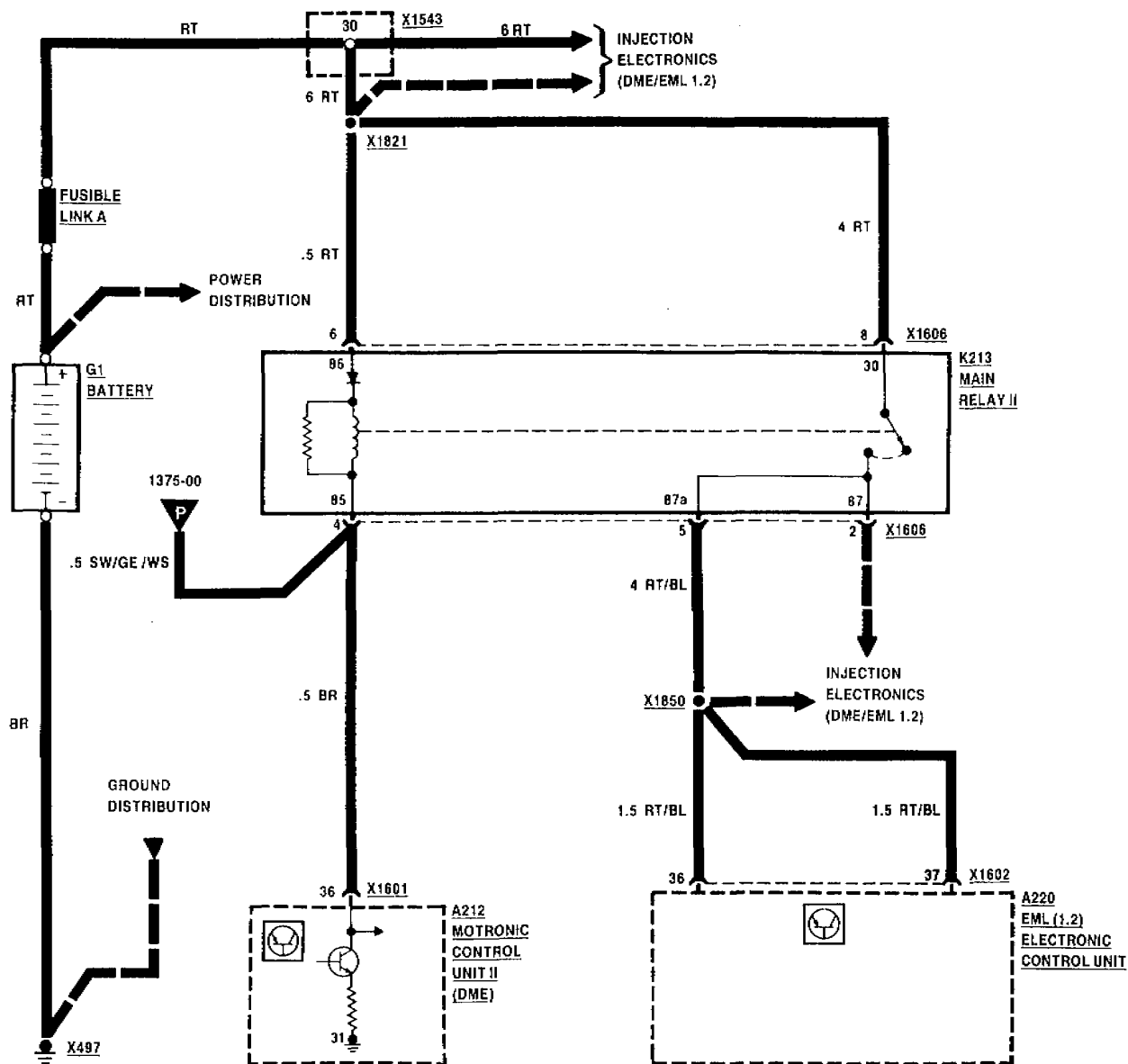

WIRE COLORS	
BL	BLUE
BR	BROWN
GE	YELLOW
GN	GREEN
GR	GRAY
OR	ORANGE
RS	PINK
RT	RED
SW	BLACK
VI	VIOLET
WS	WHITE



ELECTRONIC THROTTLE CONTROL (EML 1.2)

750iL

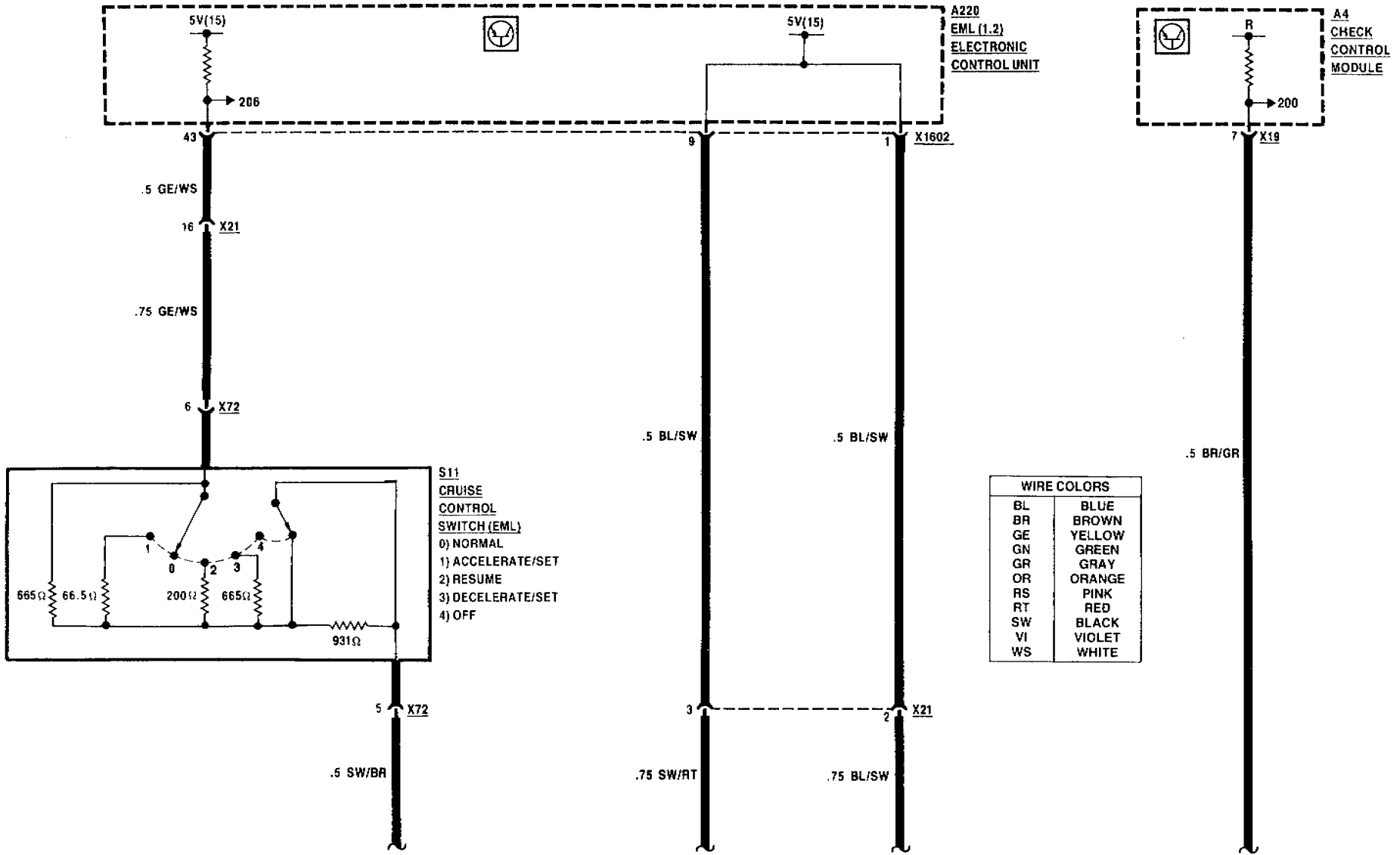

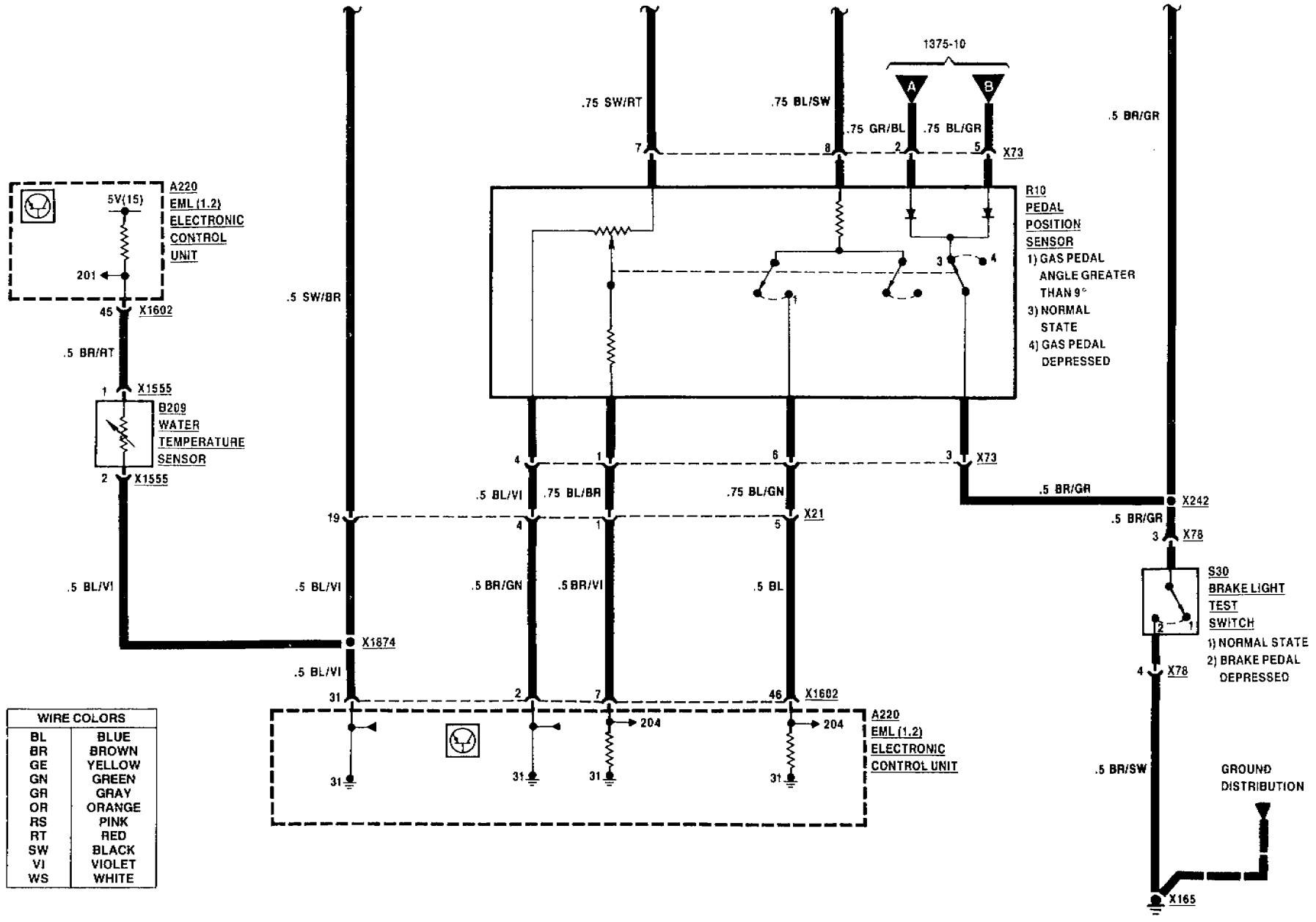



ELECTRONIC THROTTLE CONTROL (EML 1.2)

750iL

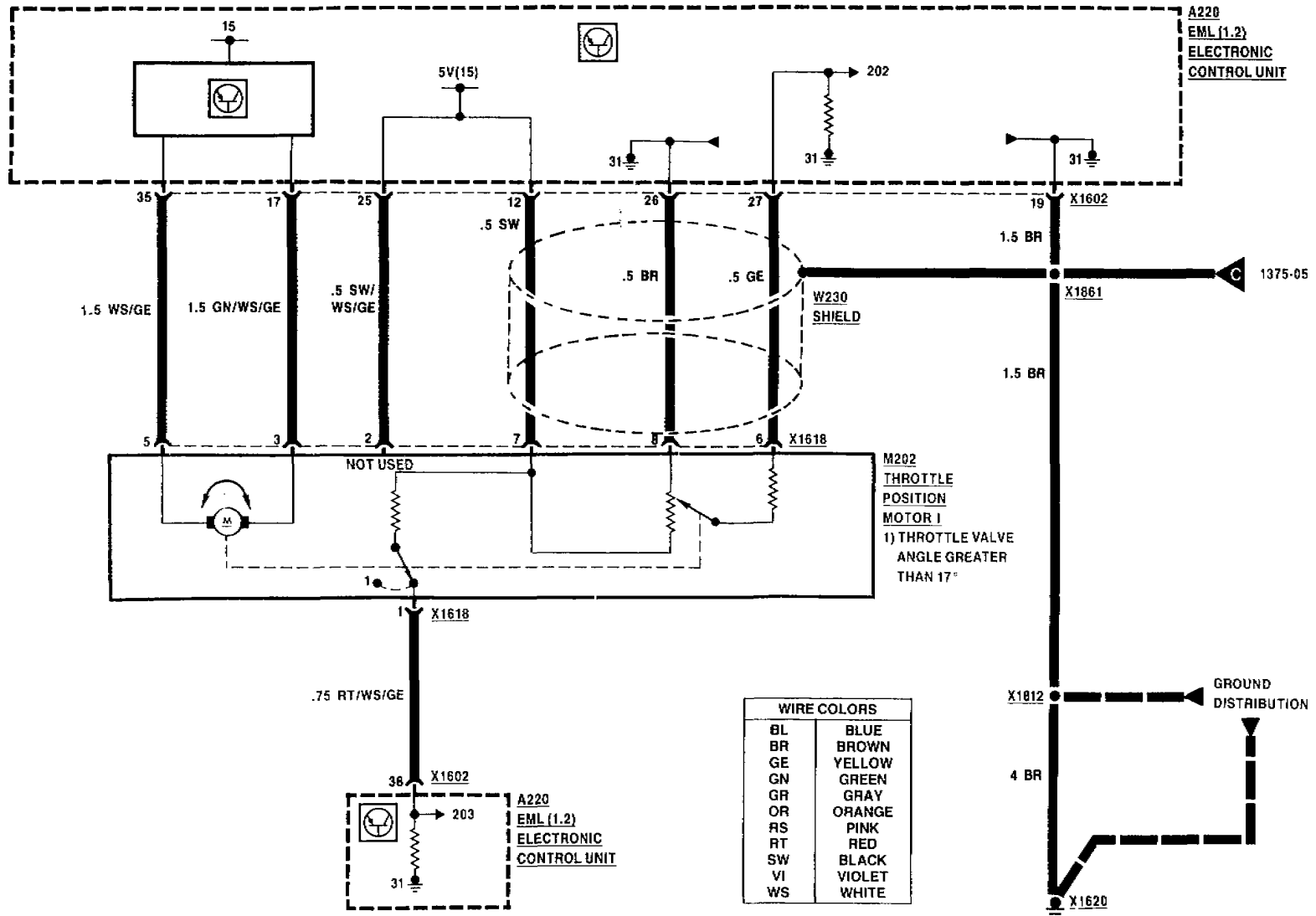

09/88 ————— 1375-04 ————— 1989



ELECTRONIC THROTTLE CONTROL (EML 1.2)

750iL

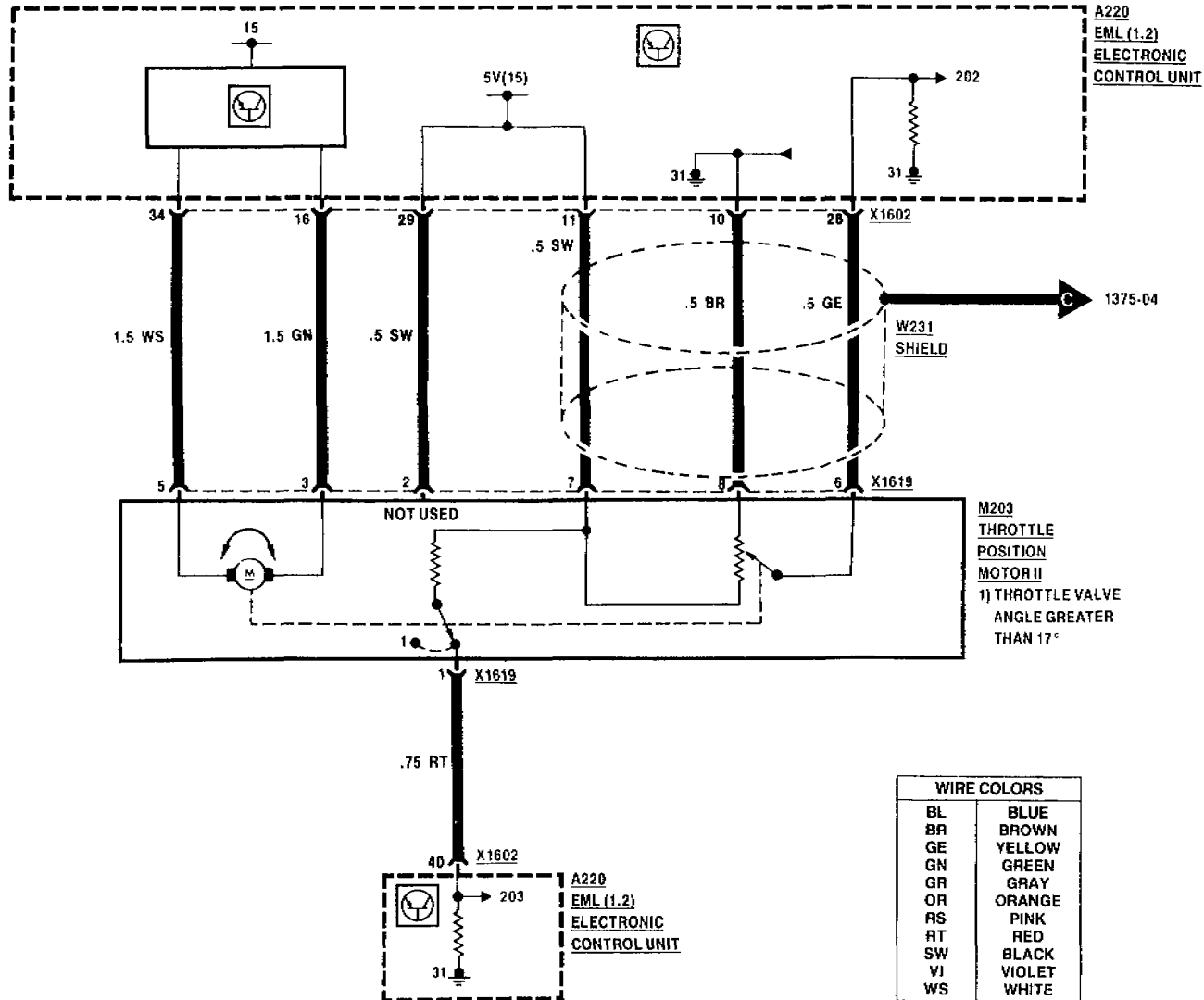



ELECTRONIC THROTTLE CONTROL (EML 1.2)

750iL

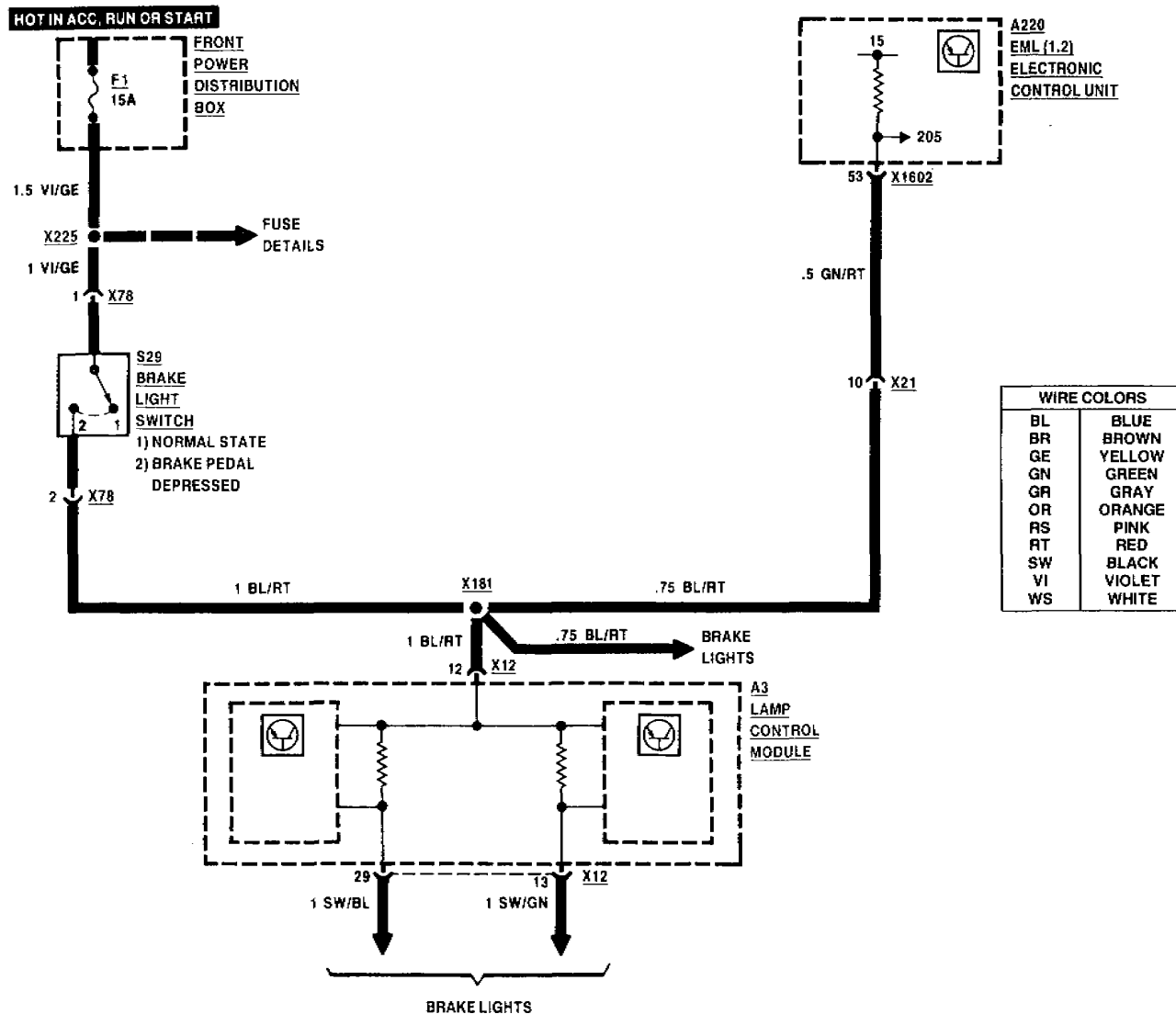



ELECTRONIC THROTTLE CONTROL (EML 1.2)

750iL

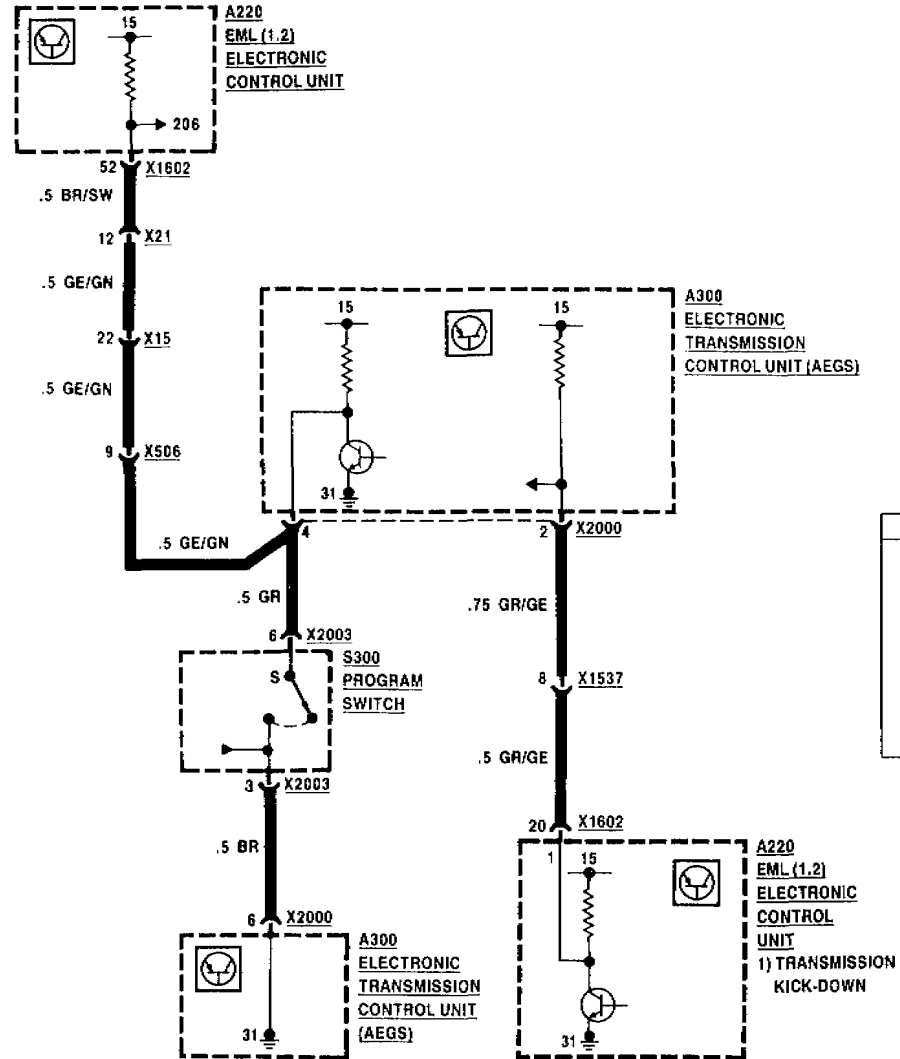



ELECTRONIC THROTTLE CONTROL (EML 1.2)

750iL

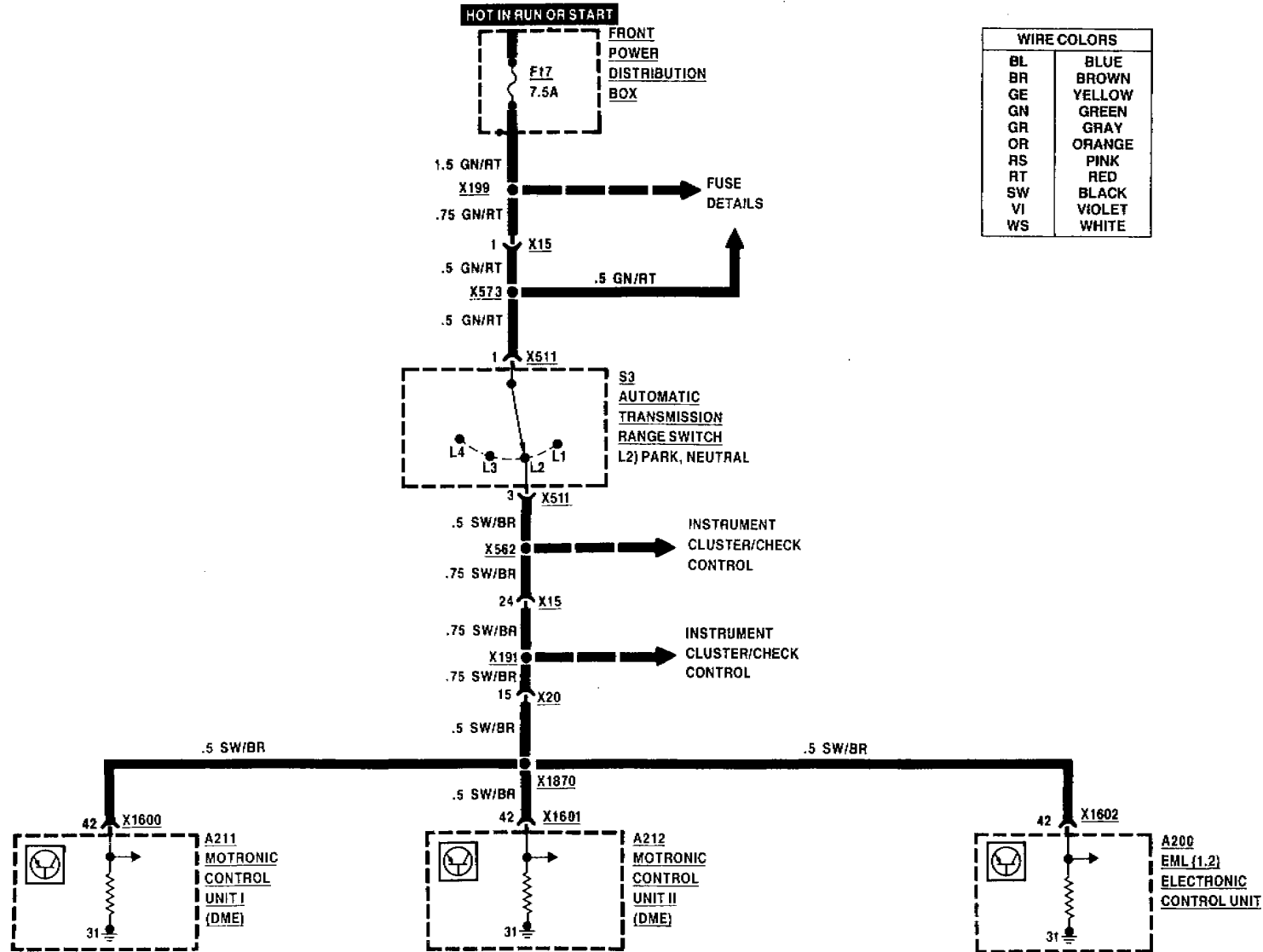



ELECTRONIC THROTTLE CONTROL (EML 1.2)

750iL

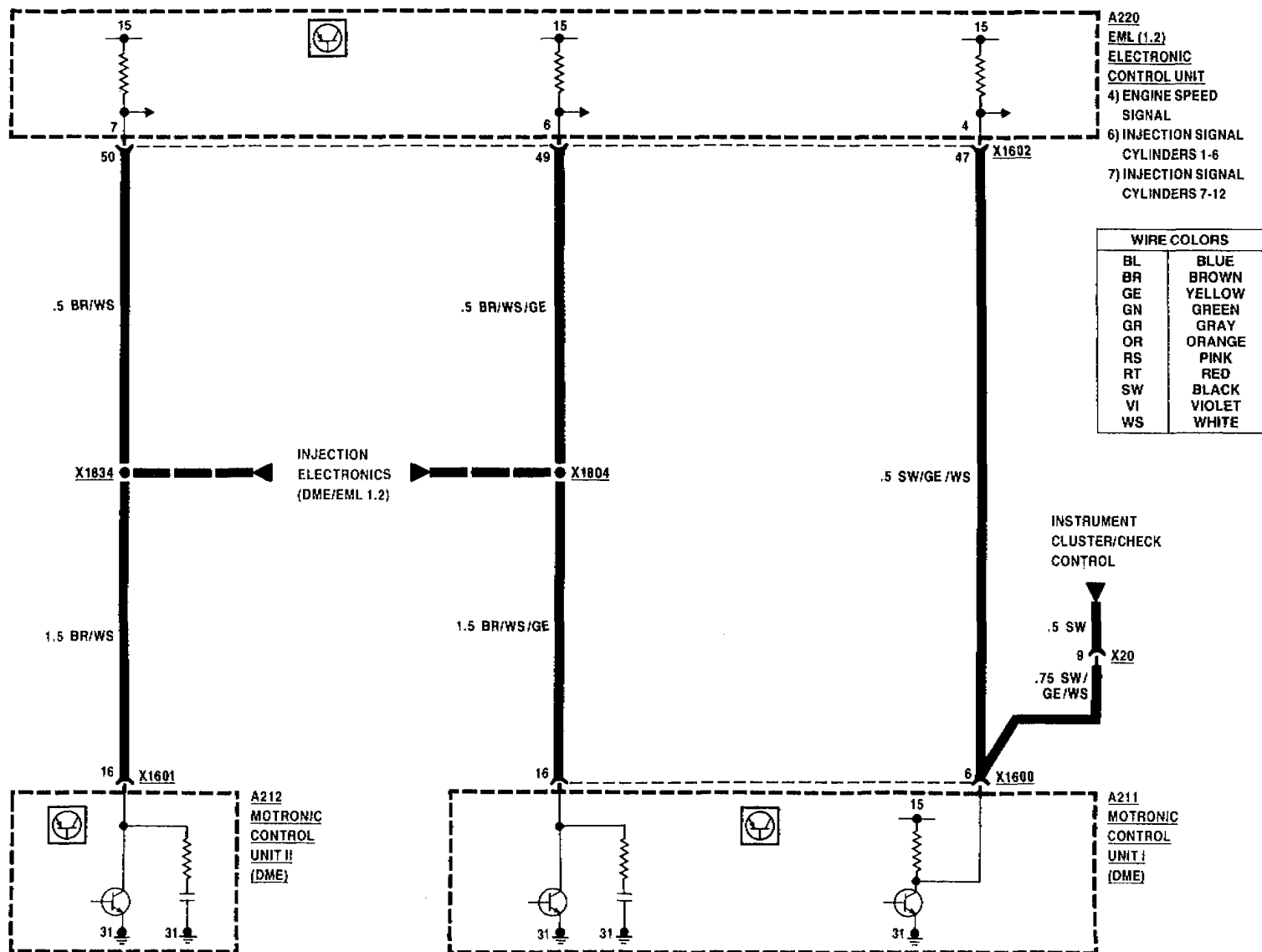



ELECTRONIC THROTTLE CONTROL (EML 1.2)

750iL

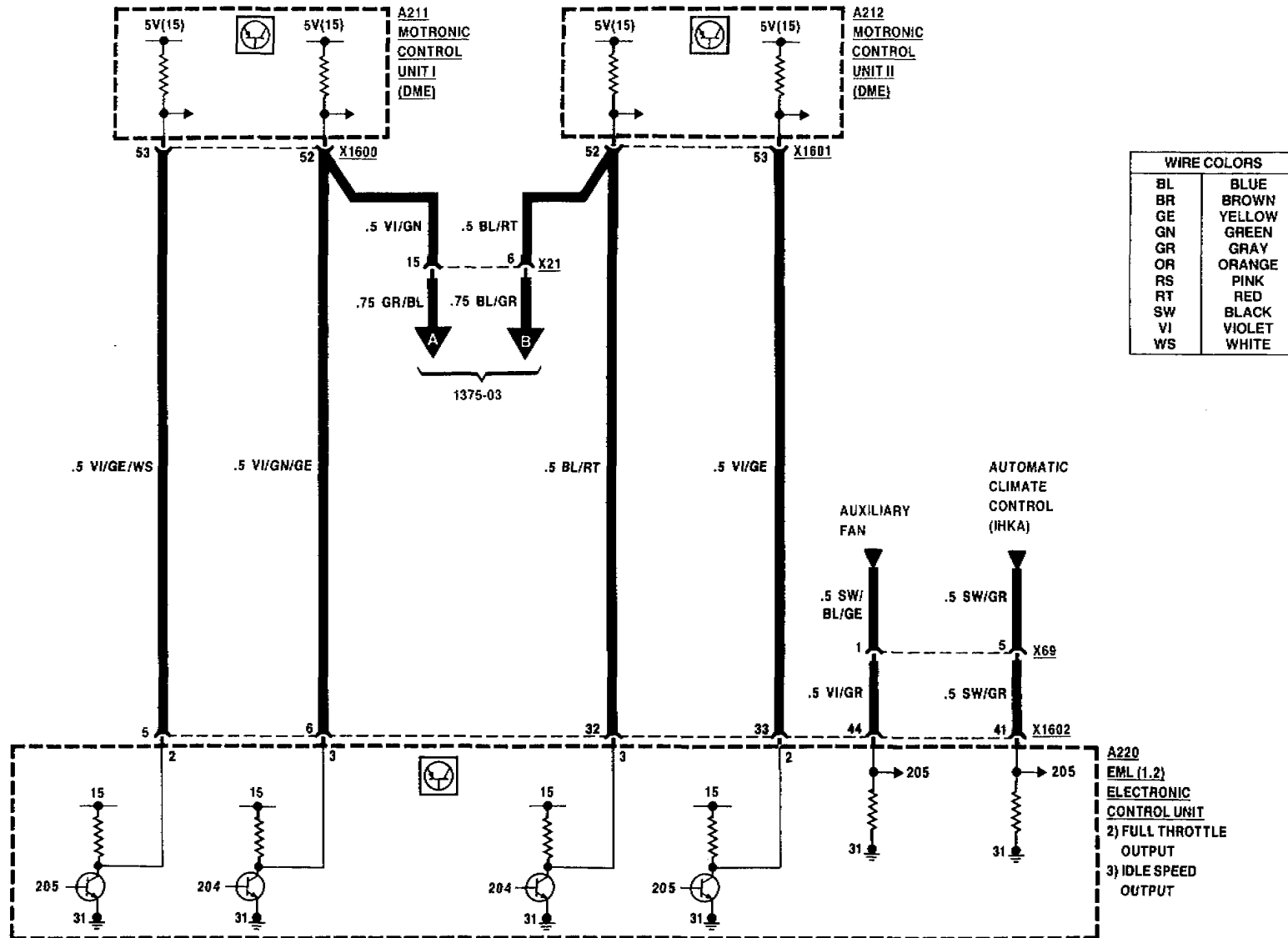

WIRE COLORS	
BL	BLUE
BR	BROWN
GE	YELLOW
GN	GREEN
GR	GRAY
OR	ORANGE
RS	PINK
RT	RED
SW	BLACK
VI	VIOLET
WS	WHITE



ELECTRONIC THROTTLE CONTROL (EML 1.2)

750iL

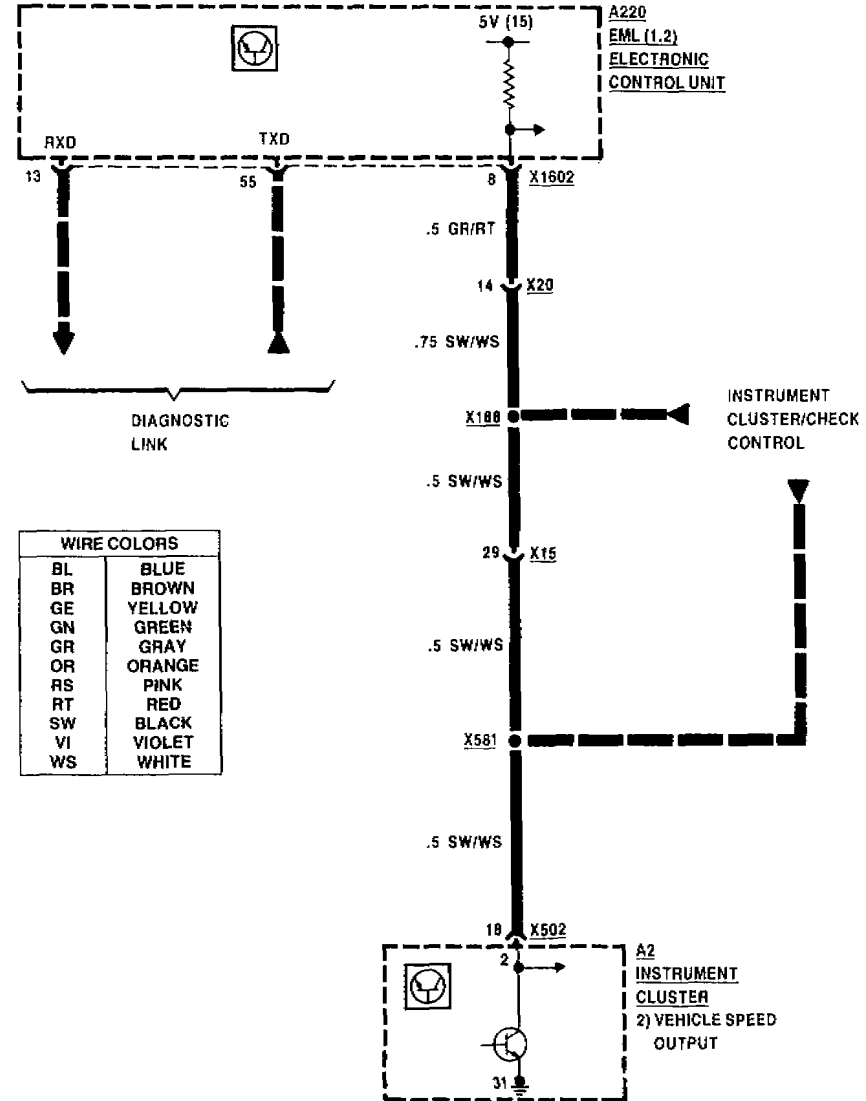
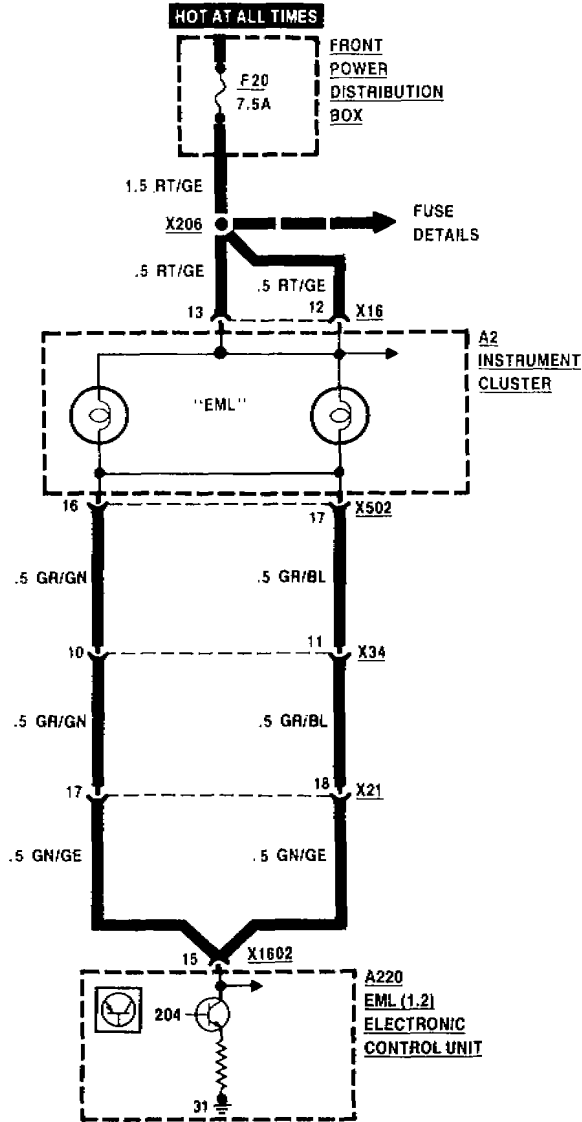



ELECTRONIC THROTTLE CONTROL (EML 1.2)

750iL

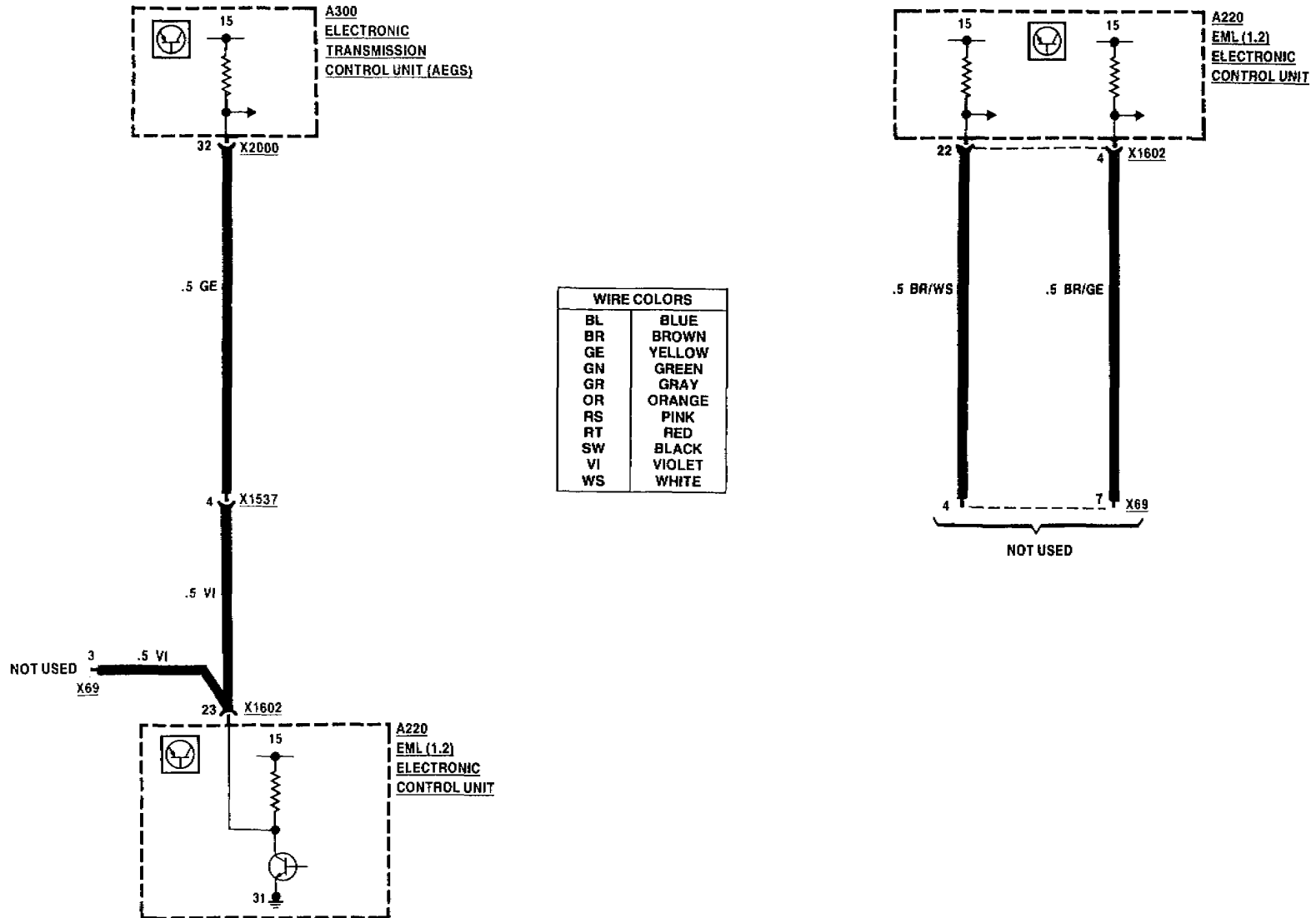



ELECTRONIC TRANSMISSION CONTROL (AEGS)

735i, 735iL

09/88

2460-00

1989

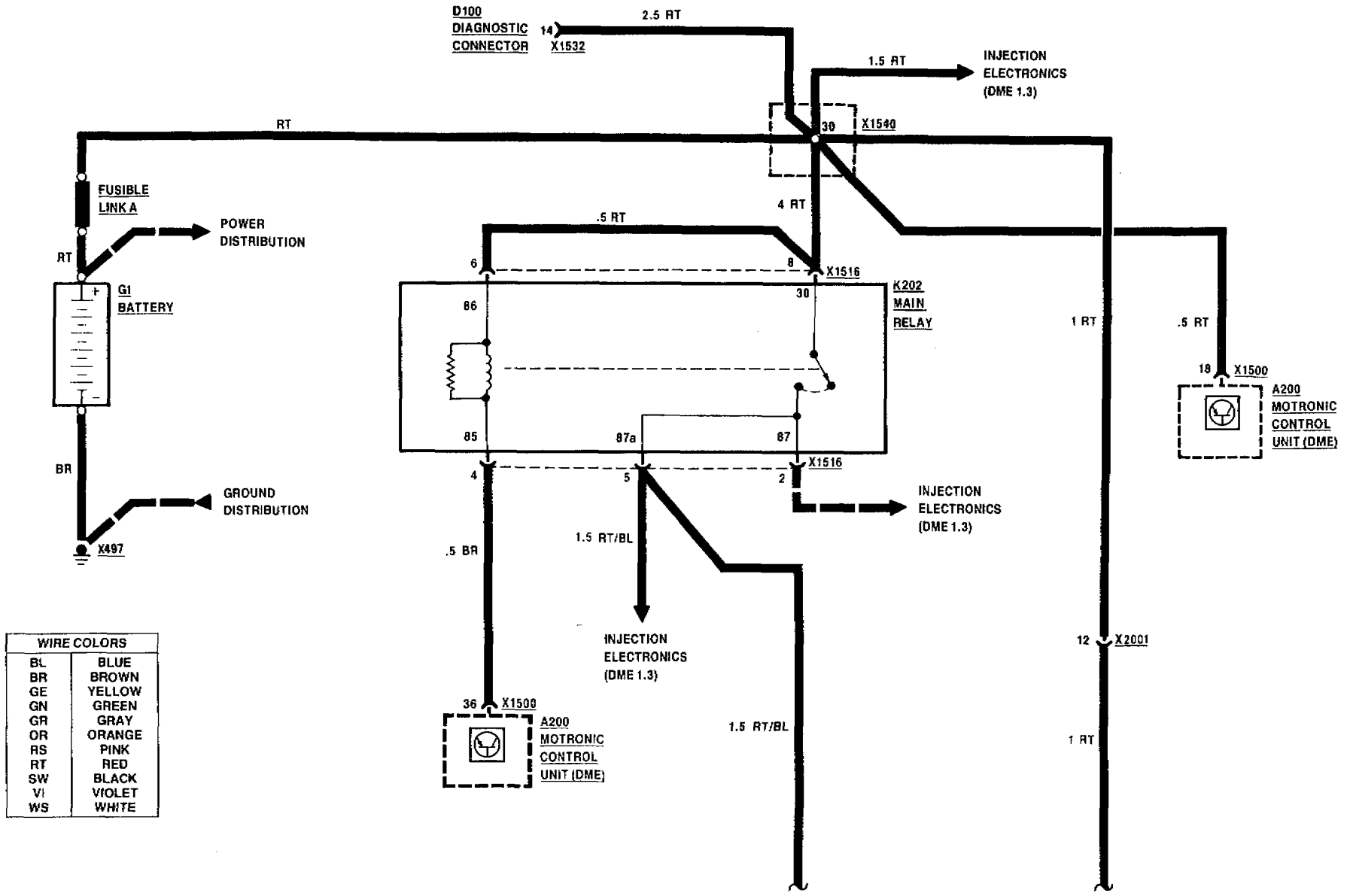

WIRE COLORS	
BL	BLUE
BR	BROWN
GE	YELLOW
GN	GREEN
GR	GRAY
OR	ORANGE
RS	PINK
RT	RED
SW	BLACK
VI	VIOLET
WS	WHITE

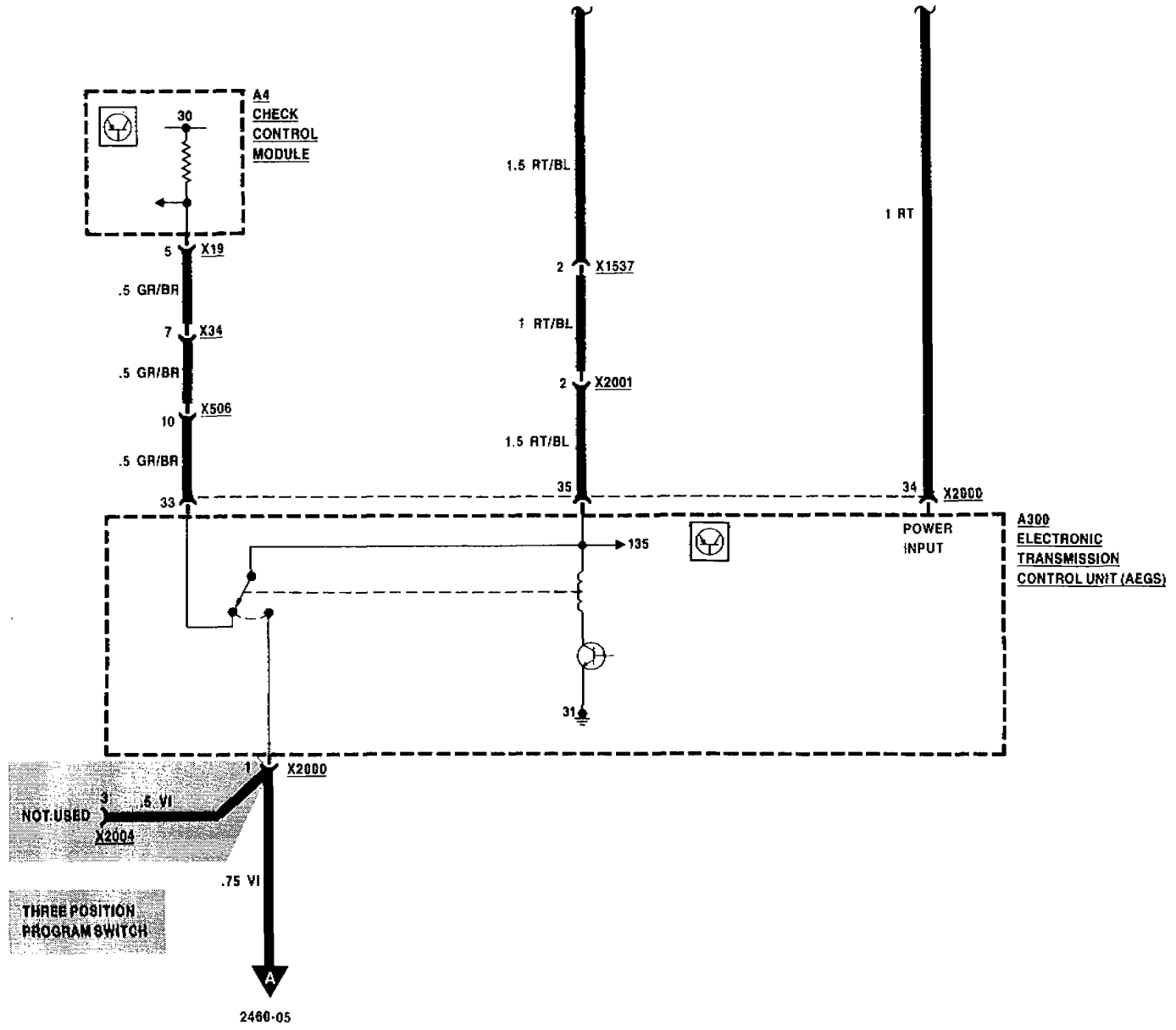

2460-05



ELECTRONIC TRANSMISSION CONTROL (AEGS)

735i, 735iL

THREE POSITION PROGRAM SWITCH

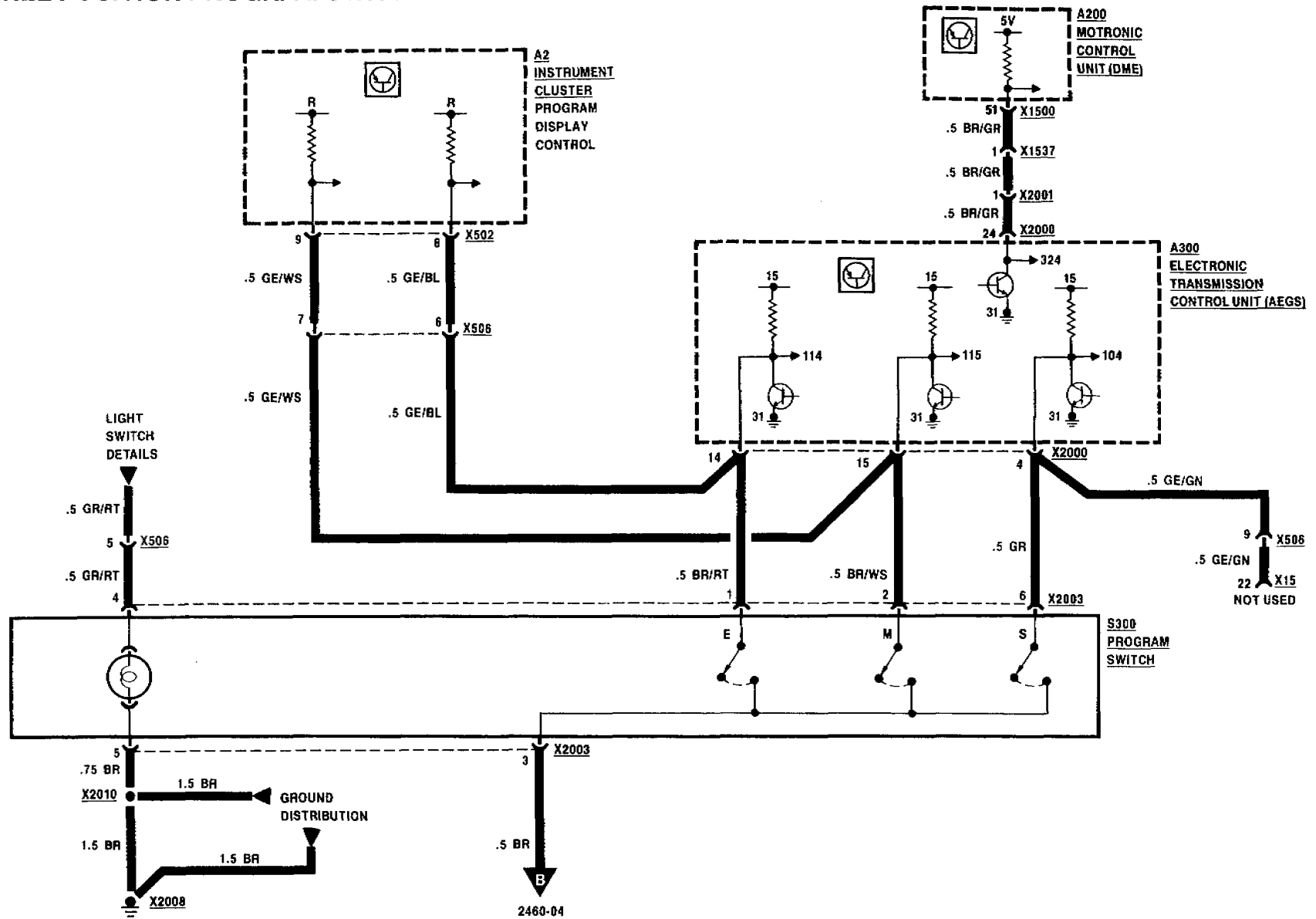

2460-04

09/88

2460-02

1989



ELECTRONIC TRANSMISSION CONTROL (AEGS)

735i, 735iL

TWO POSITION PROGRAM SWITCH

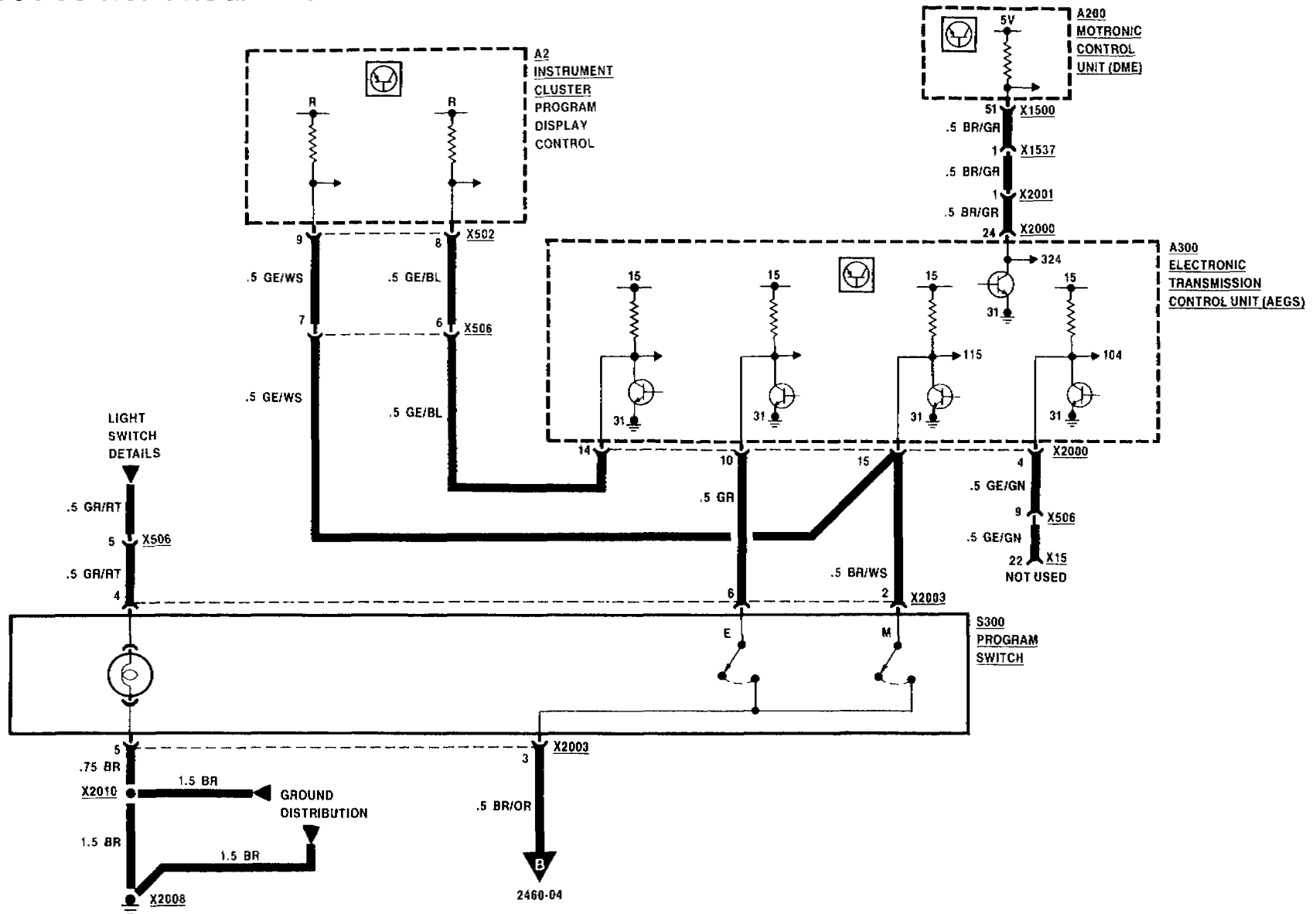

WIRE COLORS	
BL	BLUE
BR	BROWN
GE	YELLOW
GN	GREEN
GR	GRAY
OR	ORANGE
RS	PINK
RT	RED
SW	BLACK
VI	VIOLET
WS	WHITE

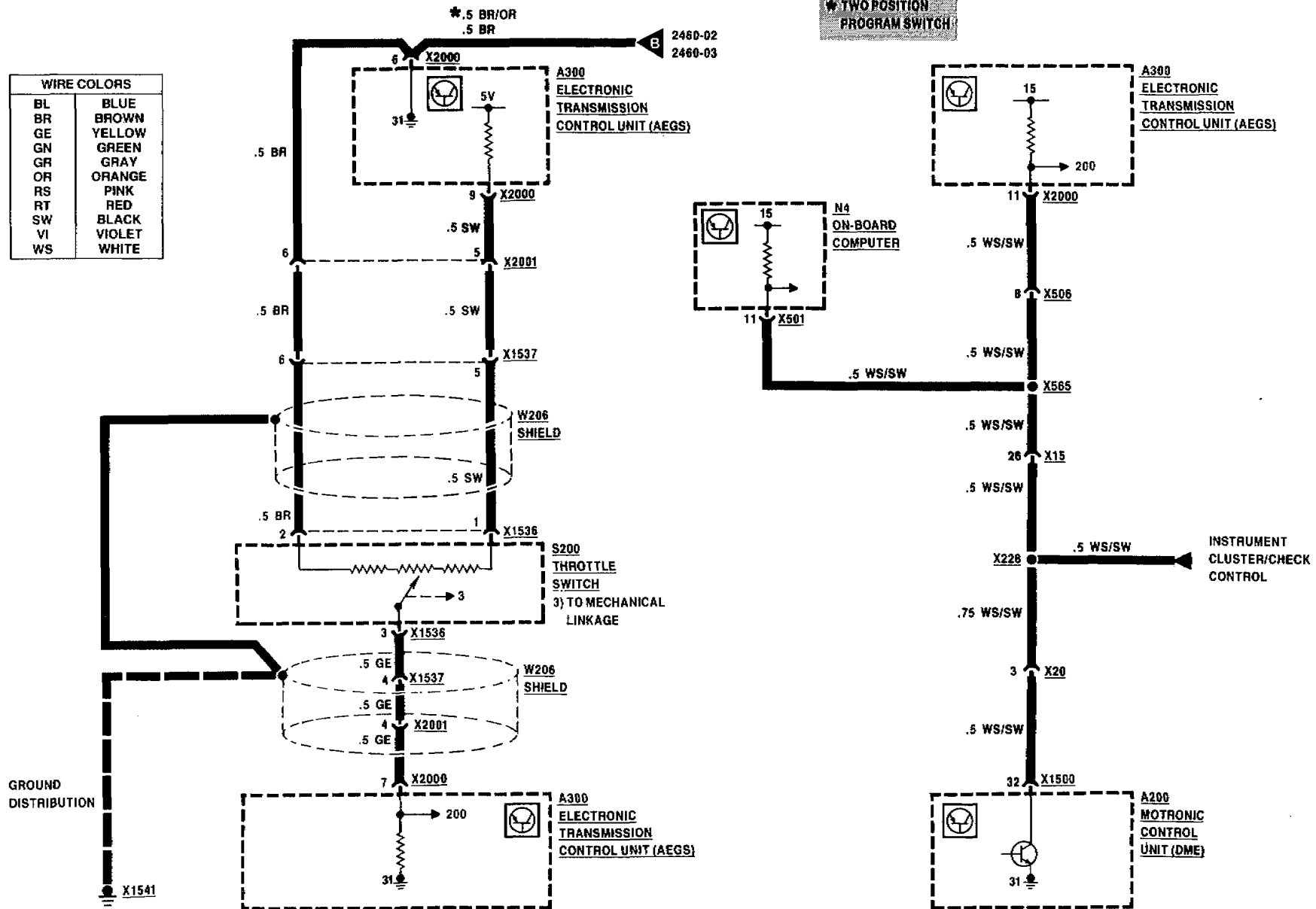



ELECTRONIC TRANSMISSION CONTROL (AEGS)

735i, 735iL

09/88 ————— 2460-05 ————— 1989

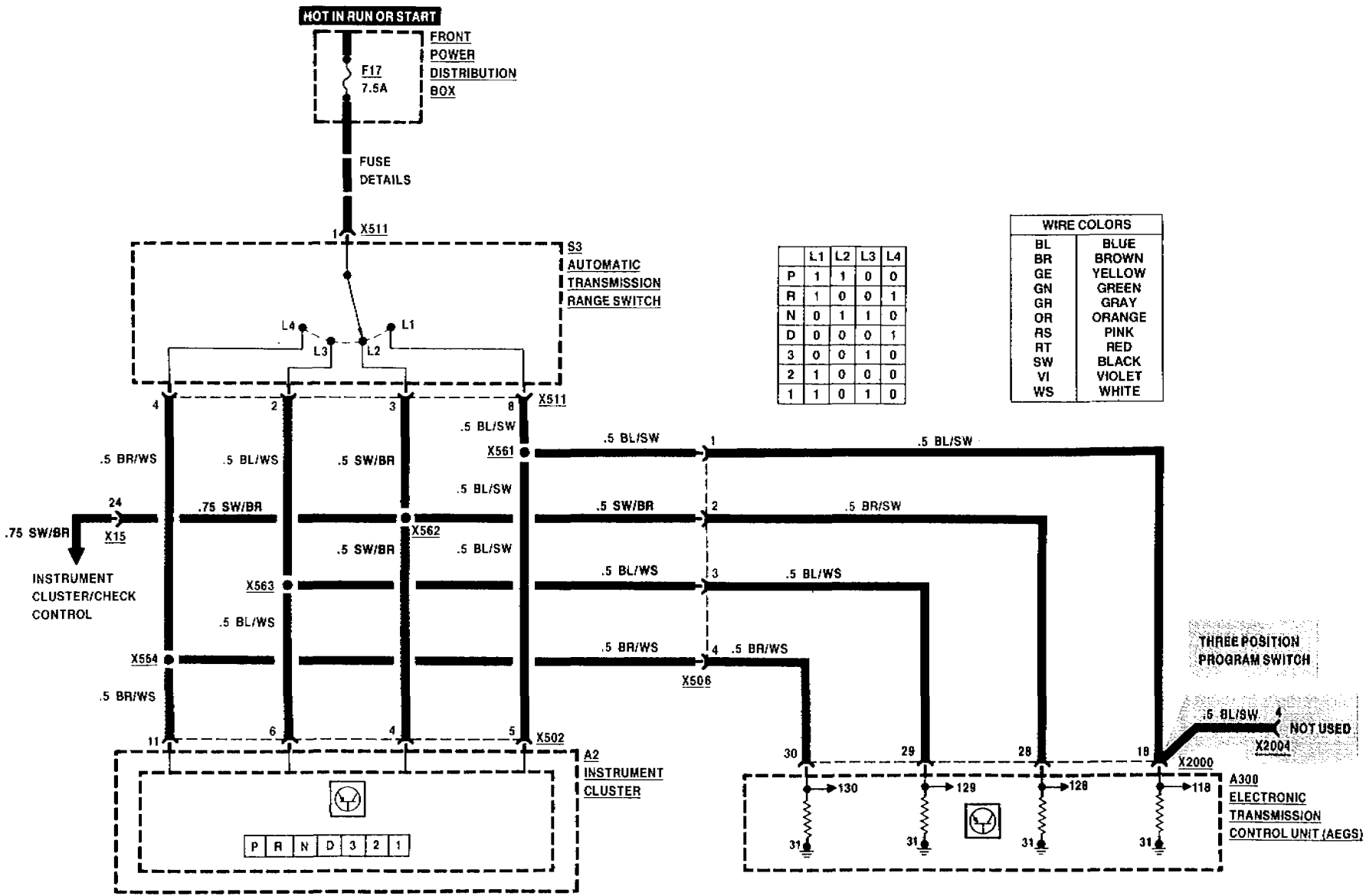



ELECTRONIC TRANSMISSION CONTROL (AEGS)

735i, 735iL

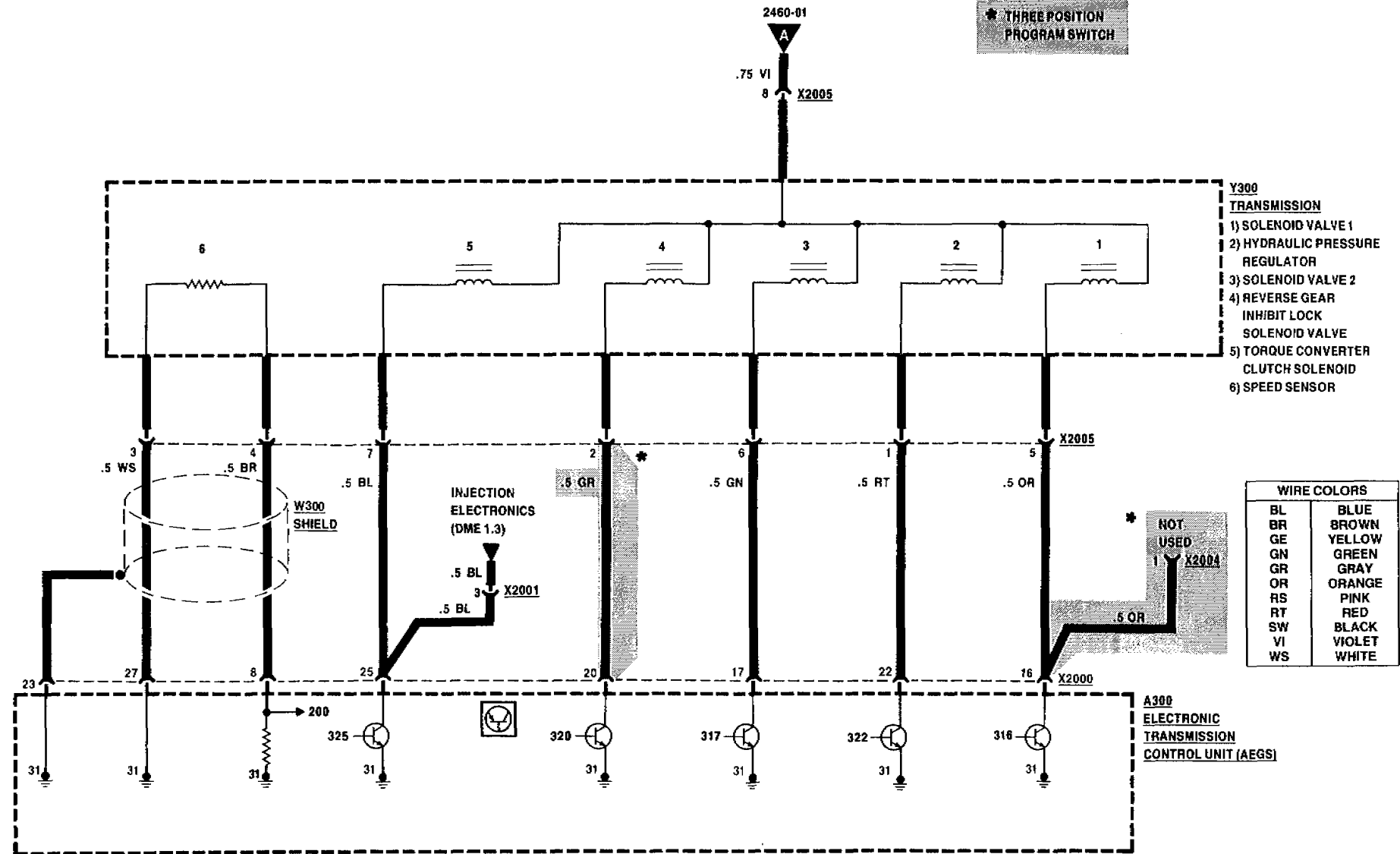



ELECTRONIC TRANSMISSION CONTROL (AEGS/EML)

750iL

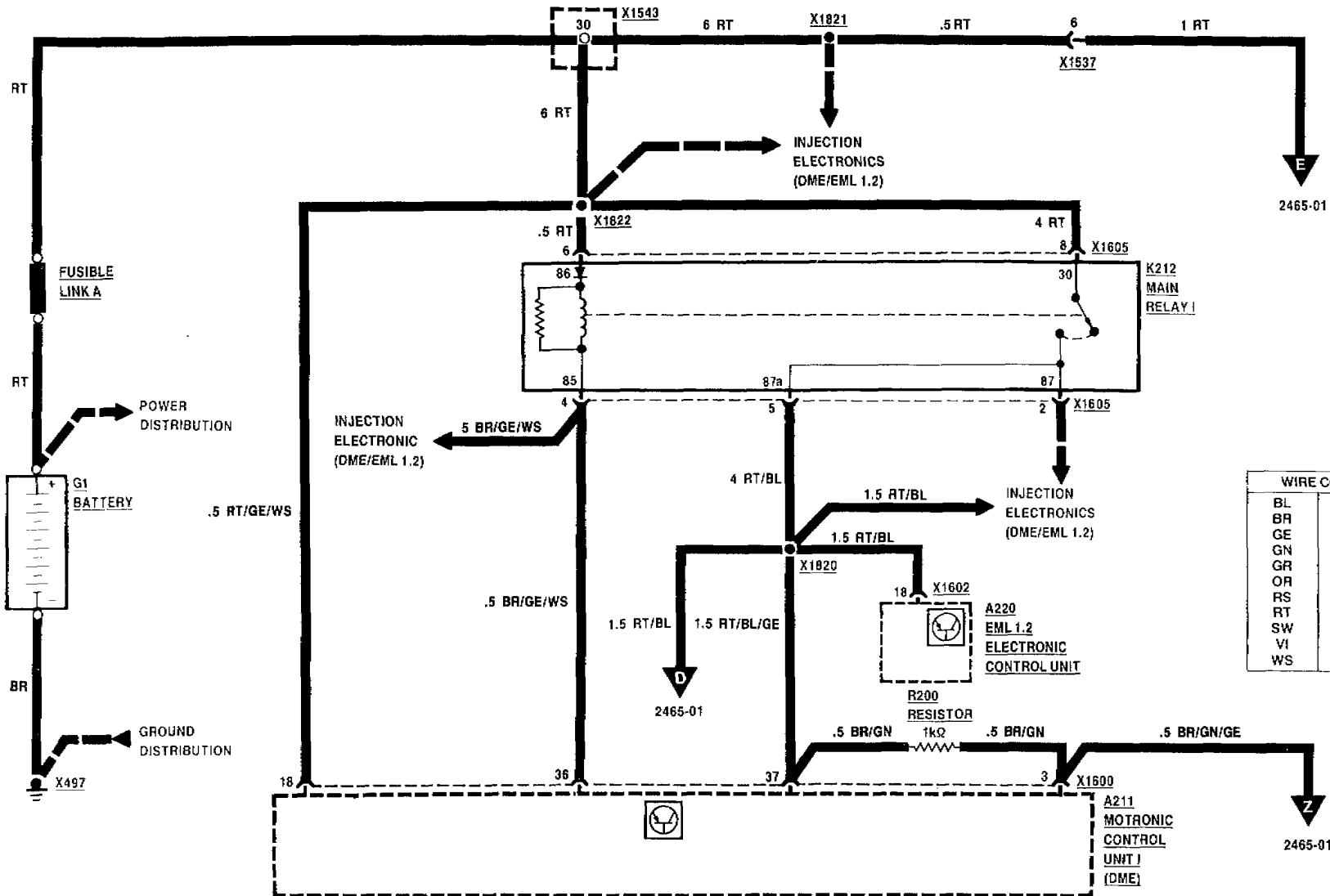

WIRE COLORS	
BL	BLUE
BR	BROWN
GE	YELLOW
GN	GREEN
GR	GRAY
OR	ORANGE
RS	PINK
RT	RED
SW	BLACK
VI	VIOLET
WS	WHITE

11/89

2465-00

1989



ELECTRONIC TRANSMISSION CONTROL (AEGS/EML)

750iL

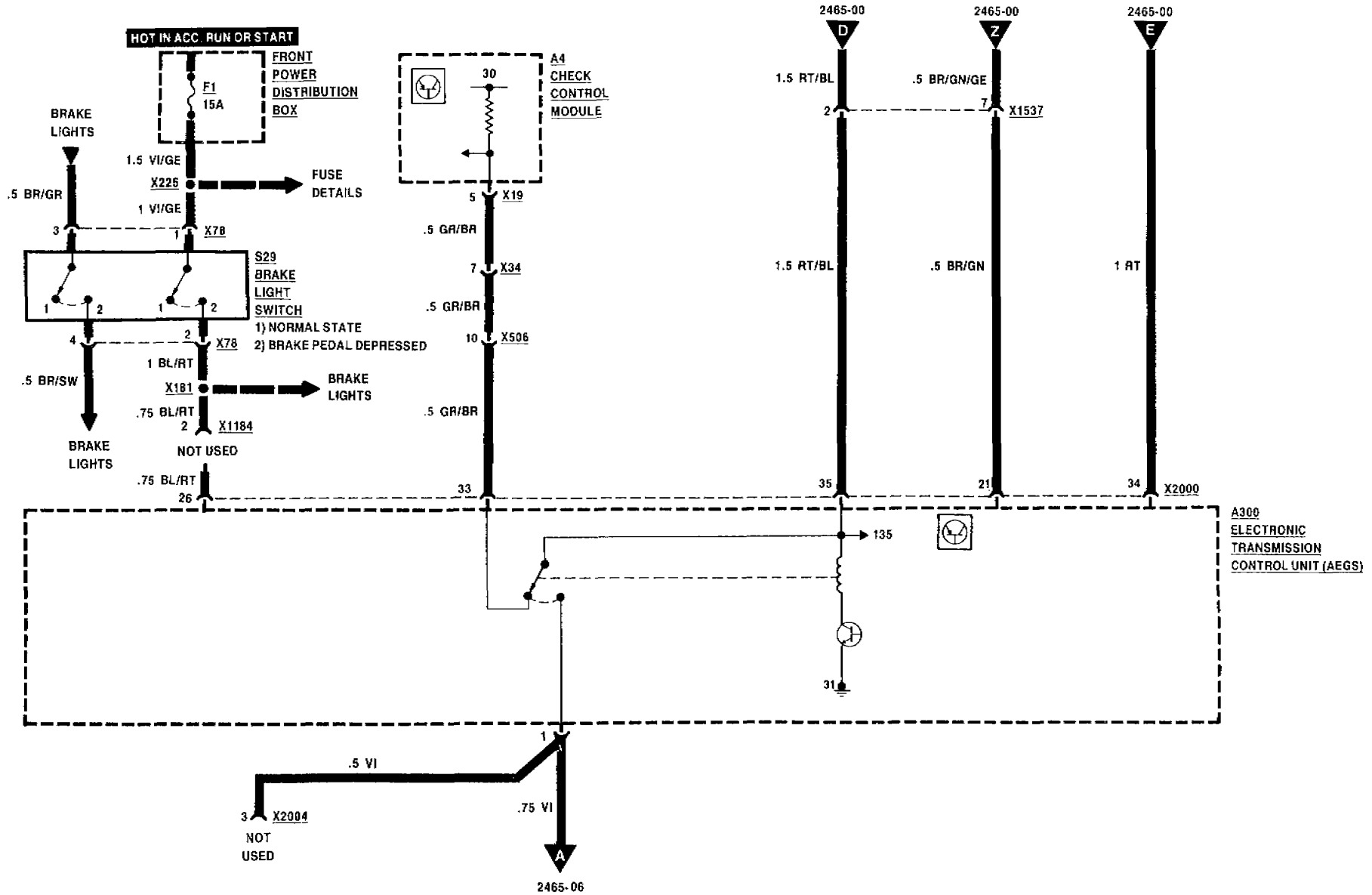



ELECTRONIC TRANSMISSION CONTROL (AEGS/EML)

750iL

THREE POSITION PROGRAM SWITCH

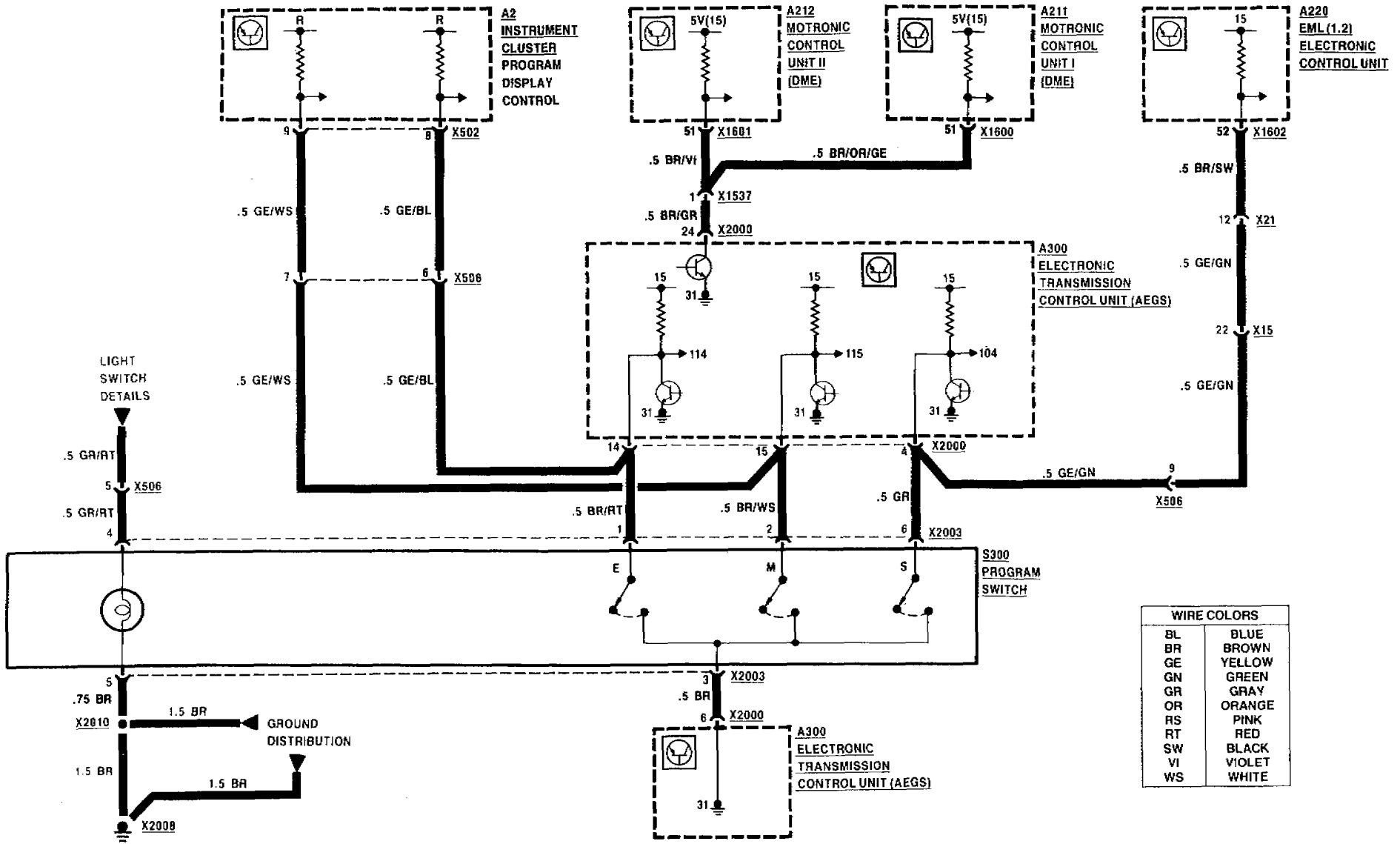



ELECTRONIC TRANSMISSION CONTROL (AEGS/EML)

750iL

TWO POSITION PROGRAM SWITCH

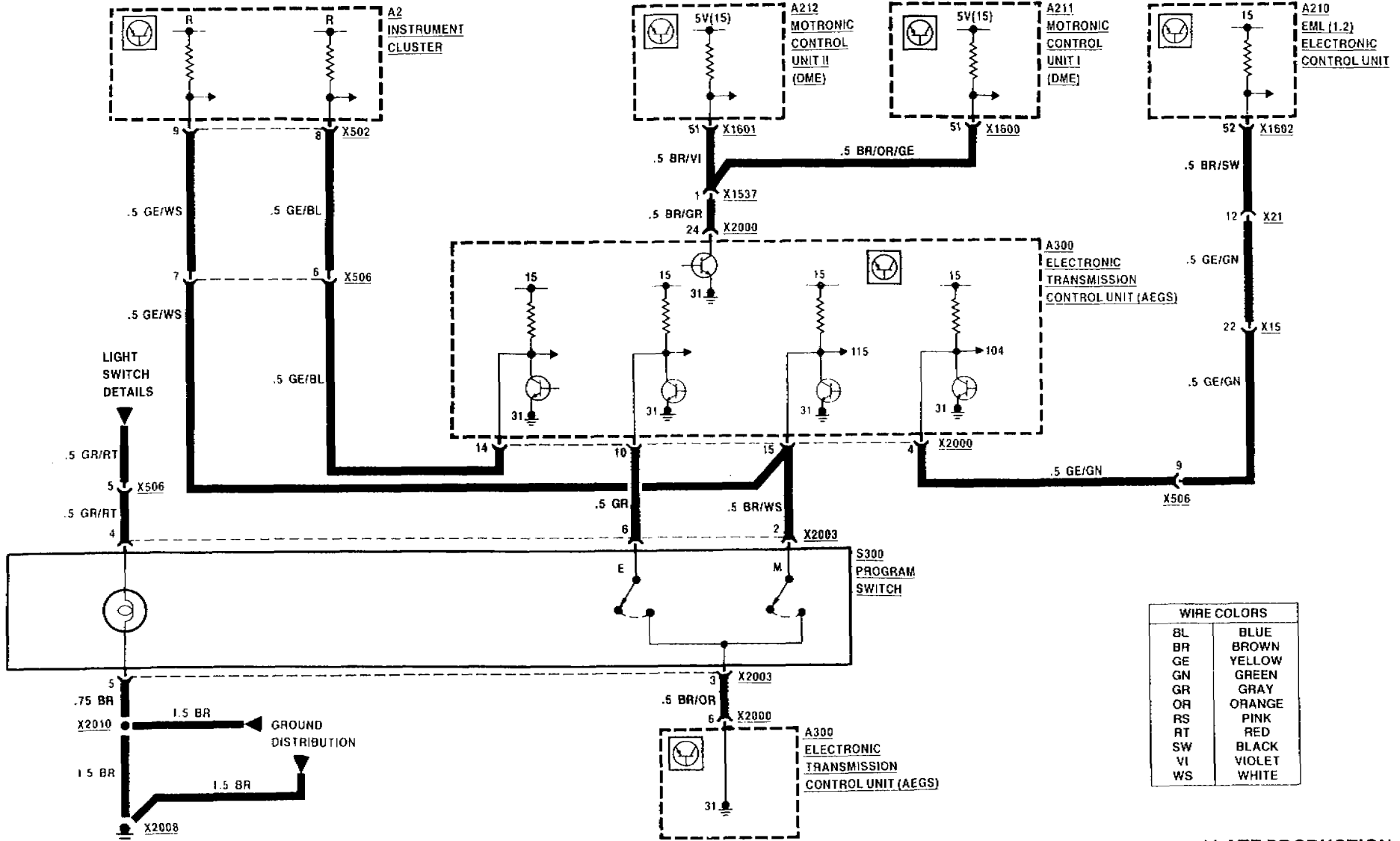

*LATE PRODUCTION



ELECTRONIC TRANSMISSION CONTROL (AEGS/EML)

750iL

09/88

2465-04

1989

WIRE COLORS	
BL	BLUE
BR	BROWN
GE	YELLOW
GN	GREEN
GR	GRAY
OR	ORANGE
RS	PINK
RT	RED
SW	BLACK
VI	VIOLET
WS	WHITE

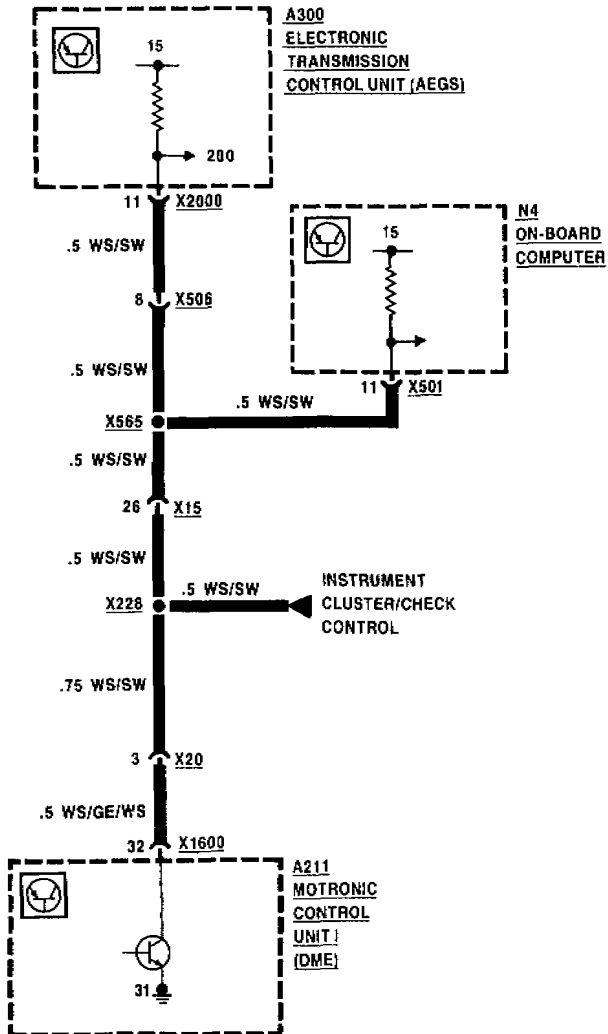



ELECTRONIC TRANSMISSION CONTROL (AEGS/EML)

750iL

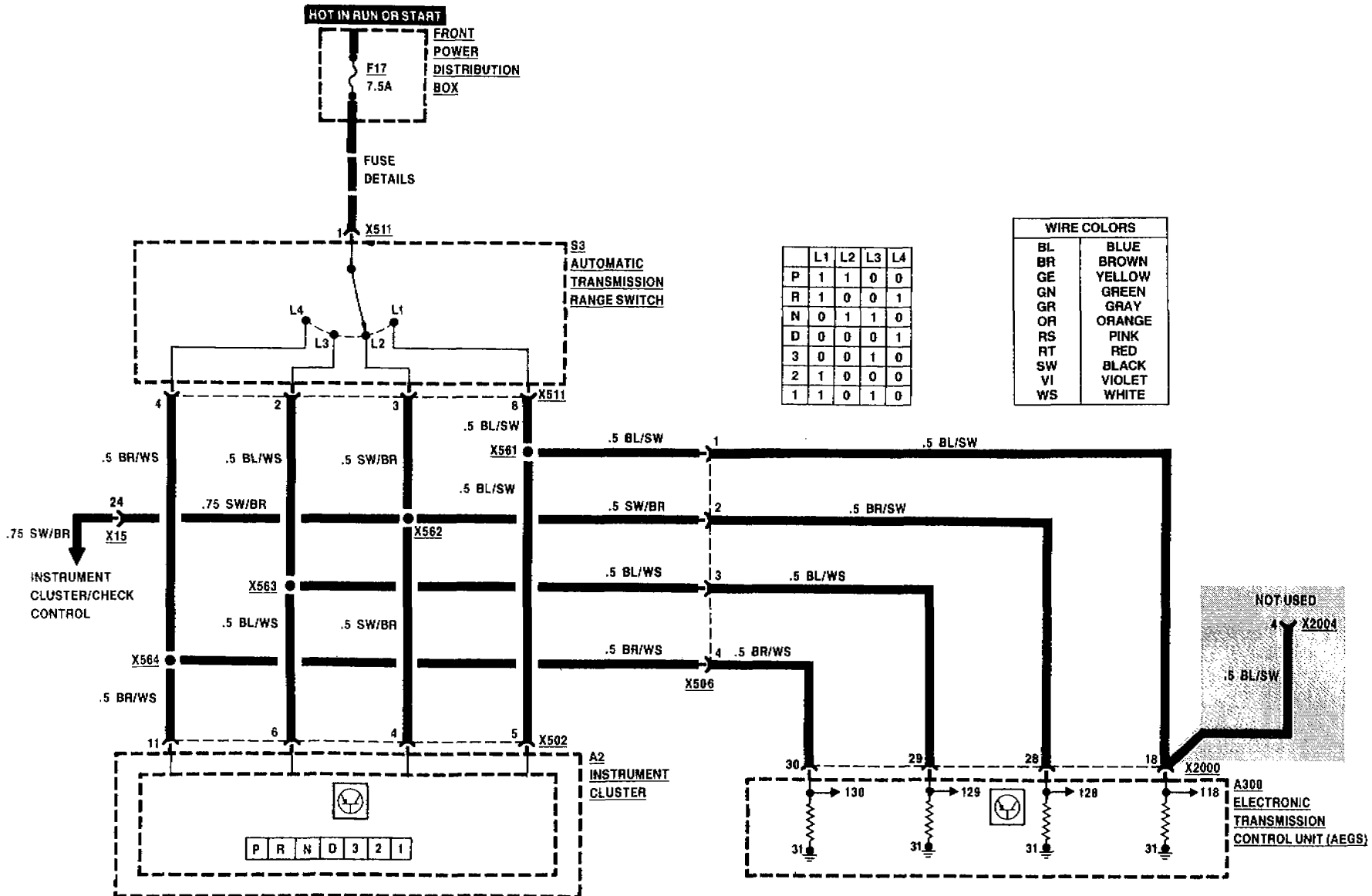

09/88

2465-05

1989



ELECTRONIC TRANSMISSION CONTROL (AEGS/EML)

750iL

09/88

2465-06

1989

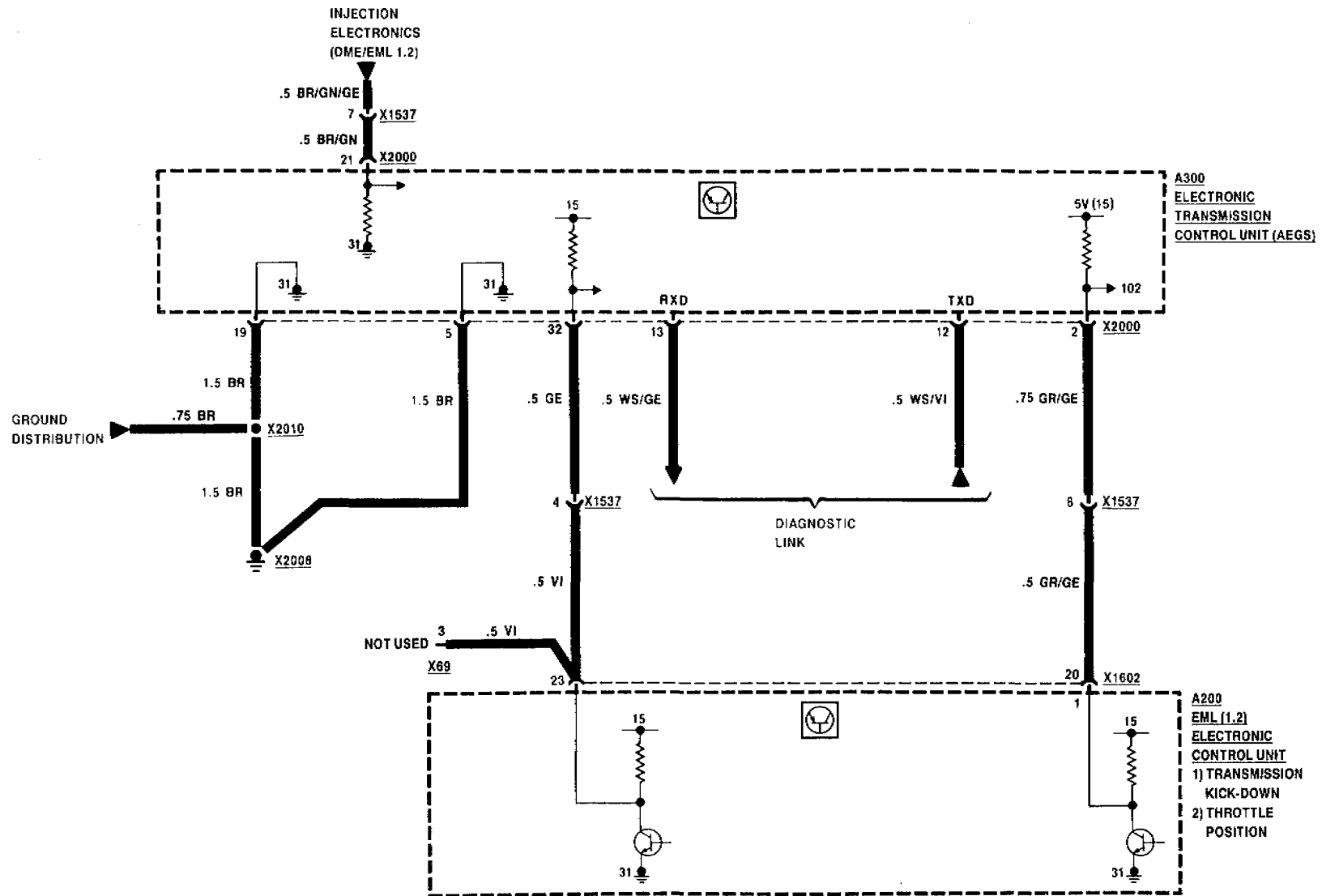



ELECTRONIC TRANSMISSION CONTROL (AEGS/EML)

750iL

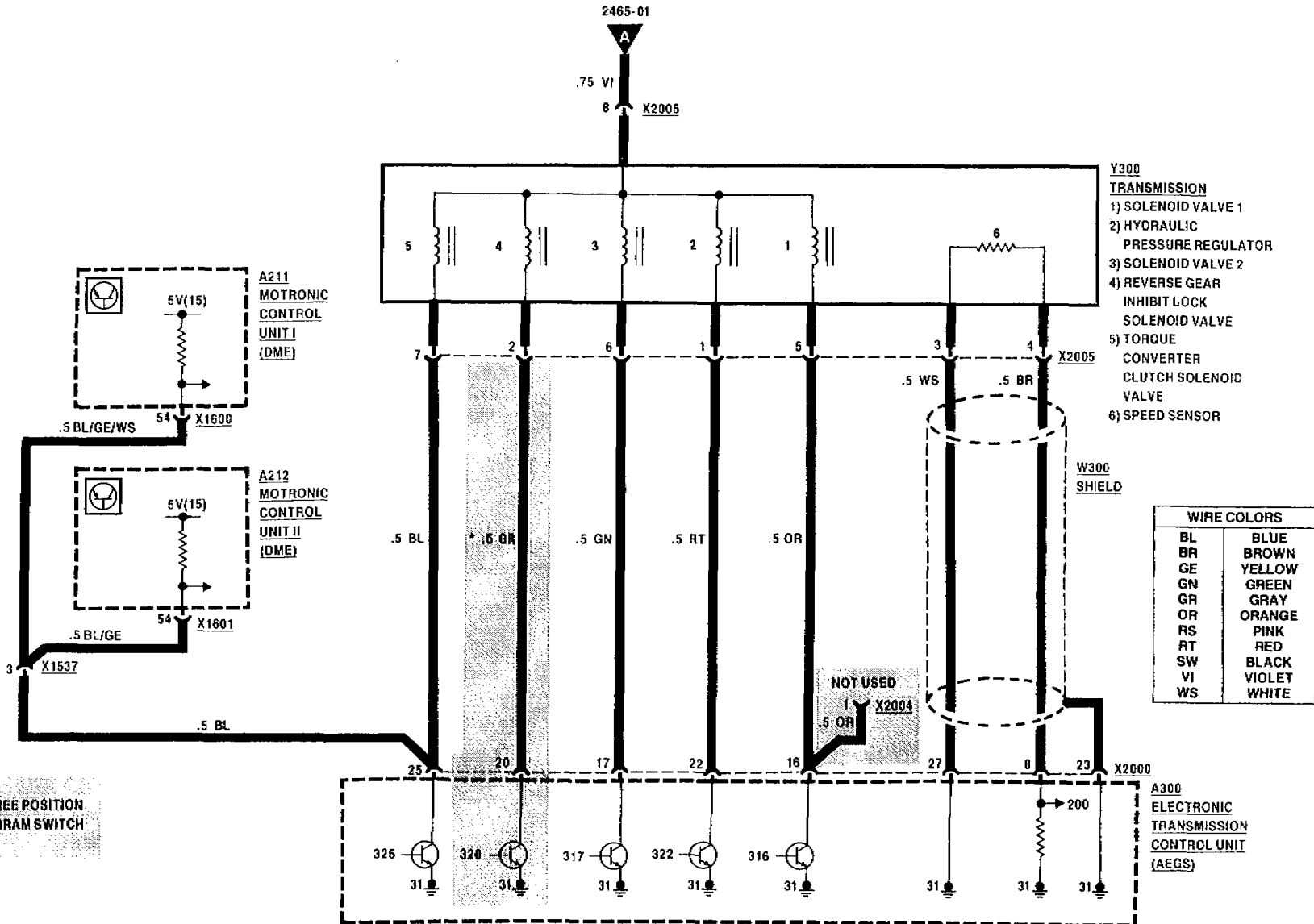



SUPPLEMENTAL RESTRAINT SYSTEM (AIR BAG)

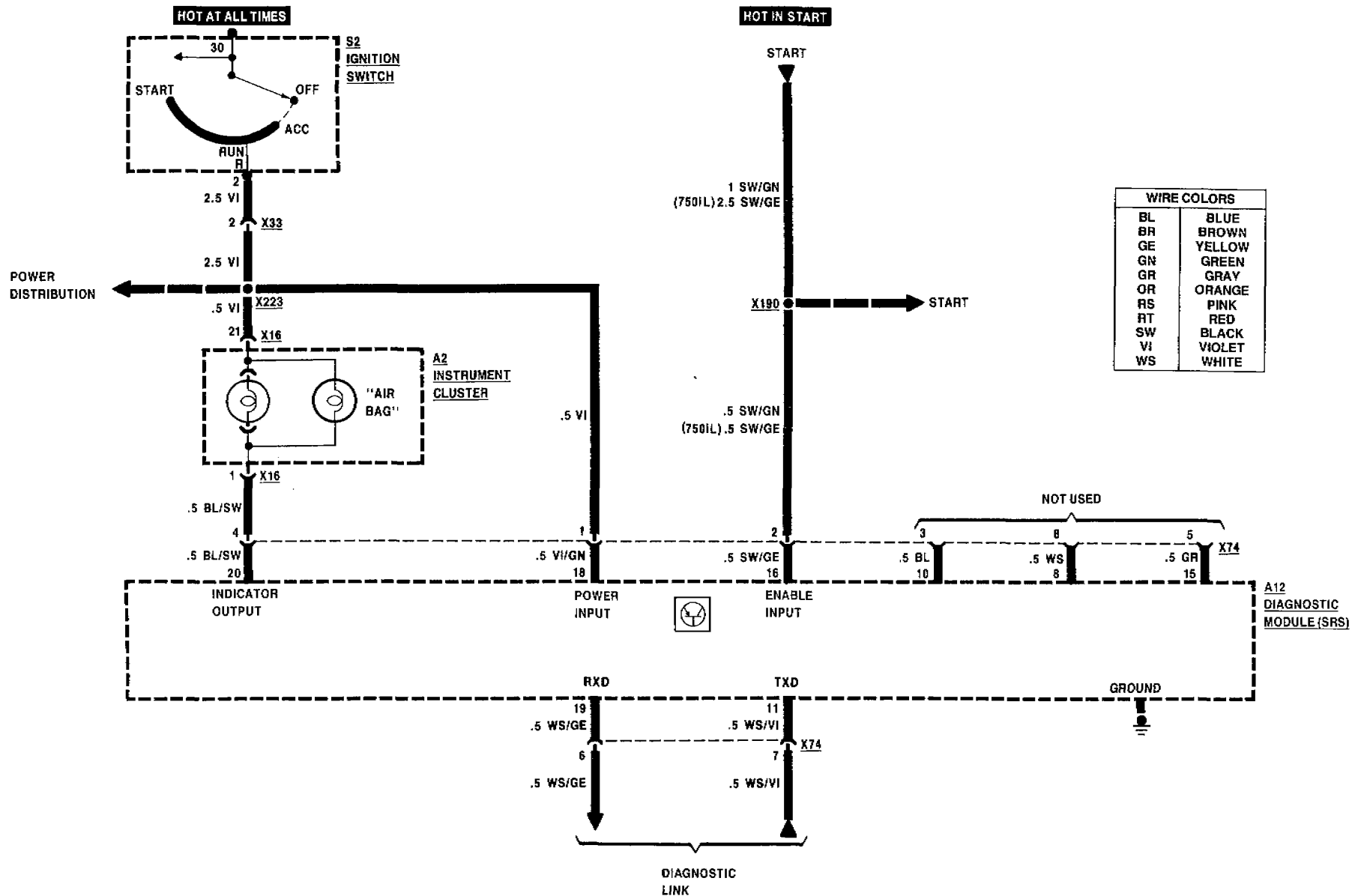

SUPPLEMENTAL RESTRAINT SYSTEM (AIR BAG)

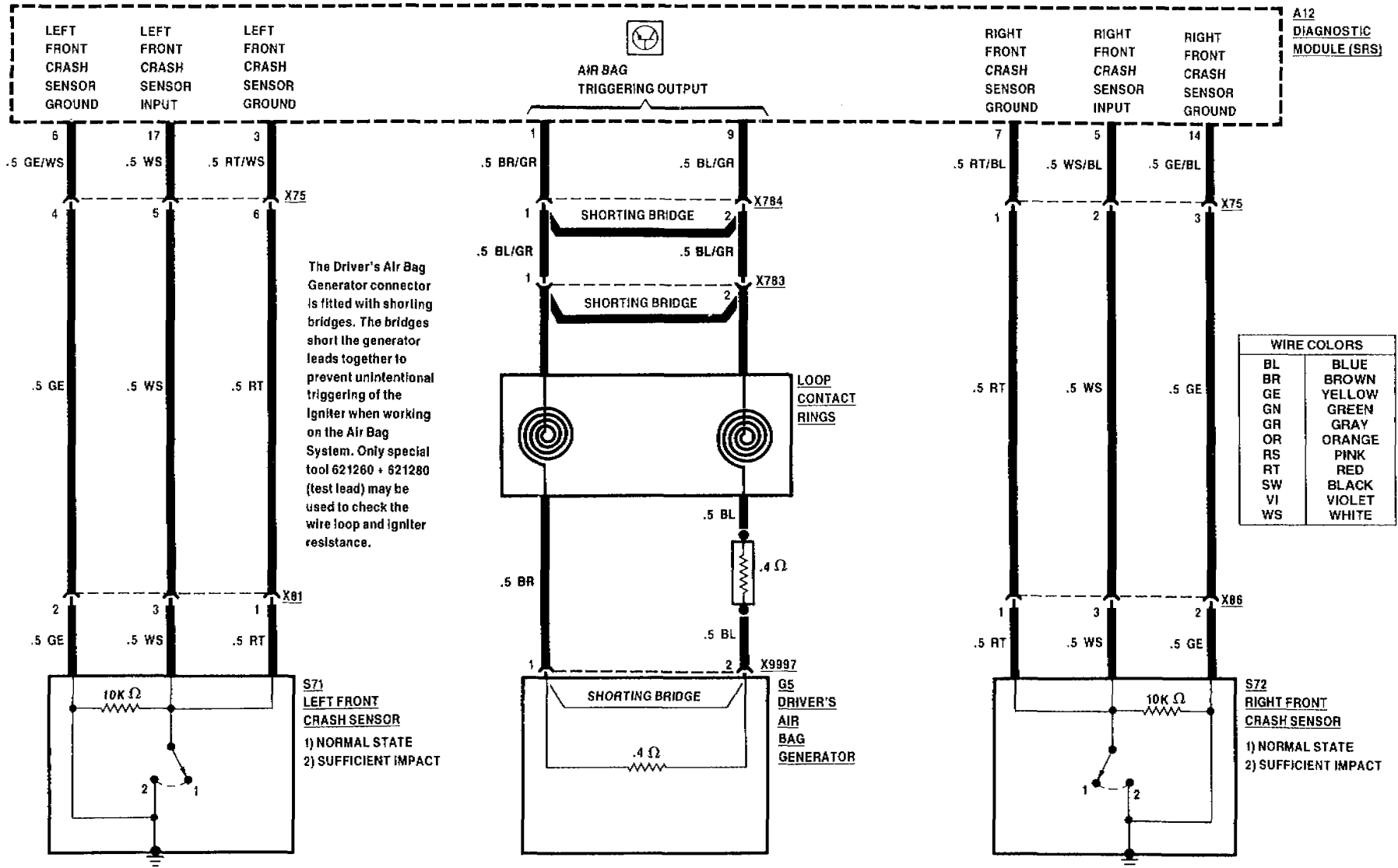



POWER ASSIST STEERING (SERVOTRONIC)

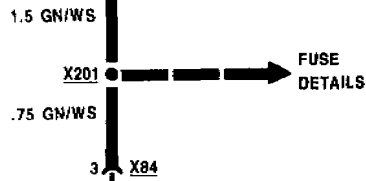
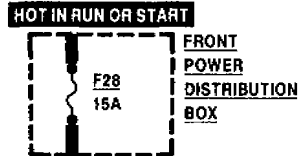

WIRE COLORS	
BL	BLUE
BR	BROWN
GE	YELLOW
GN	GREEN
GR	GRAY
OR	ORANGE
RS	PINK
RT	RED
SW	BLACK
VI	VIOLET
WS	WHITE

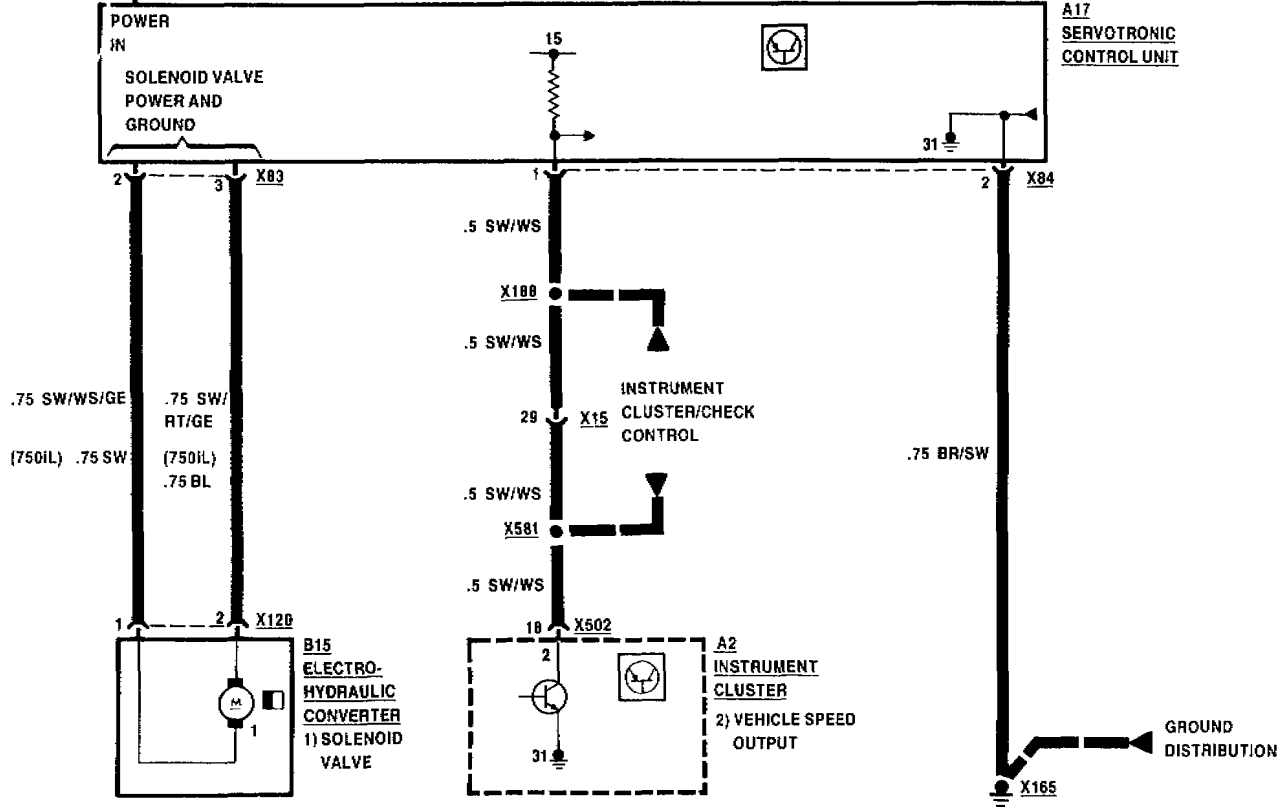



7 BRAKE LINING WARNING BRAKE WARNING LIGHT

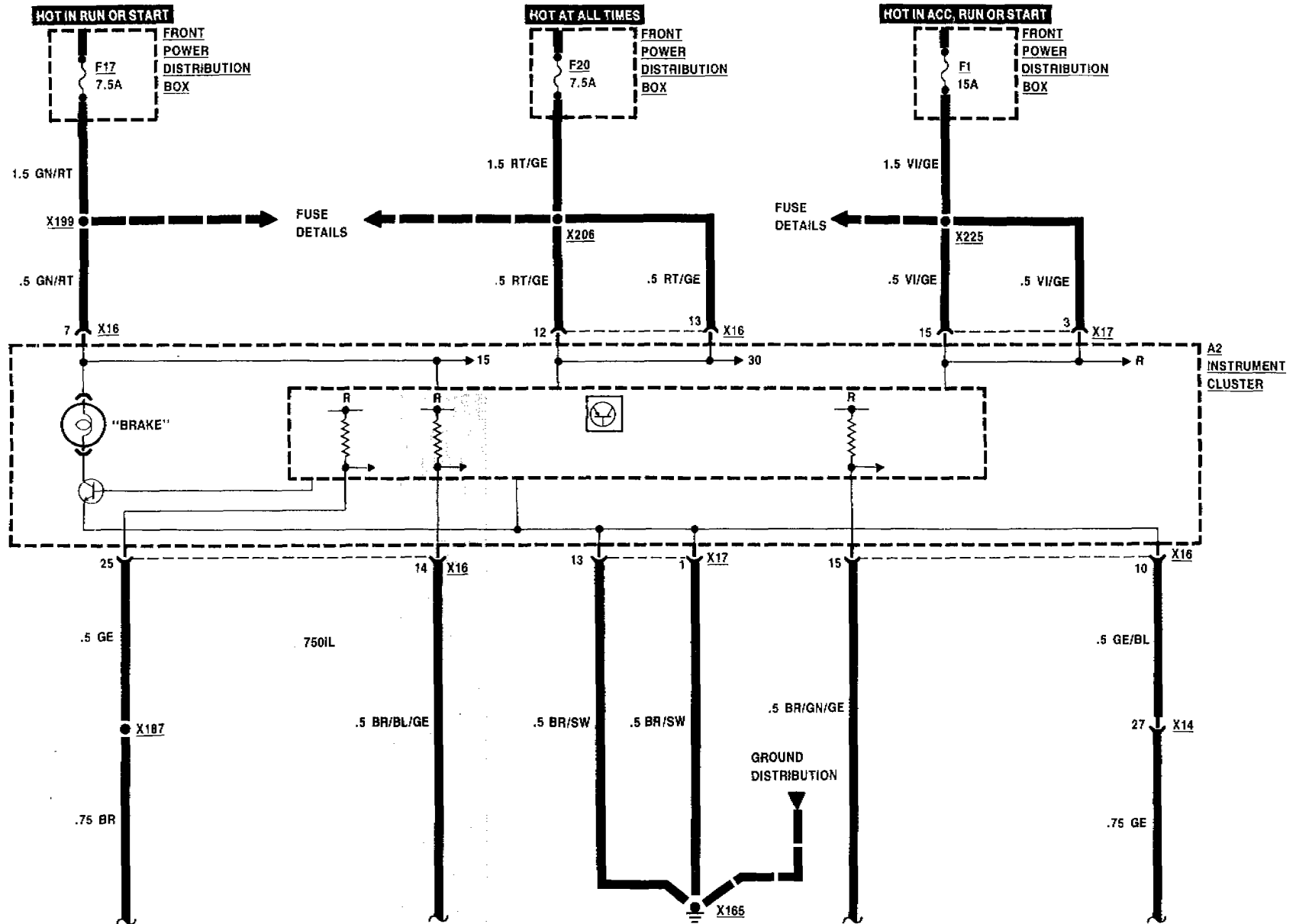

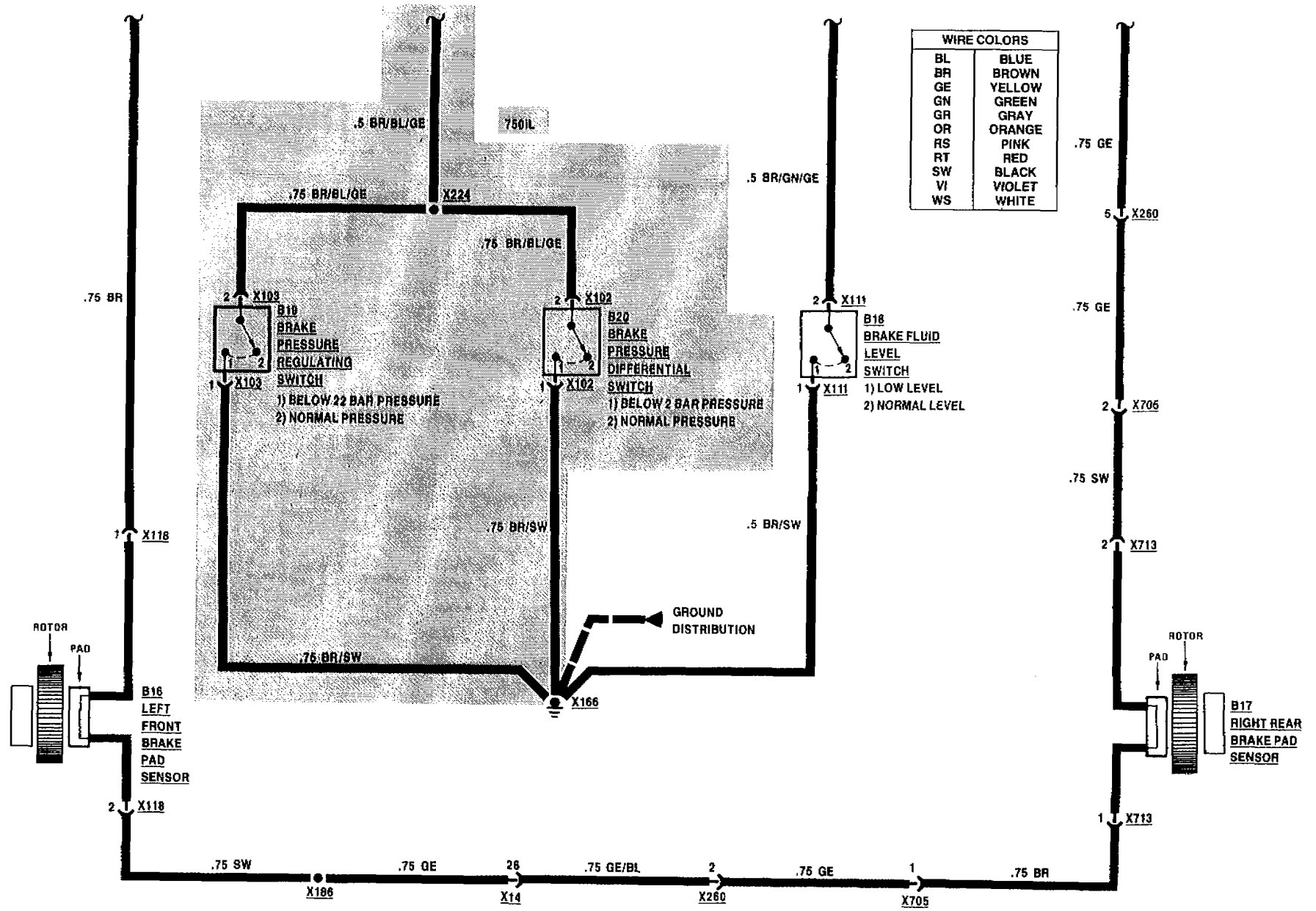

WIRE COLORS	
BL	BLUE
BR	BROWN
GE	YELLOW
GN	GREEN
GR	GRAY
OR	ORANGE
RS	PINK
RT	RED
SW	BLACK
VI	VIOLET
WS	WHITE

09/88
3435-01
1989



ANTILOCK BRAKE SYSTEM (ABS)

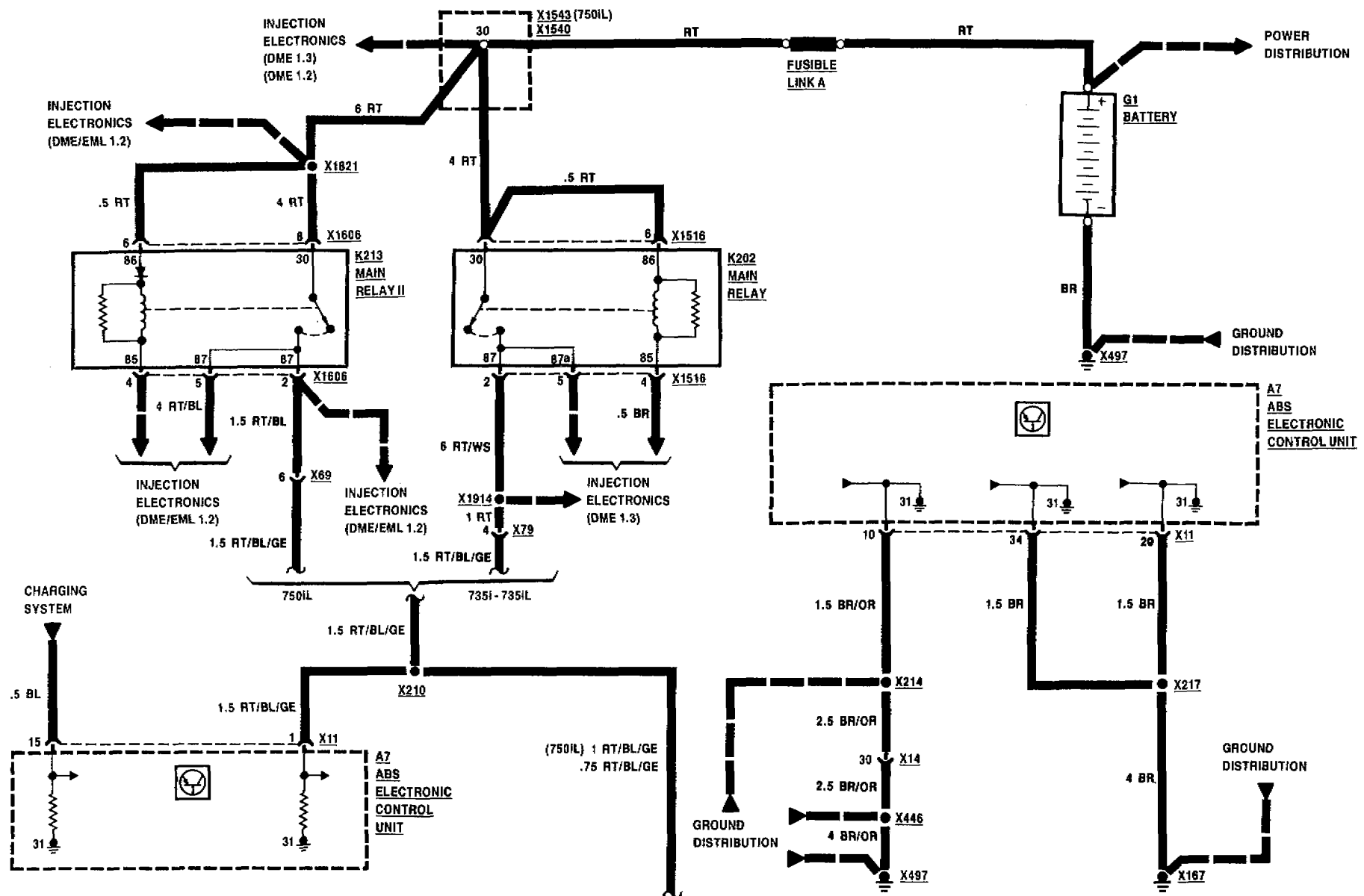

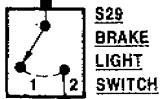
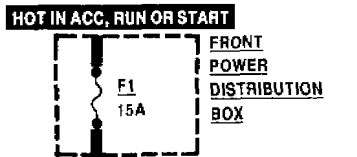

- 1) NORMAL STATE
- 2) BRAKE PEDAL DEPRESSED

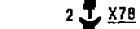

WIRE COLORS	
BL	BLUE
BR	BROWN
GE	YELLOW
GN	GREEN
GR	GRAY
OR	ORANGE
RS	PINK
RT	RED
SW	BLACK
VI	VIOLET
WS	WHITE

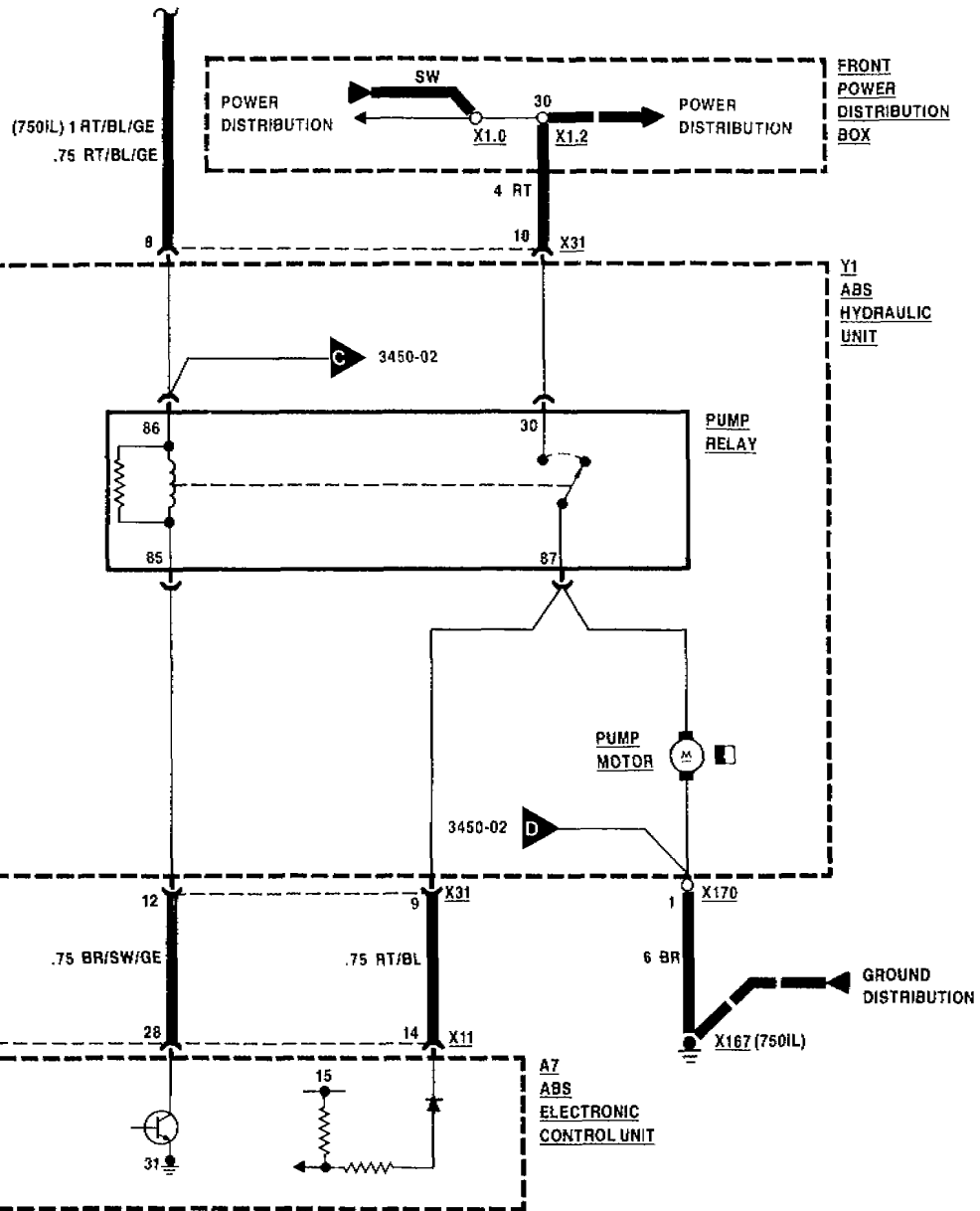



ANTILOCK BRAKE SYSTEM (ABS)

730i, 735iL

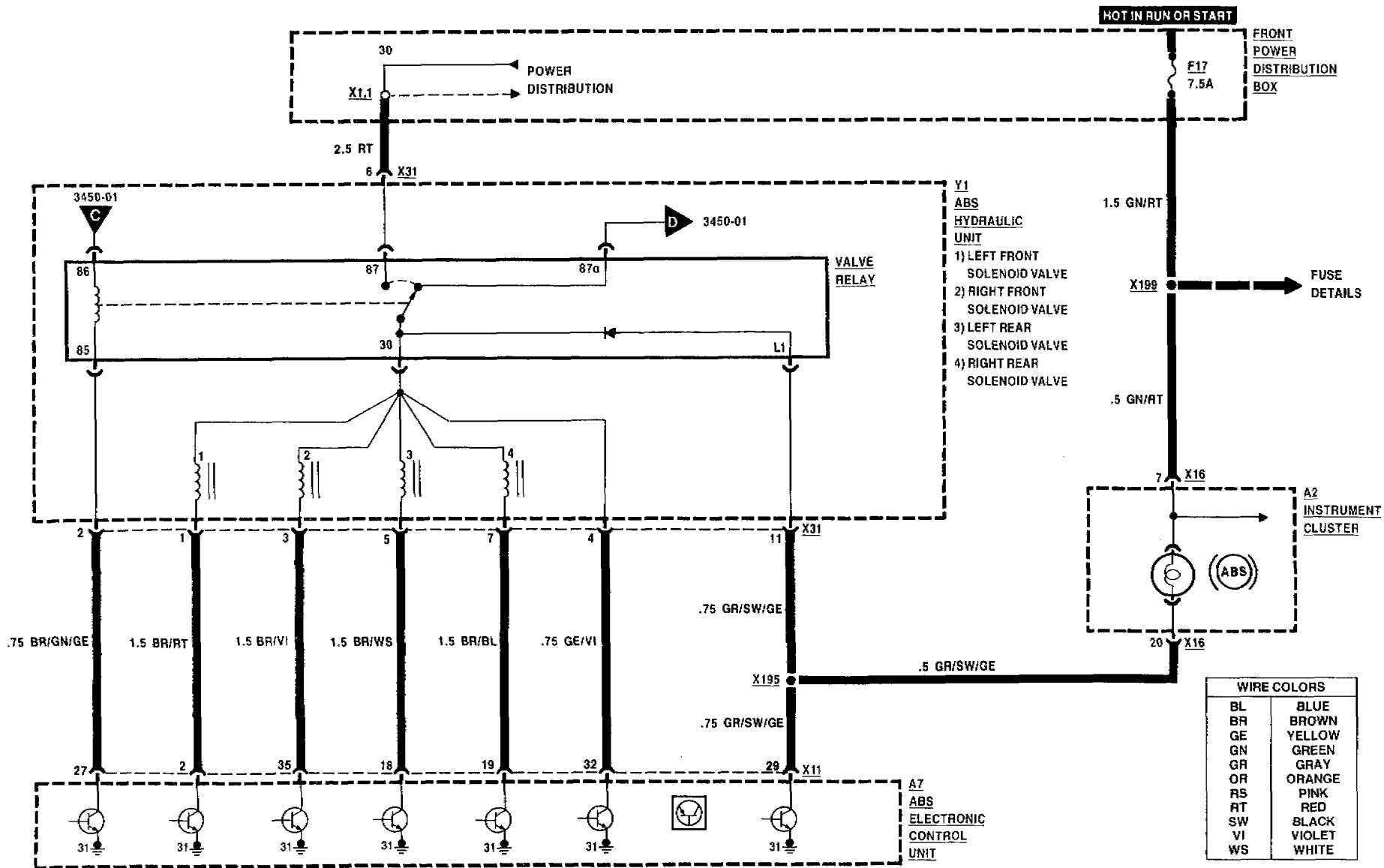



ANTILOCK BRAKE SYSTEM (ABS)

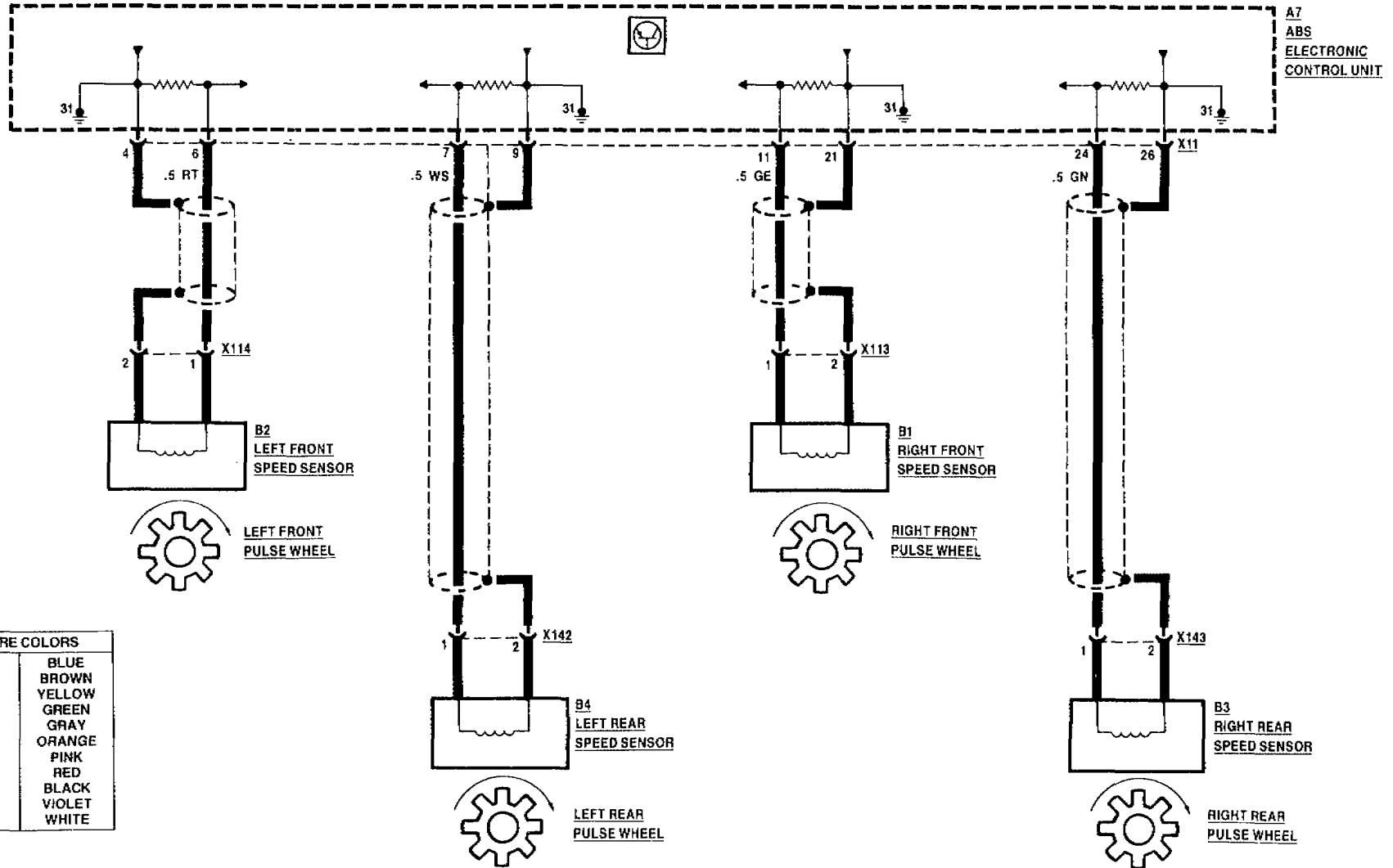

MEMORY MIRRORS

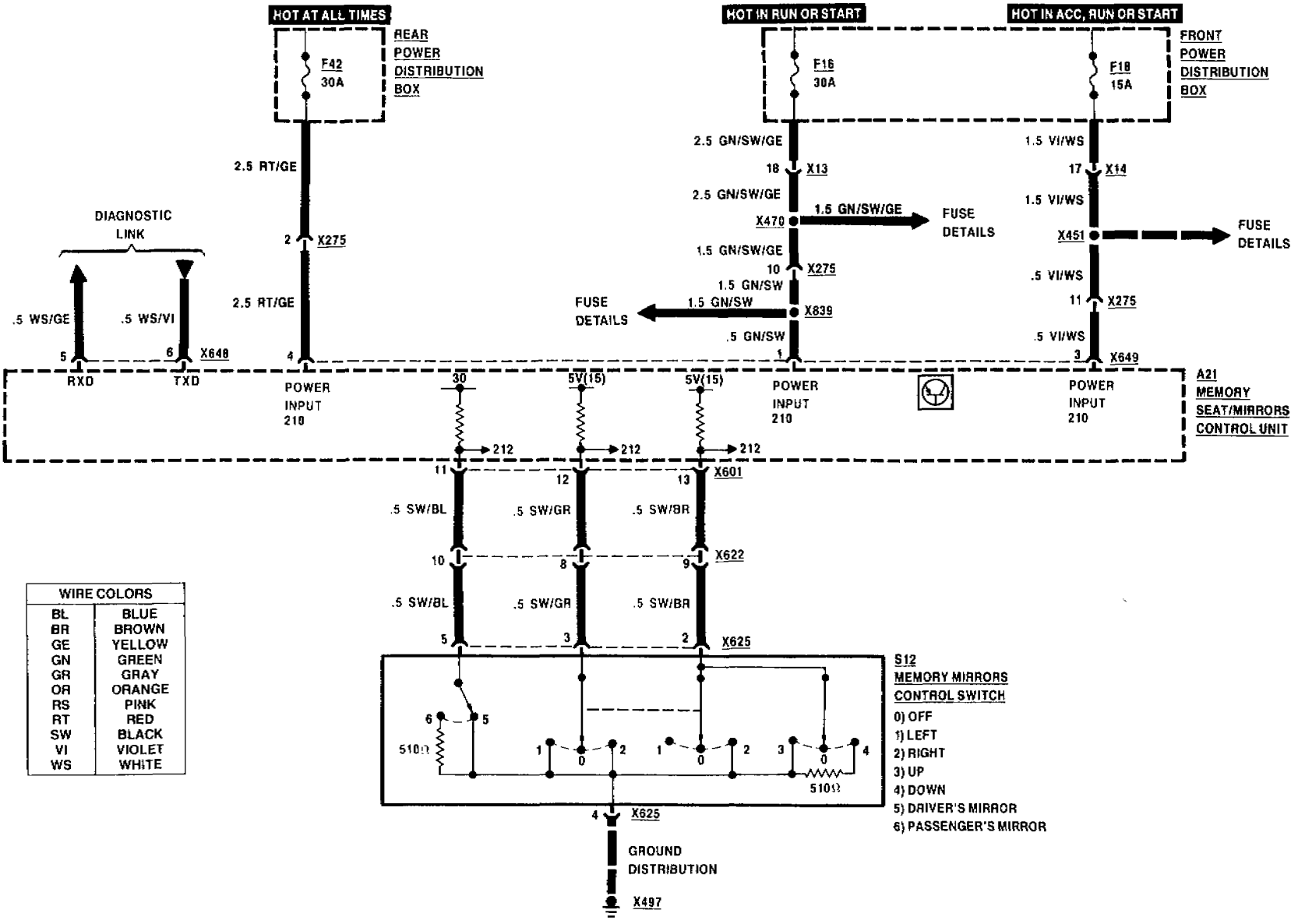

WIRE COLORS	
BL	BLUE
BR	BROWN
GE	YELLOW
GN	GREEN
GR	GRAY
OR	ORANGE
RS	PINK
RT	RED
SW	BLACK
VI	VIOLET
WS	WHITE

MEMORY MIRRORS

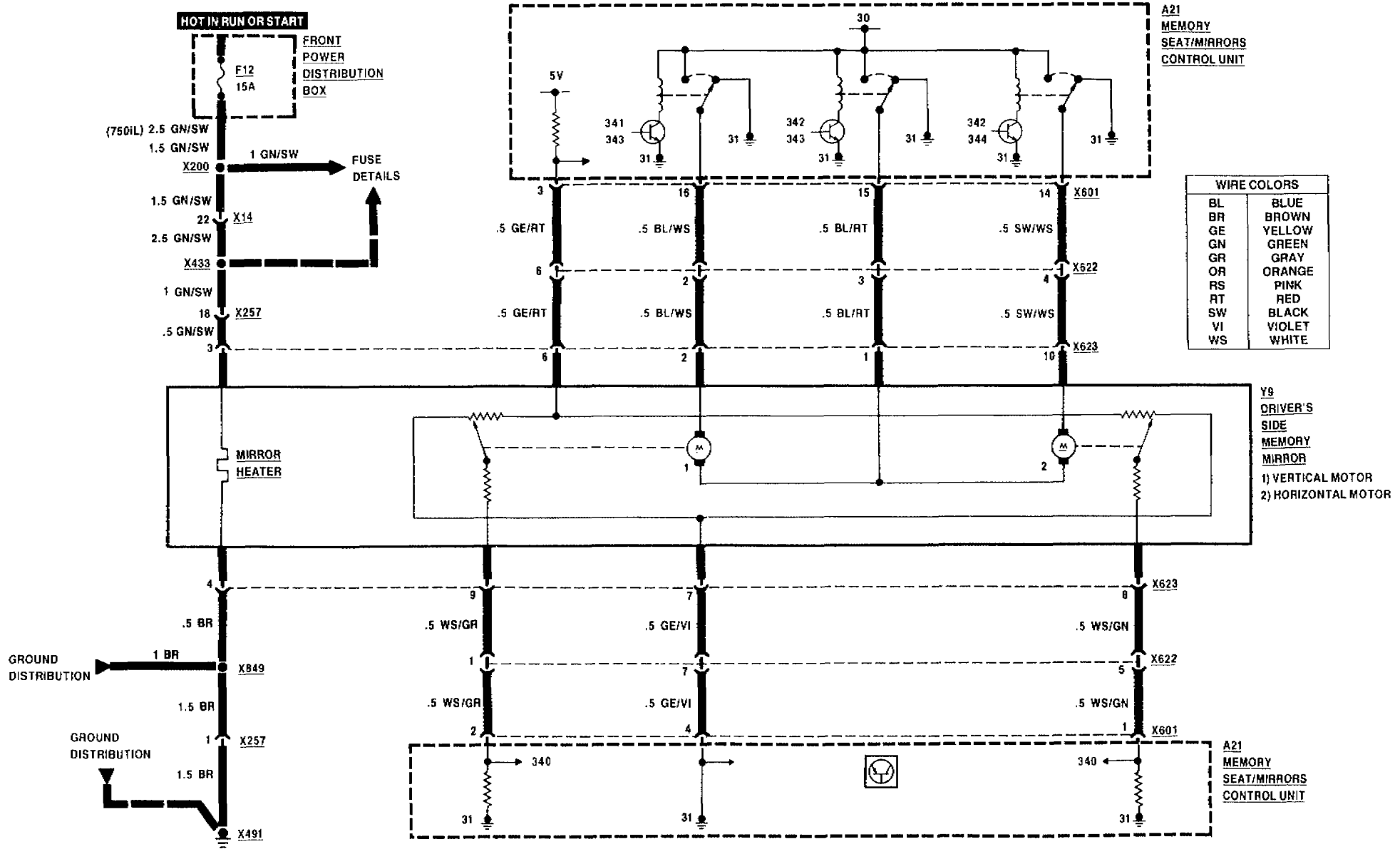



MEMORY MIRRORS

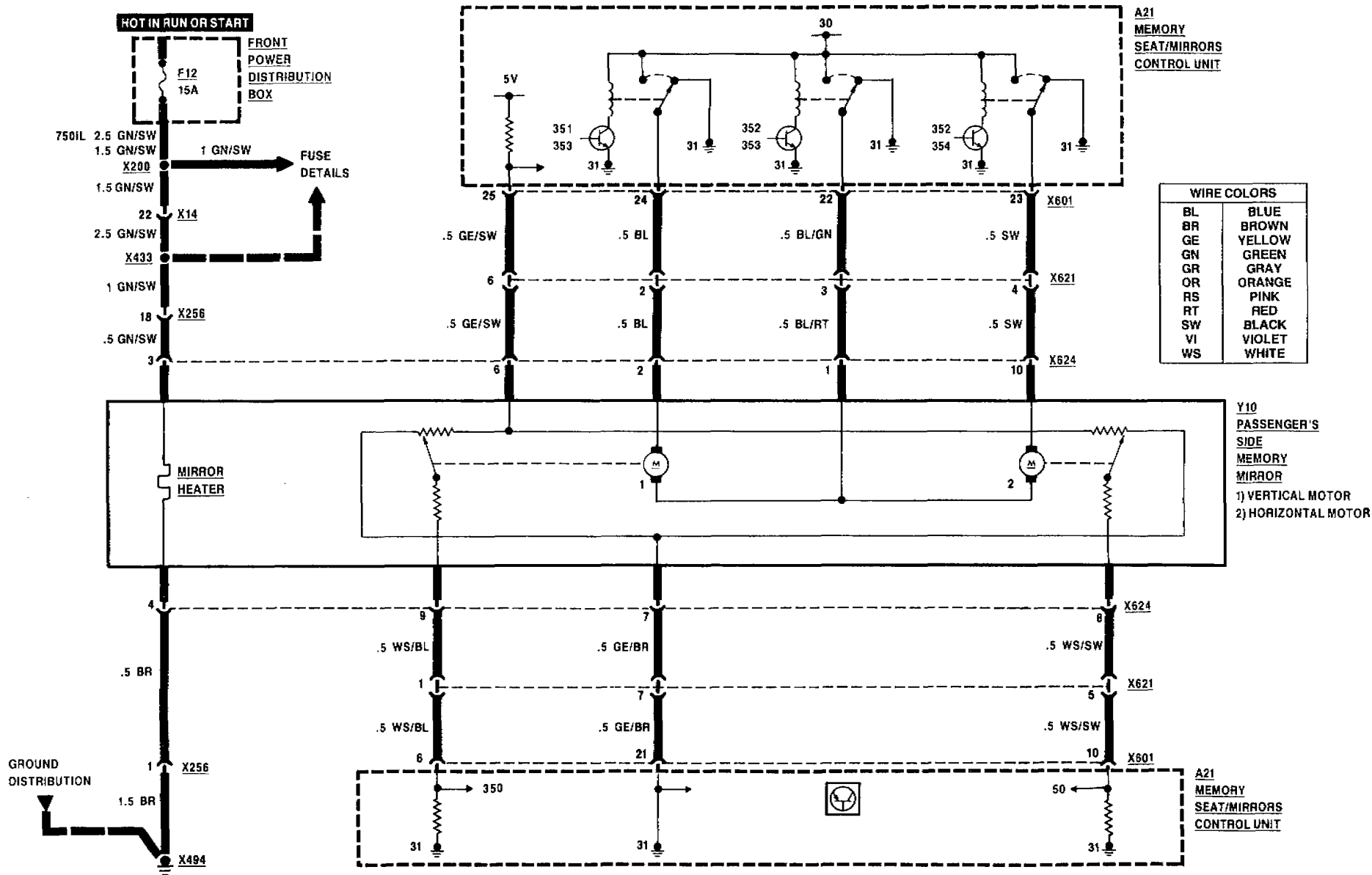



MEMORY MIRRORS

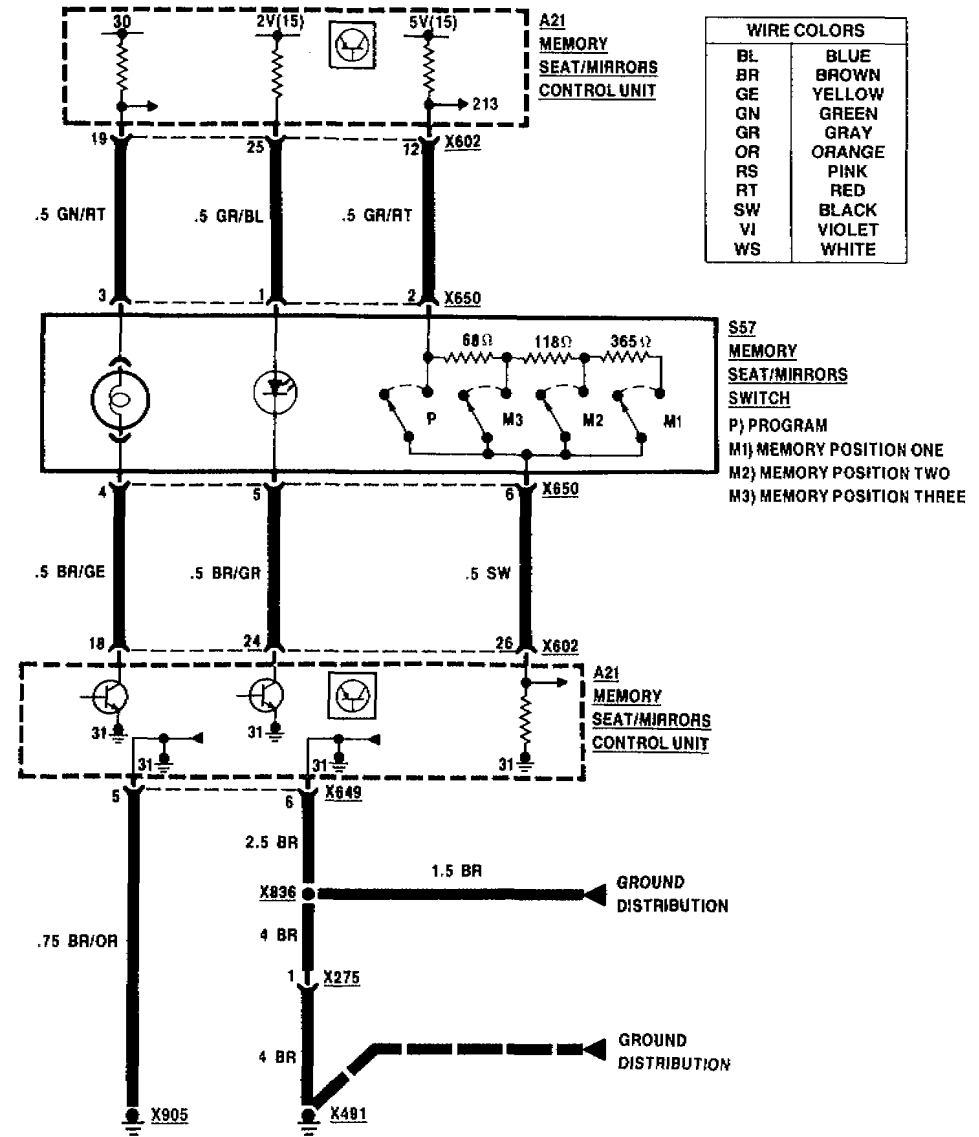
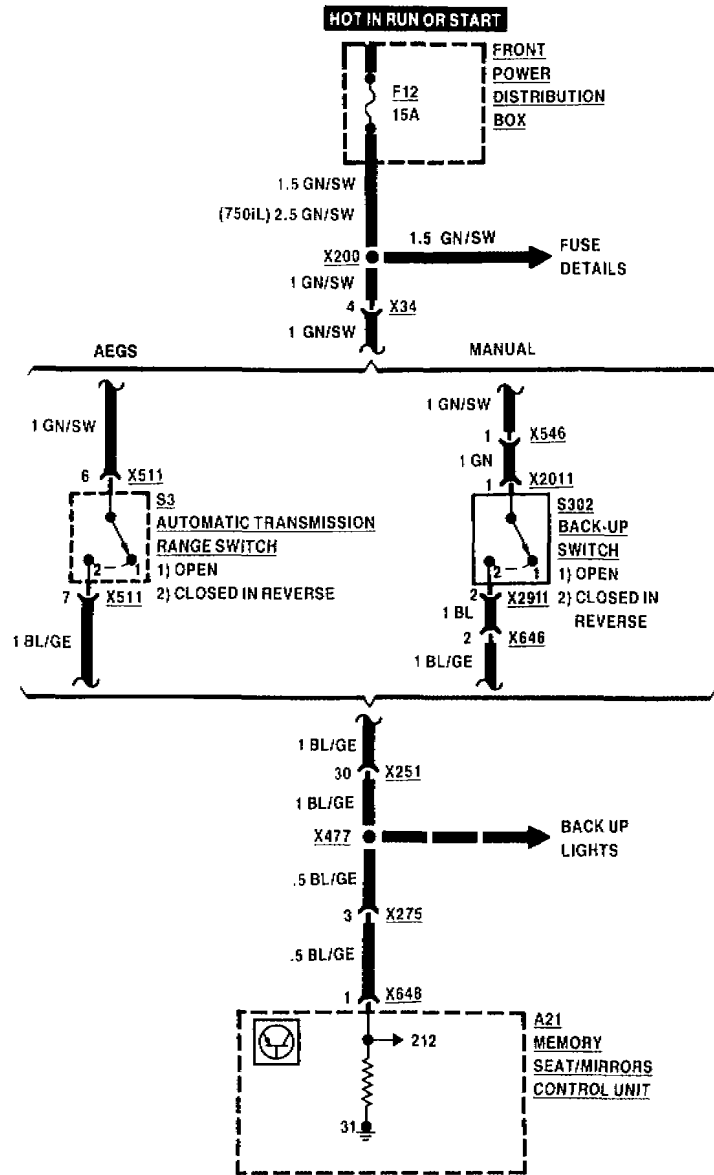

MEMORY MIRRORS

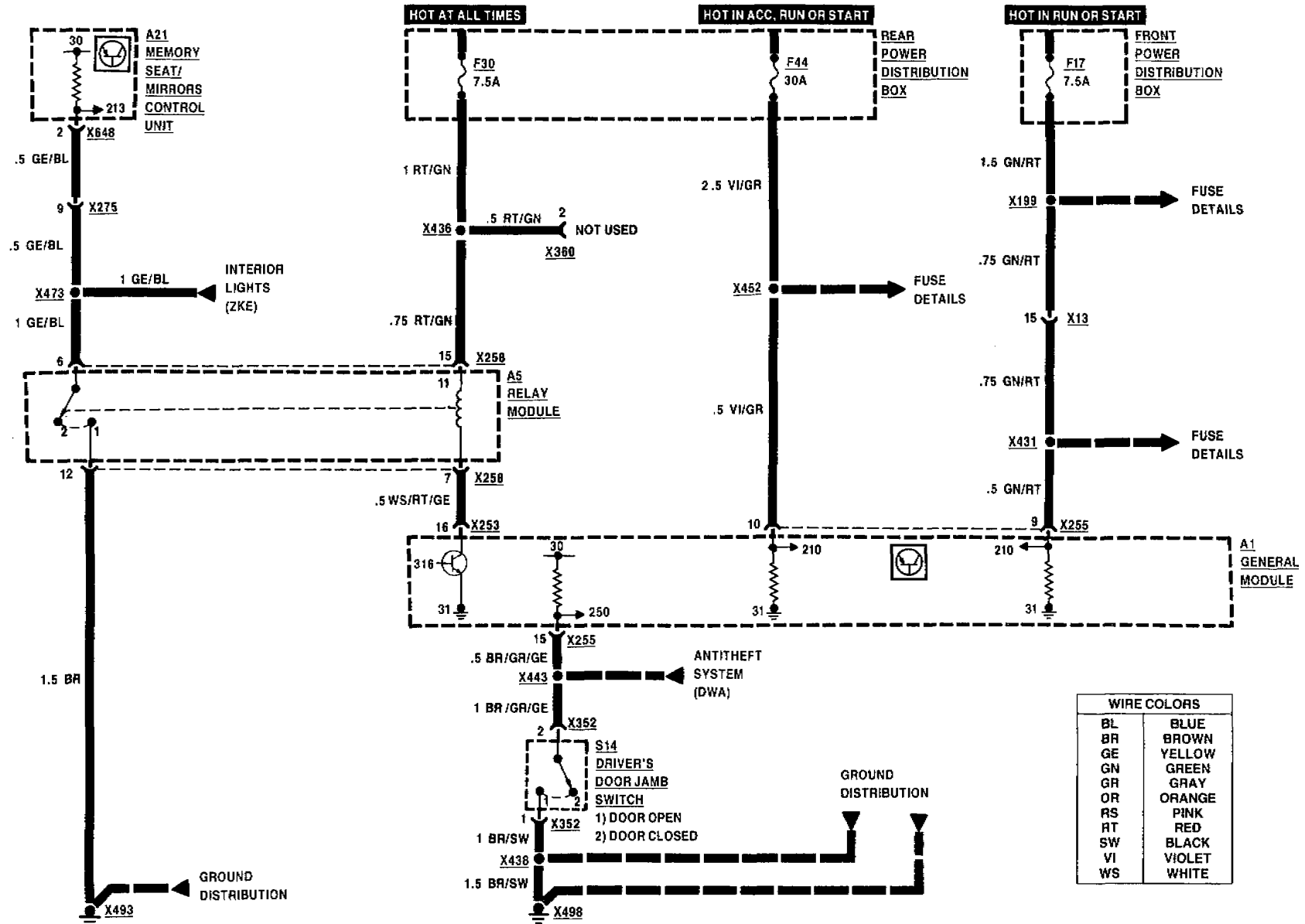

BMW 7 **DOOR LOCK HEATING (ZKE)**
INPUT DETAILS

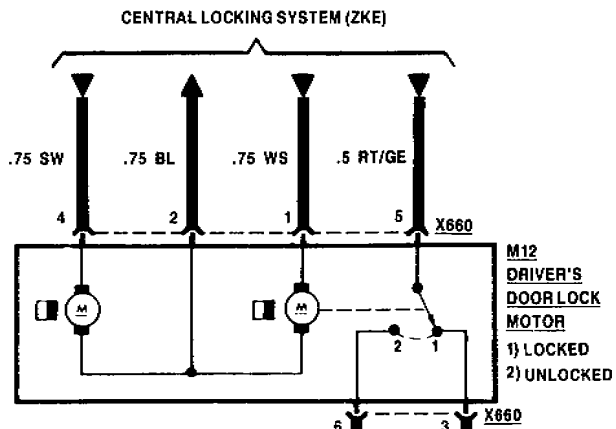

WIRE COLORS	
BL	BLUE
BR	BROWN
GE	YELLOW
GN	GREEN
GR	GRAY
OR	ORANGE
RS	PINK
RT	RED
SW	BLACK
VI	VIOLET
WS	WHITE

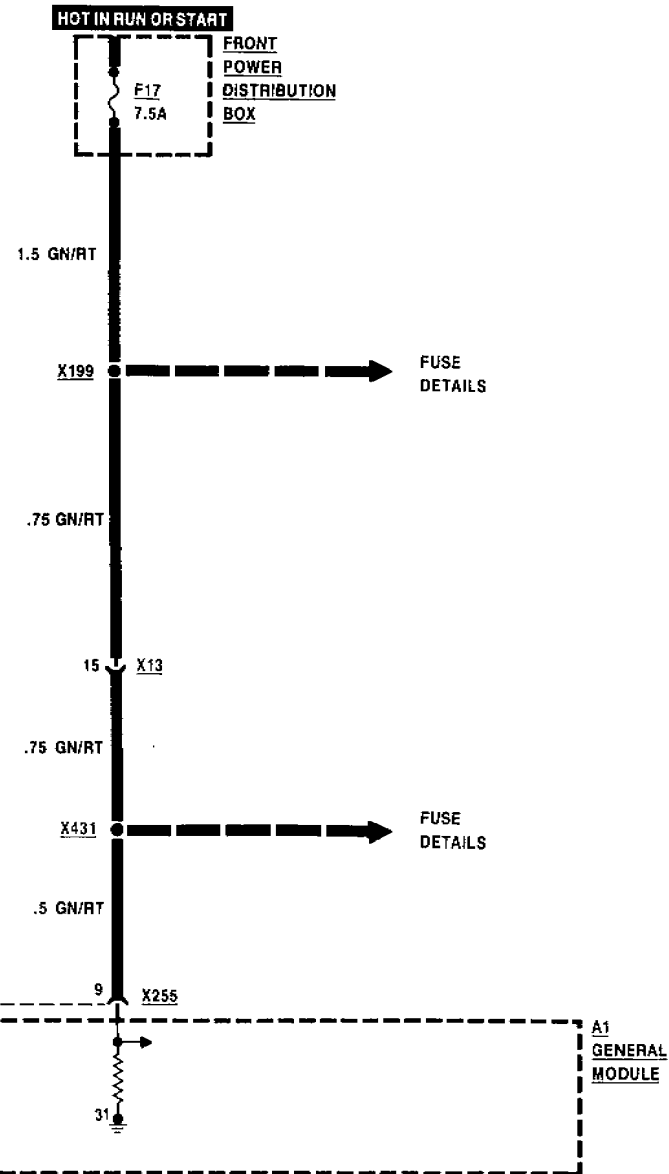
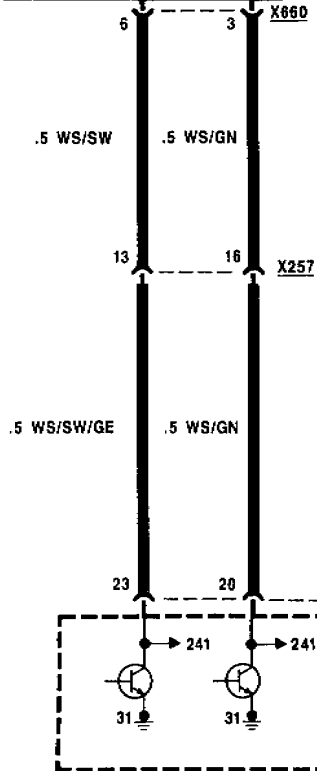



DOOR LOCK HEATING (ZKE) INPUT DETAILS

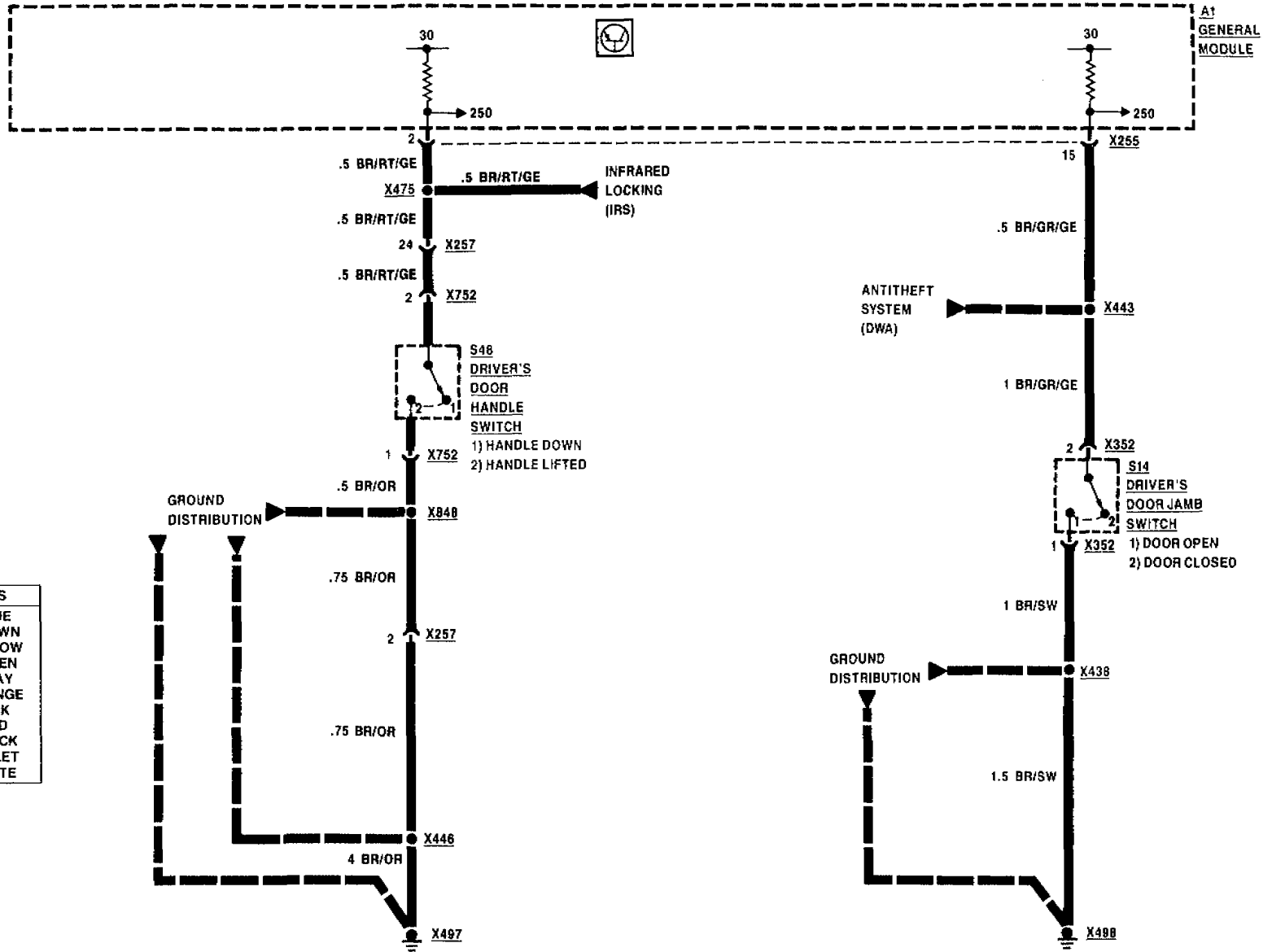

WIRE COLORS	
BL	BLUE
BR	BROWN
GE	YELLOW
GN	GREEN
GR	GRAY
OR	ORANGE
RS	PINK
RT	RED
SW	BLACK
VI	VIOLET
WS	WHITE



DOOR LOCK HEATING (ZKE) OUTPUT DETAILS

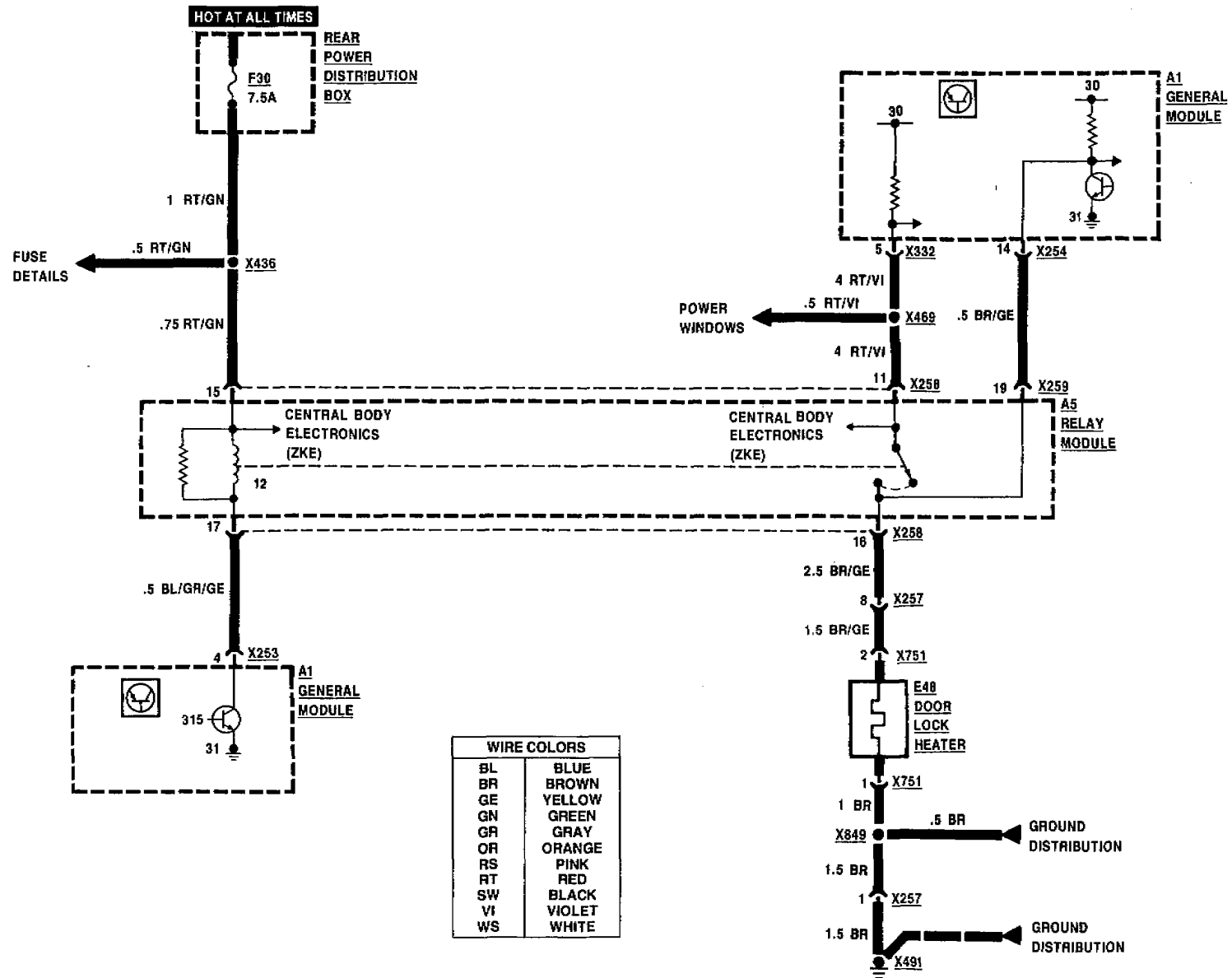



CENTRAL LOCKING SYSTEM (ZKE)

INPUT DETAILS

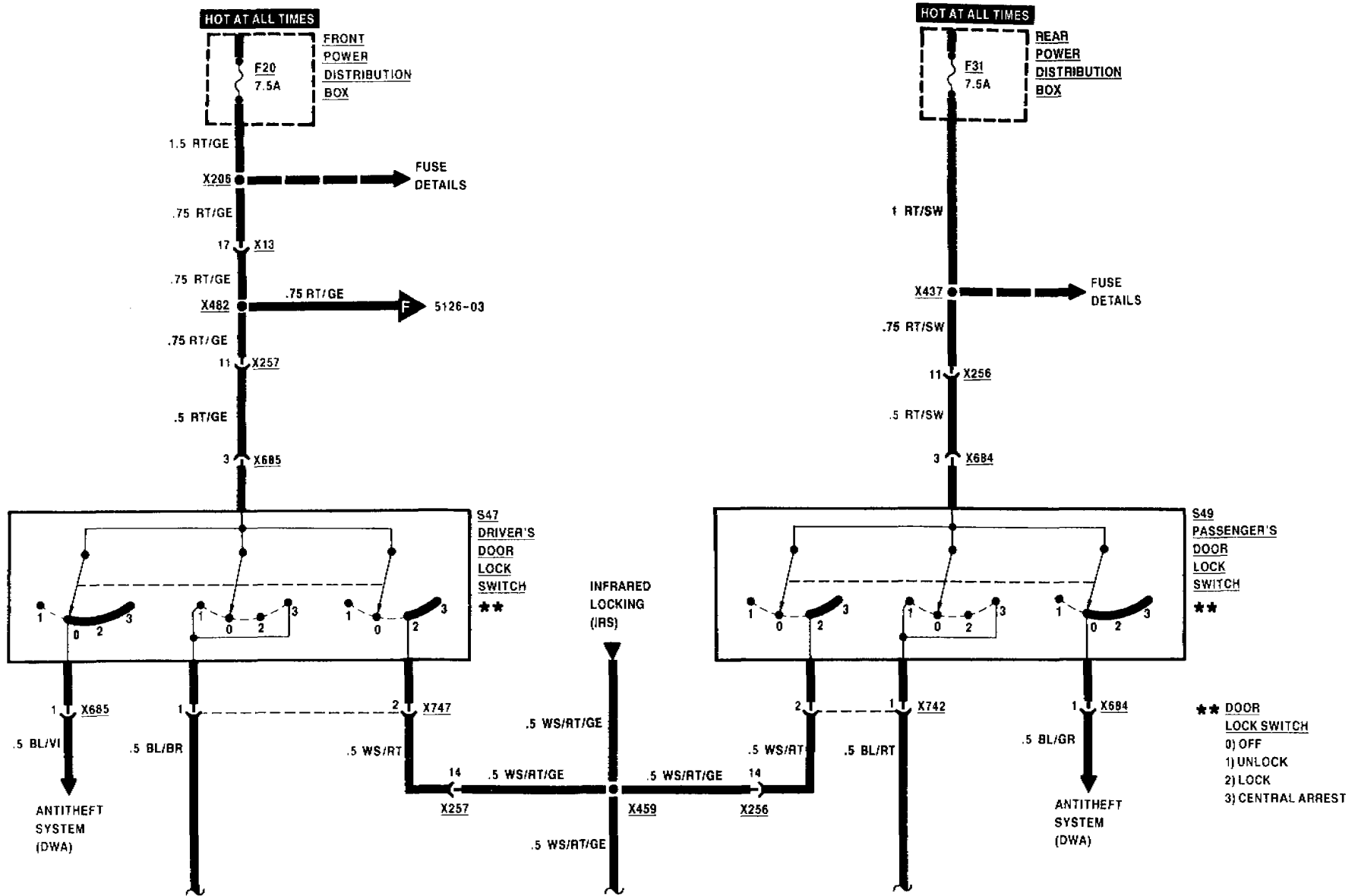

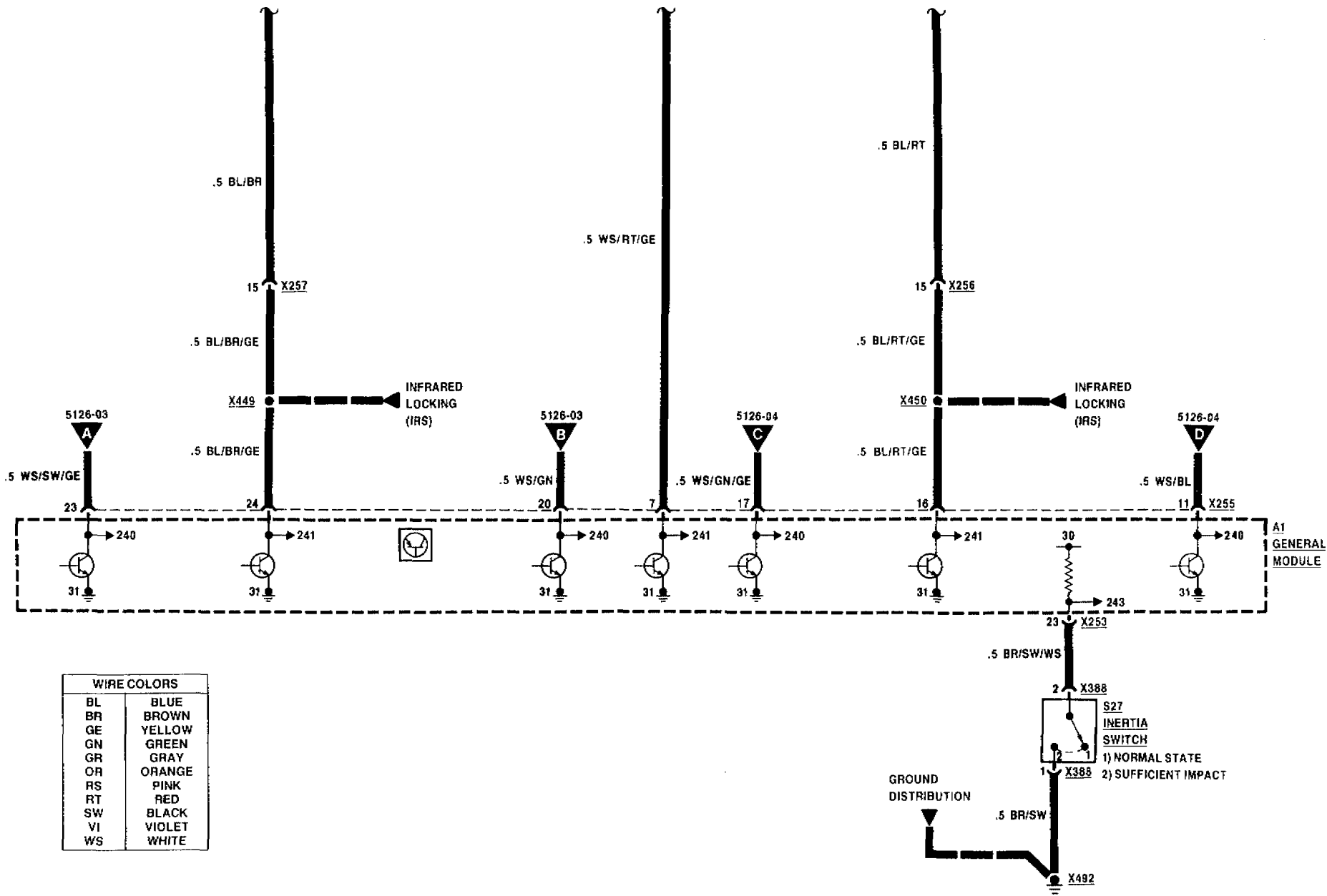



CENTRAL LOCKING SYSTEM (ZKE) OUTPUT DETAILS

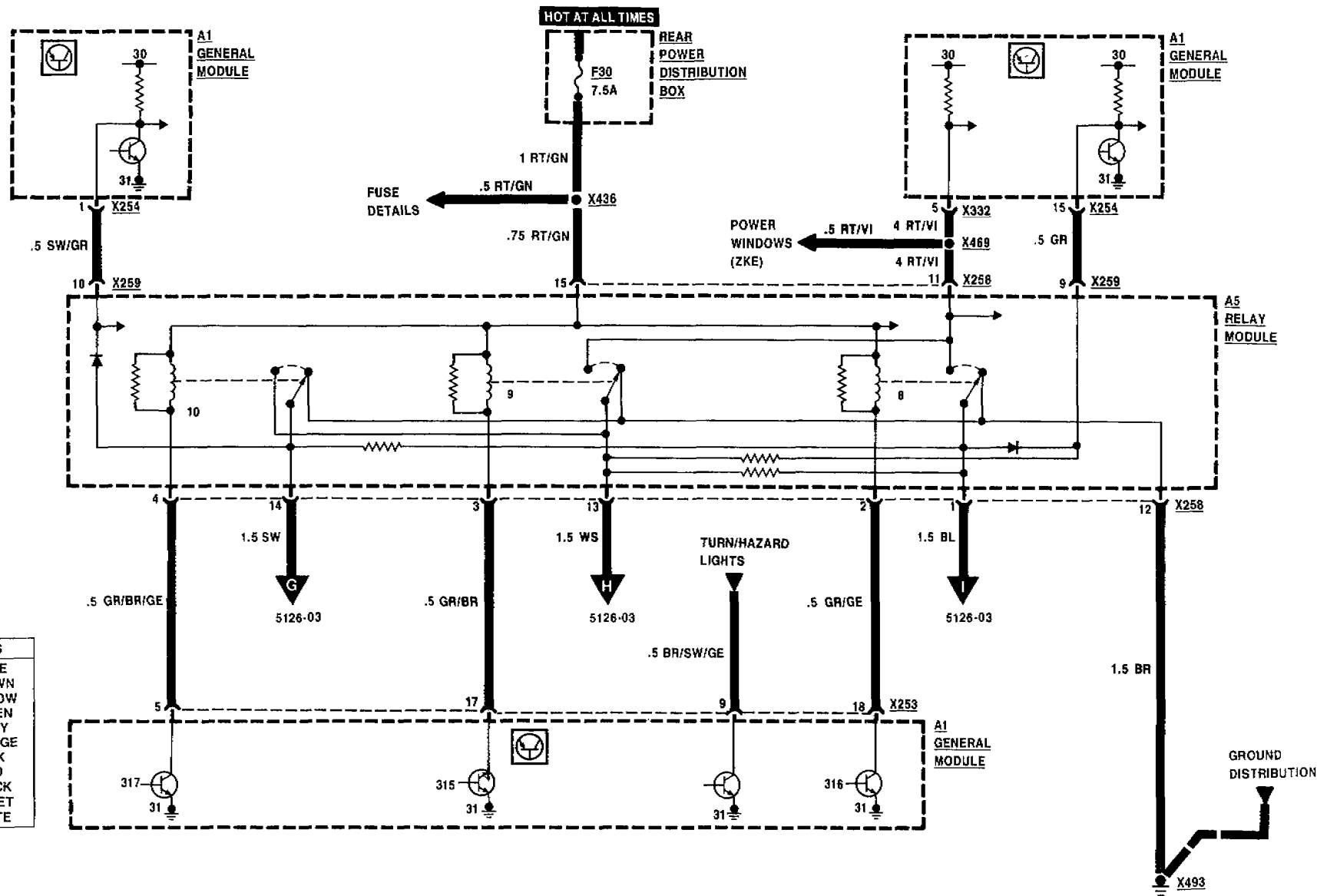

WIRE COLORS	
BL	BLUE
BR	BROWN
GE	YELLOW
GN	GREEN
GR	GRAY
OR	ORANGE
RS	PINK
RT	RED
SW	BLACK
VI	VIOLET
WS	WHITE



CENTRAL LOCKING SYSTEM (ZKE)

OUTPUT DETAILS

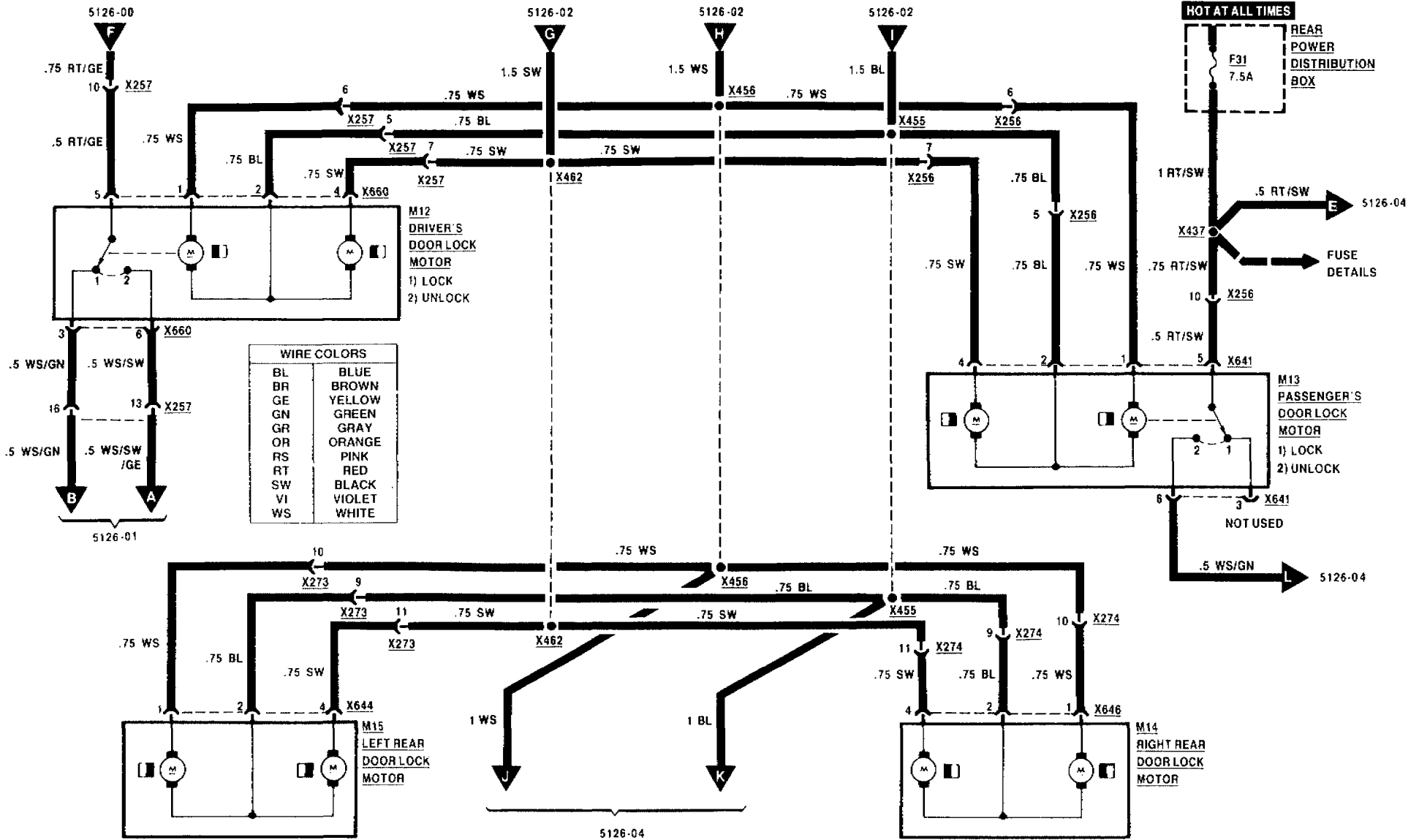



CENTRAL LOCKING SYSTEM (ZKE)

OUTPUT DETAILS

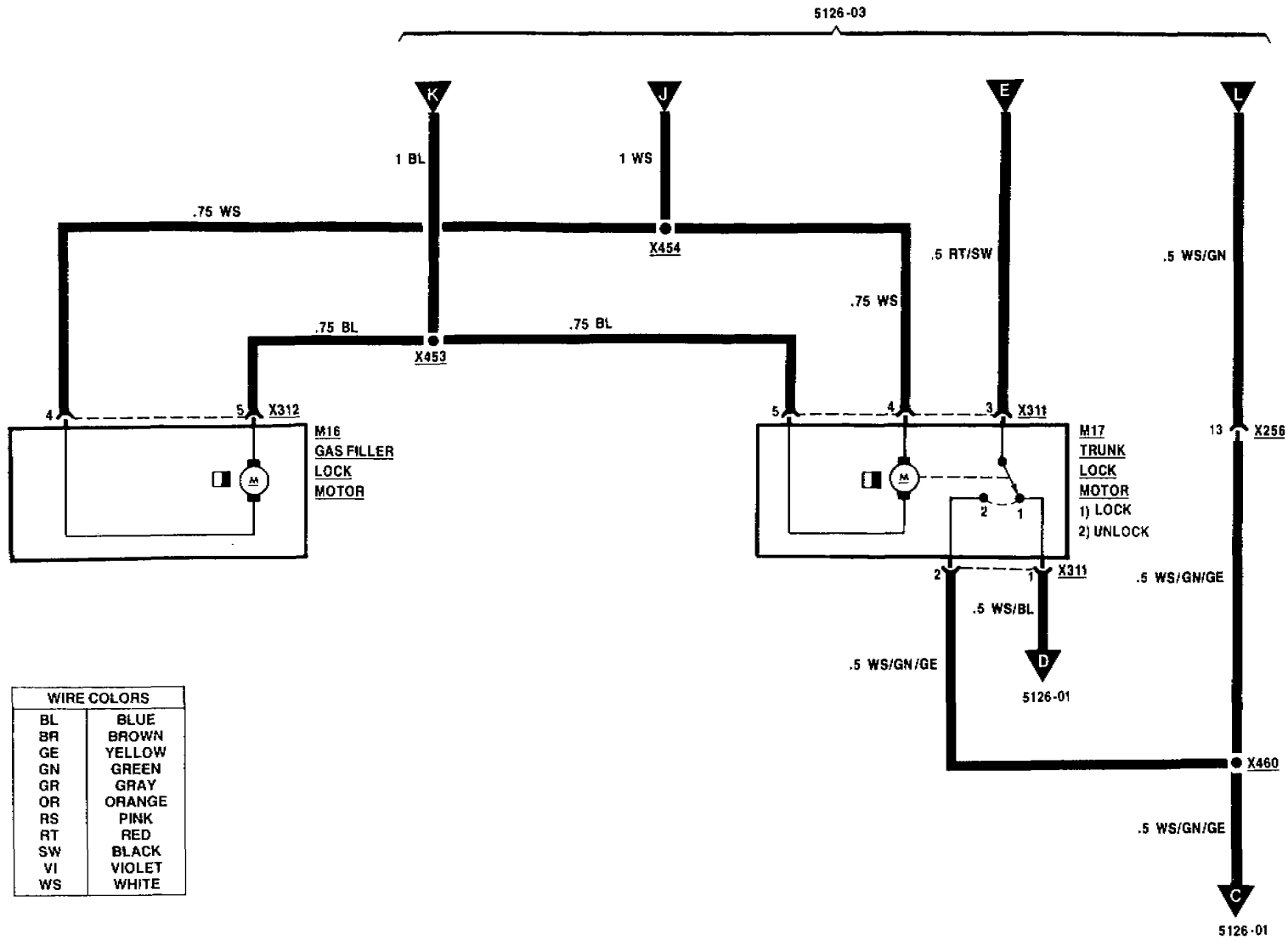

WIRE COLORS	
BL	BLUE
BR	BROWN
GE	YELLOW
GN	GREEN
GR	GRAY
OR	ORANGE
RS	PINK
RT	RED
SW	BLACK
VI	VIOLET
WS	WHITE



CENTRAL LOCKING SYSTEM (ZKE)

OUTPUT DETAILS

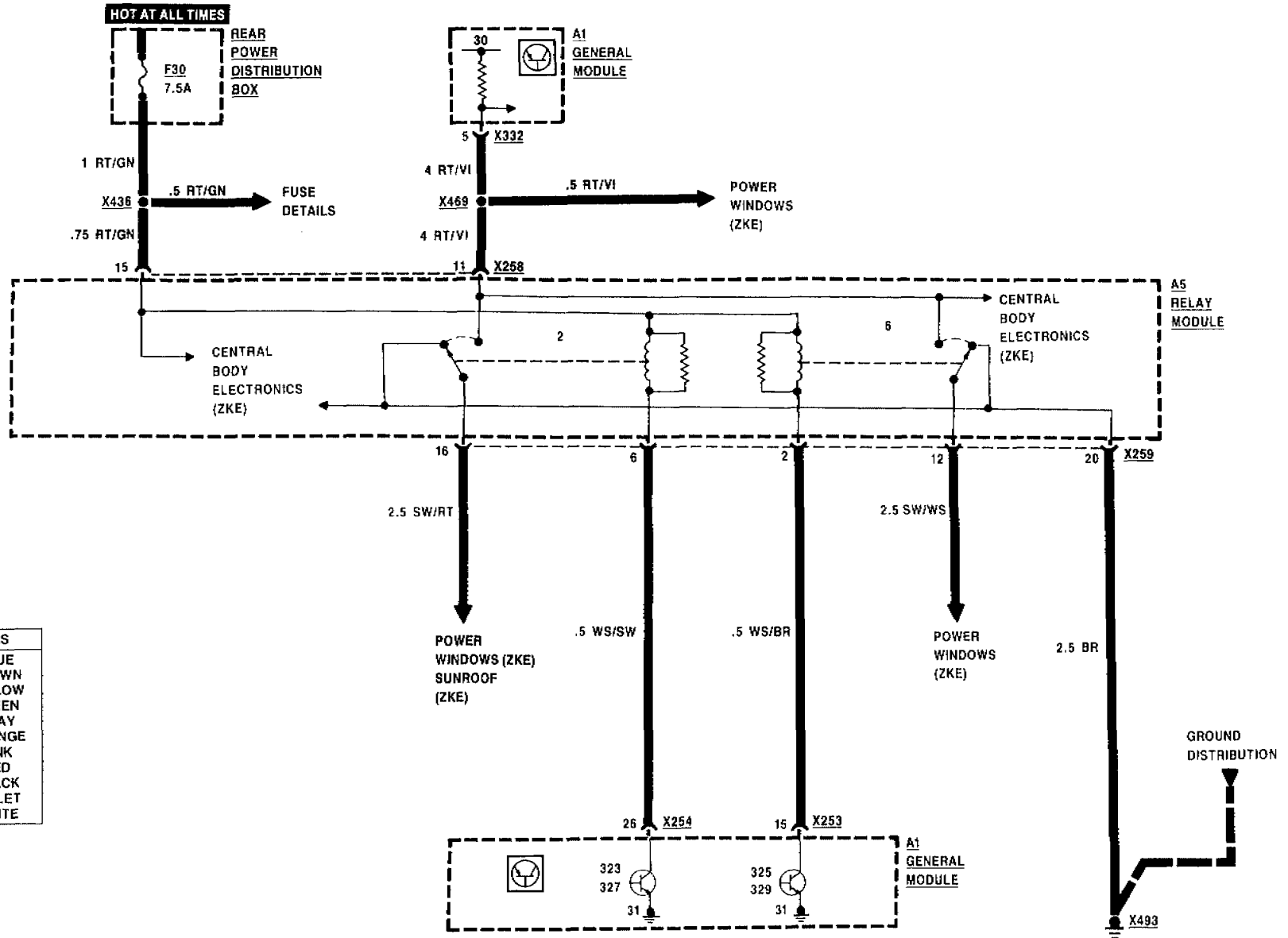



POWER WINDOWS (ZKE)

INPUT DETAILS

WIRE COLORS	
BL	BLUE
BR	BROWN
GE	YELLOW
GN	GREEN
GR	GRAY
OR	ORANGE
RS	PINK
RT	RED
SW	BLACK
VI	VIOLET
WS	WHITE

HOT IN ACC. RUN OR START

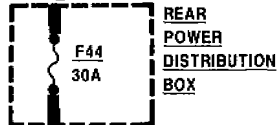

HOT IN RUN OR START

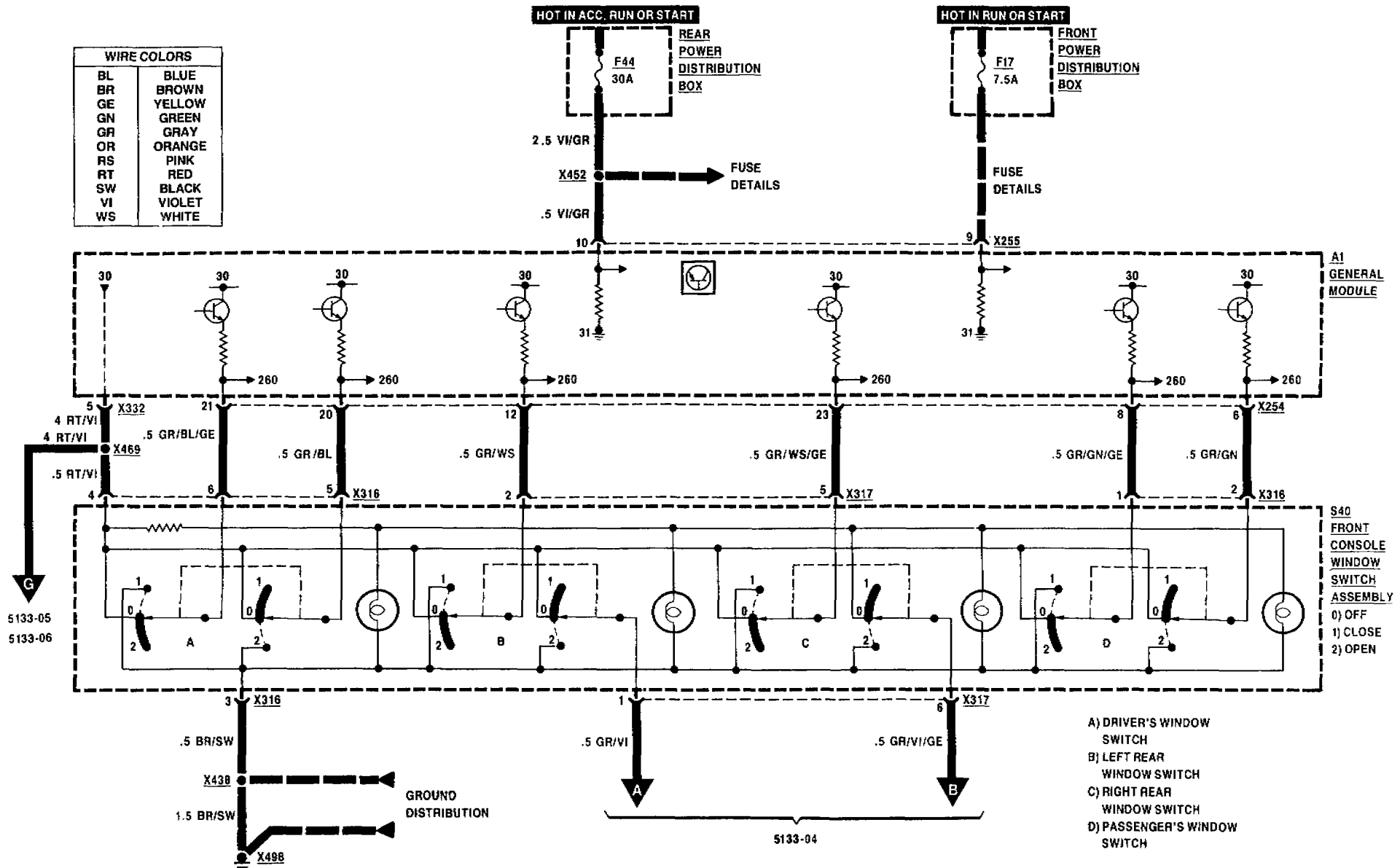
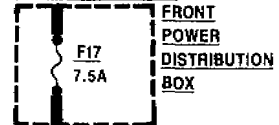

- A) DRIVER'S WINDOW SWITCH
- B) LEFT REAR WINDOW SWITCH
- C) RIGHT REAR WINDOW SWITCH
- D) PASSENGER'S WINDOW SWITCH

A1 GENERAL MODULE

S40 FRONT CONSOLE WINDOW SWITCH ASSEMBLY

- 0) OFF
- 1) CLOSE
- 2) OPEN



POWER WINDOWS (ZKE)

INPUT DETAILS

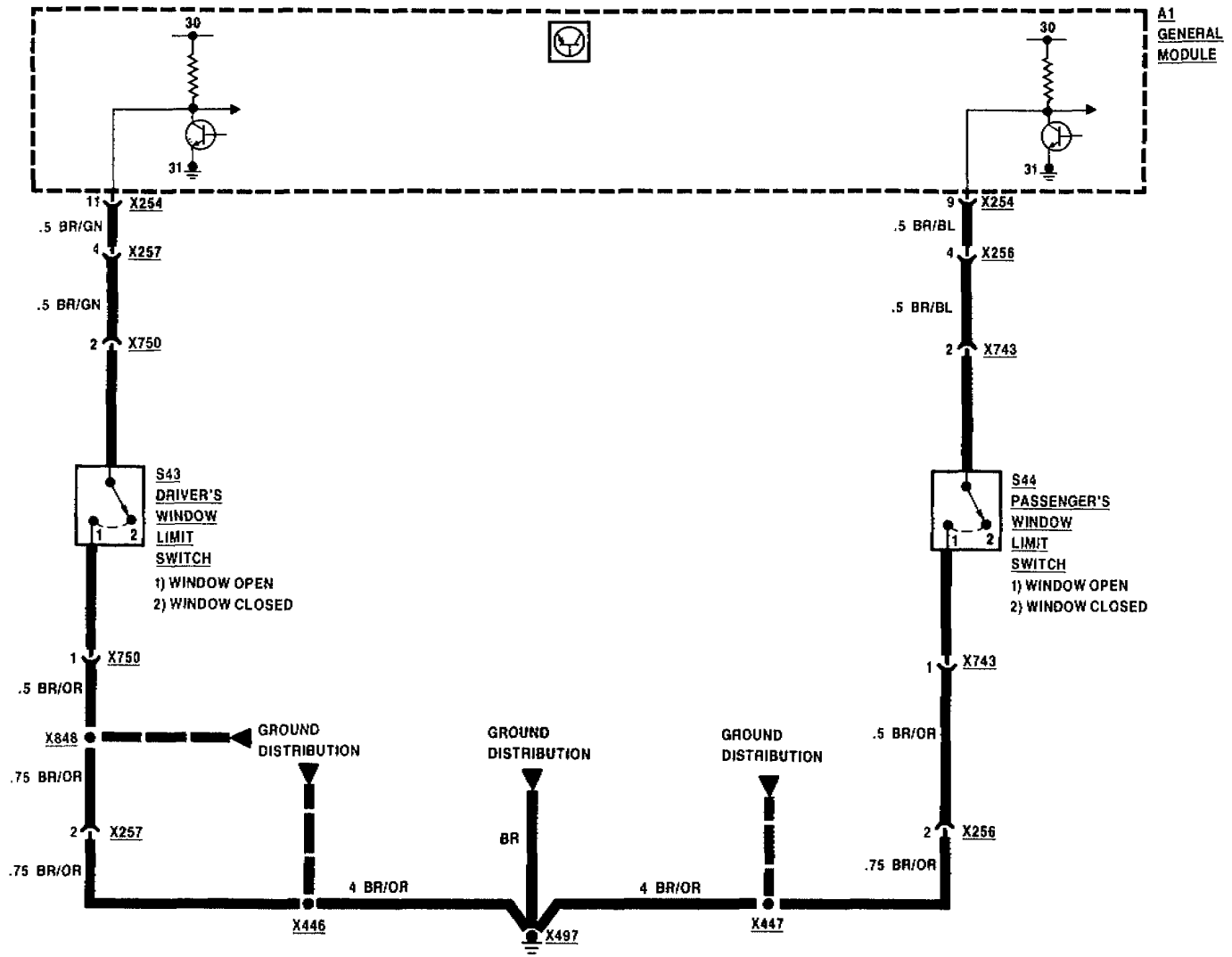

WIRE COLORS	
BL	BLUE
BR	BROWN
GE	YELLOW
GN	GREEN
GR	GRAY
OR	ORANGE
RS	PINK
RT	RED
SW	BLACK
VI	VIOLET
WS	WHITE

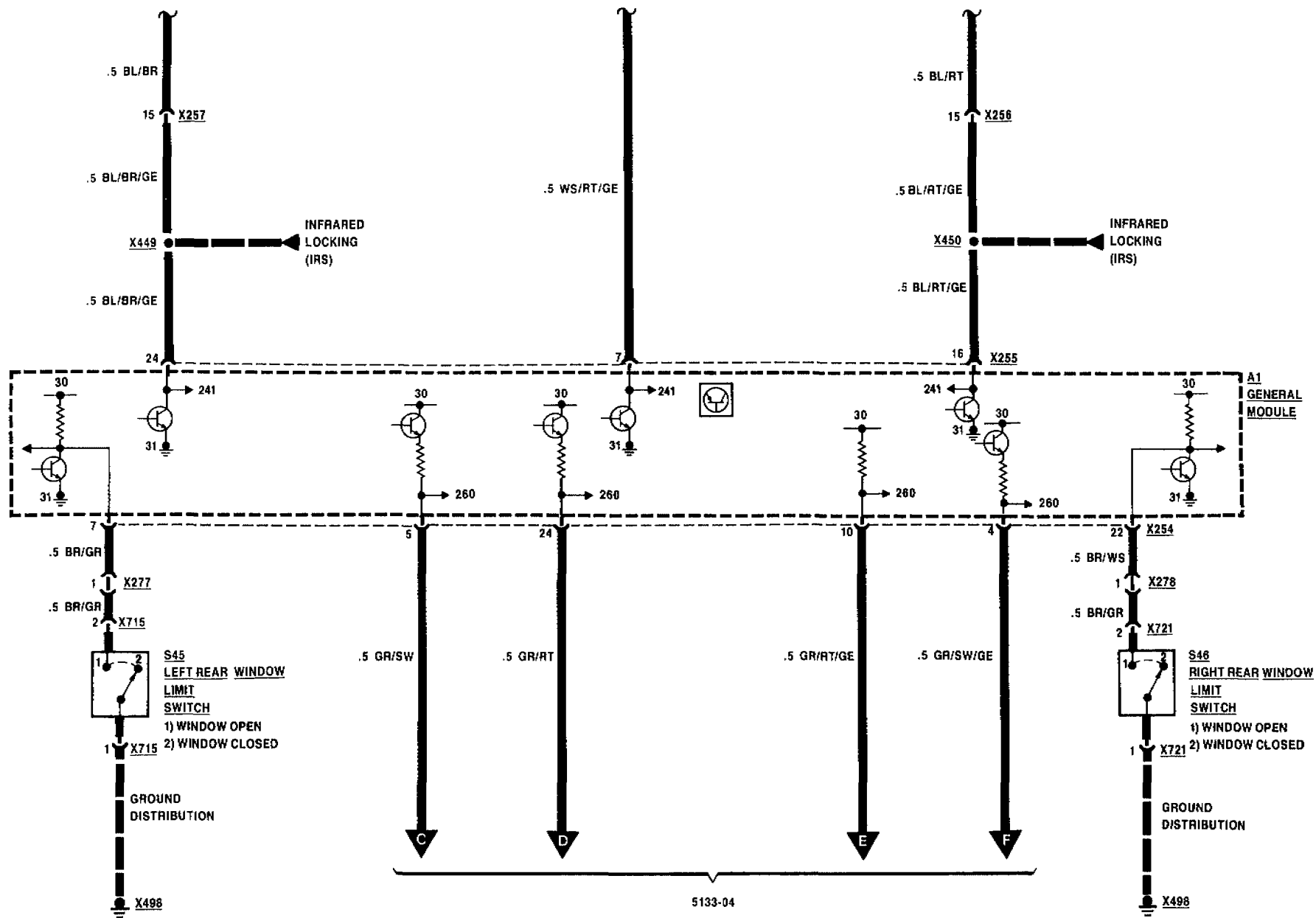

5133-04



POWER WINDOWS (ZKE)

INPUT DETAILS

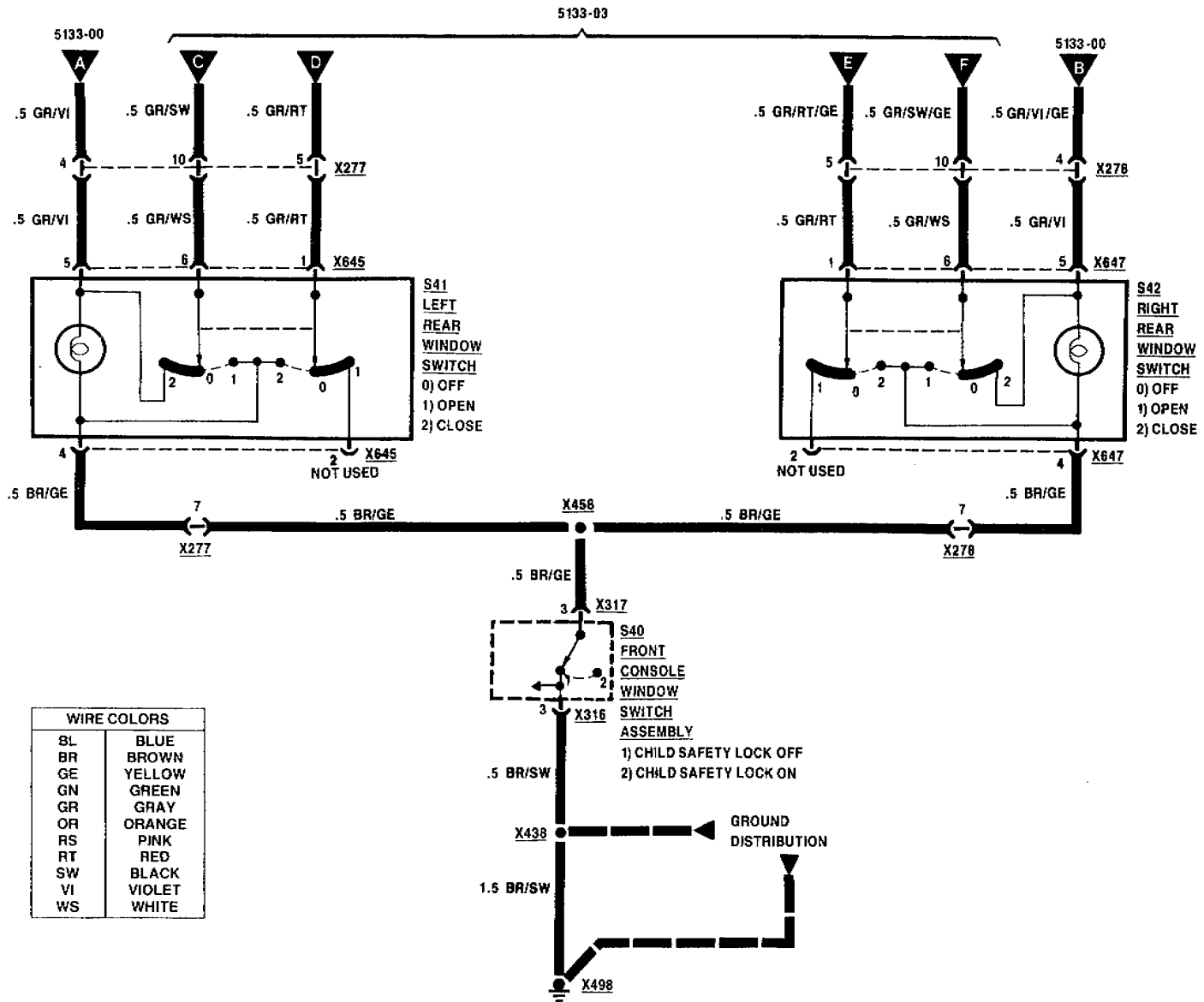



POWER WINDOWS (ZKE)

LEFT SIDE OUTPUT DETAILS

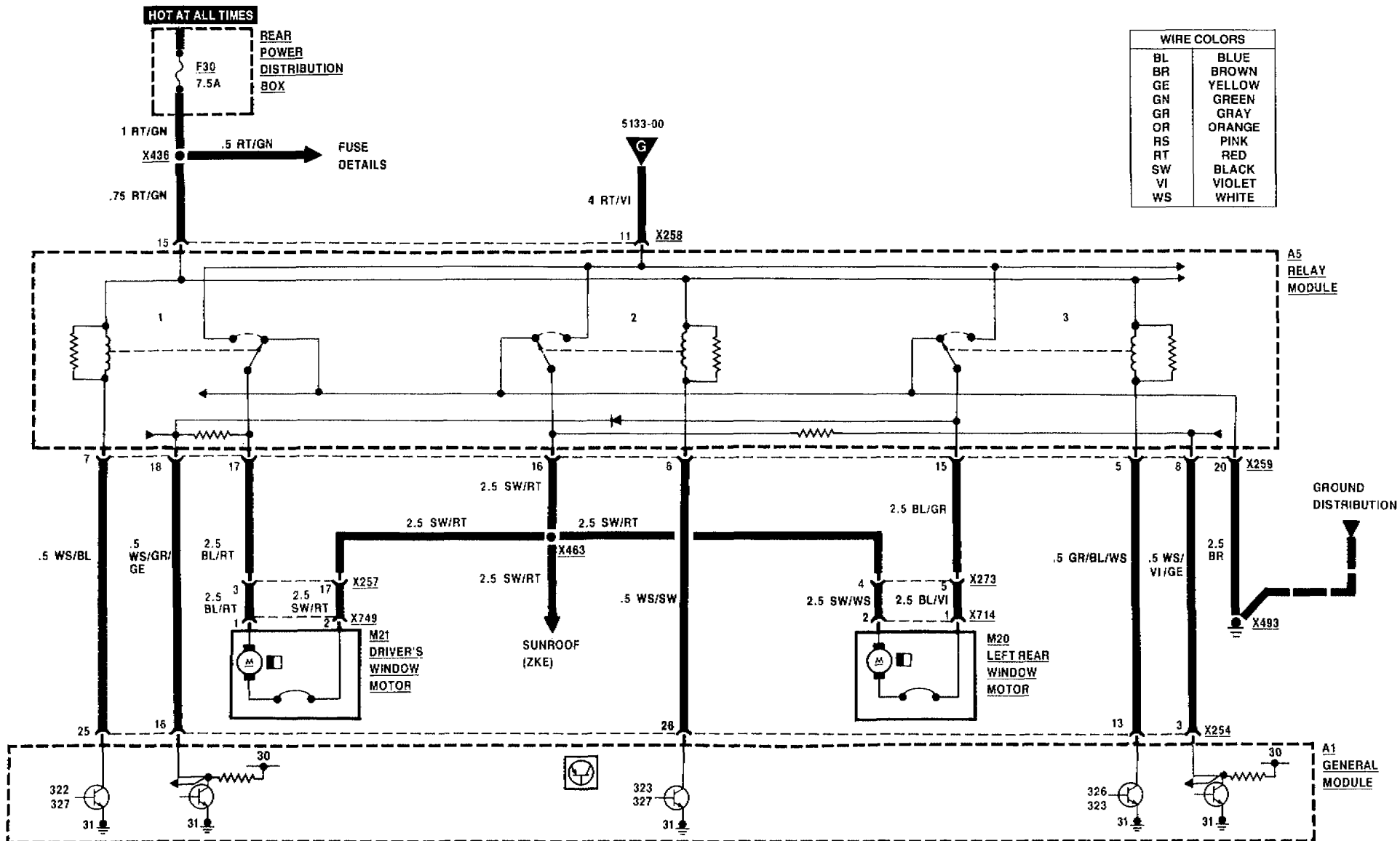

11/89

5133-05

1989



POWER WINDOWS (ZKE) RIGHT SIDE OUTPUT DETAILS

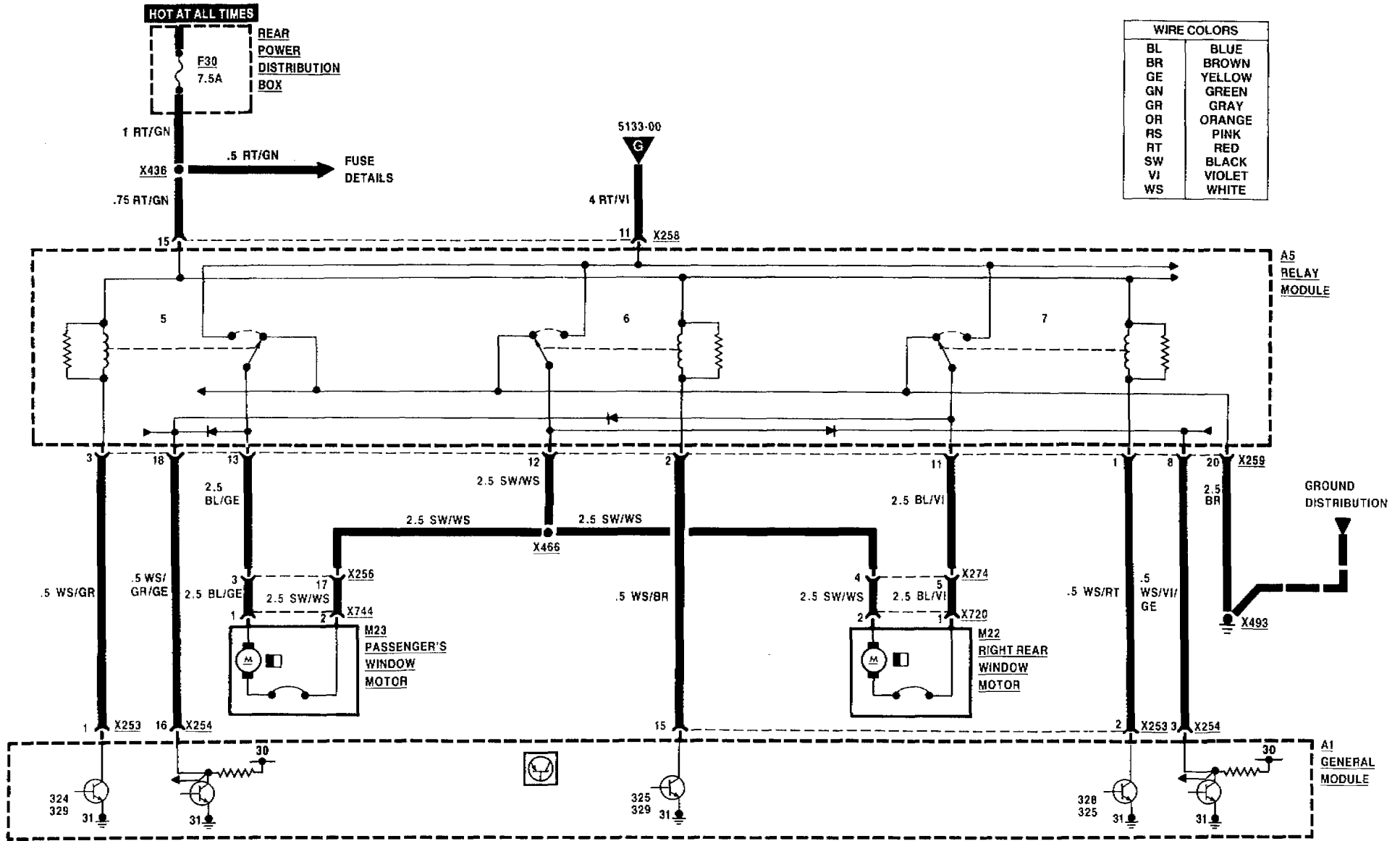



POWER SEATS

PASSENGER'S SEAT

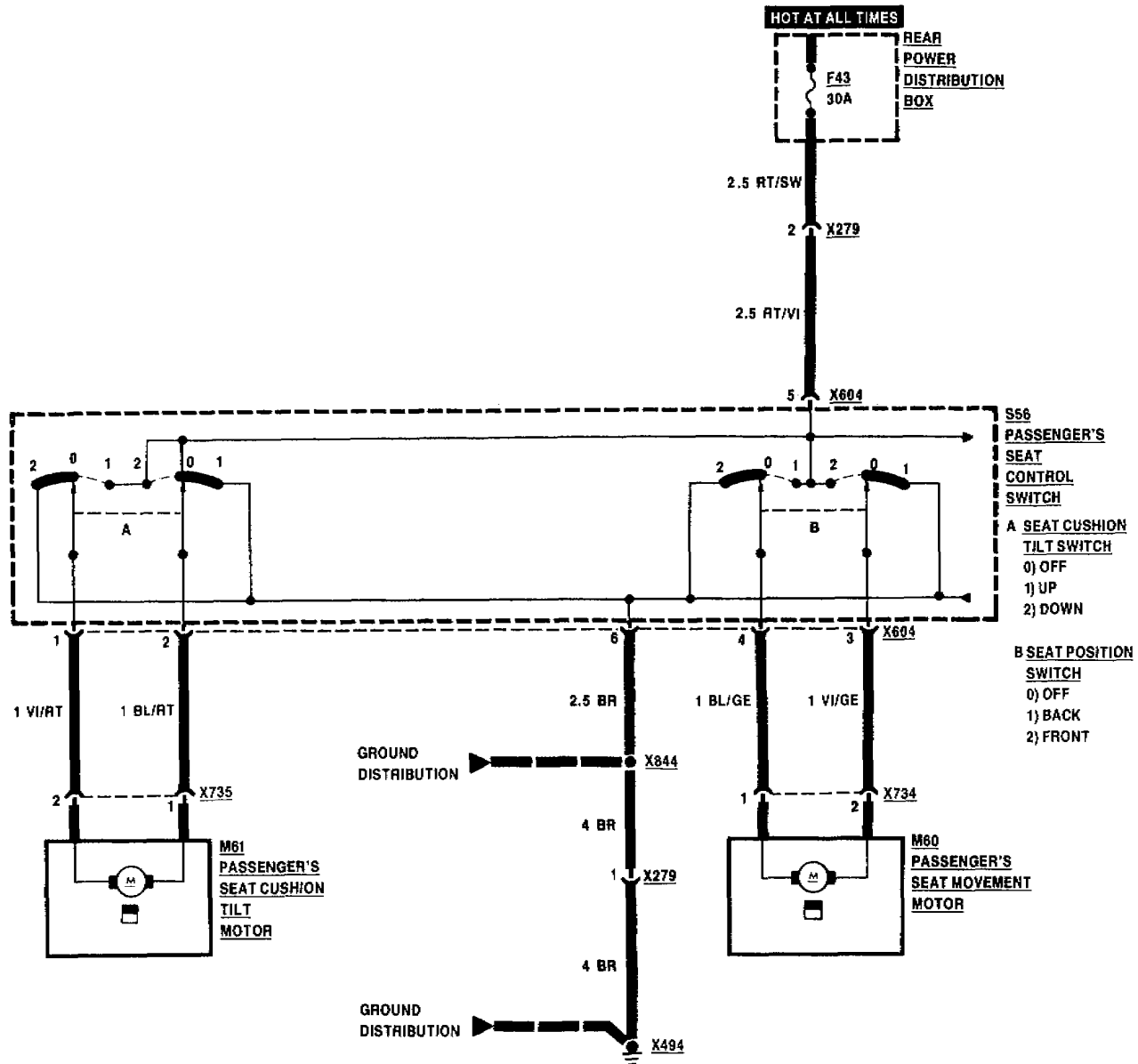

WIRE COLORS	
BL	BLUE
BR	BROWN
GE	YELLOW
GN	GREEN
GR	GRAY
OR	ORANGE
RS	PINK
RT	RED
SW	BLACK
VI	VIOLET
WS	WHITE

BMW 7 **POWER SEATS**
PASSENGER'S SEAT

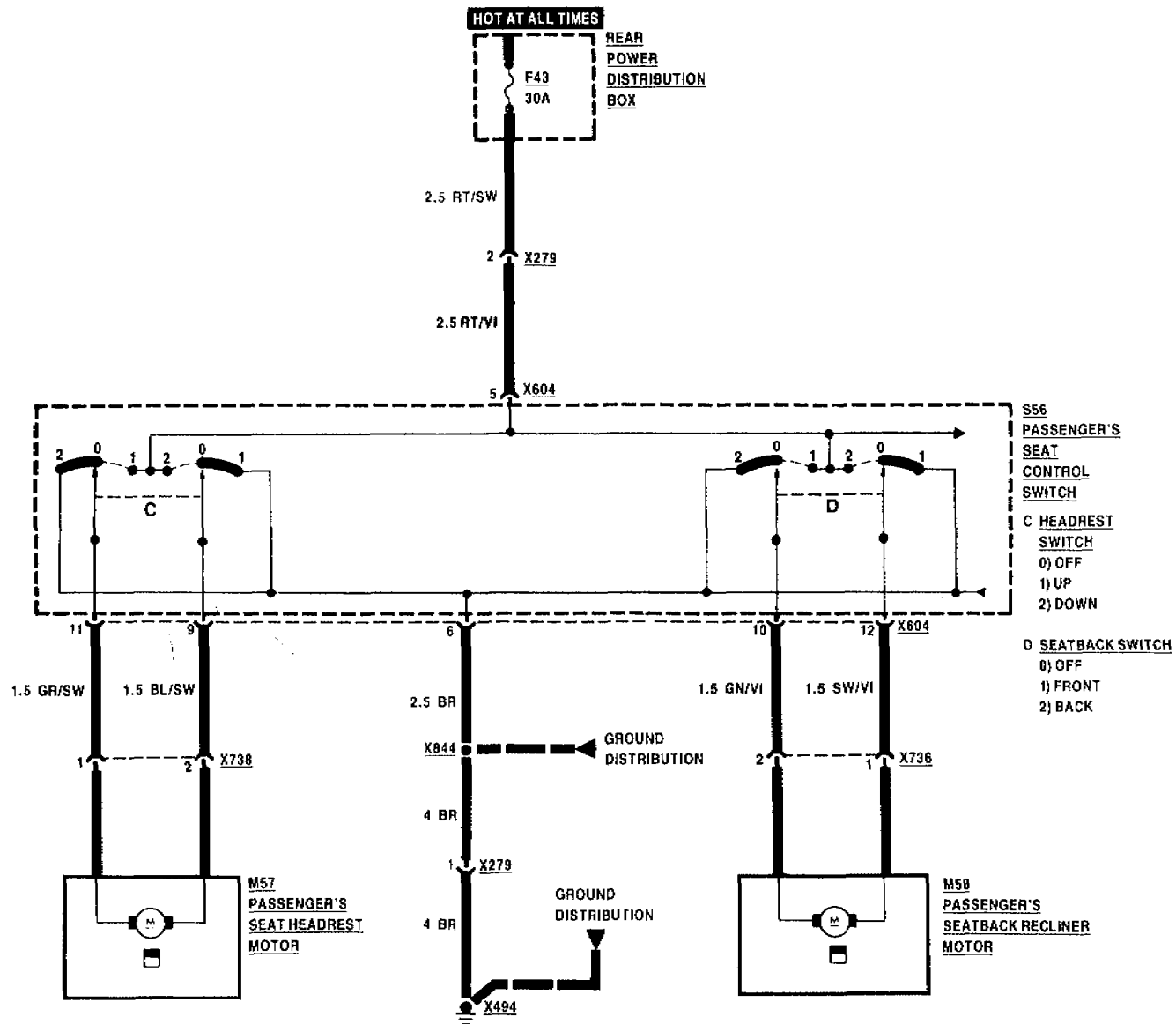

WIRE COLORS	
BL	BLUE
BR	BROWN
GE	YELLOW
GN	GREEN
GR	GRAY
OR	ORANGE
RS	PINK
RT	RED
SW	BLACK
VI	VIOLET
WS	WHITE



POWER SEATS

PASSENGER'S SEAT

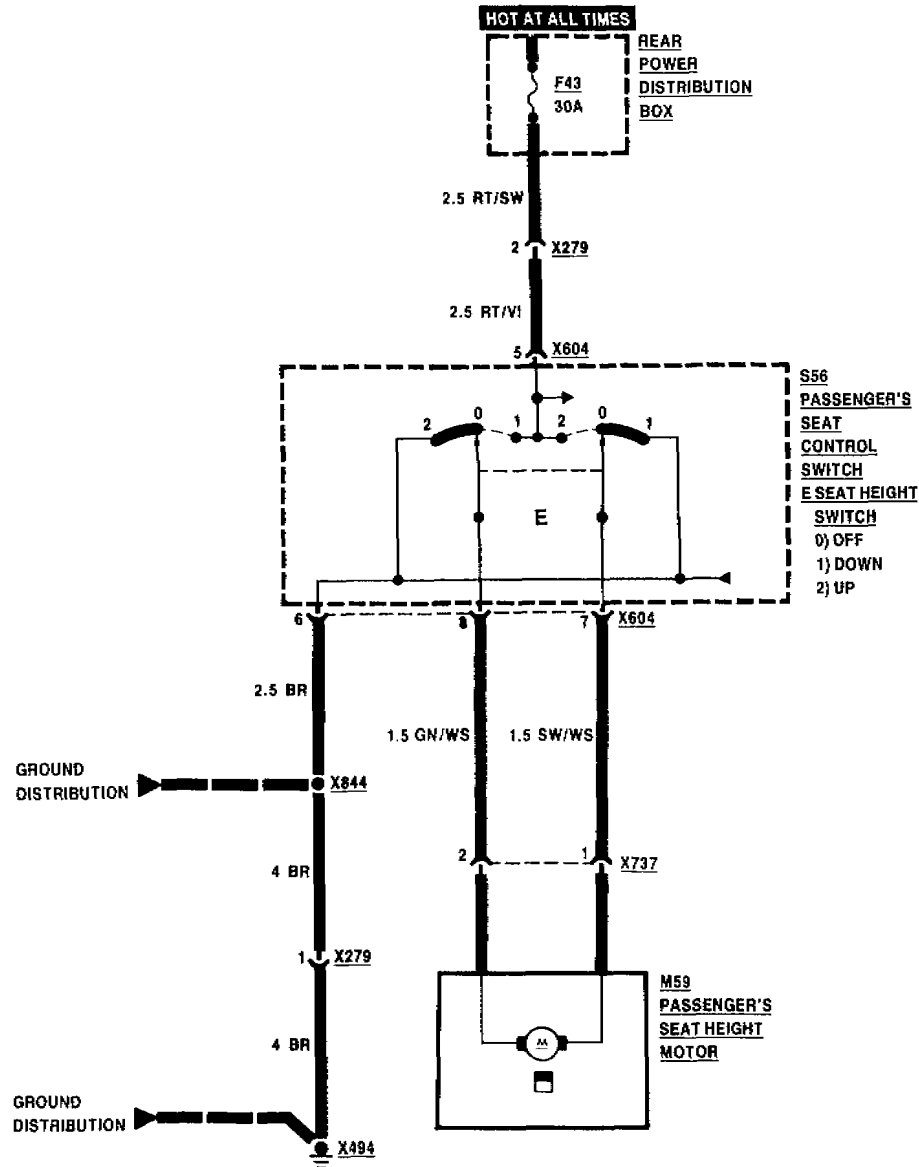

WIRE COLORS	
BL	BLUE
BR	BROWN
GE	YELLOW
GN	GREEN
GR	GRAY
OR	ORANGE
RS	PINK
RT	RED
SW	BLACK
VI	VIOLET
WS	WHITE



POWER SEATS
REAR SEATS

735iL, 750iL

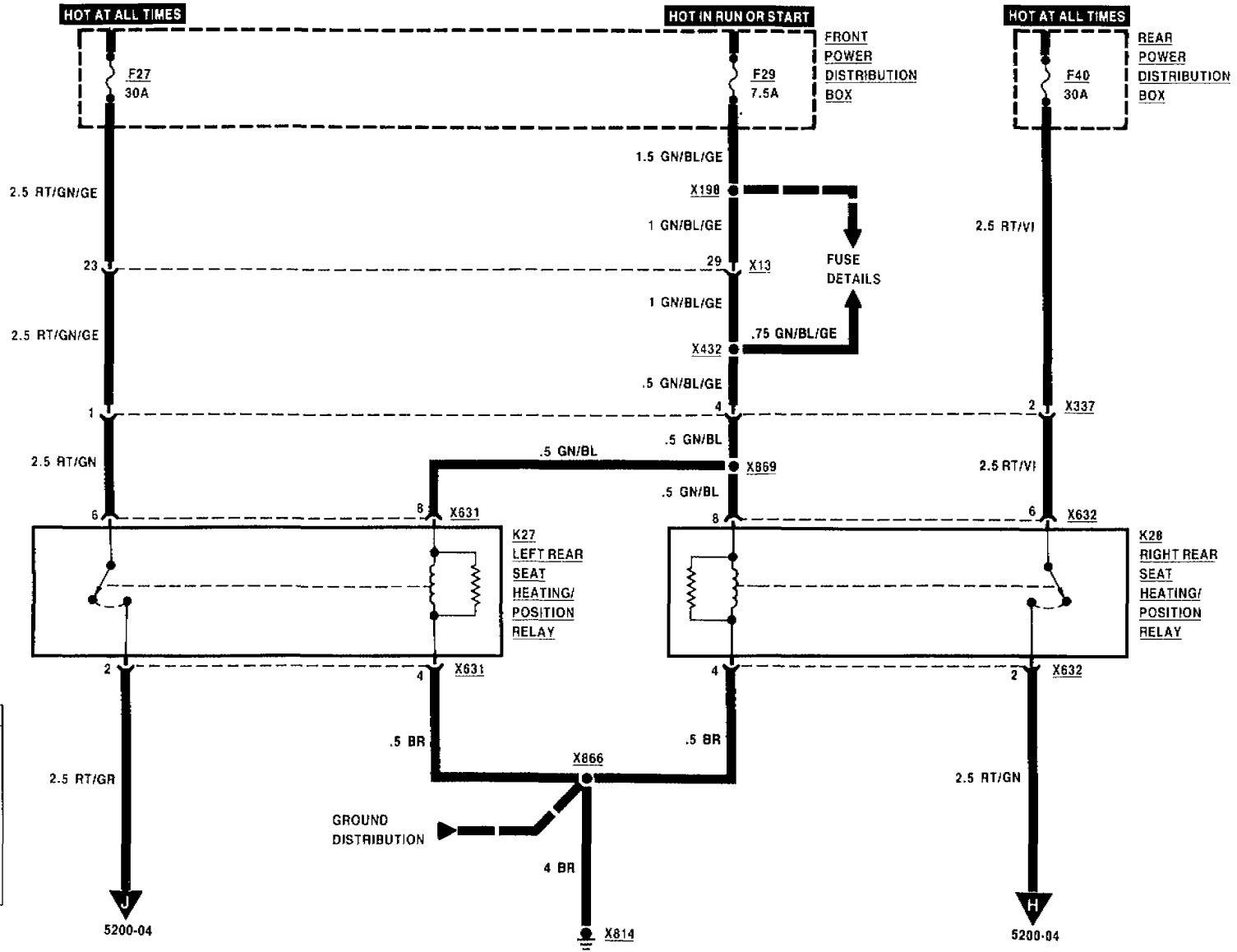

WIRE COLORS	
BL	BLUE
BR	BROWN
GE	YELLOW
GN	GREEN
GR	GRAY
OR	ORANGE
RS	PINK
RT	RED
SW	BLACK
VI	VIOLET
WS	WHITE

09/88

5200-03

1989



POWER SEATS

REAR SEATS

735iL, 750iL

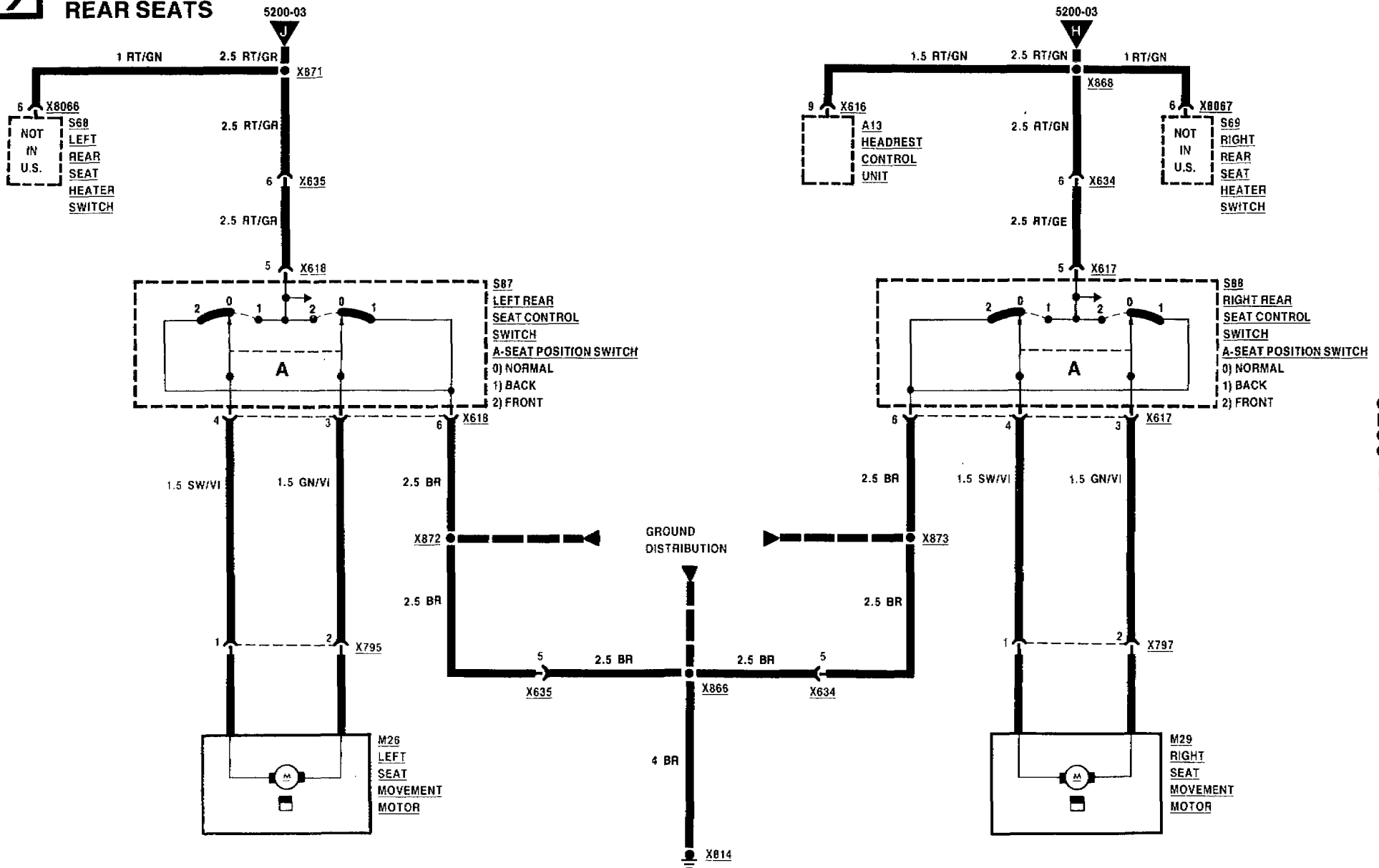

09/88

5200-04

1989



MEMORY SEAT

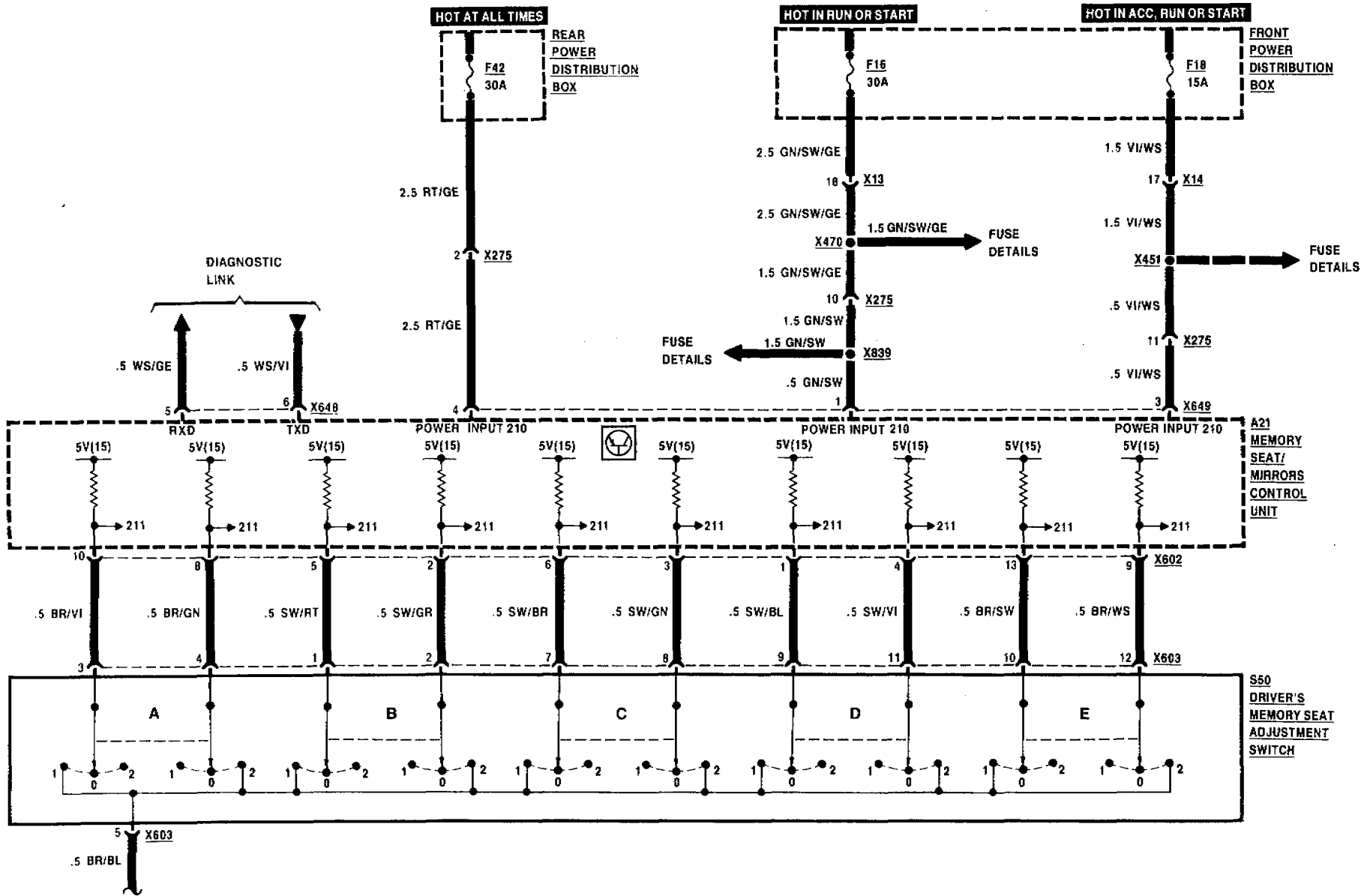

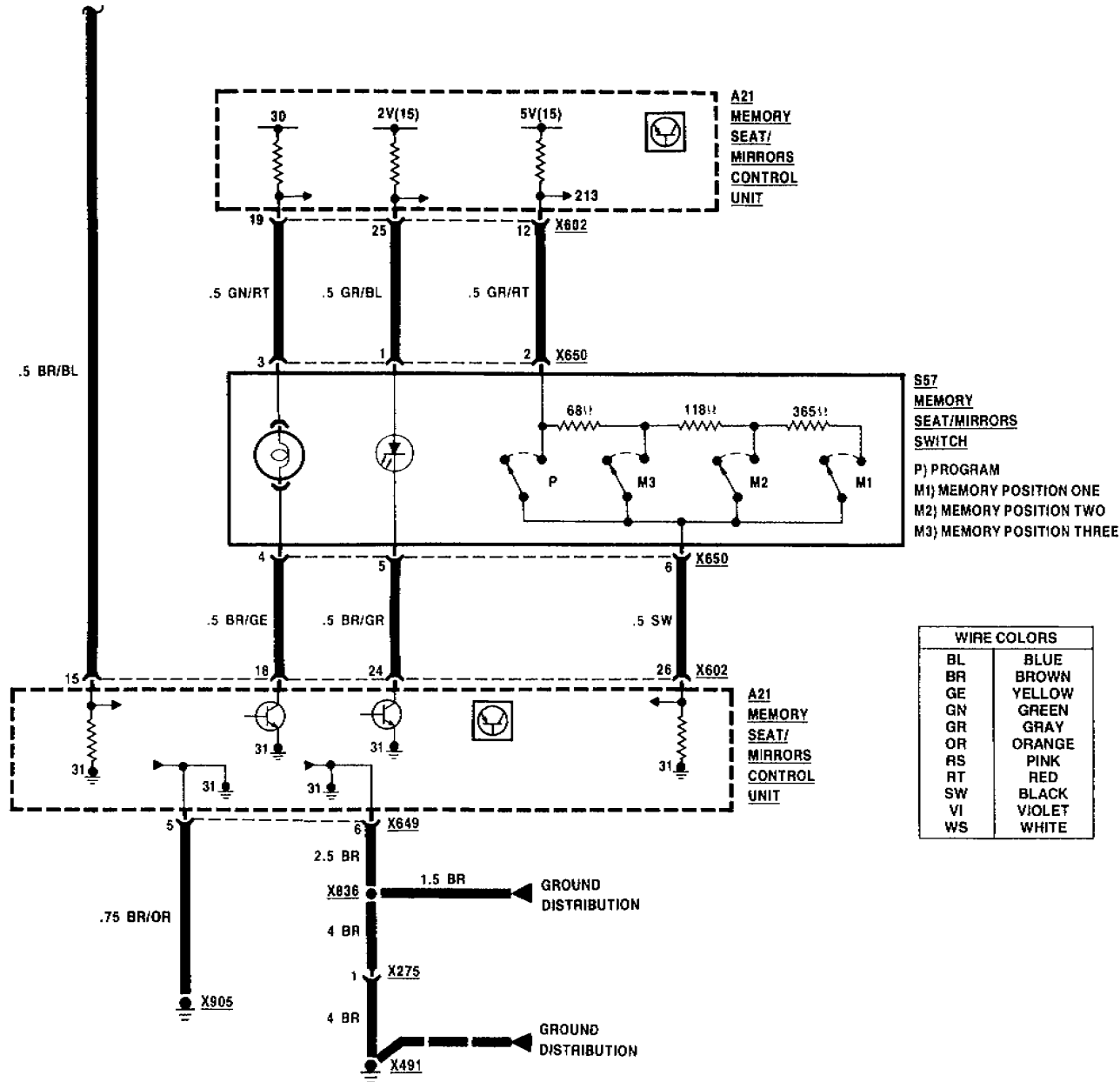

S50
DRIVER'S MEMORY SEAT ADJUSTMENT SWITCH

A SEAT POSITION SWITCH

- 0) OFF
- 1) FORWARD
- 2) BACK

B SEAT CUSHION TILT SWITCH

- 0) OFF
- 1) UP
- 2) DOWN

C SEAT HEIGHT SWITCH

- 0) OFF
- 1) UP
- 2) DOWN

D HEADREST SWITCH

- 0) OFF
- 1) UP
- 2) DOWN

E SEATBACK SWITCH

- 0) OFF
- 1) FRONT
- 2) BACK

BMW 7 MEMORY SEAT

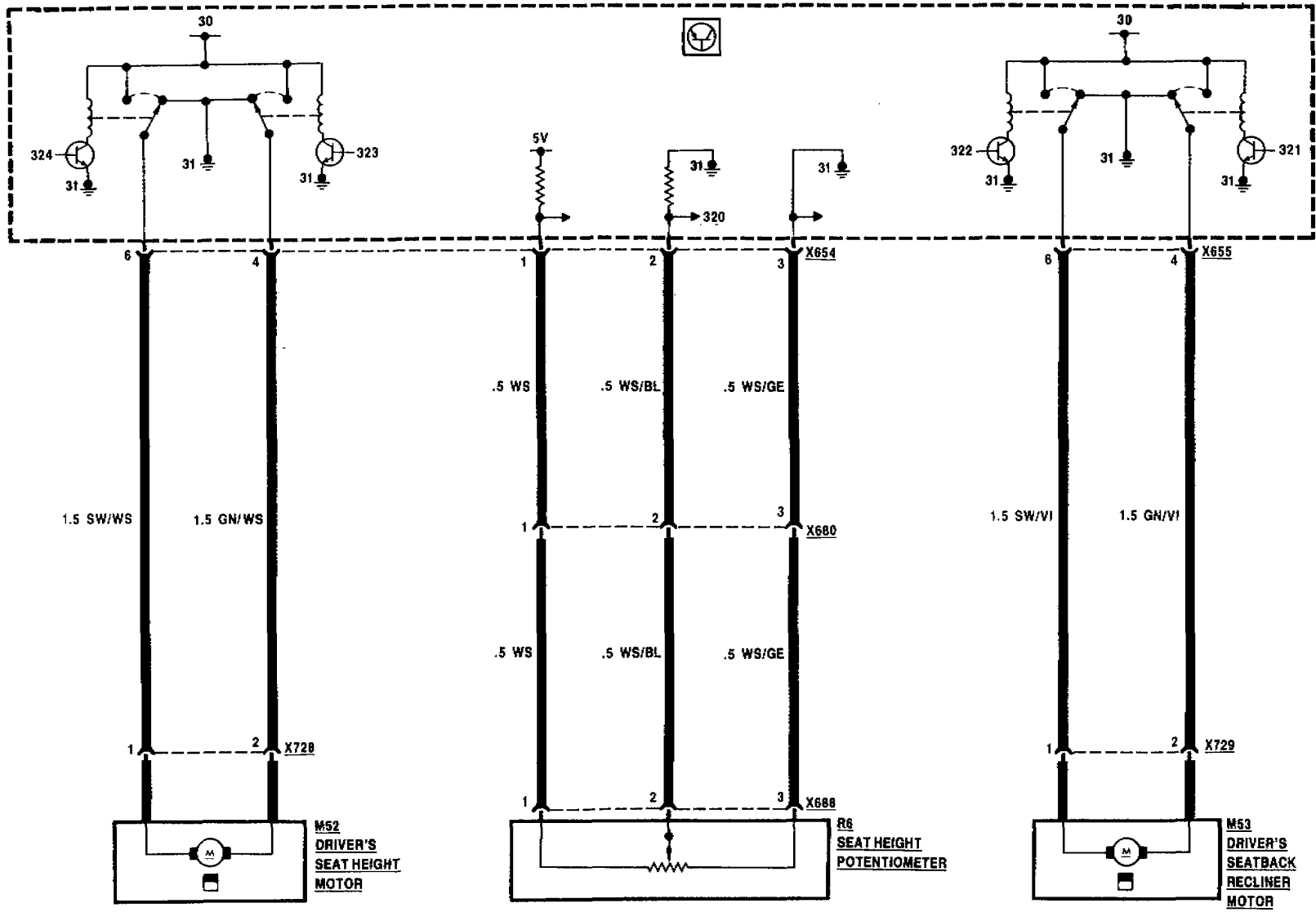

A21
MEMORY
SEAT/MIRRORS
CONTROL UNIT

WIRE COLORS	
BL	BLUE
BR	BROWN
GE	YELLOW
GN	GREEN
GR	GRAY
OR	ORANGE
RS	PINK
RT	RED
SW	BLACK
VI	VIOLET
WS	WHITE



MEMORY SEAT

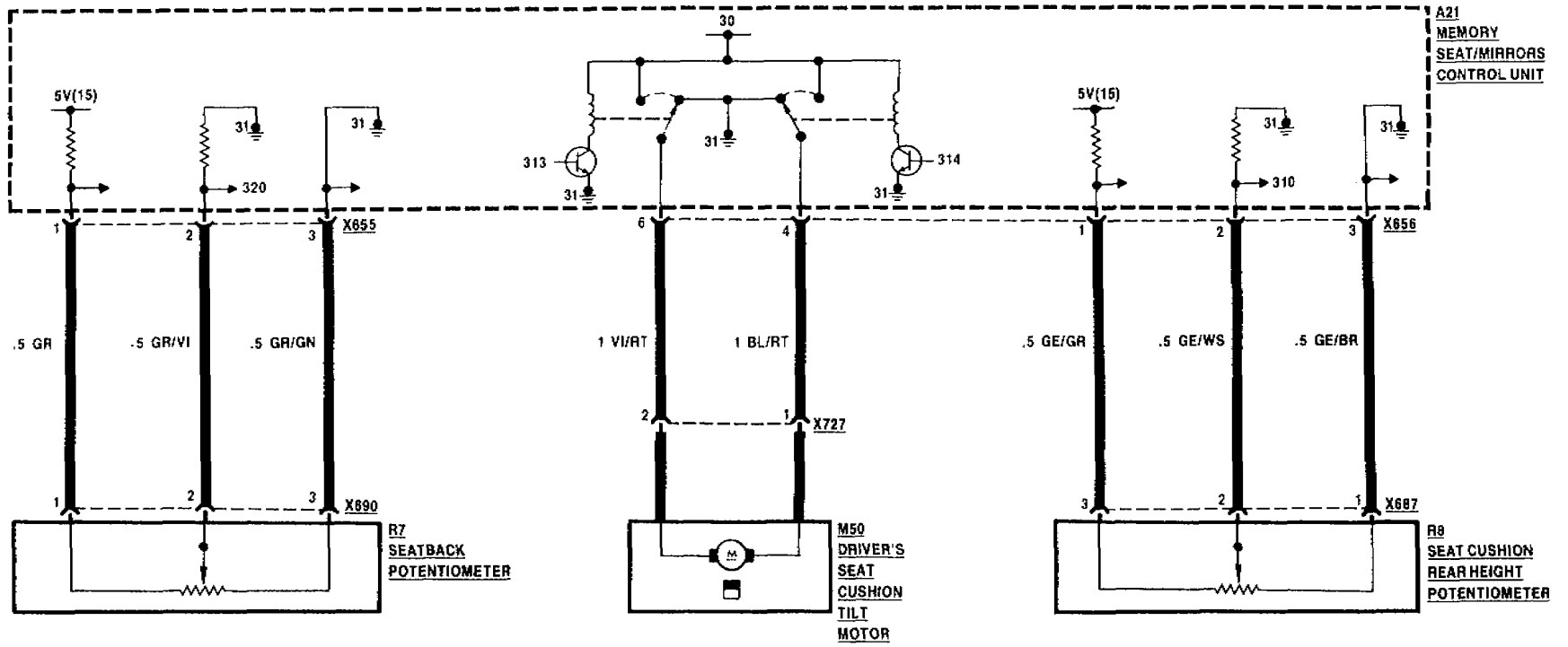



MEMORY SEAT

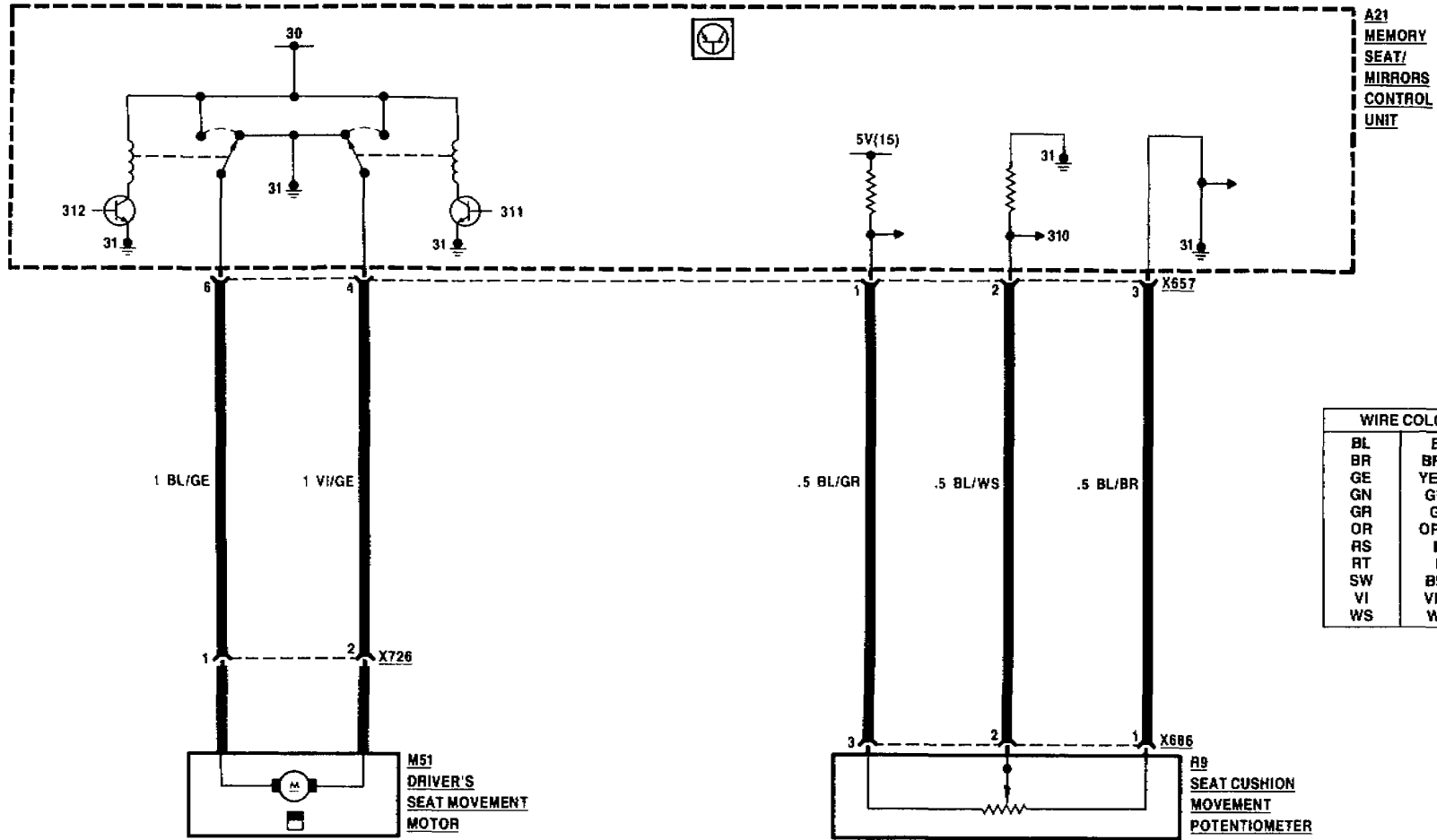

BMW
7 **MEMORY SEAT**

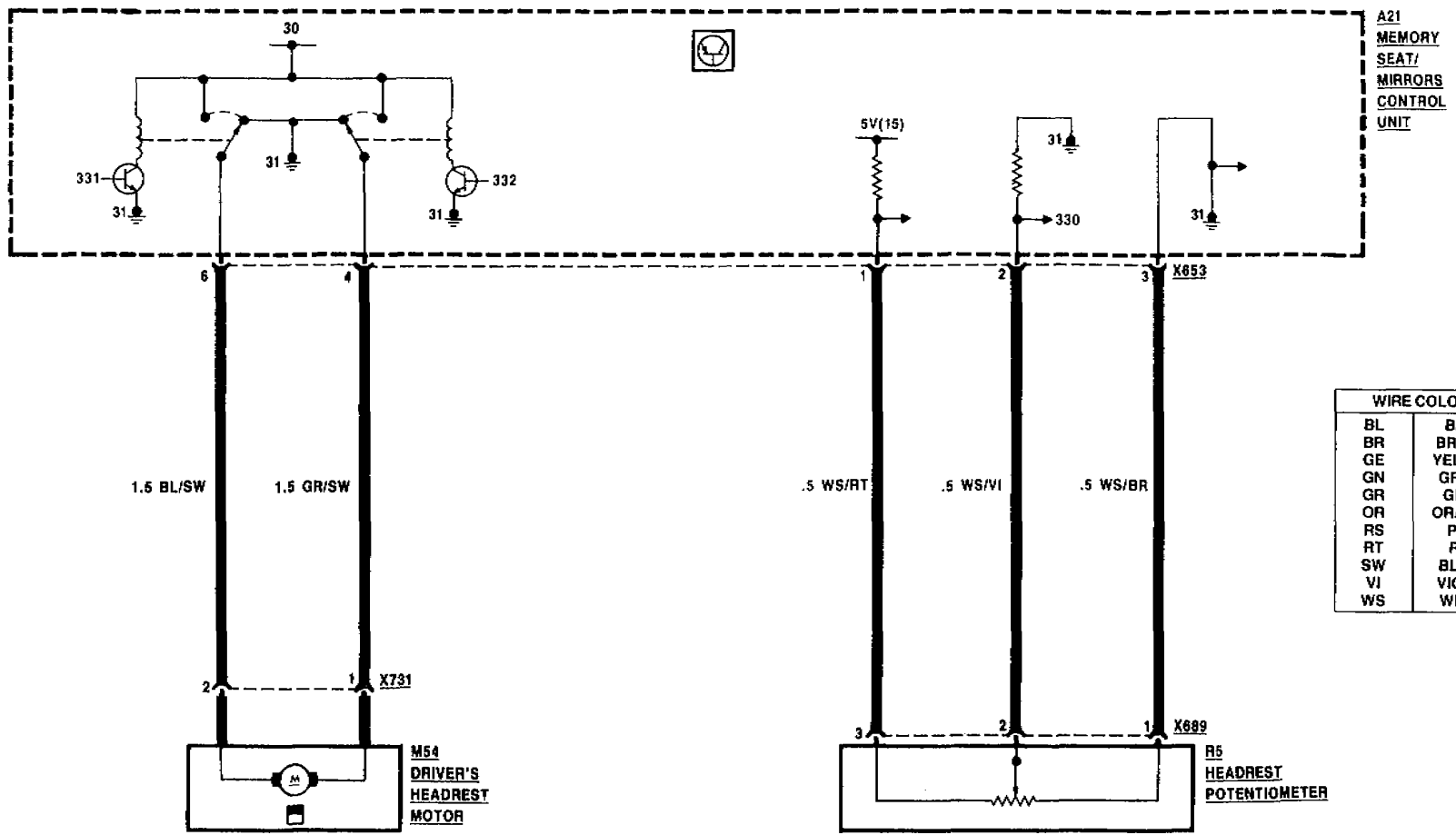

WIRE COLORS	
BL	BLUE
BR	BROWN
GE	YELLOW
GN	GREEN
GR	GRAY
OR	ORANGE
RS	PINK
RT	RED
SW	BLACK
VI	VIOLET
WS	WHITE

MEMORY SEAT

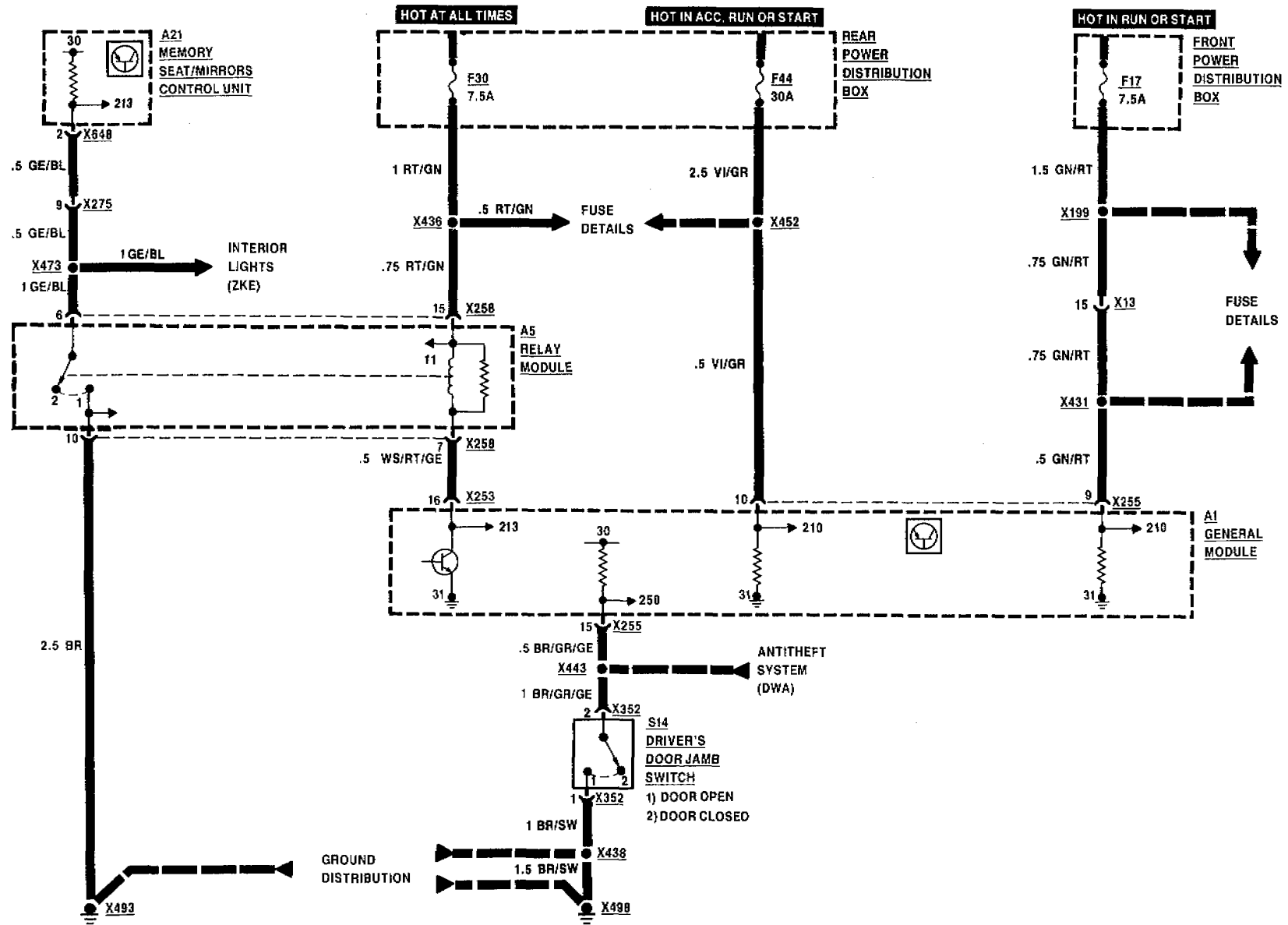



LUMBAR SUPPORT DRIVER'S SEAT WITH MEMORY

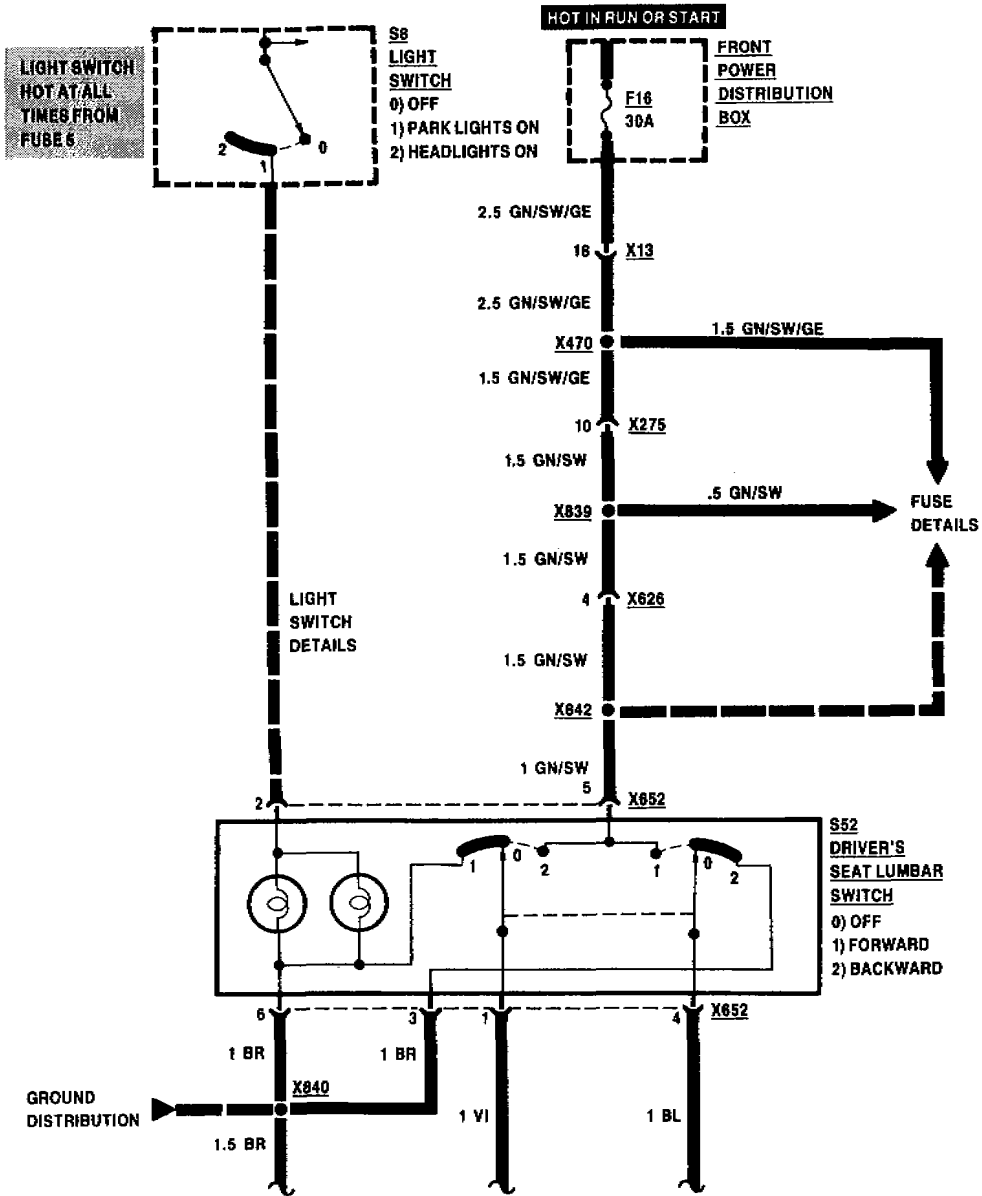

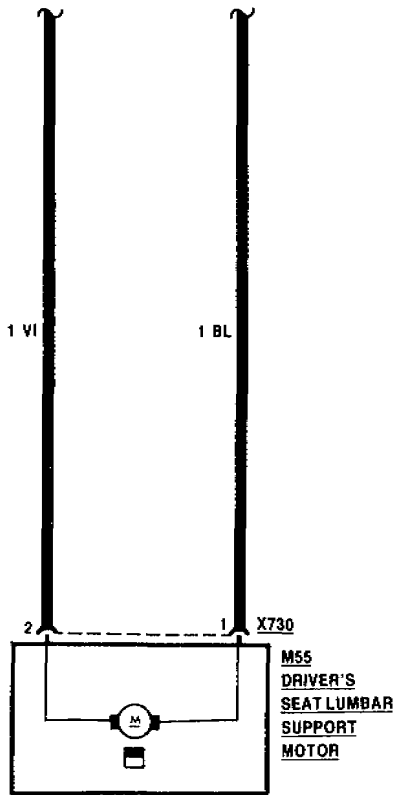
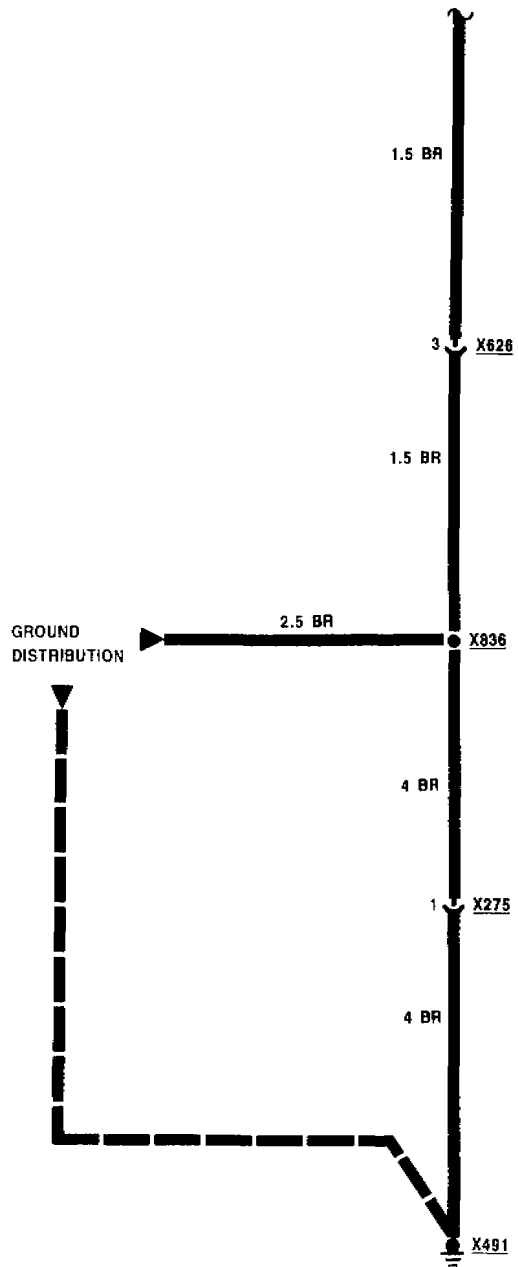

WIRE COLORS	
BL	BLUE
BR	BROWN
GE	YELLOW
GN	GREEN
GR	GRAY
OR	ORANGE
RS	PINK
RT	RED
SW	BLACK
VI	VIOLET
WS	WHITE



HEATED SEATS

DRIVER'S SEAT WITH MEMORY

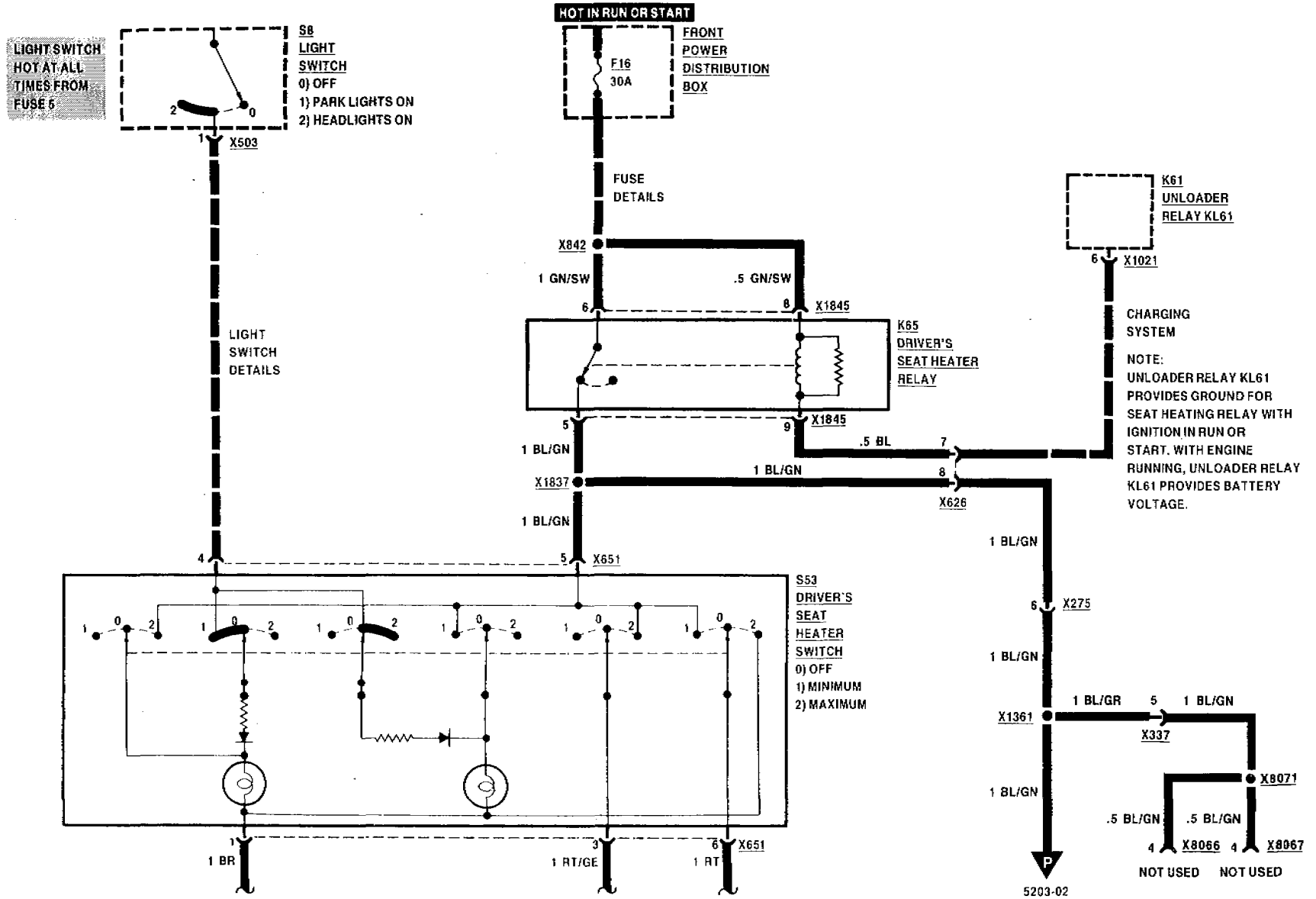

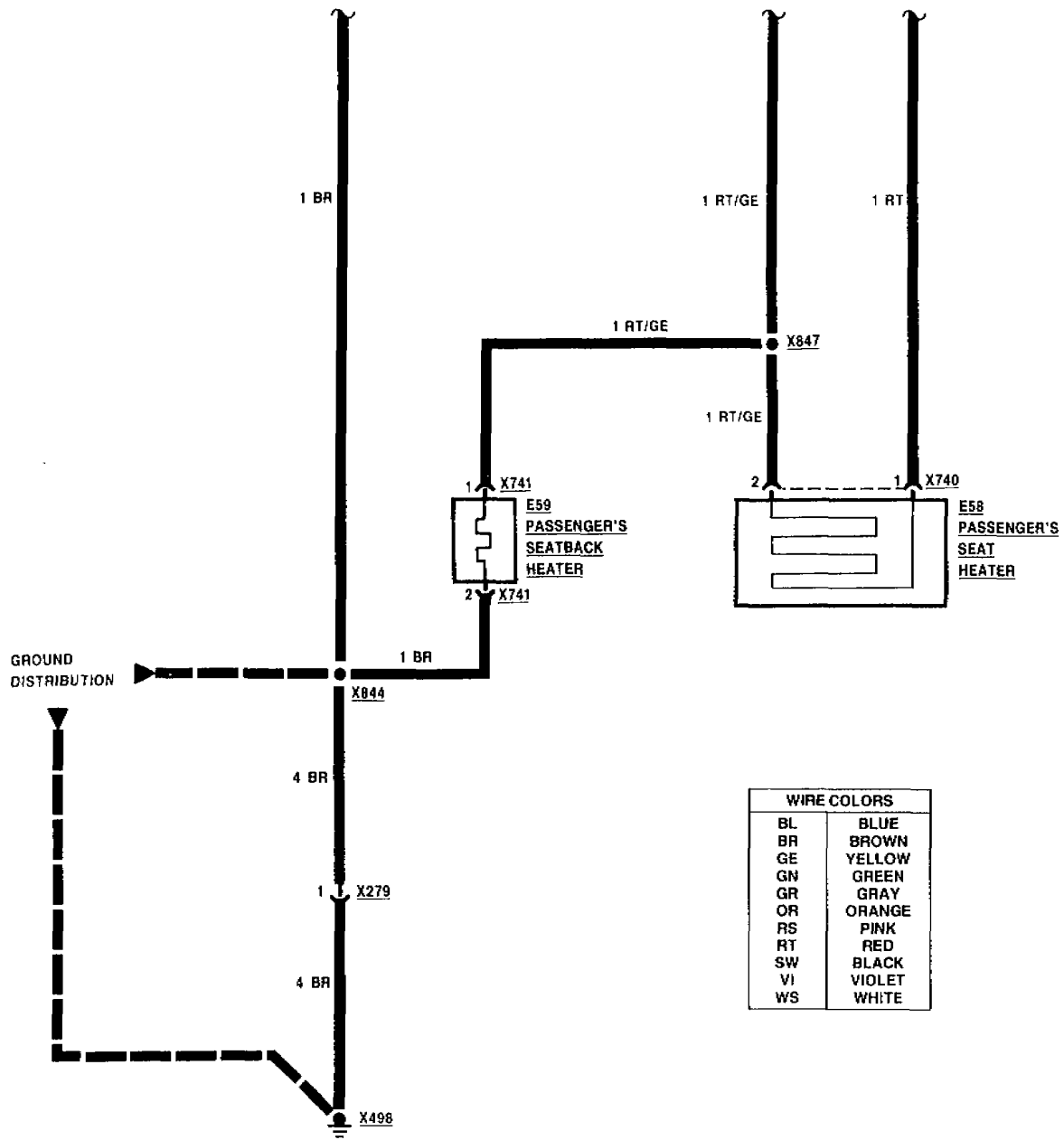



HEATED SEATS PASSENGER'S SEAT

WIRE COLORS	
BL	BLUE
BR	BROWN
GE	YELLOW
GN	GREEN
GR	GRAY
OR	ORANGE
RS	PINK
RT	RED
SW	BLACK
VI	VIOLET
WS	WHITE

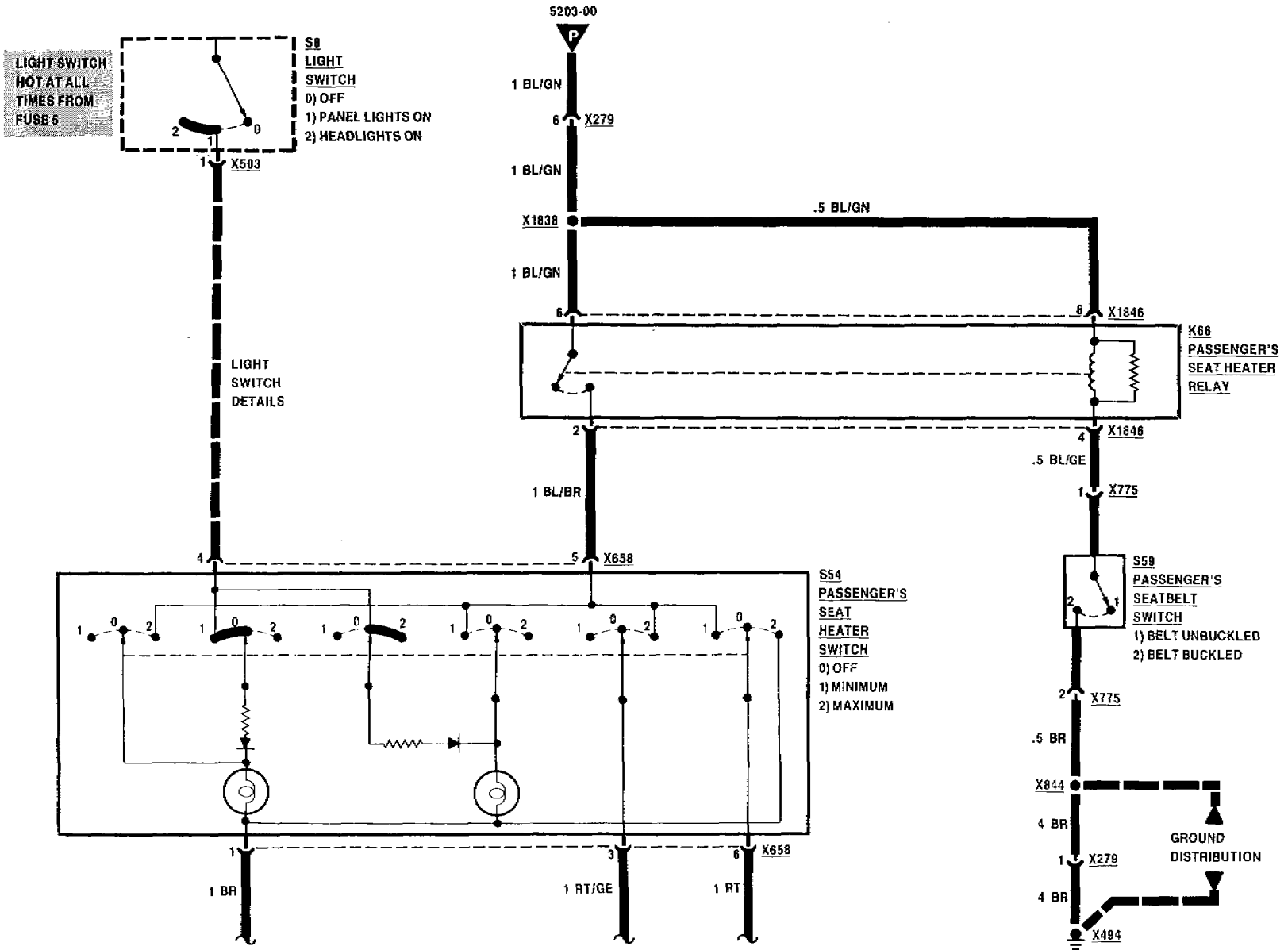

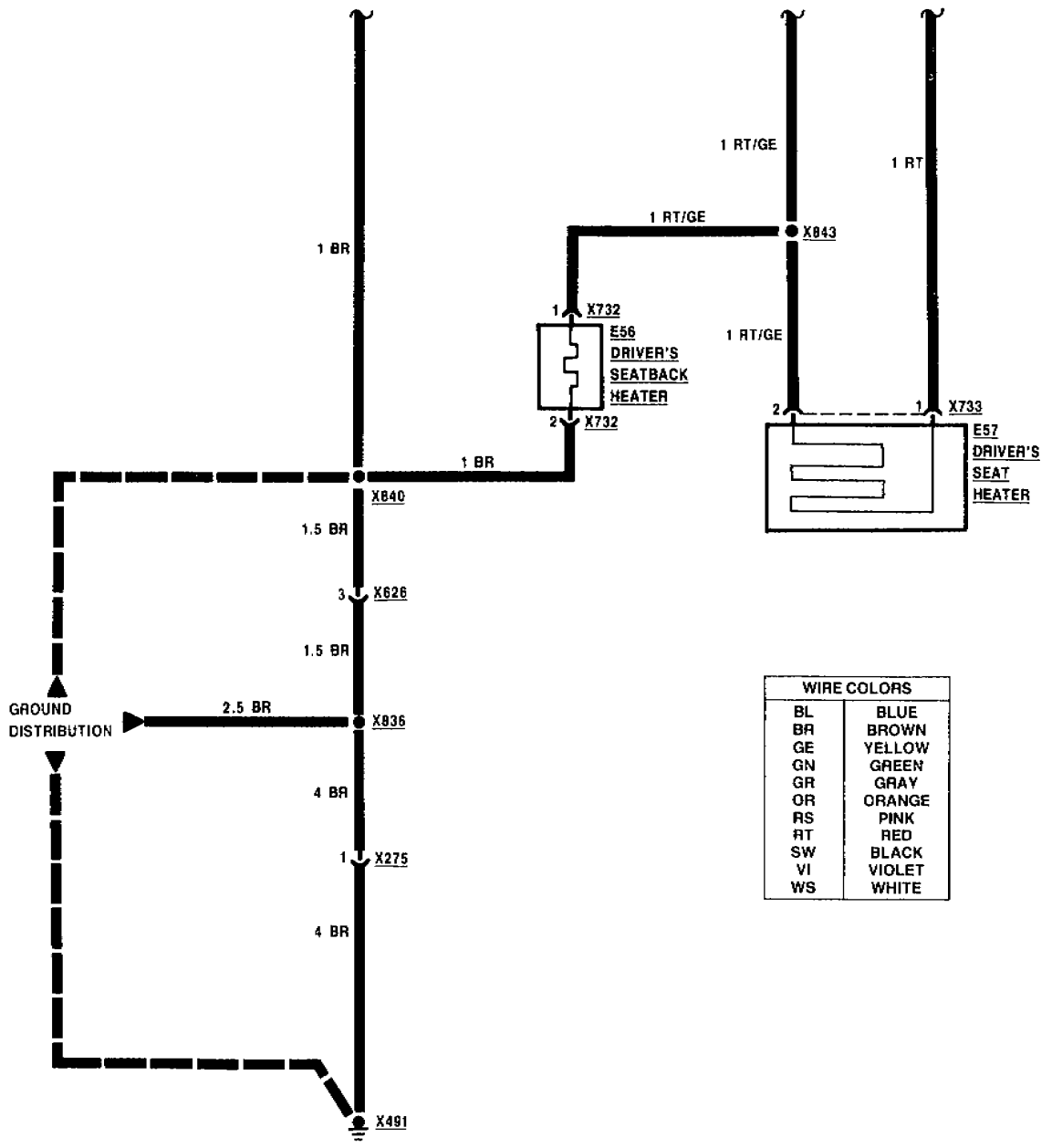

WIRE COLORS	
BL	BLUE
BR	BROWN
GE	YELLOW
GN	GREEN
GR	GRAY
OR	ORANGE
RS	PINK
RT	RED
SW	BLACK
VI	VIOLET
WS	WHITE



AUTOMATIC REAR HEADREST

735i, 735iL

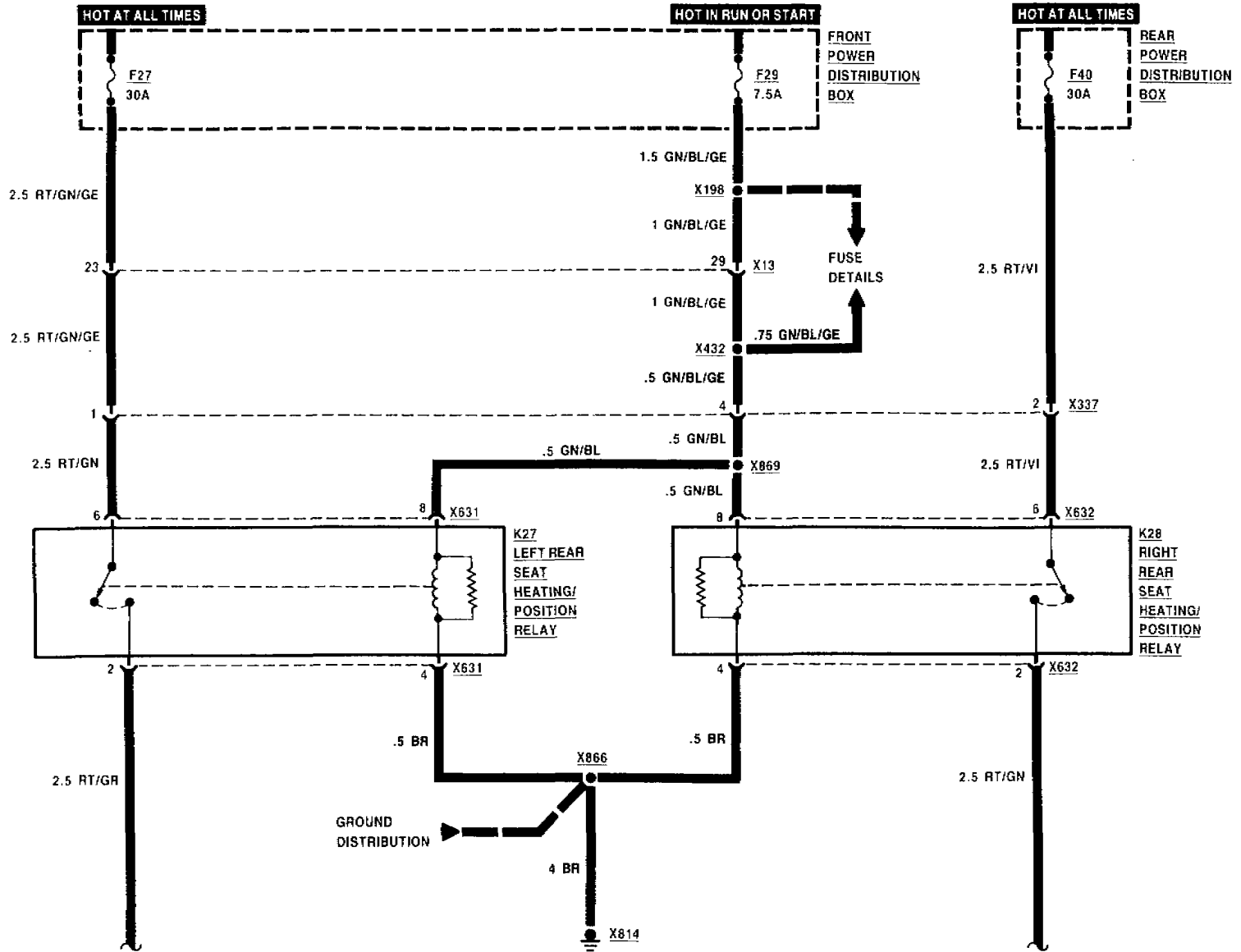

WIRE COLORS	
BL	BLUE
BR	BROWN
GE	YELLOW
GN	GREEN
GR	GRAY
OR	ORANGE
RS	PINK
RT	RED
SW	BLACK
VI	VIOLET
WS	WHITE

09/88

5205-00

1989

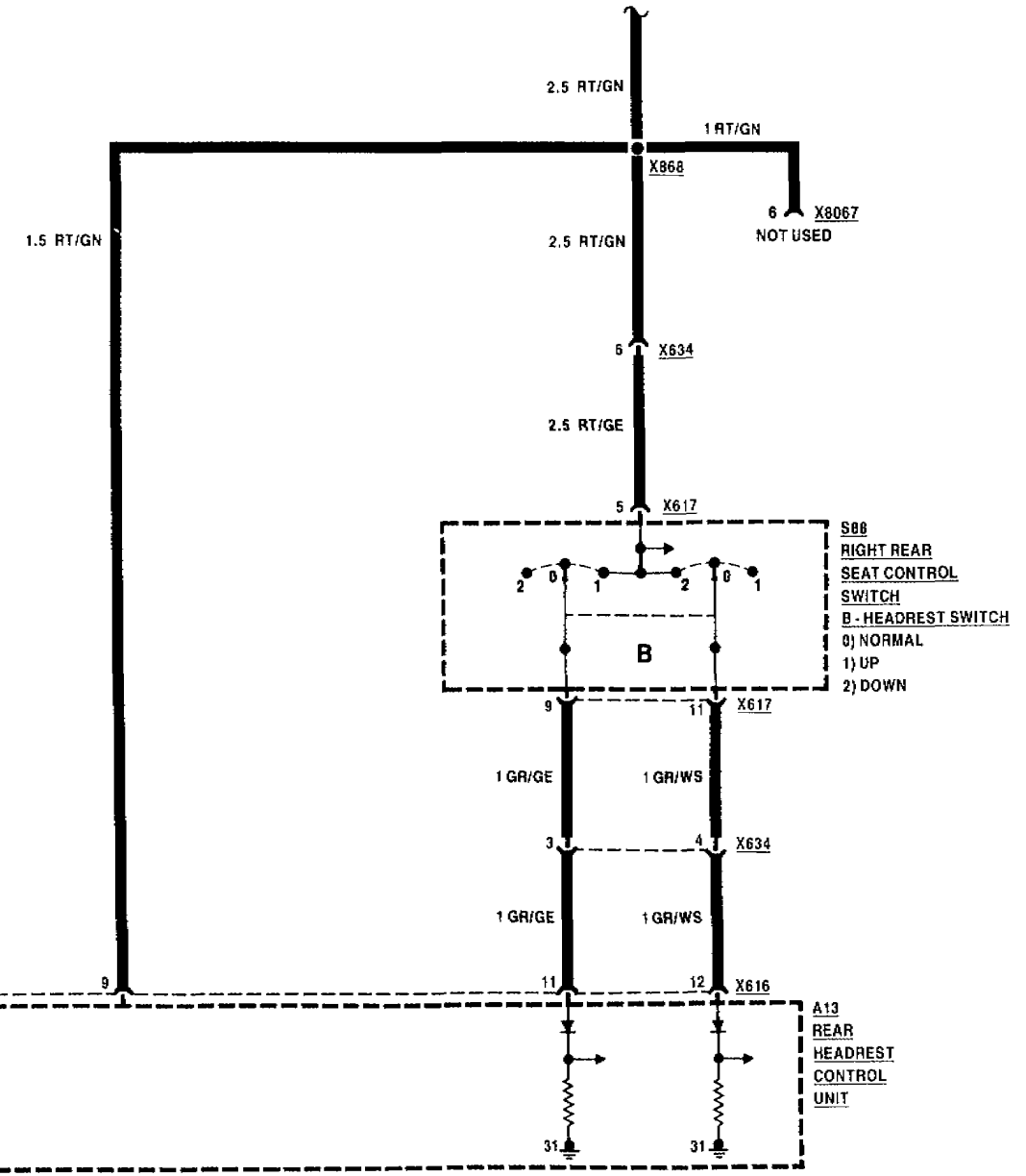
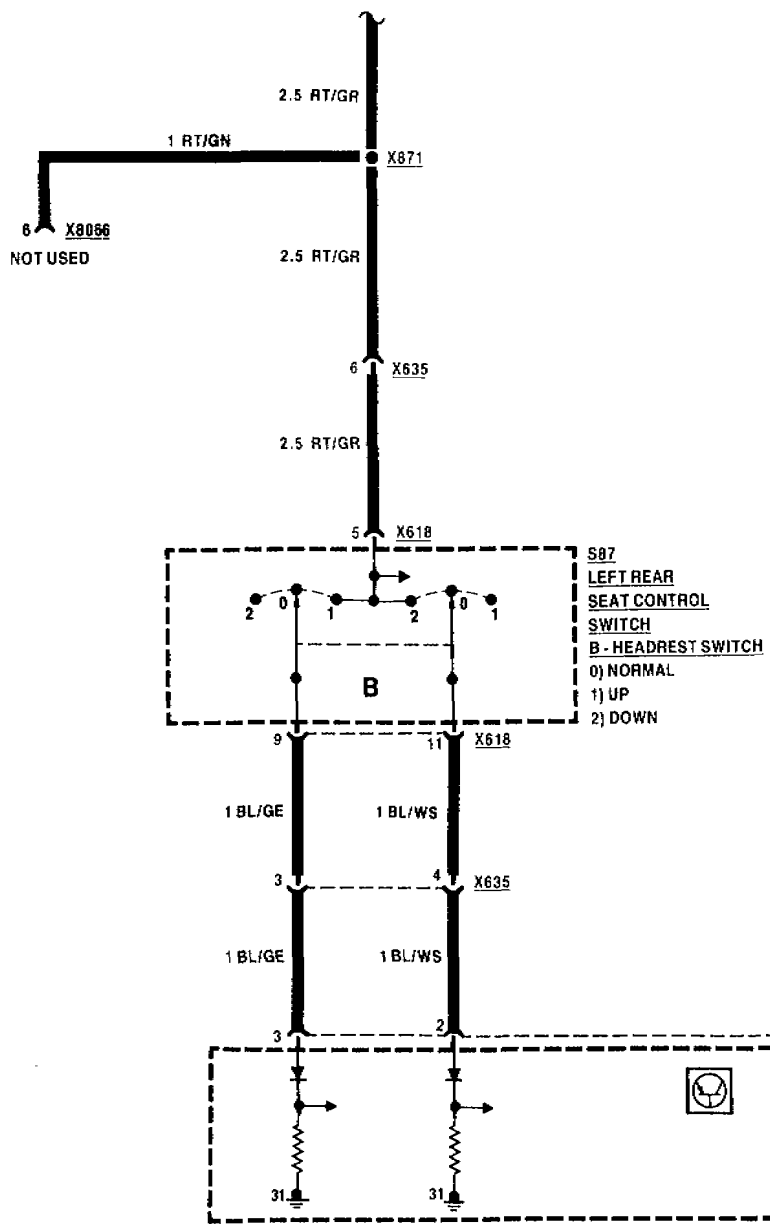



AUTOMATIC REAR HEADREST

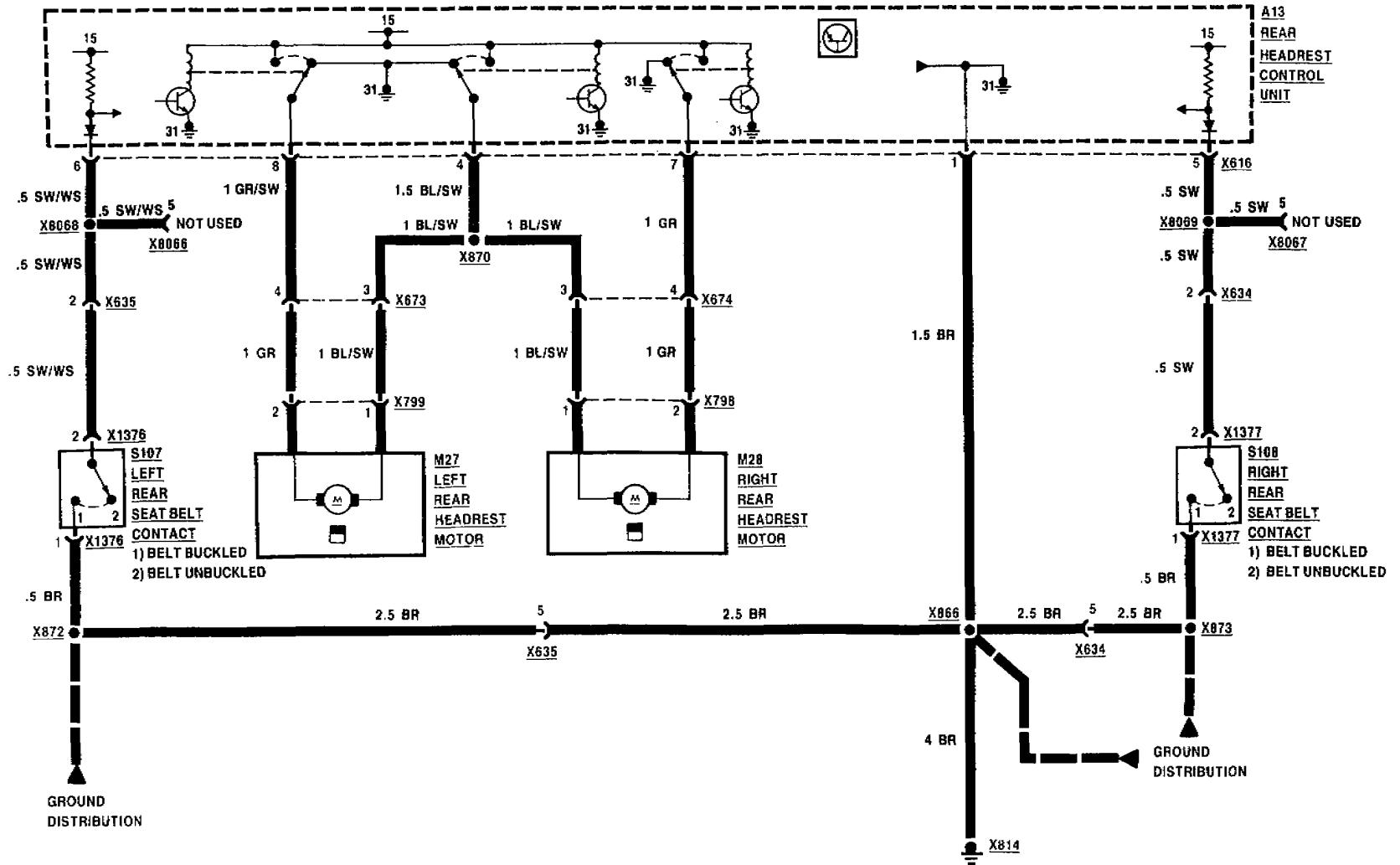



SUNROOF (ZKE) INPUT DETAILS

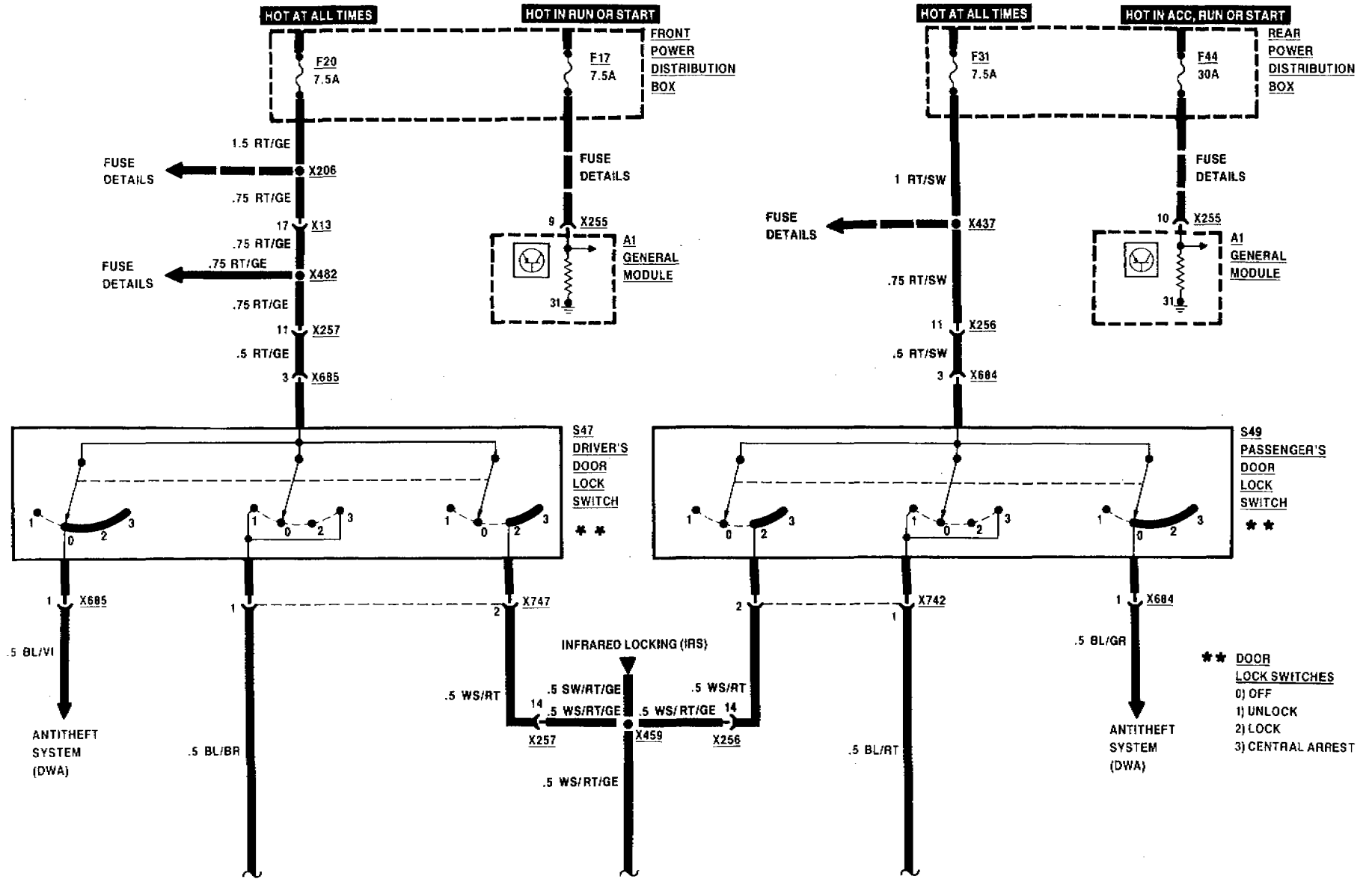

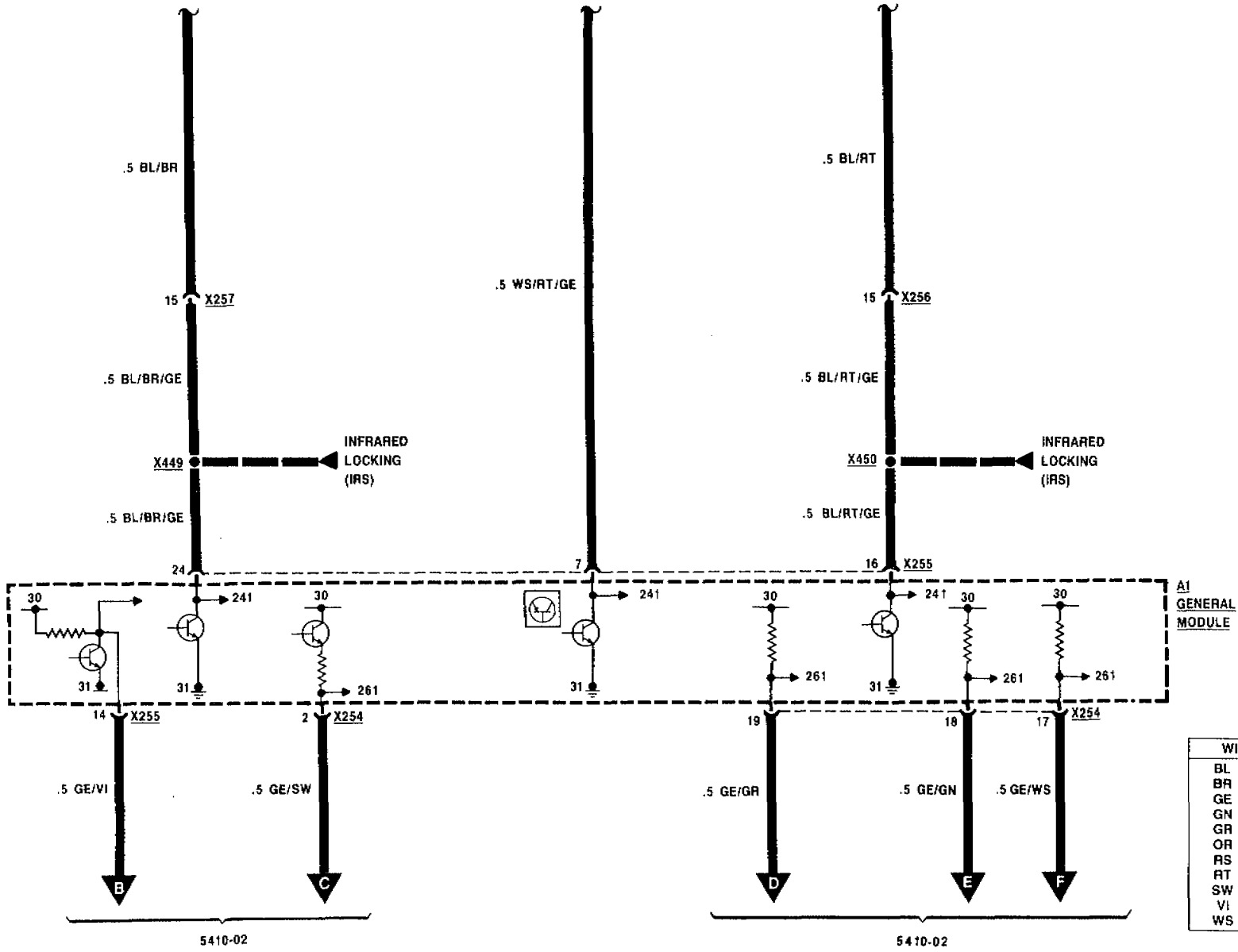

5410-02

5410-02



SUNROOF (ZKE)

INPUT DETAILS

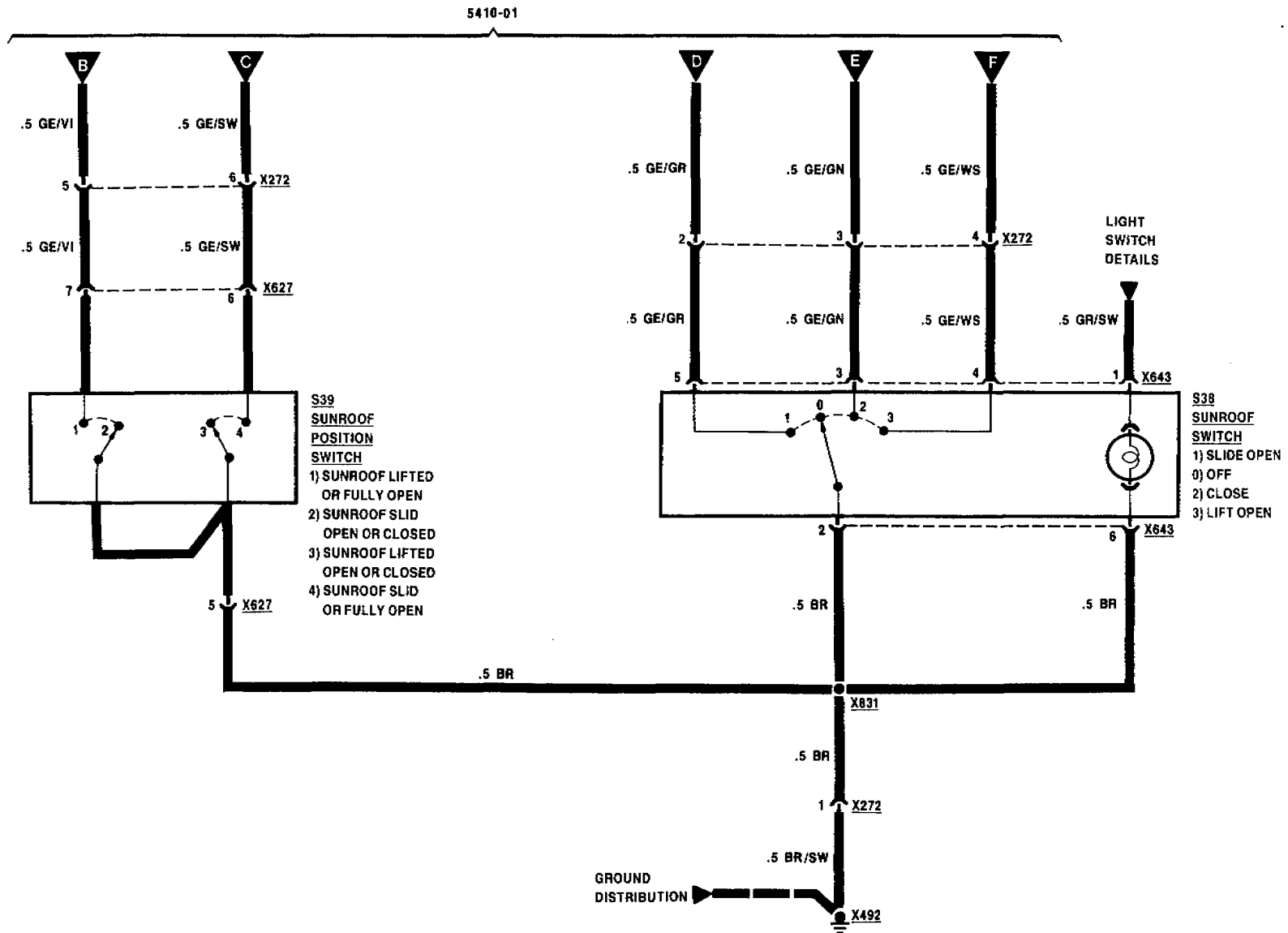



SUNROOF (ZKE)

OUTPUT DETAILS

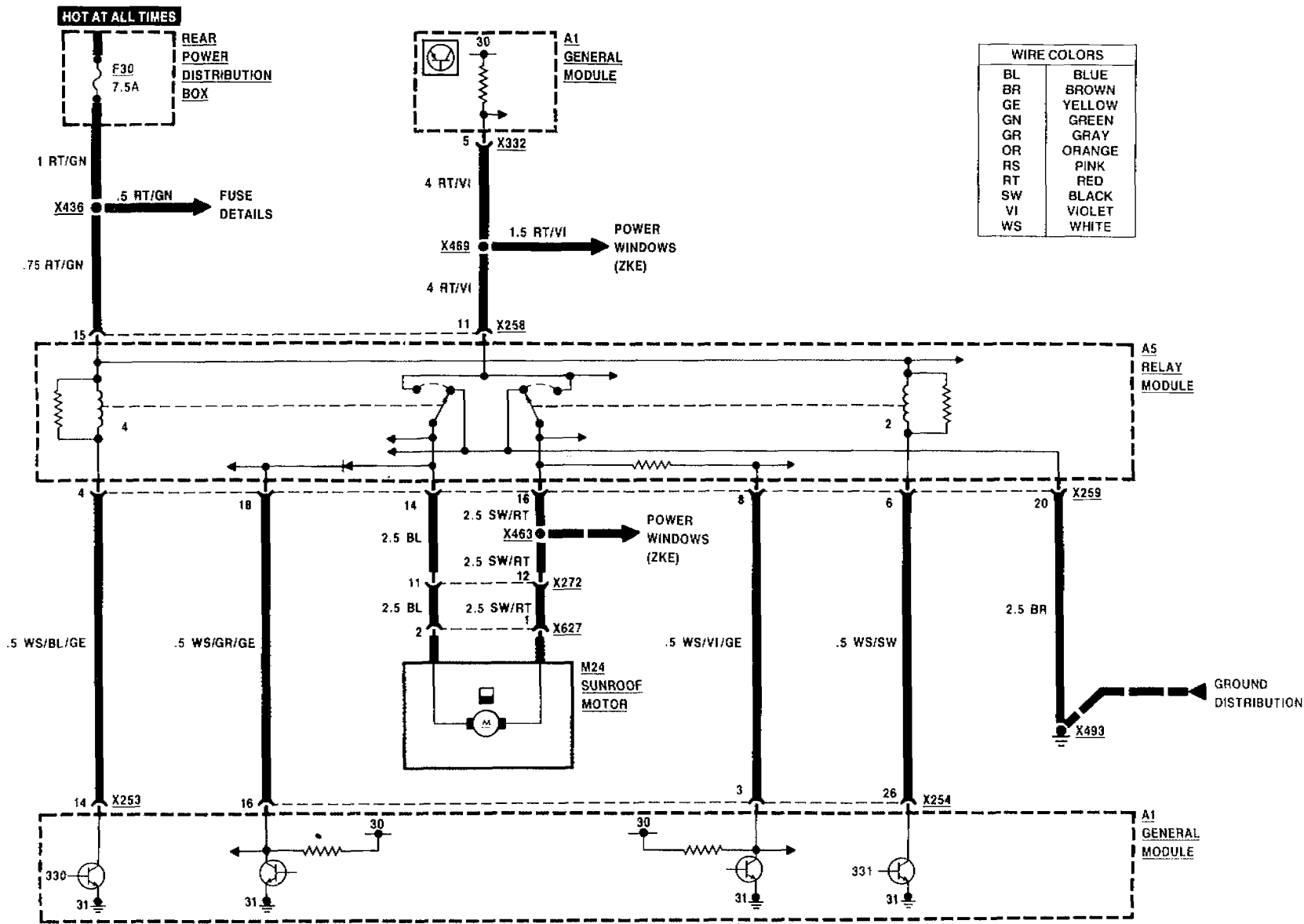



CENTRAL BODY ELECTRONICS (ZKE)

GENERAL MODULE

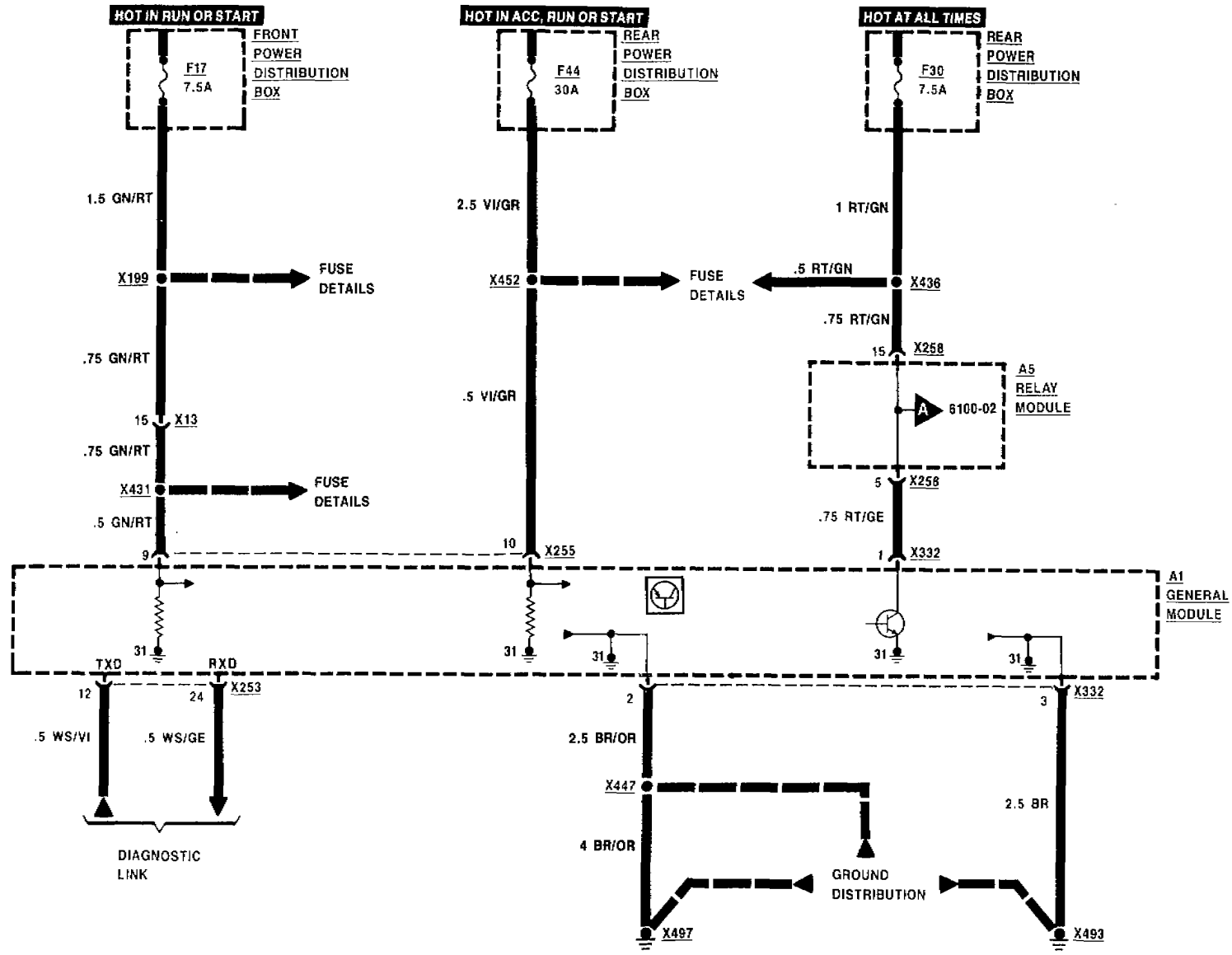



CENTRAL BODY ELECTRONICS (ZKE) GENERAL MODULE

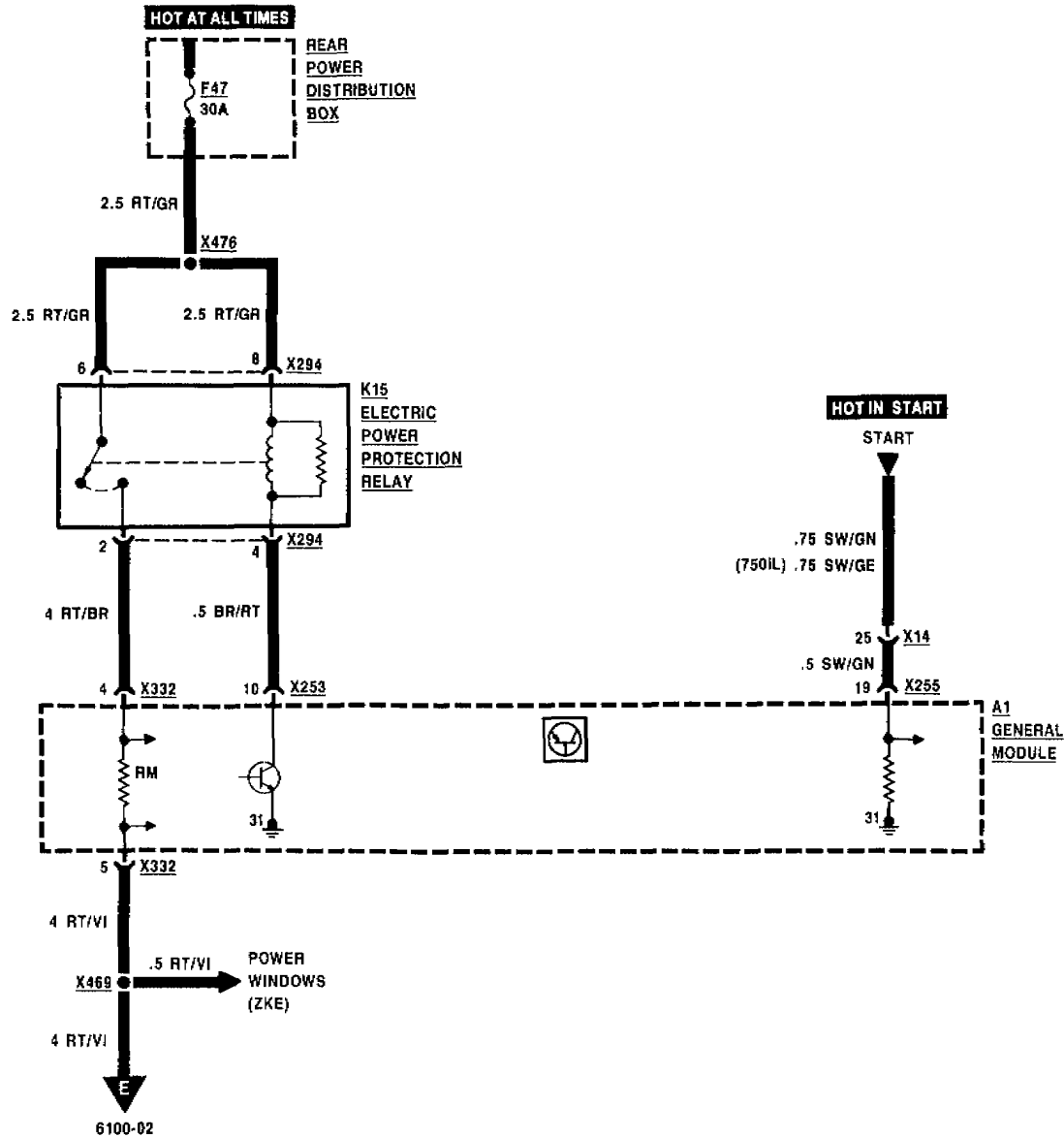

**BMW 7 CENTRAL BODY ELECTRONICS (ZKE)
RELAY MODULE**

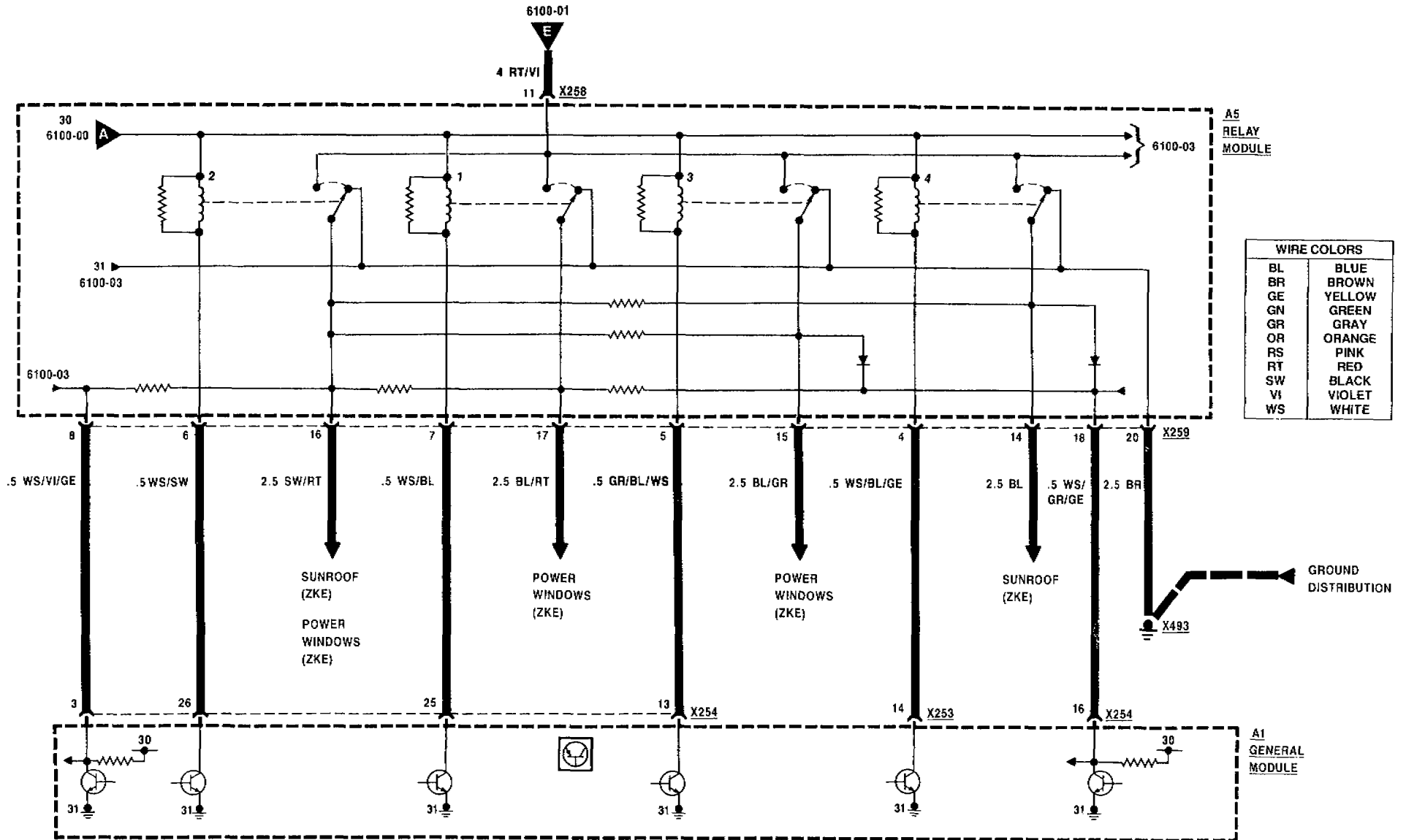

11/89

6100-02

1989



CENTRAL BODY ELECTRONICS (ZKE) RELAY MODULE

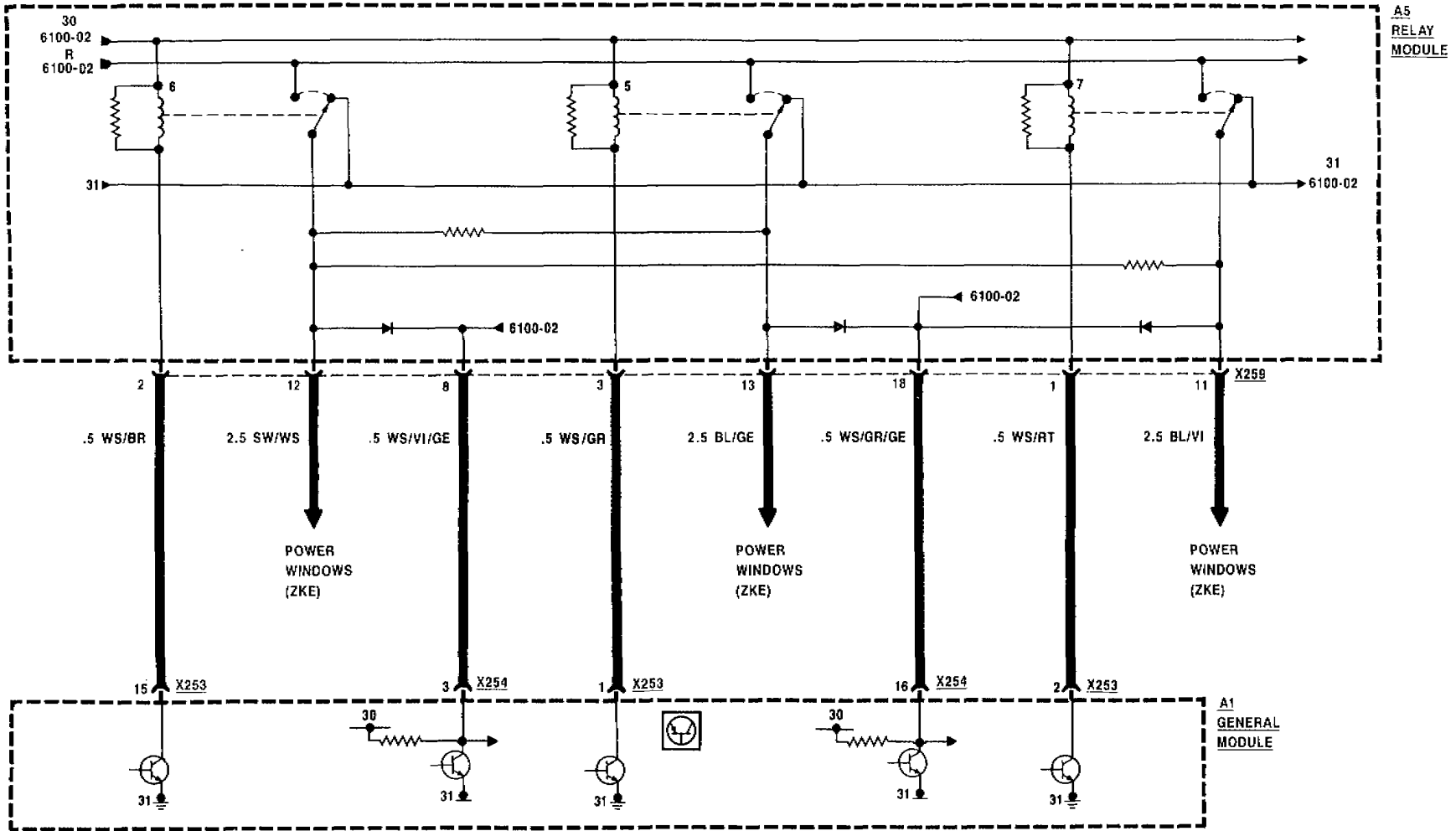



CENTRAL BODY ELECTRONICS (ZKE) RELAY MODULE

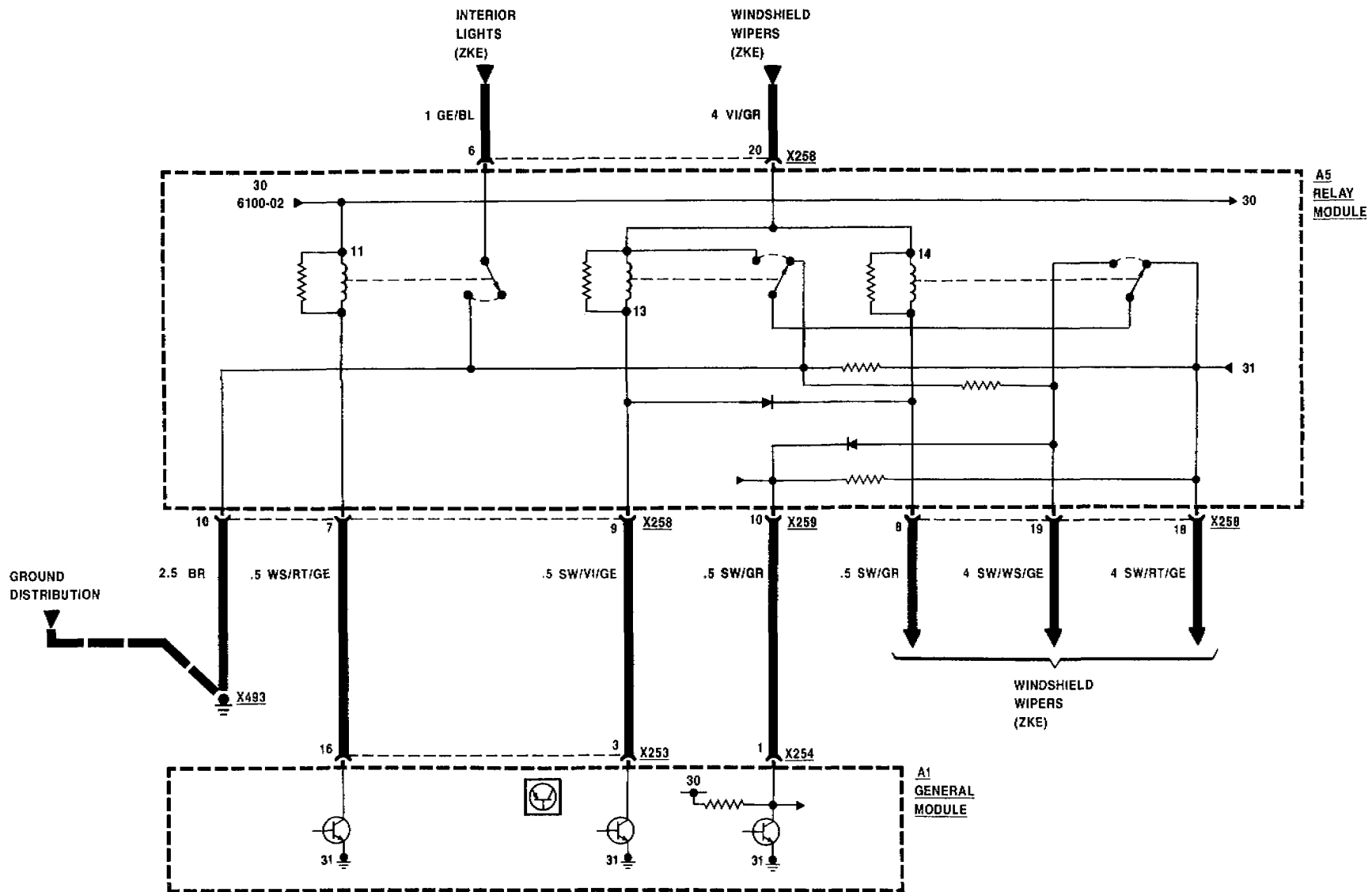



CENTRAL BODY ELECTRONICS (ZKE) RELAY MODULE

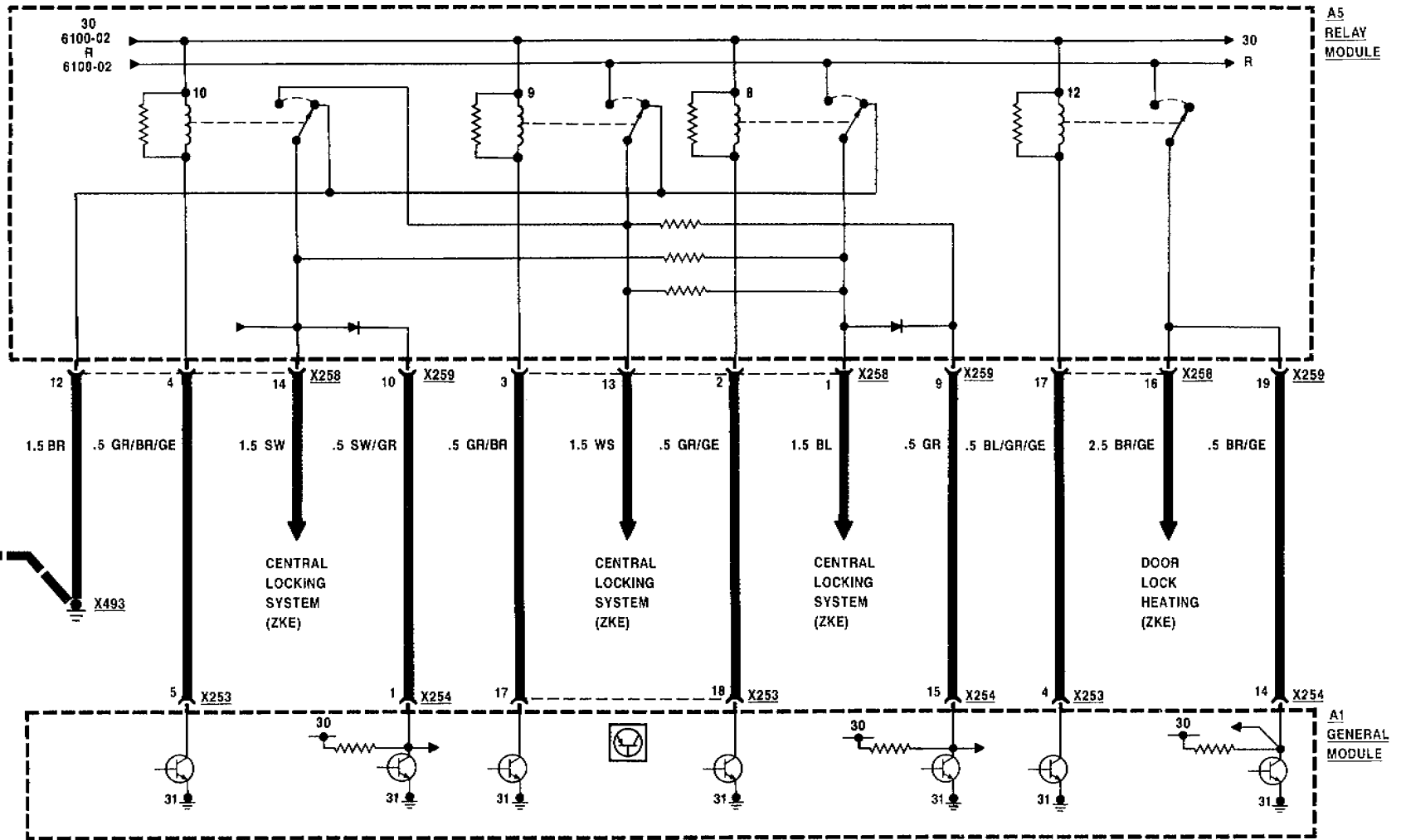

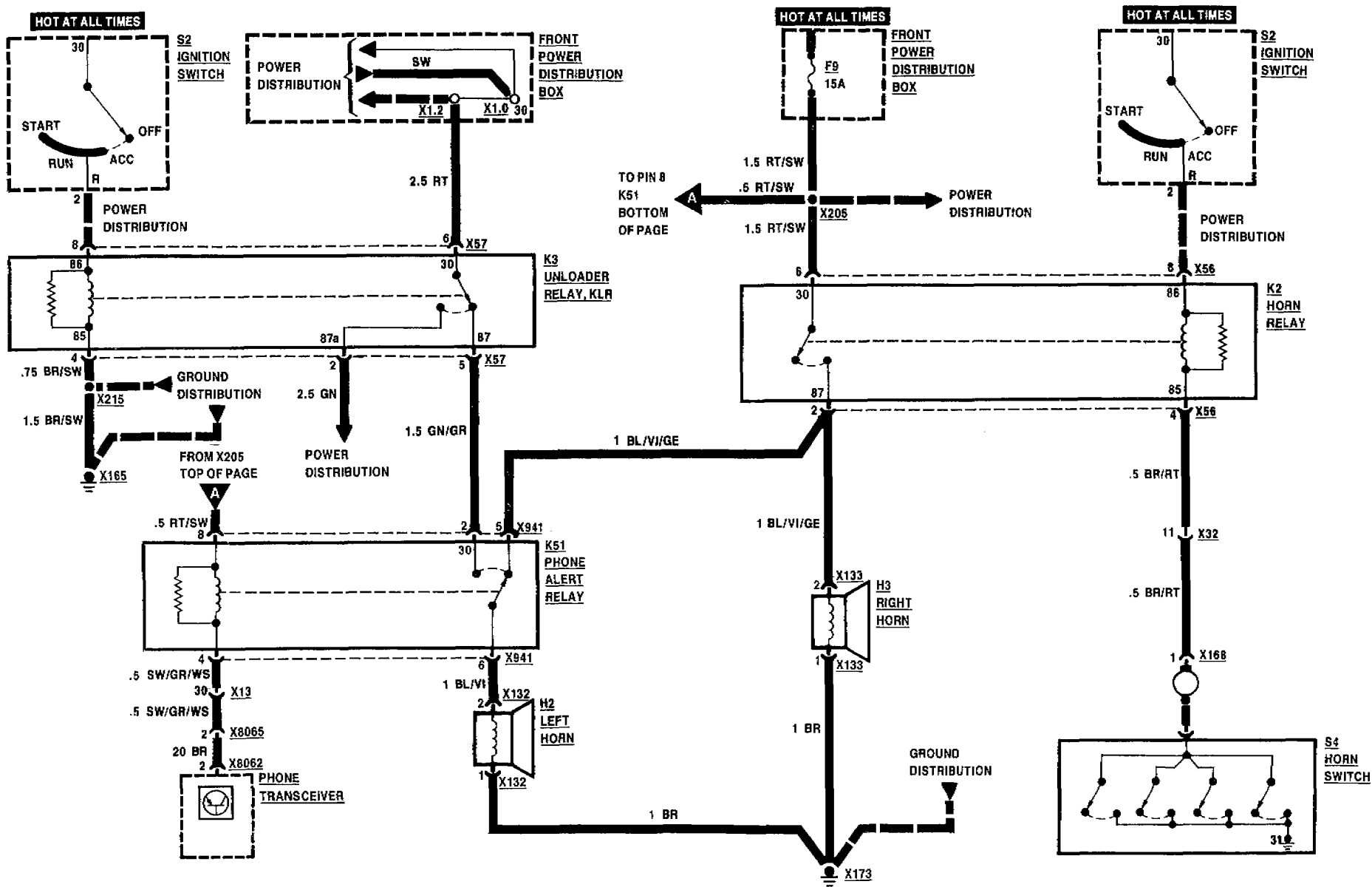



WINDSHIELD WIPERS (ZKE)

INPUT DETAILS

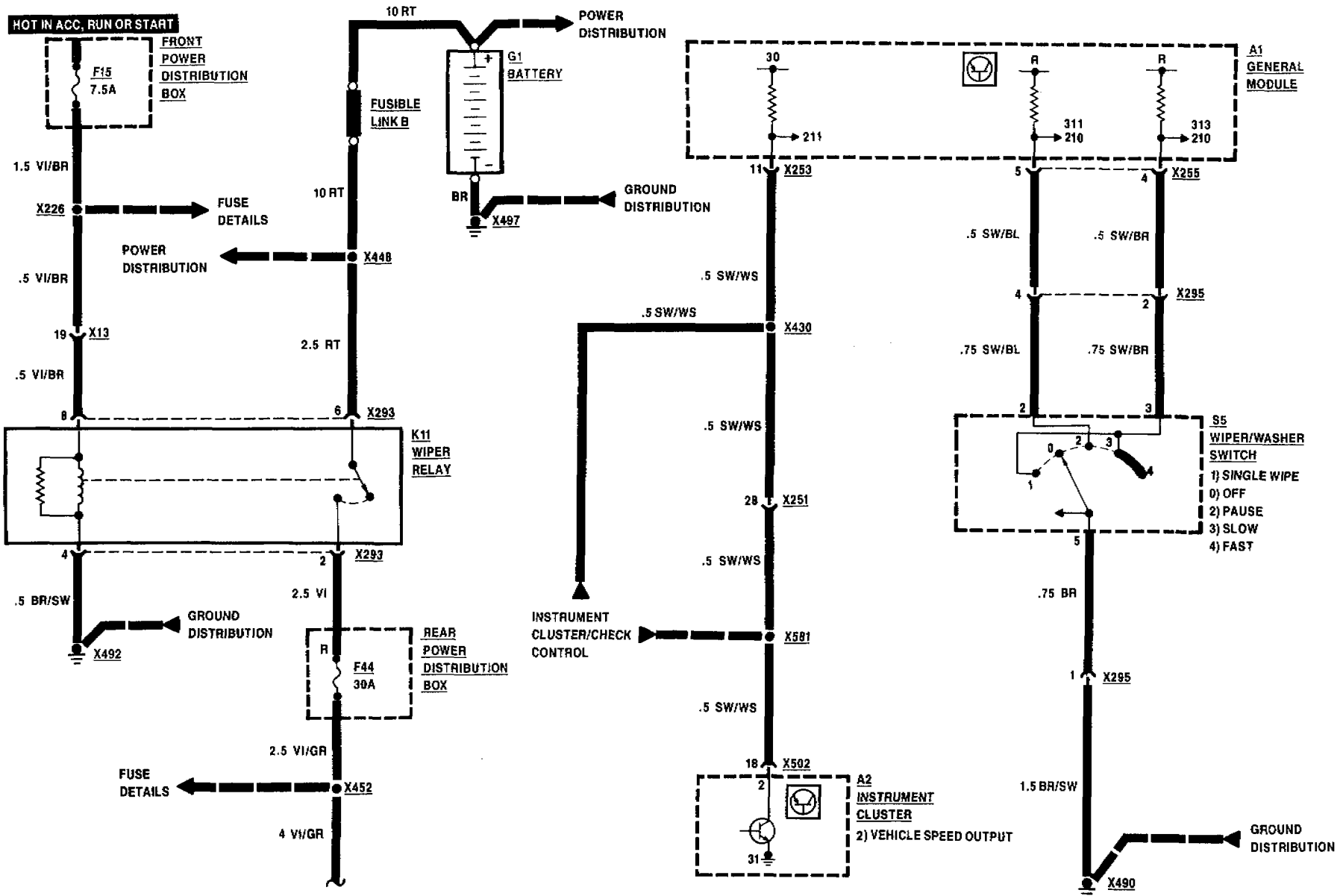

09/88

6161-00

1989

OUTPUT DETAILS

WIRE COLORS	
BL	BLUE
BR	BROWN
GE	YELLOW
GN	GREEN
GR	GRAY
OR	ORANGE
RS	PINK
RT	RED
SW	BLACK
VI	VIOLET
WS	WHITE

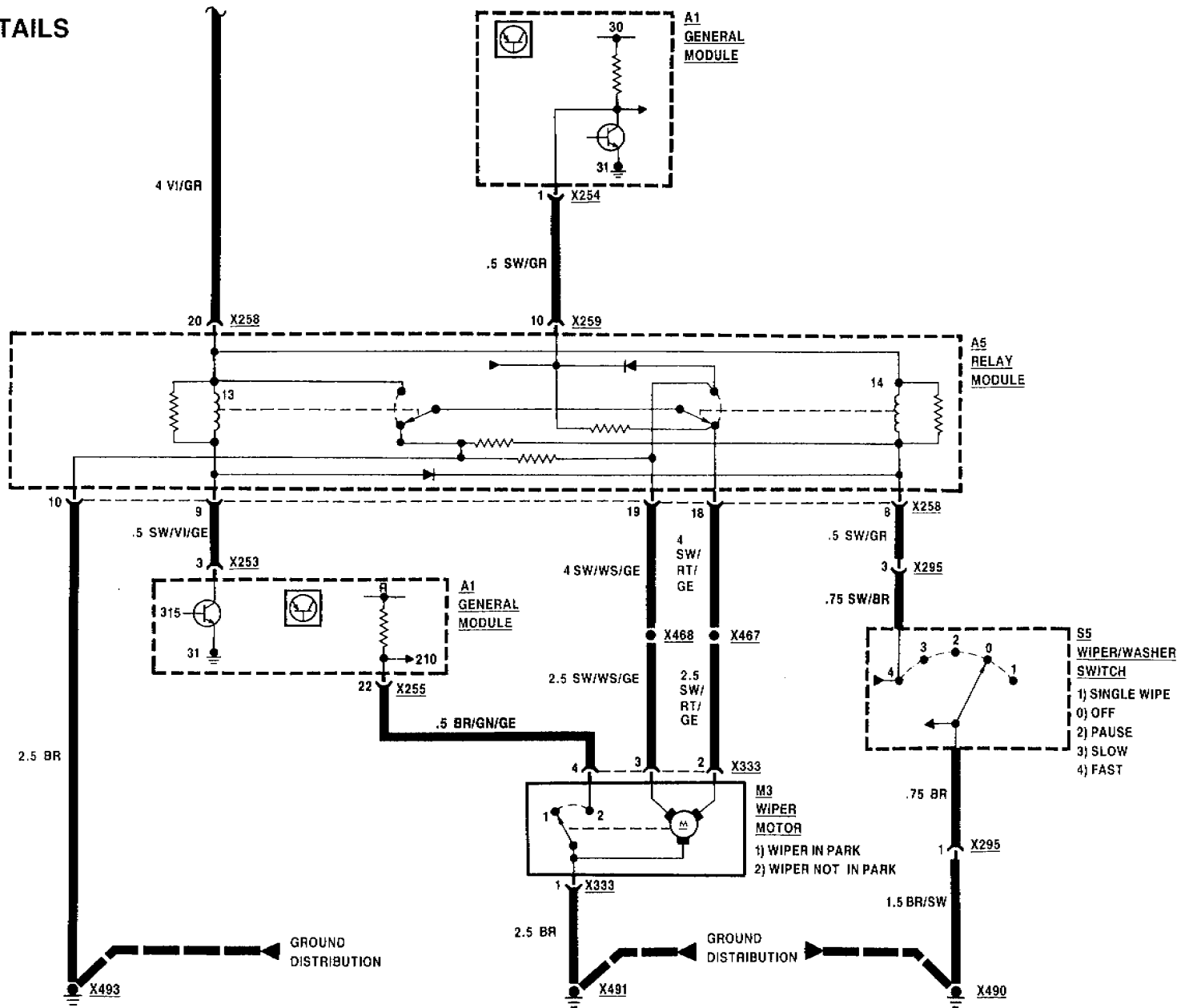



WINDSHIELD WASHER (ZKE)

INPUT DETAILS

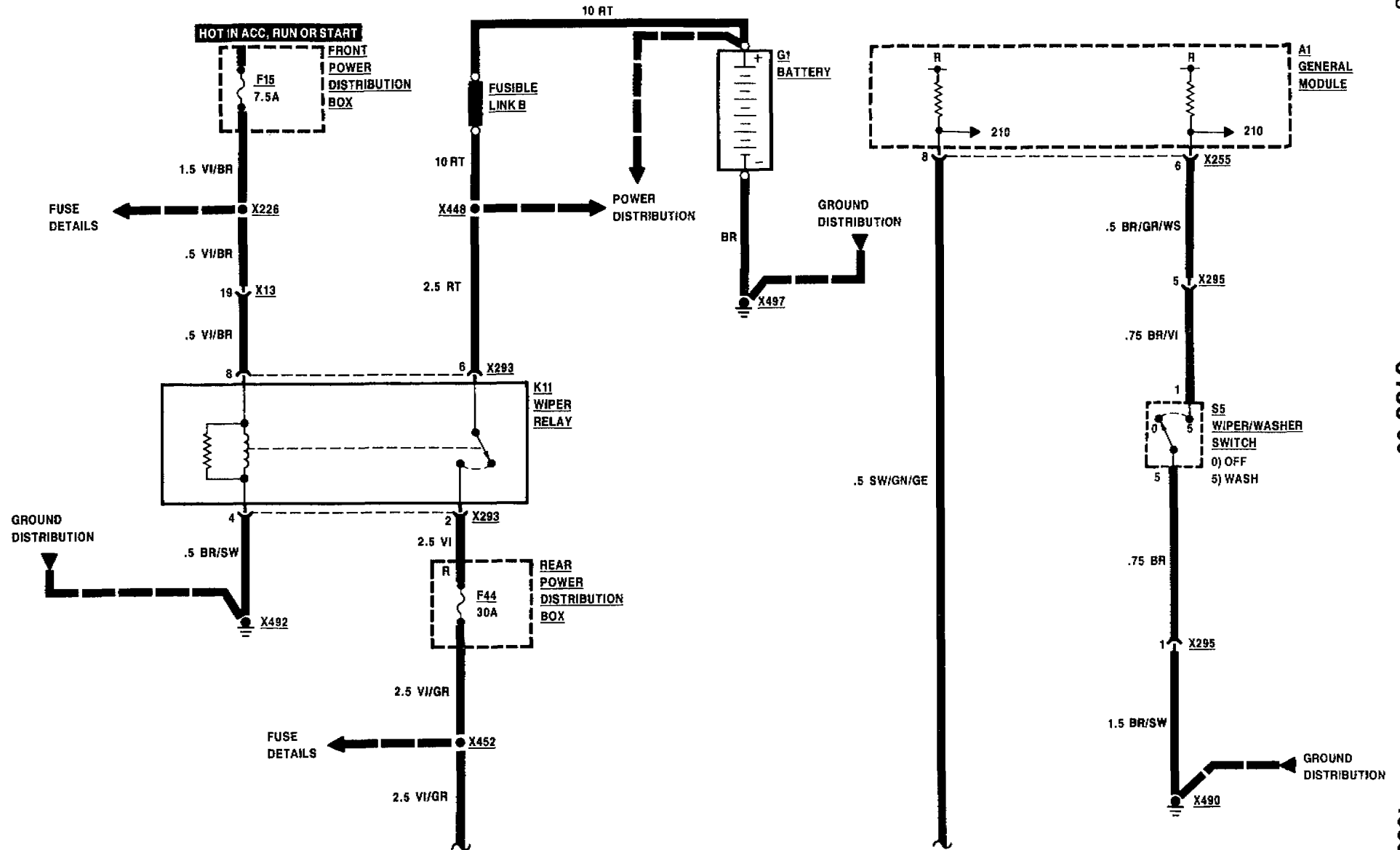

OUTPUT DETAILS

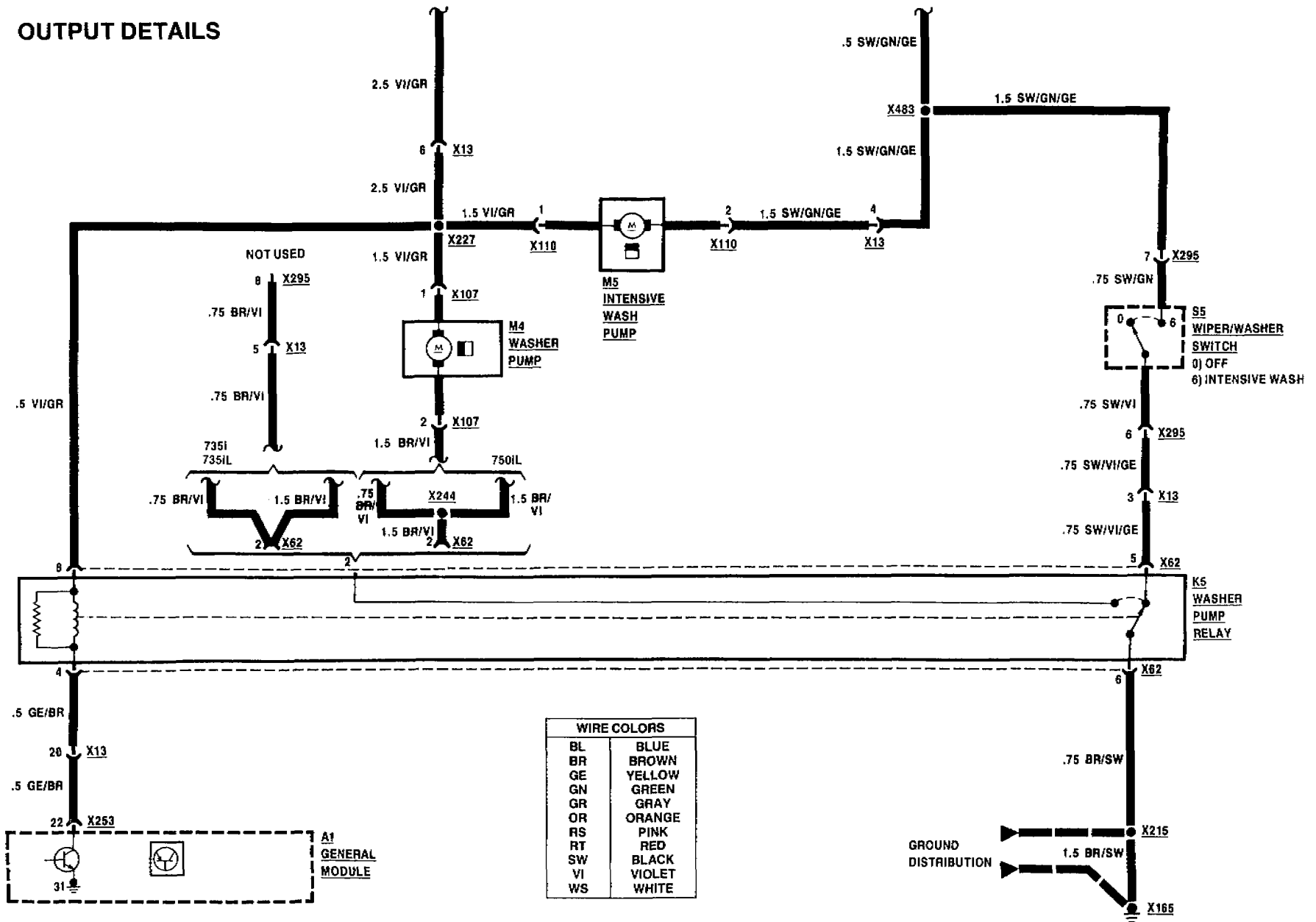



HEADLIGHT/FOG LIGHT WASHER (ZKE)

735iL, 750iL

INPUT DETAILS

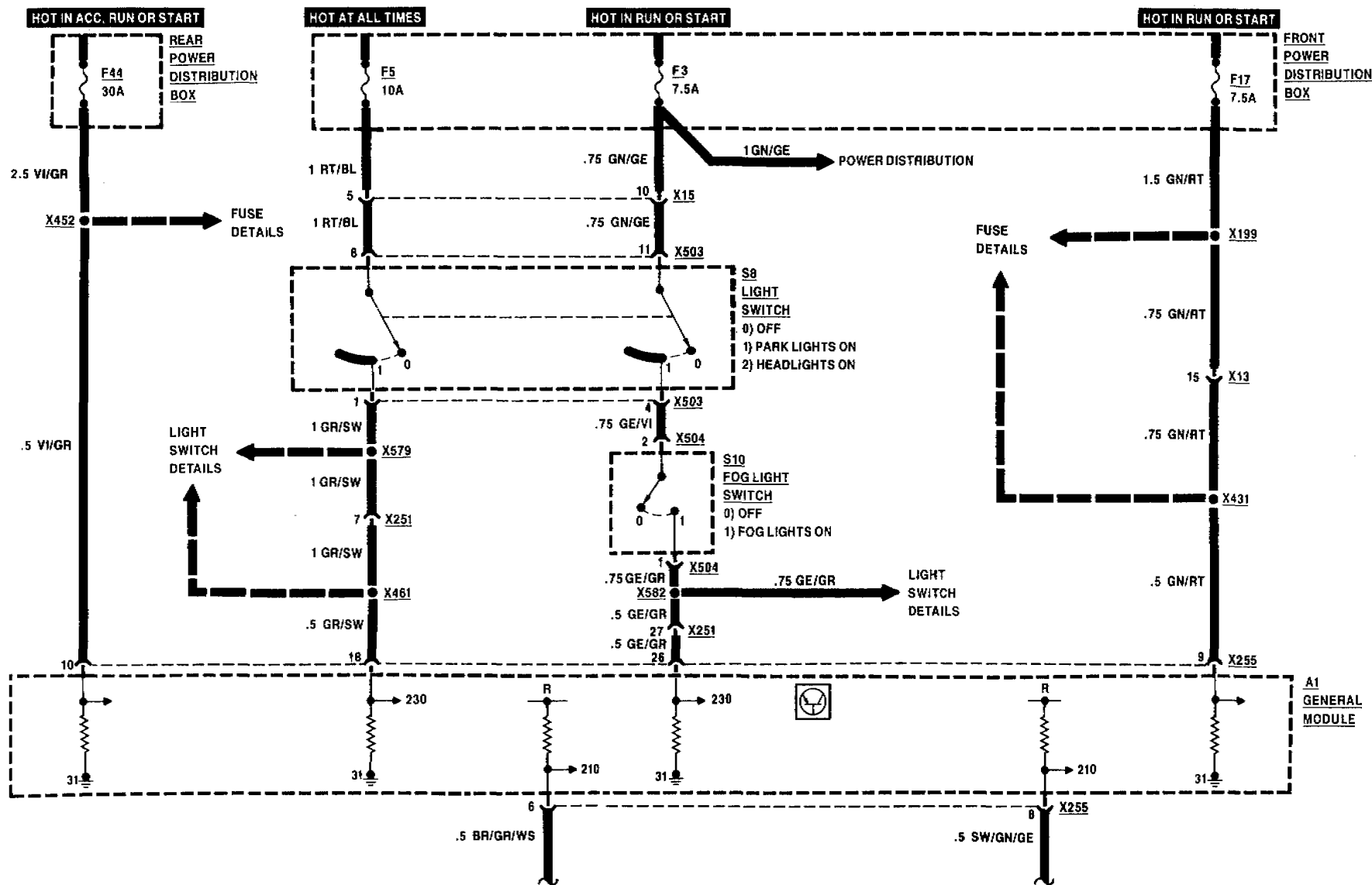

WIRE COLORS	
BL	BLUE
BR	BROWN
GE	YELLOW
GN	GREEN
GR	GRAY
OR	ORANGE
RS	PINK
RT	RED
SW	BLACK
VI	VIOLET
WS	WHITE

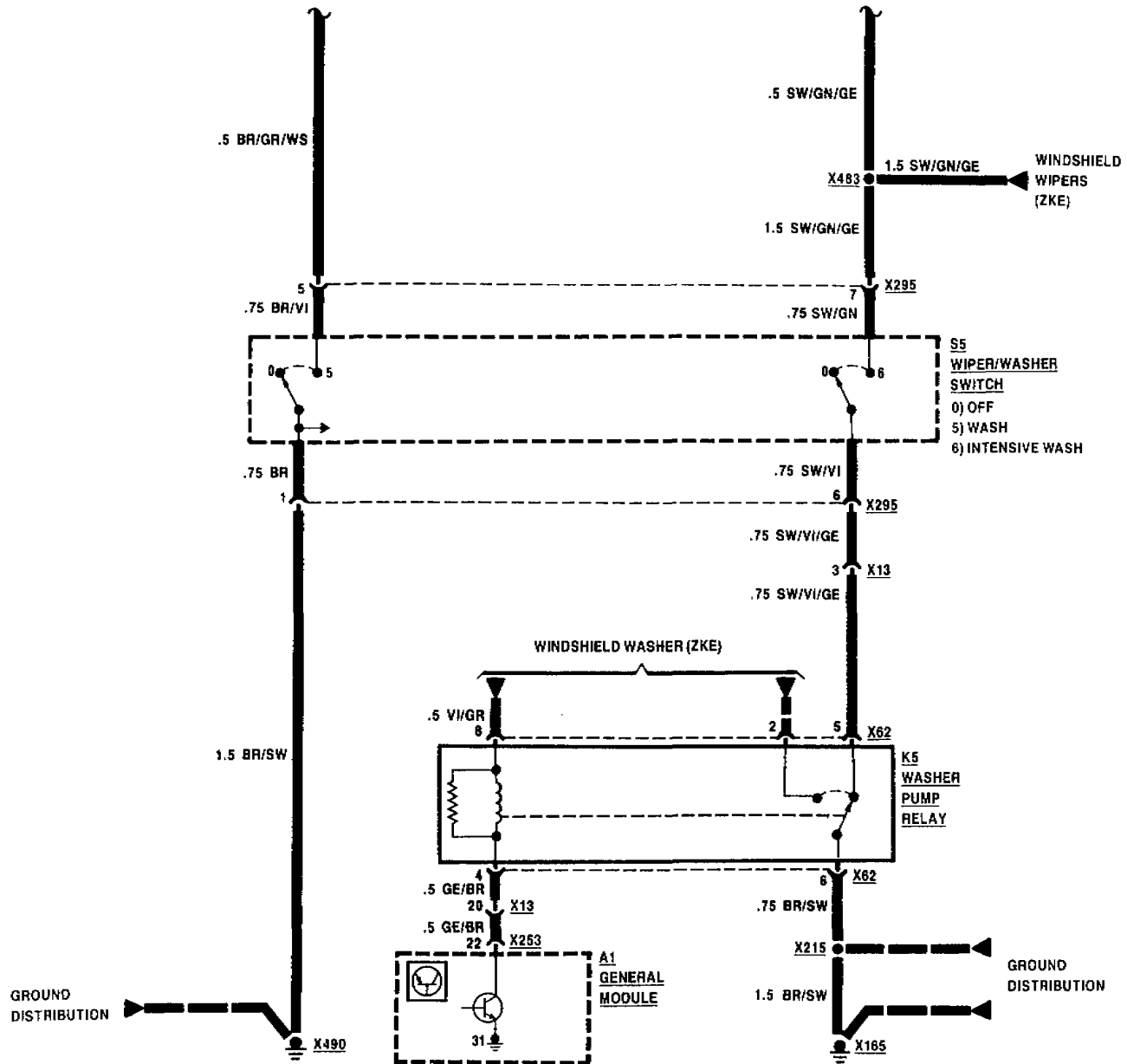



HEADLIGHT/FOG LIGHT WASHER (ZKE)

OUTPUT DETAILS

735iL, 750iL

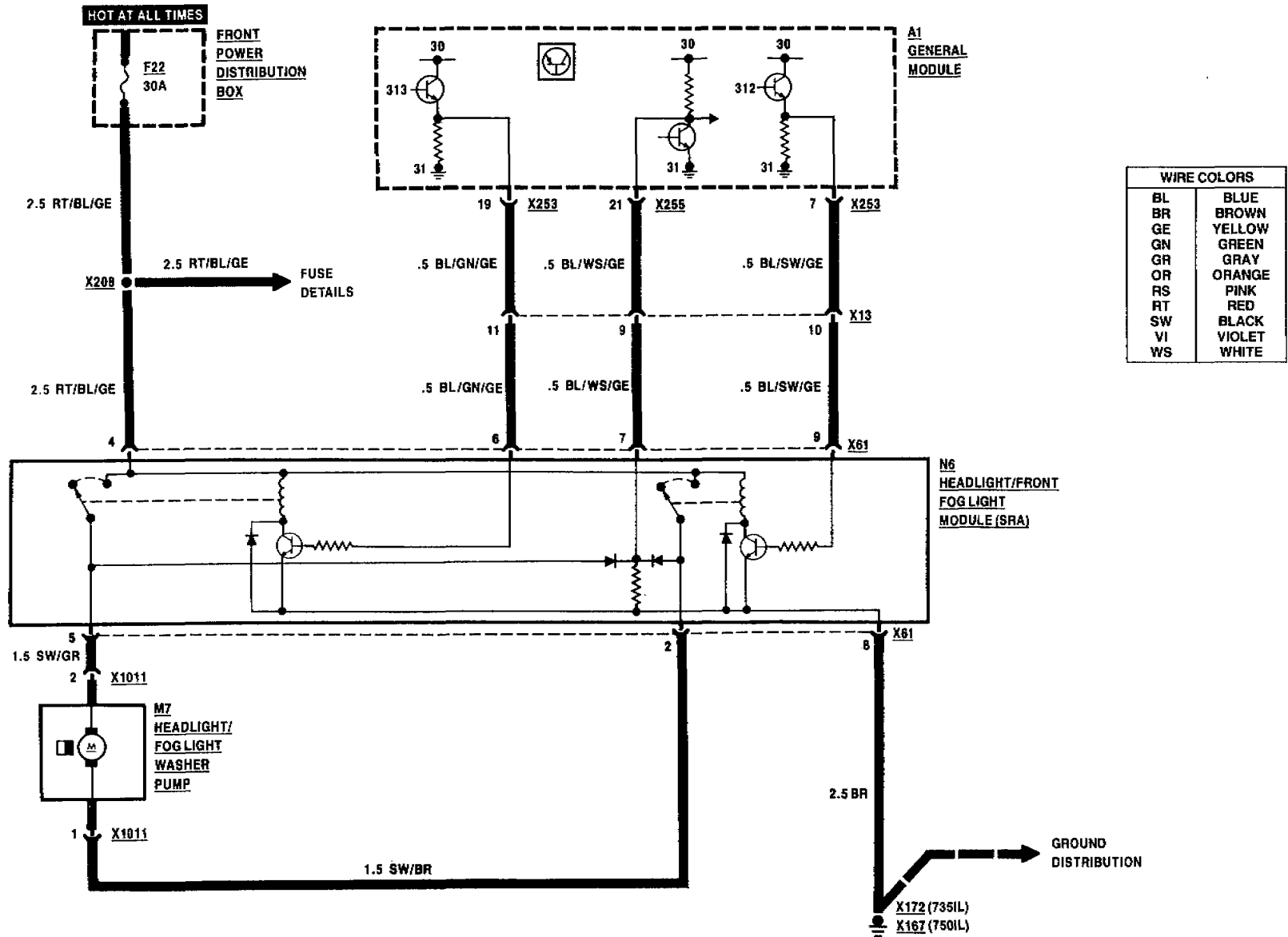



WINDSHIELD WIPER PRESSURE CONTROL (ZKE)

INPUT DETAILS

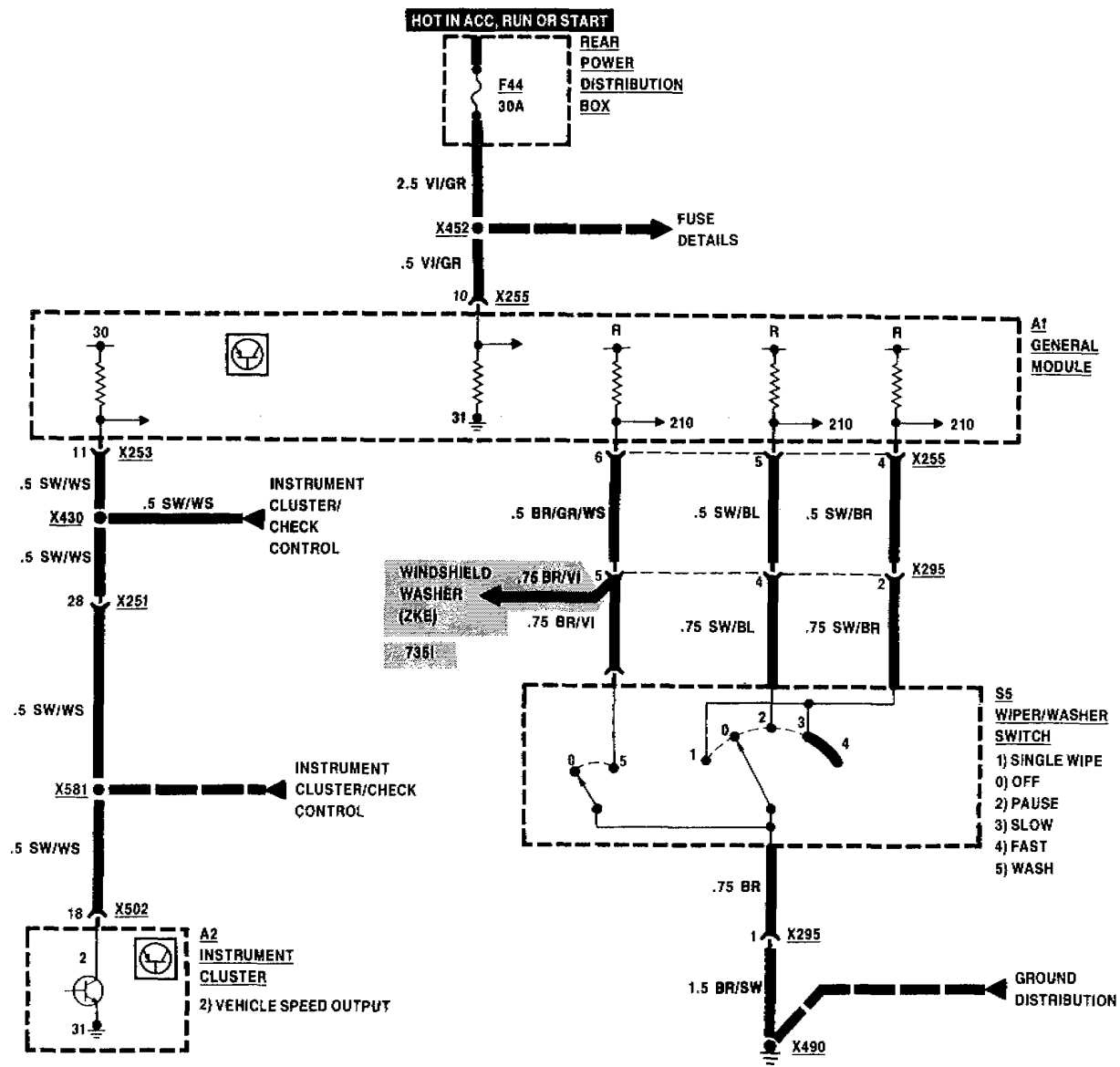

WIRE COLORS	
BL	BLUE
BR	BROWN
GE	YELLOW
GN	GREEN
GR	GRAY
OR	ORANGE
RS	PINK
RT	RED
SW	BLACK
VI	VIOLET
WS	WHITE



WINDSHIELD WIPER PRESSURE CONTROL (ZKE)

OUTPUT DETAILS

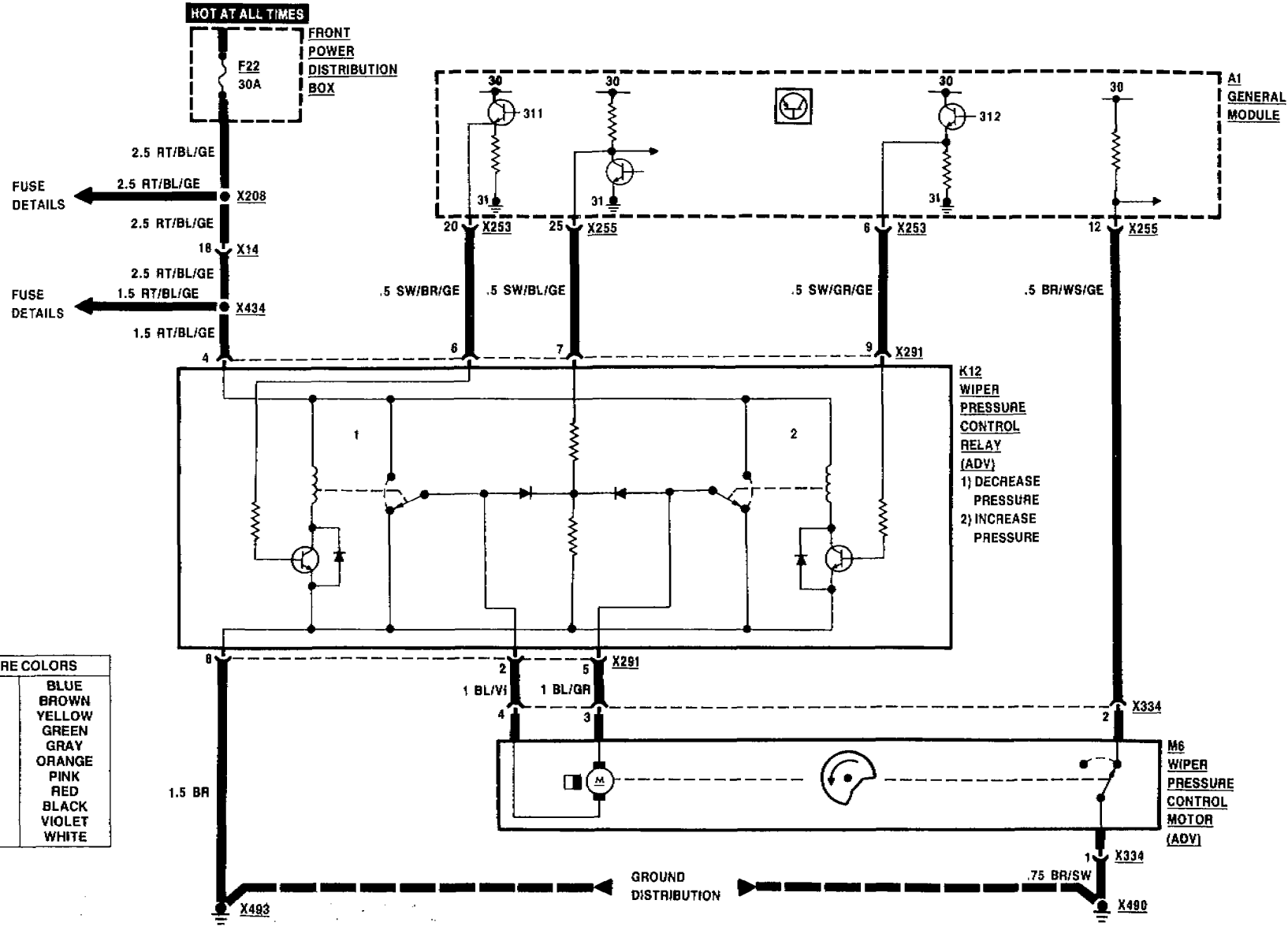

WIRE COLORS	
BL	BLUE
BR	BROWN
GE	YELLOW
GN	GREEN
GR	GRAY
OR	ORANGE
RS	PINK
RT	RED
SW	BLACK
VI	VIOLET
WS	WHITE



WINDSHIELD WASHER JET HEATERS

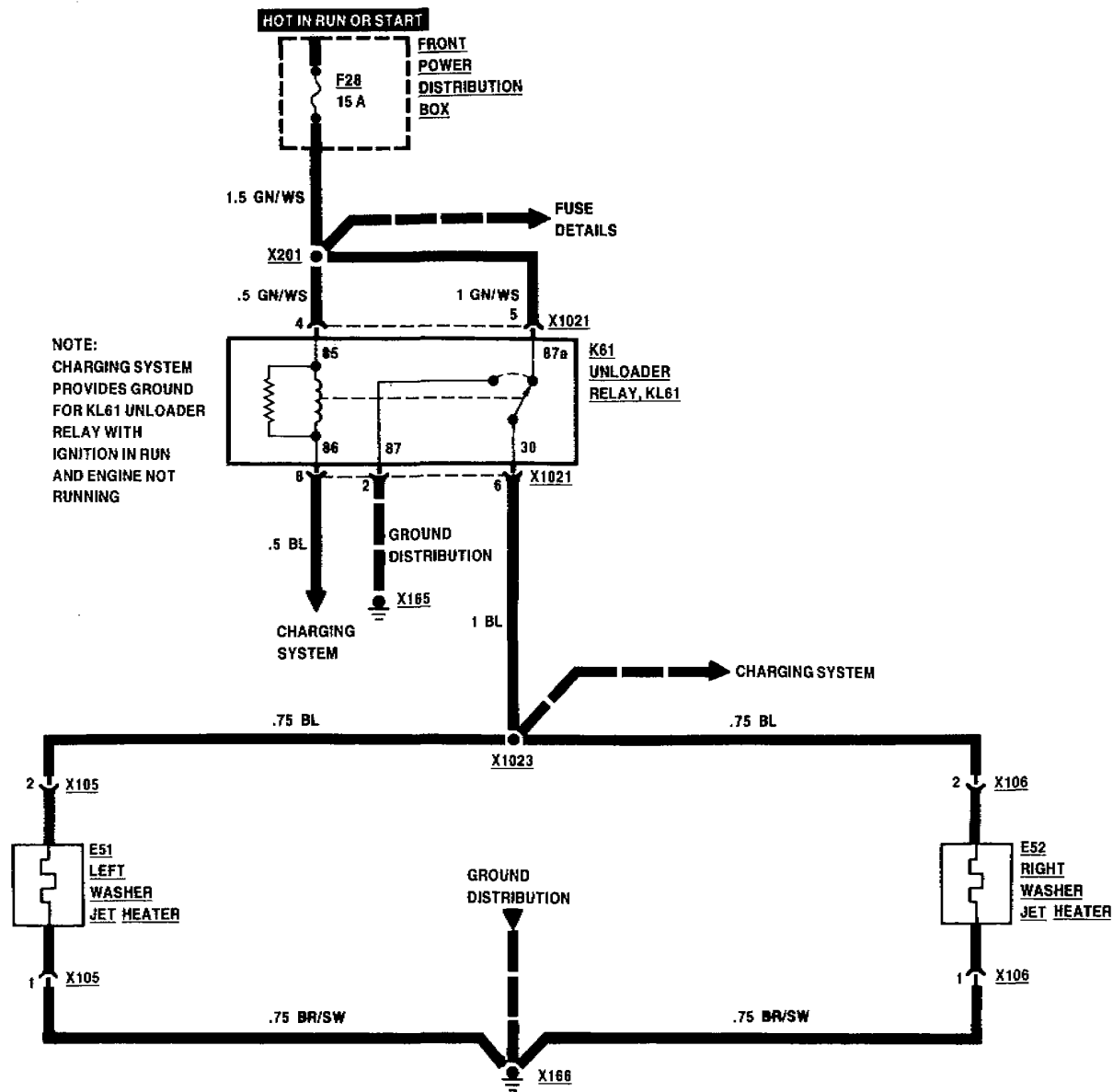

WIRE COLORS	
BL	BLUE
BR	BROWN
GE	YELLOW
GN	GREEN
GR	GRAY
OR	ORANGE
RS	PINK
RT	RED
SW	BLACK
VI	VIOLET
WS	WHITE



INSTRUMENT CLUSTER/CHECK CONTROL INDICATORS

WIRE COLORS	
BL	BLUE
BR	BROWN
GE	YELLOW
GN	GREEN
GR	GRAY
OR	ORANGE
RS	PINK
RT	RED
SW	BLACK
VI	VIOLET
WS	WHITE

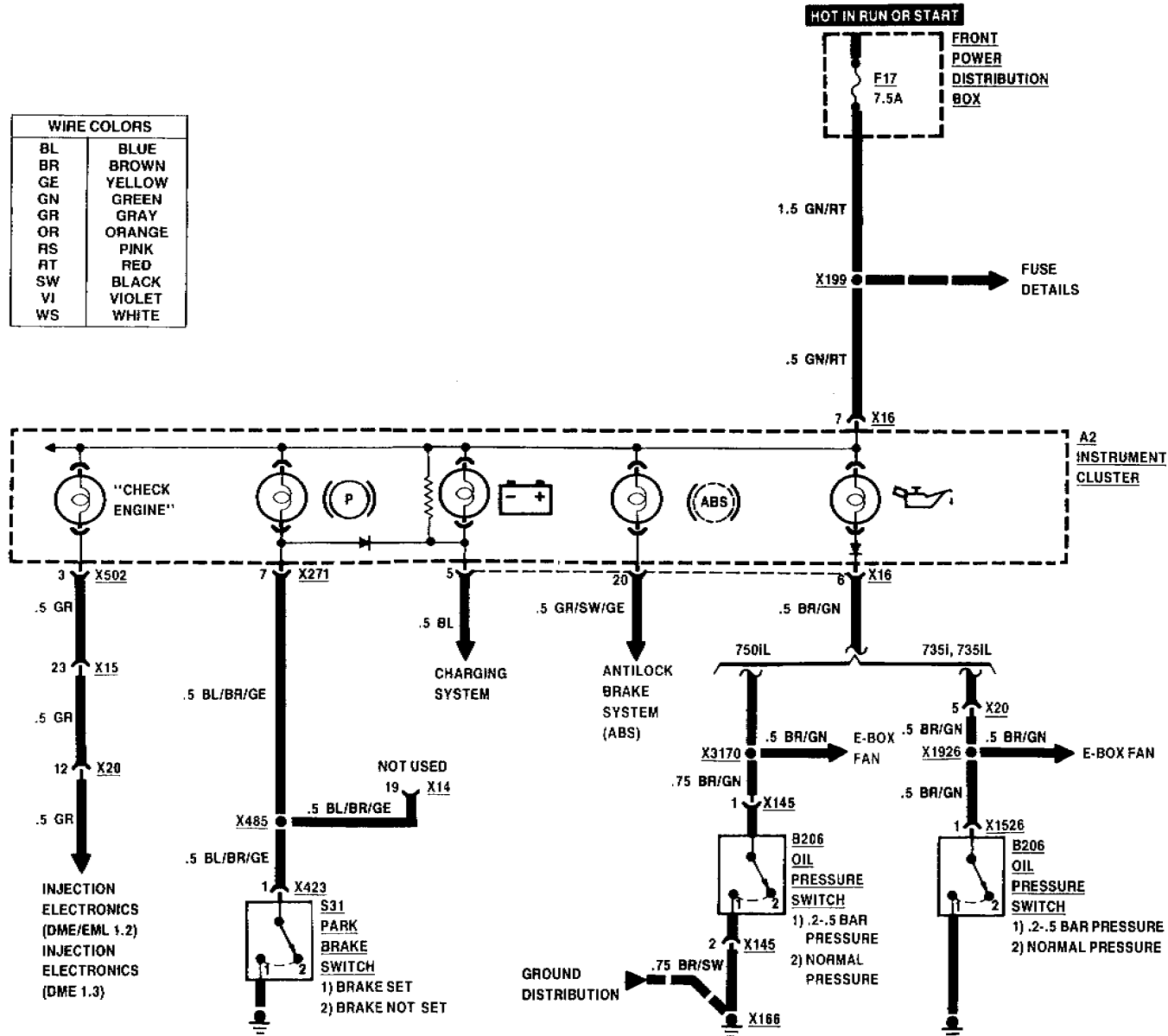



INSTRUMENT CLUSTER/CHECK CONTROL

INSTRUMENT CLUSTER INDICATORS

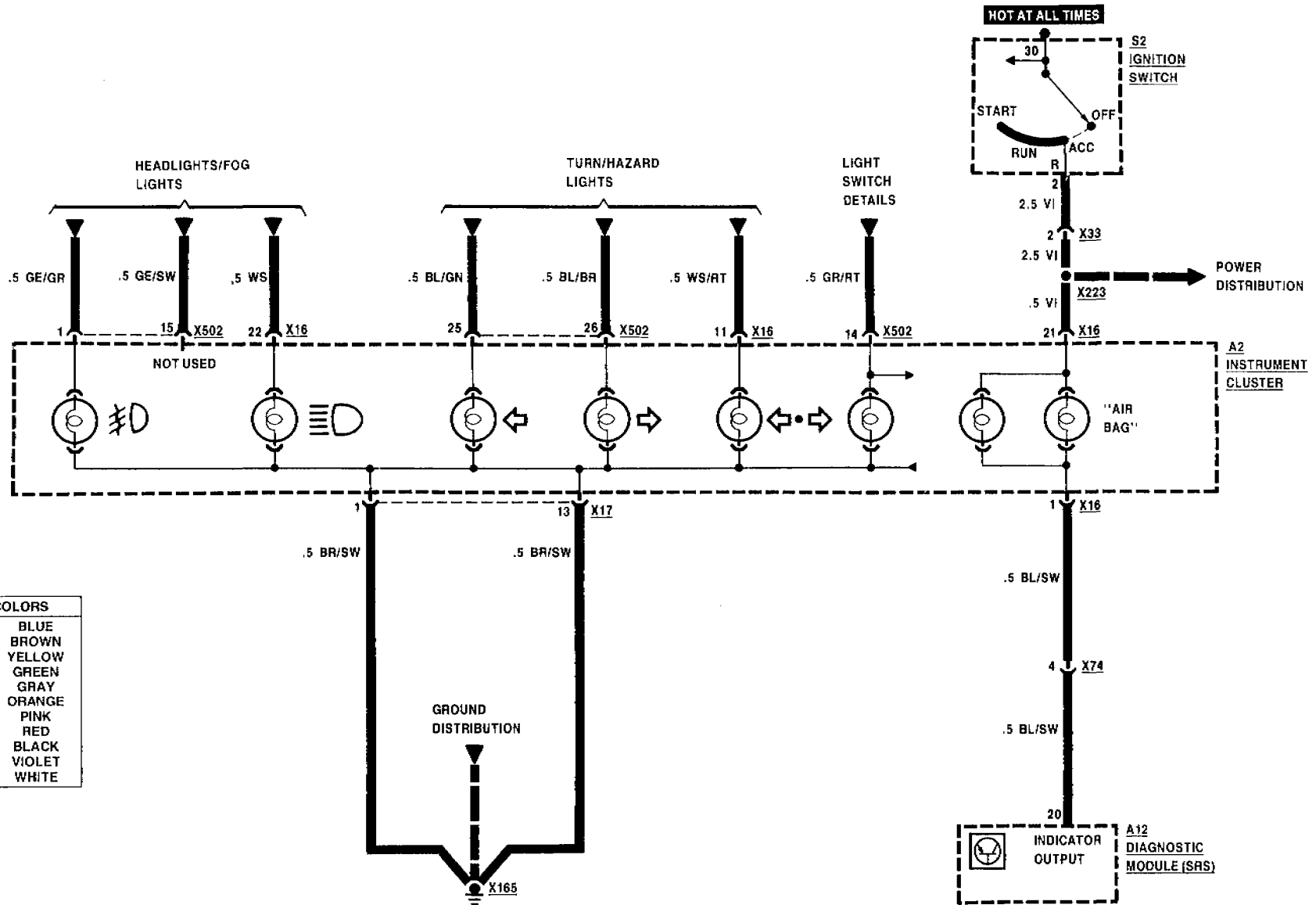

WIRE COLORS	
BL	BLUE
BR	BROWN
GE	YELLOW
GN	GREEN
GR	GRAY
OR	ORANGE
RS	PINK
RT	RED
SW	BLACK
VI	VIOLET
WS	WHITE



INSTRUMENT CLUSTER/CHECK CONTROL INDICATORS

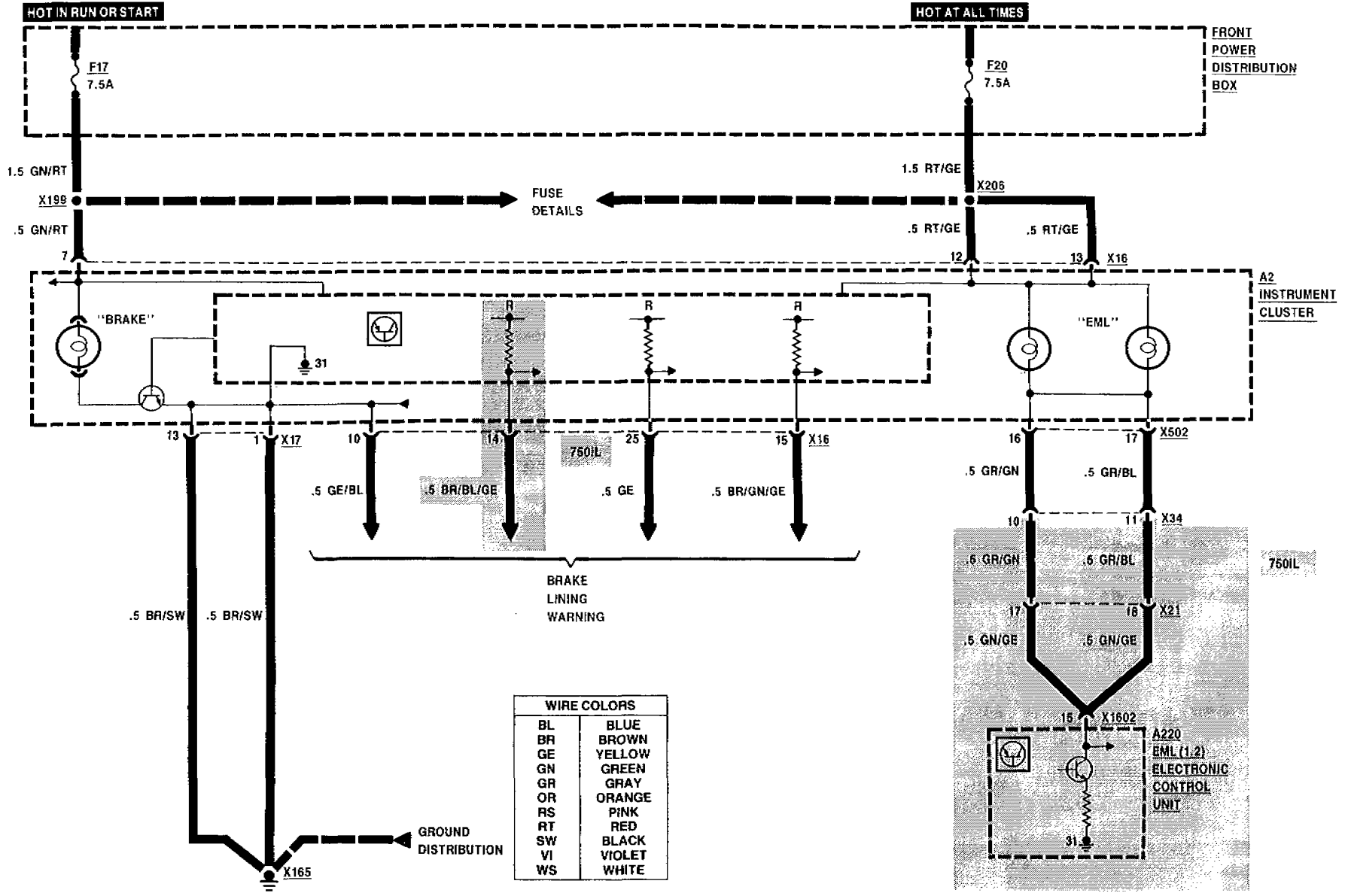



INSTRUMENT CLUSTER/CHECK CONTROL

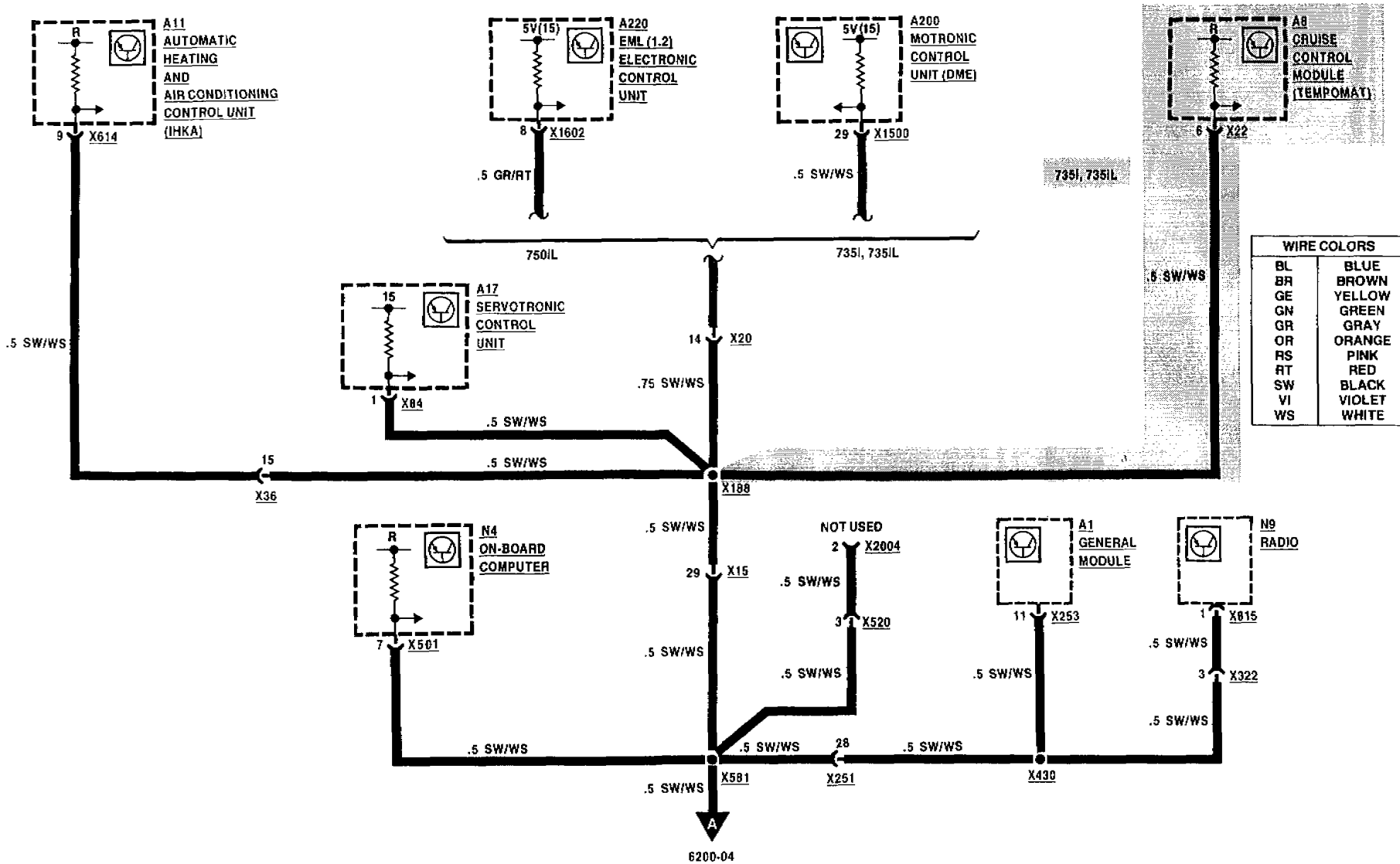



INSTRUMENT CLUSTER/CHECK CONTROL

INSTRUMENT CLUSTER GAUGES

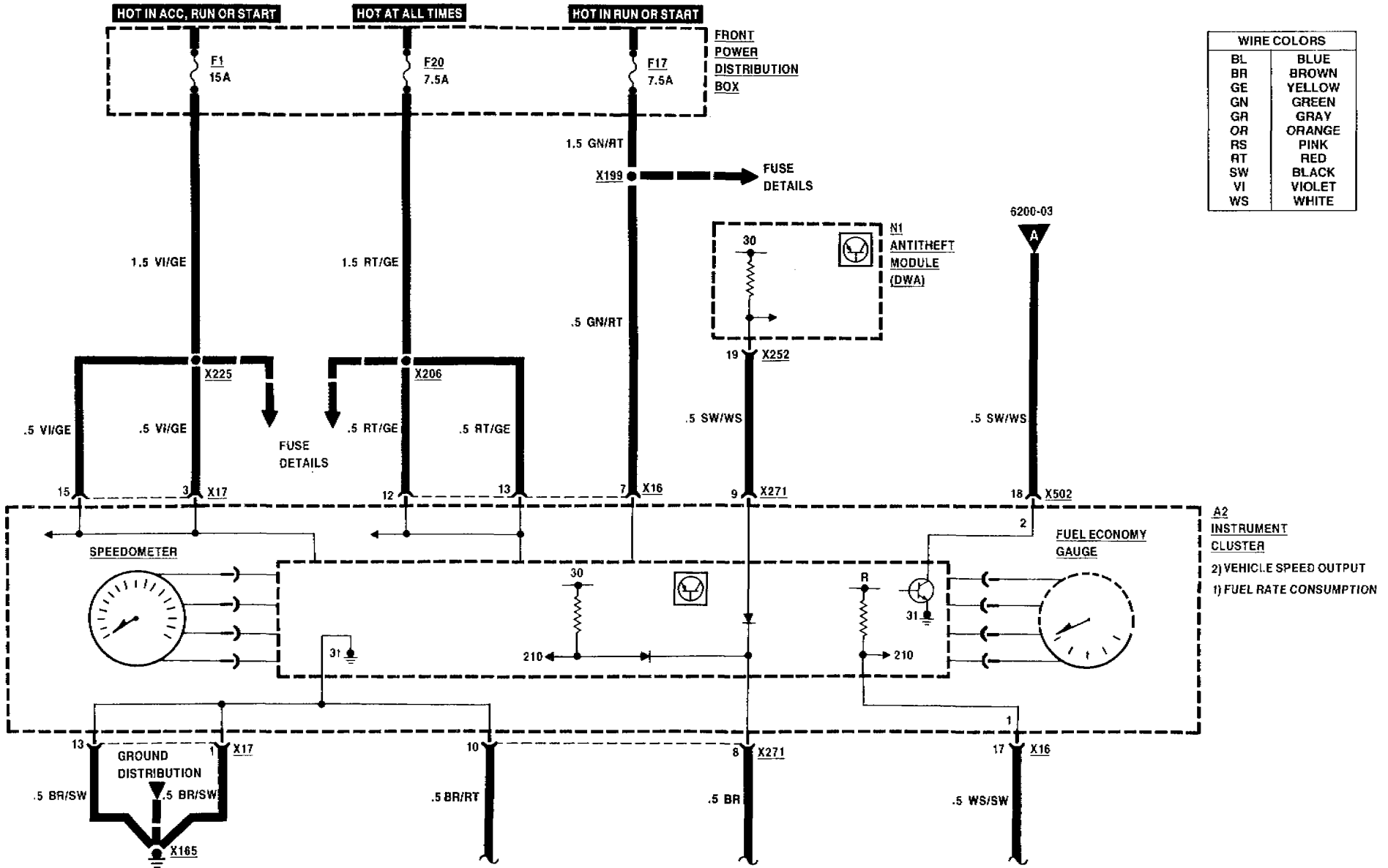

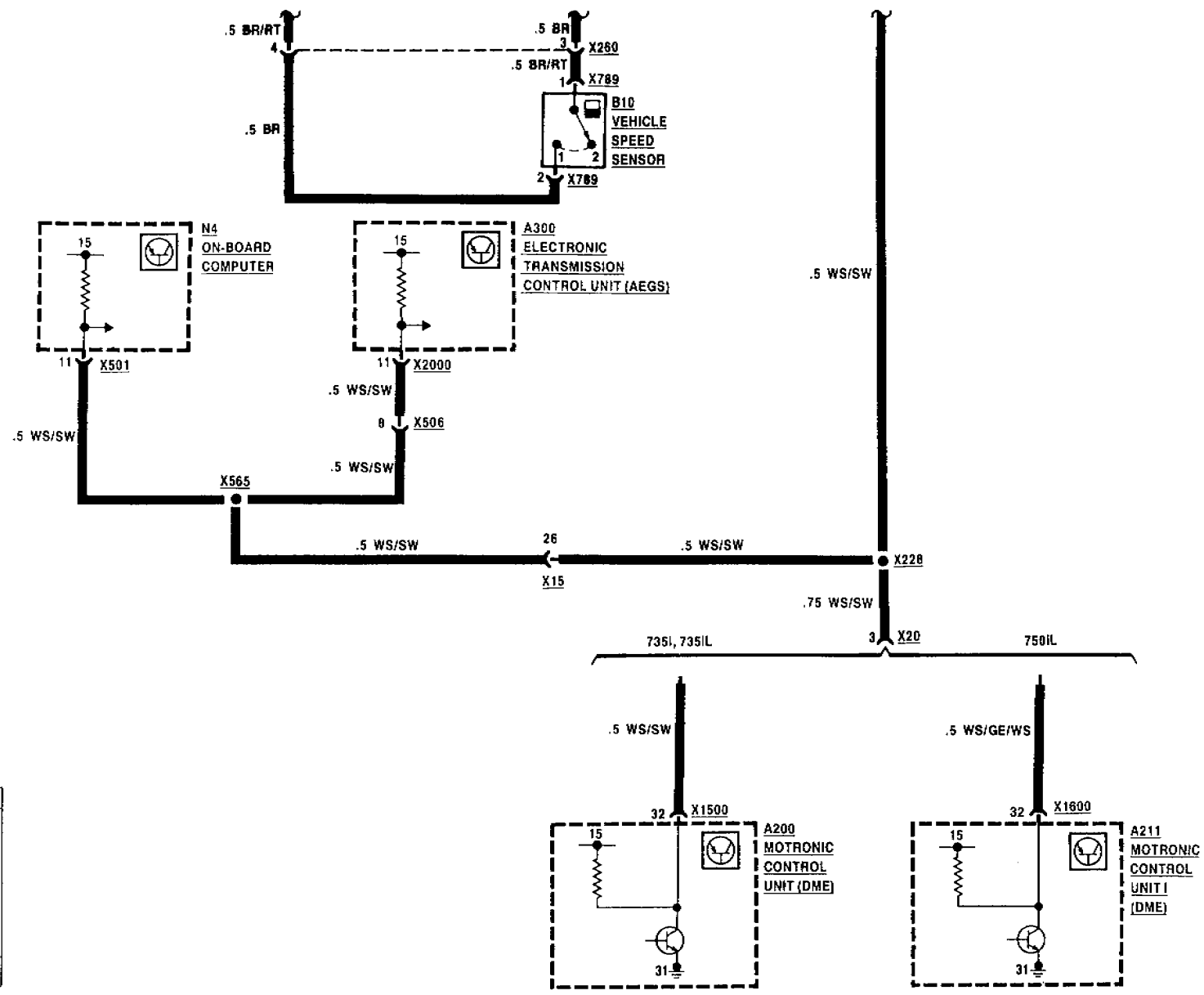

WIRE COLORS	
BL	BLUE
BR	BROWN
GE	YELLOW
GN	GREEN
GR	GRAY
OR	ORANGE
RS	PINK
RT	RED
SW	BLACK
VI	VIOLET
WS	WHITE



INSTRUMENT CLUSTER/CHECK CONTROL

INSTRUMENT CLUSTER GAUGES

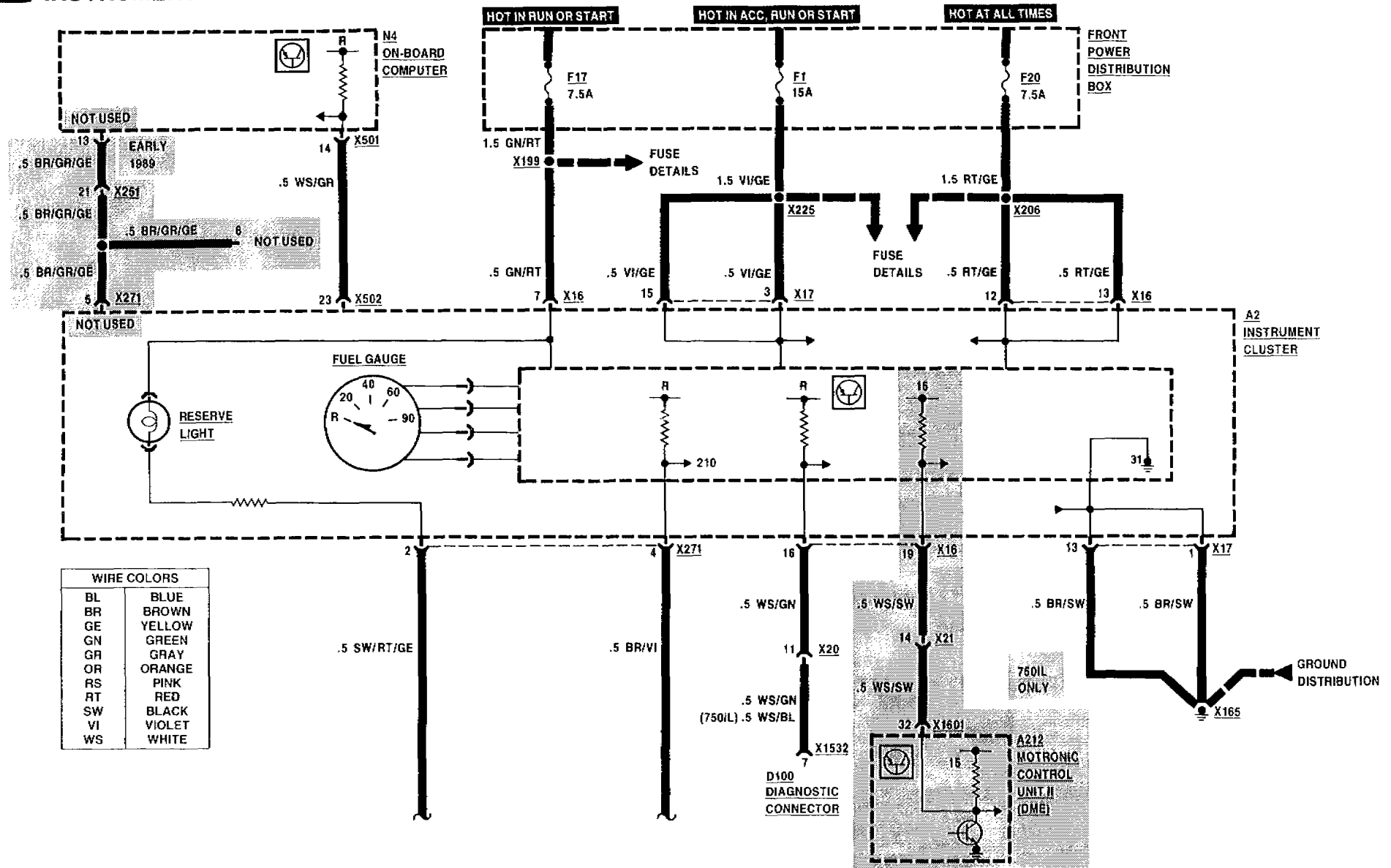

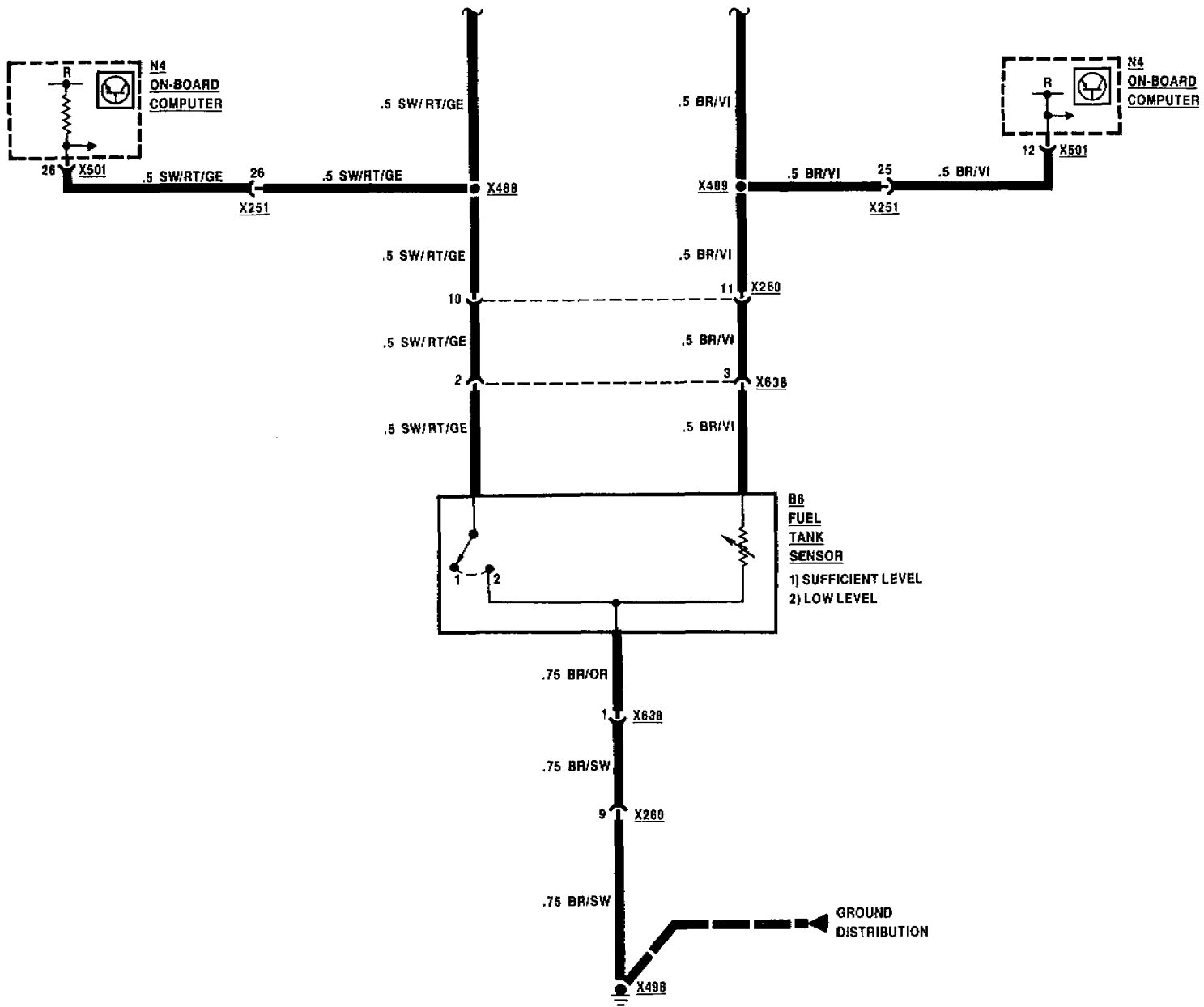



INSTRUMENT CLUSTER/CHECK CONTROL GAUGES

WIRE COLORS	
BL	BLUE
BR	BROWN
GE	YELLOW
GN	GREEN
GR	GRAY
OR	ORANGE
RS	PINK
RT	RED
SW	BLACK
VI	VIOLET
WS	WHITE

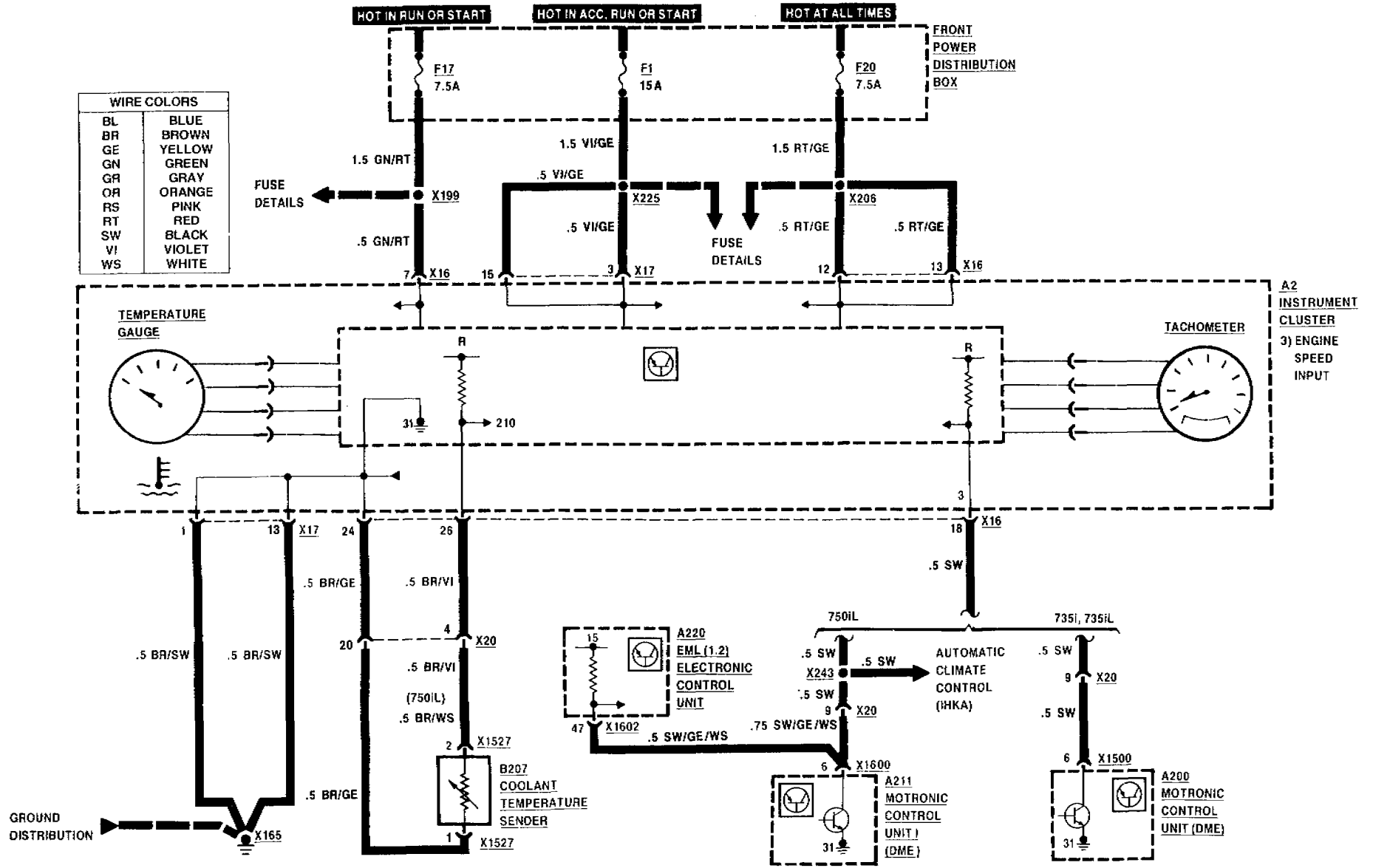



INSTRUMENT CLUSTER/CHECK CONTROL

GEAR INDICATOR

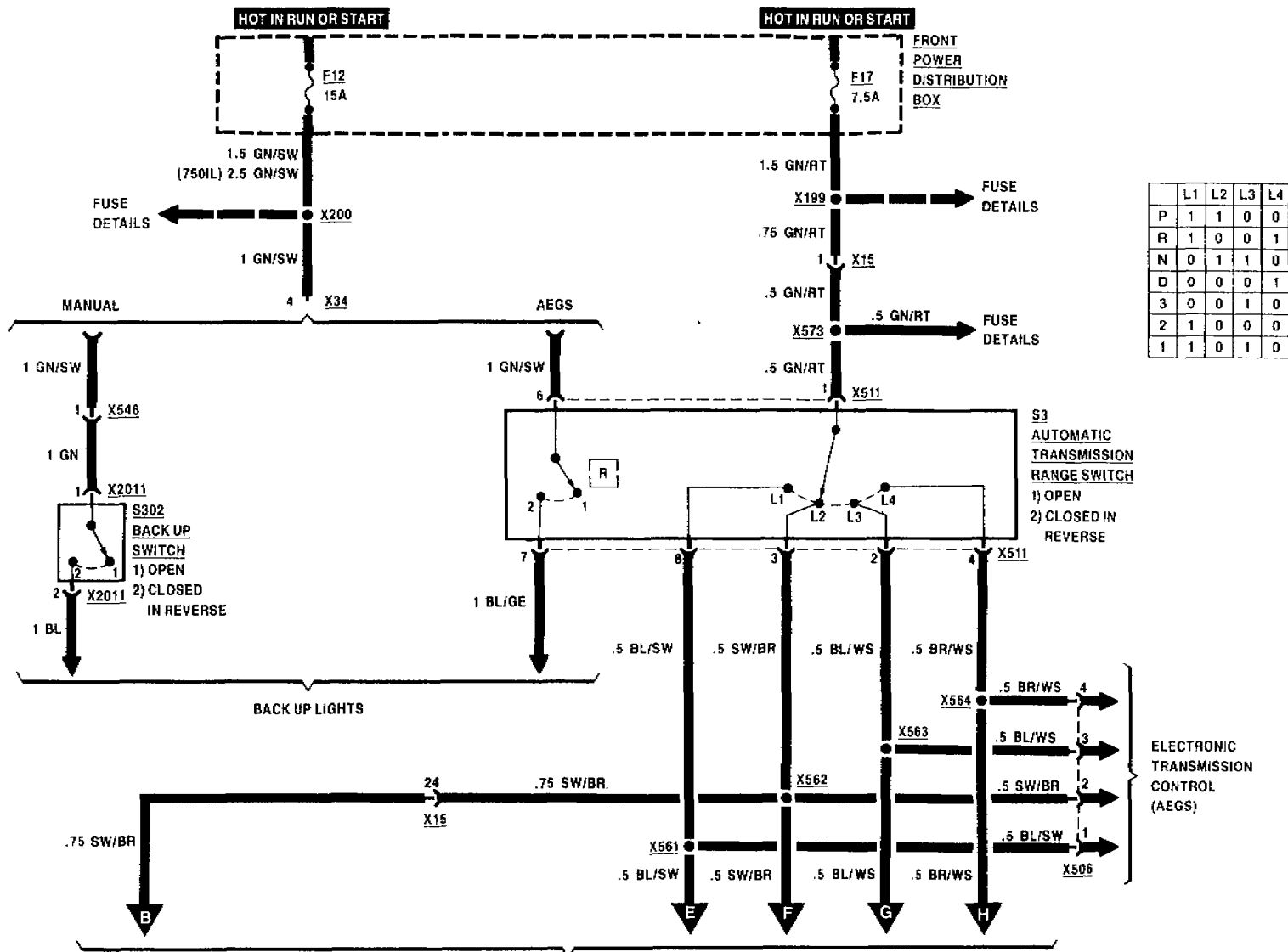



INSTRUMENT CLUSTER/CHECK CONTROL GEAR INDICATOR

6200-09

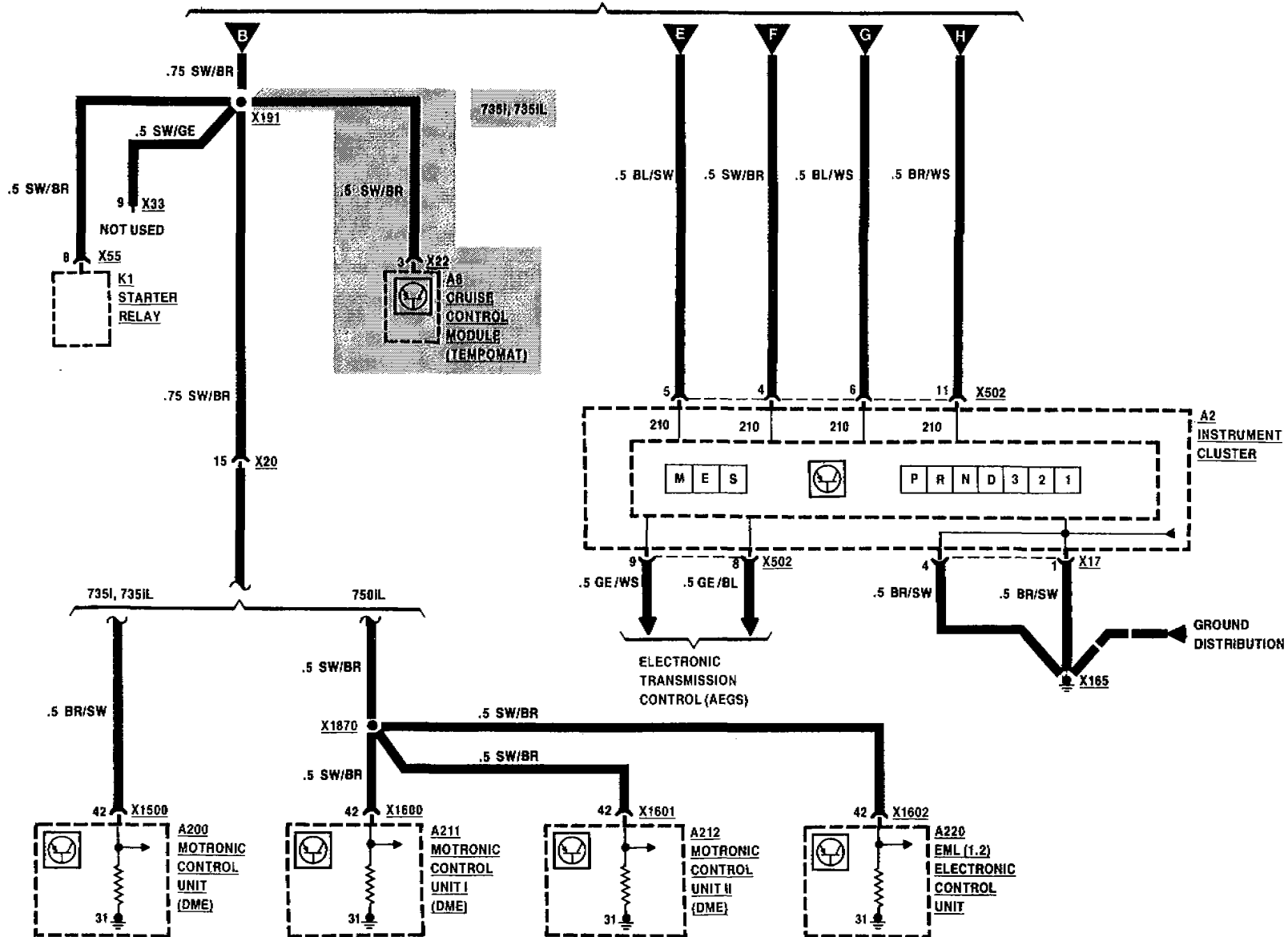

09/88

6200-10

1989



INSTRUMENT CLUSTER/CHECK CONTROL

CHECK CONTROL

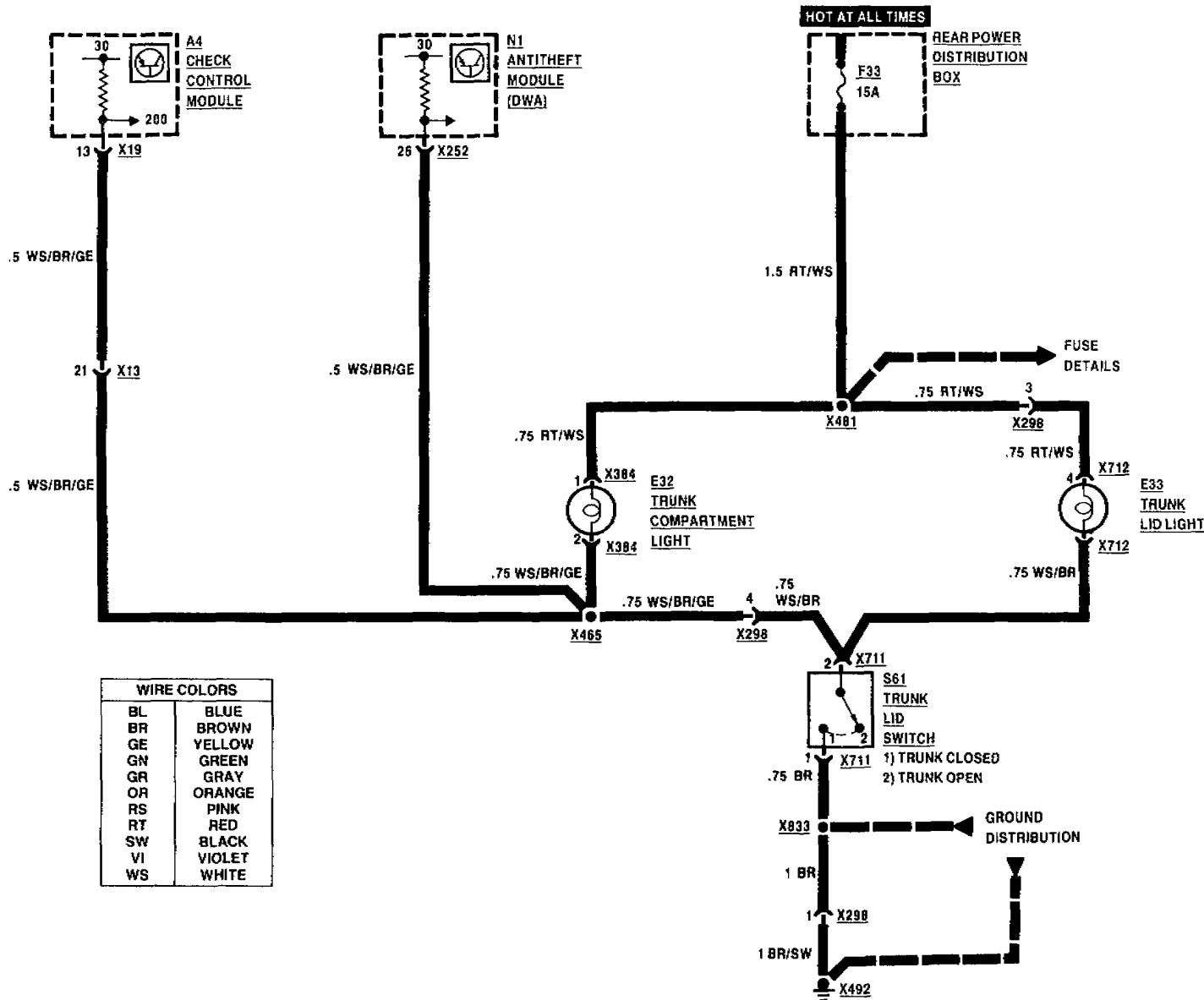



INSTRUMENT CLUSTER/CHECK CONTROL

CHECK CONTROL

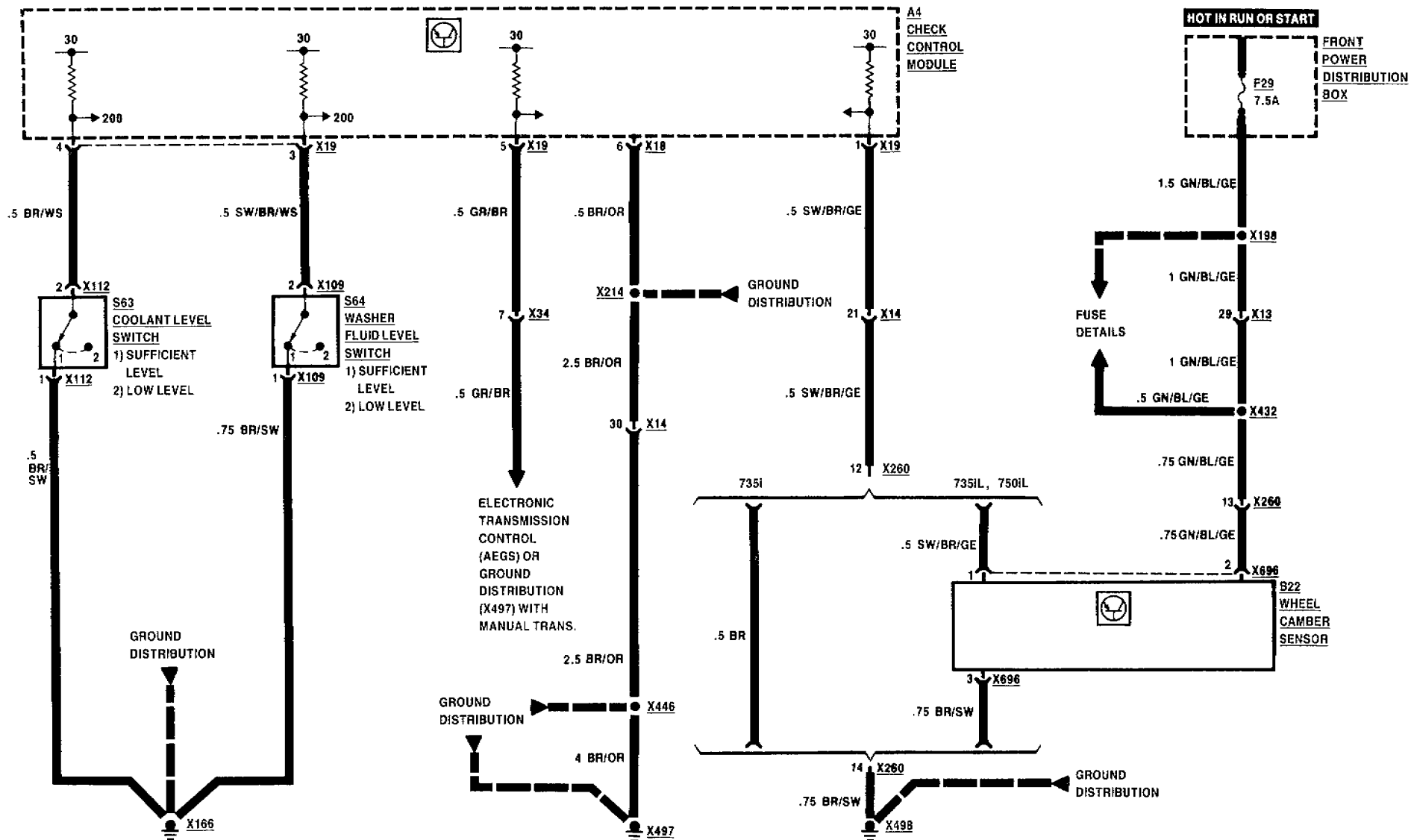



INSTRUMENT CLUSTER/CHECK CONTROL

CHECK CONTROL

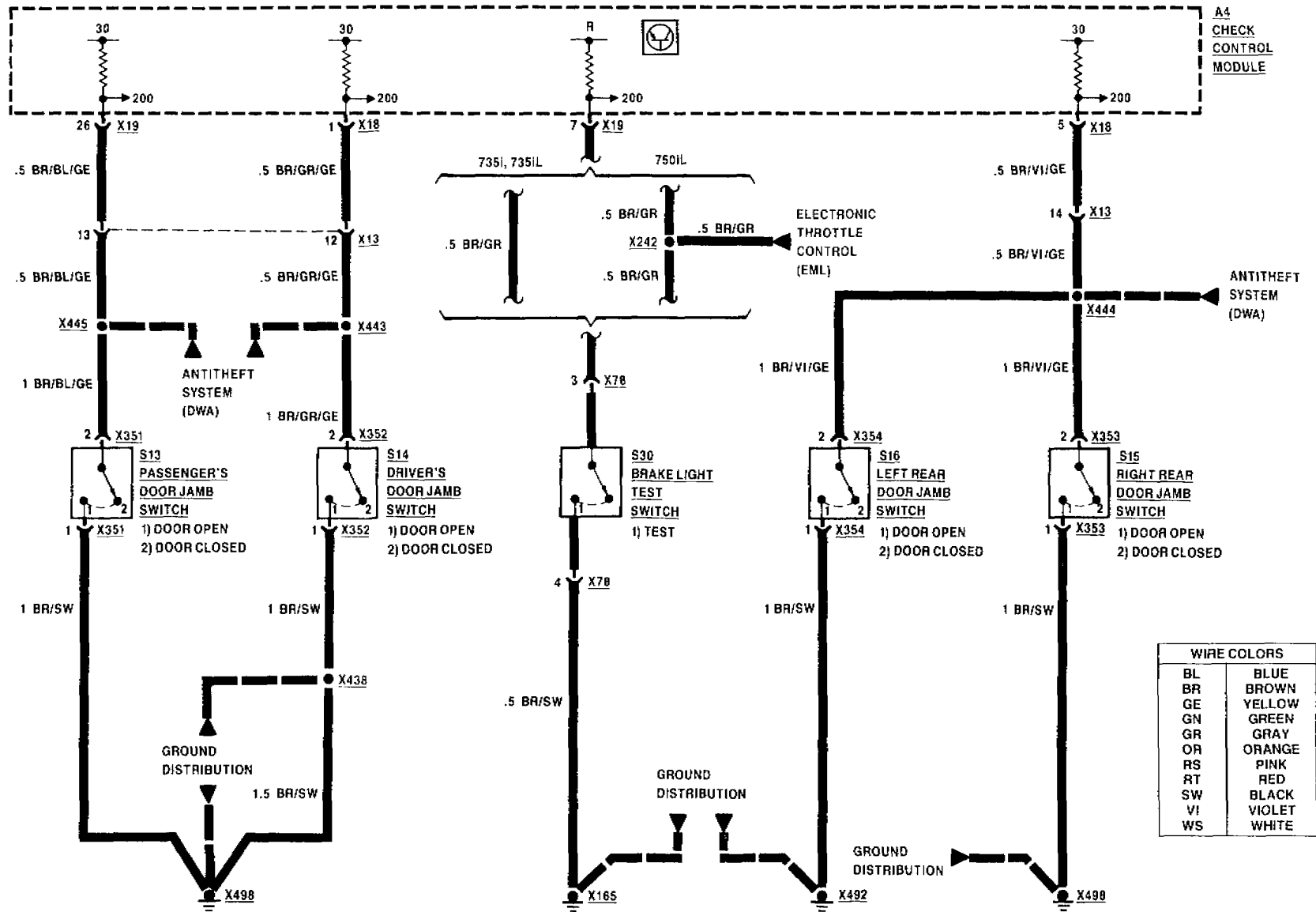



INSTRUMENT CLUSTER/CHECK CONTROL

CHECK CONTROL

WIRE COLORS	
BL	BLUE
BR	BROWN
GE	YELLOW
GN	GREEN
GR	GRAY
OR	ORANGE
RS	PINK
RT	RED
SW	BLACK
VI	VIOLET
WS	WHITE

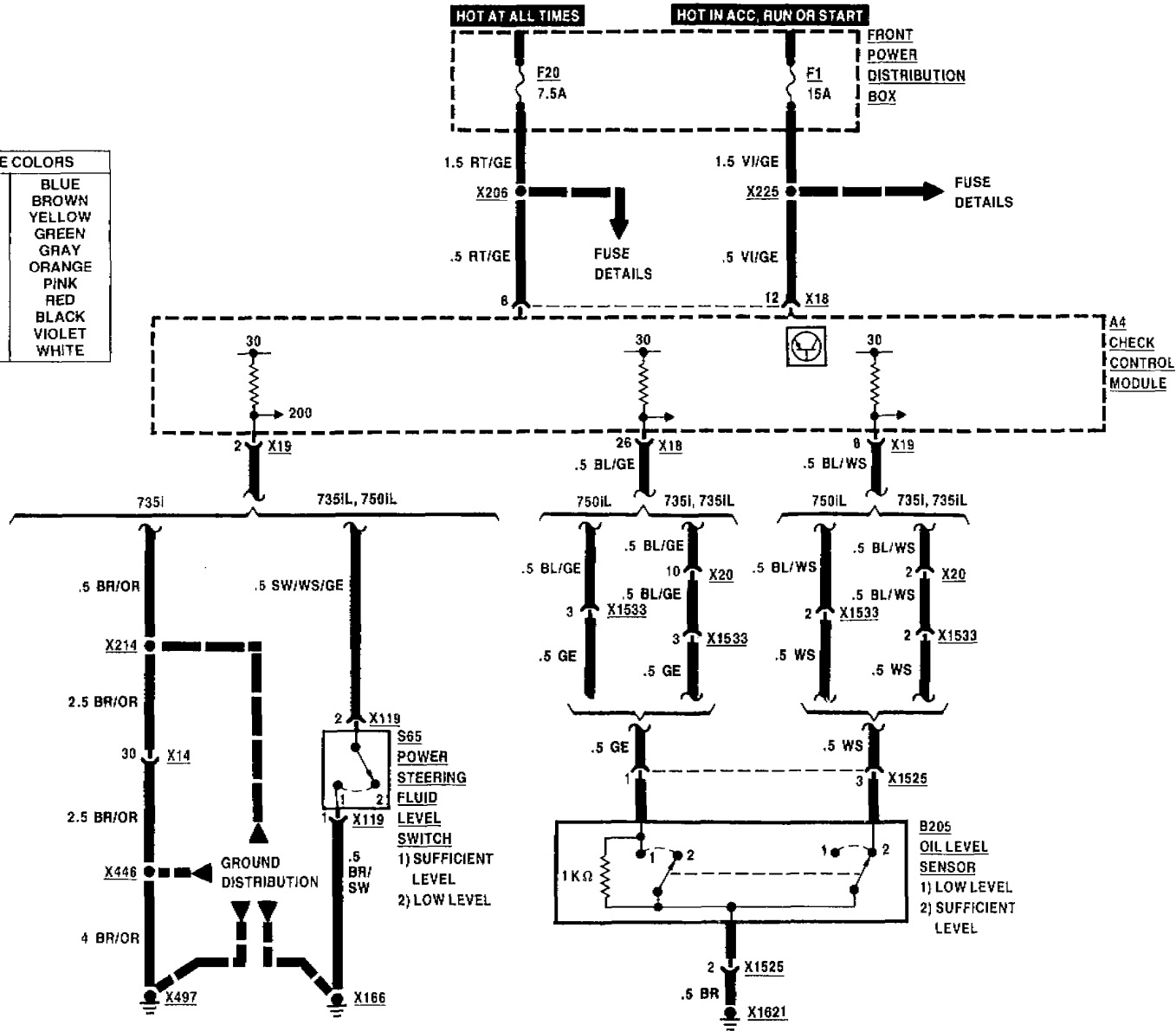

INSTRUMENT CLUSTER/CHECK CONTROL DATA LINK

HOT IN RUN OR START HOT IN AGC, RUN OR START HOT AT ALL TIMES

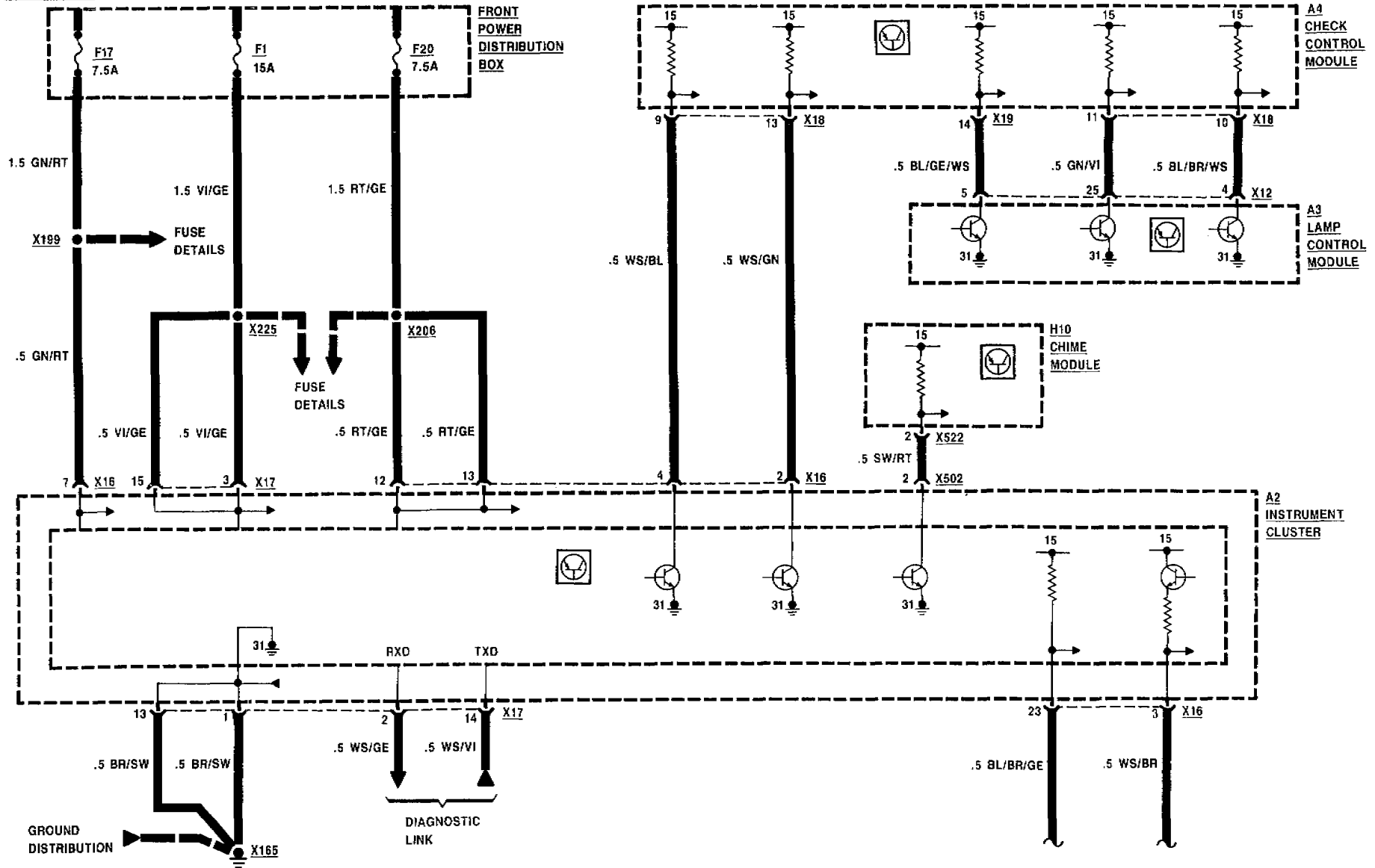

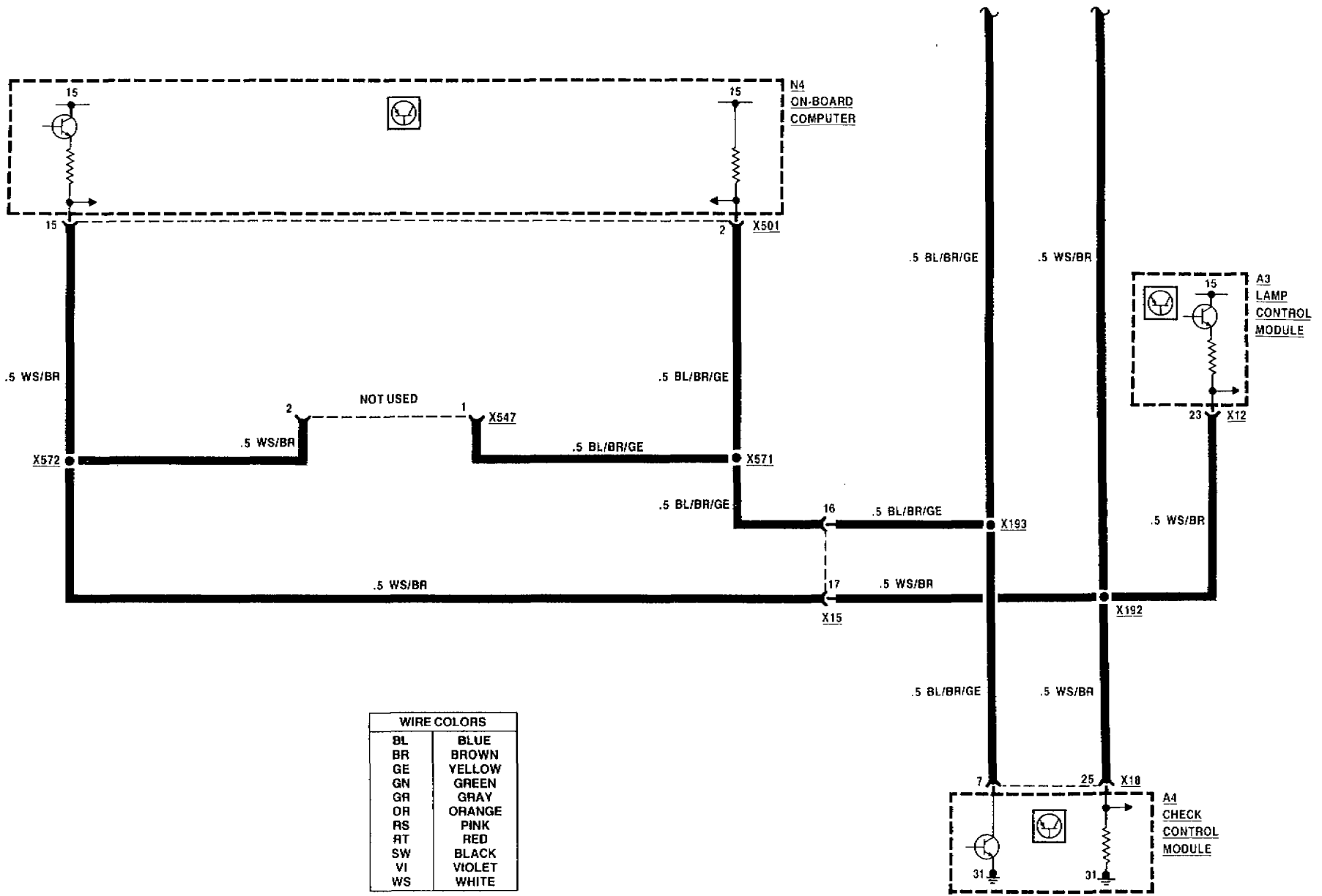

WIRE COLORS	
BL	BLUE
BR	BROWN
GE	YELLOW
GN	GREEN
GR	GRAY
OR	ORANGE
RS	PINK
RT	RED
SW	BLACK
VI	VIOLET
WS	WHITE



LIGHT SWITCH DETAILS

09/88

6300-00

1989

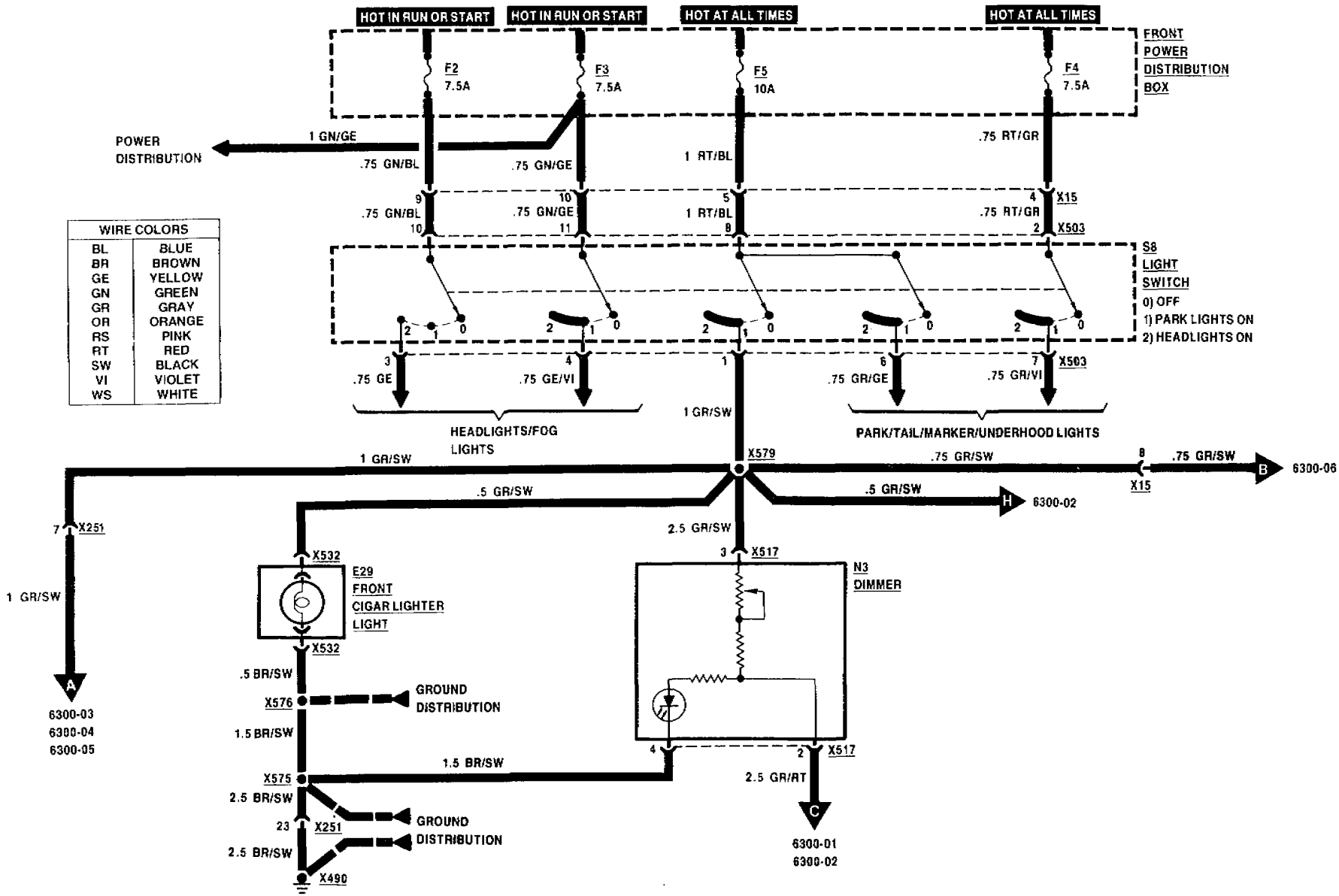

WIRE COLORS	
BL	BLUE
BR	BROWN
GE	YELLOW
GN	GREEN
GR	GRAY
OR	ORANGE
RS	PINK
RT	RED
SW	BLACK
VI	VIOLET
WS	WHITE

7 X251
1 GR/SW
A
6300-03
6300-04
6300-05

X532
E29
FRONT
CIGAR LIGHTER
LIGHT
X532
.5 BR/SW
X576
GROUND
DISTRIBUTION
1.5 BR/SW
X575
2.5 BR/SW
23 X251
GROUND
DISTRIBUTION
2.5 BR/SW
X490

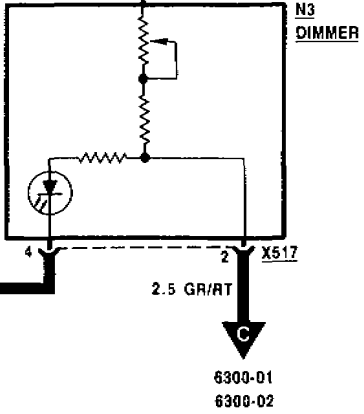

1 GR/SW
X579
1 GR/SW
PARK/TAIL/MARKER/UNDERHOOD LIGHTS
.75 GR/SW
B
6300-06
8 X15
6300-02
H
6300-02

FRONT POWER DISTRIBUTION BOX
F2 7.5A
F3 7.5A
F5 10A
F4 7.5A
S8 LIGHT SWITCH
0) OFF
1) PARK LIGHTS ON
2) HEADLIGHTS ON



LIGHT SWITCH DETAILS

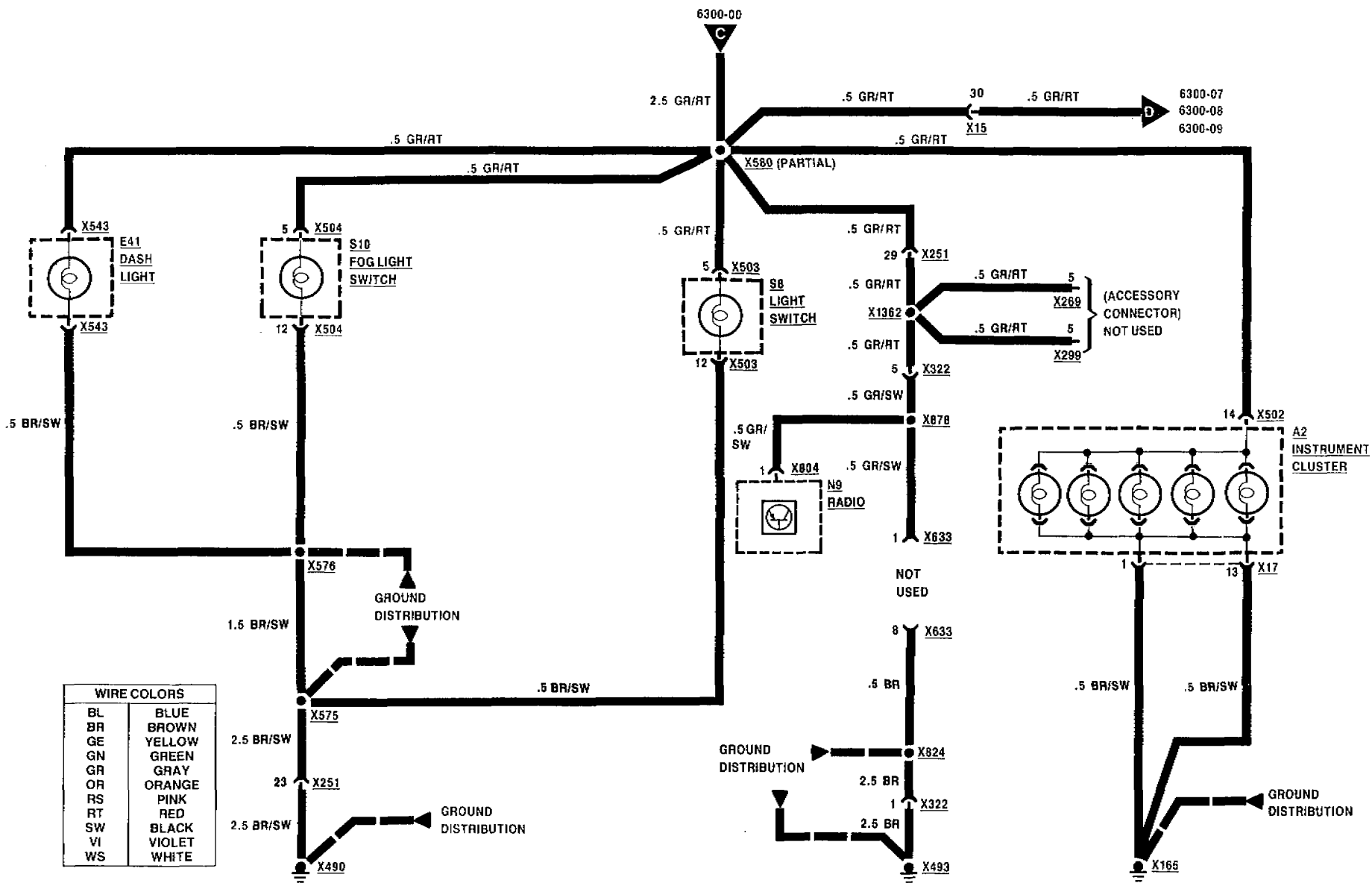

WIRE COLORS	
BL	BLUE
BR	BROWN
GE	YELLOW
GN	GREEN
GR	GRAY
OR	ORANGE
RS	PINK
RT	RED
SW	BLACK
VI	VIOLET
WS	WHITE

LIGHT SWITCH DETAILS

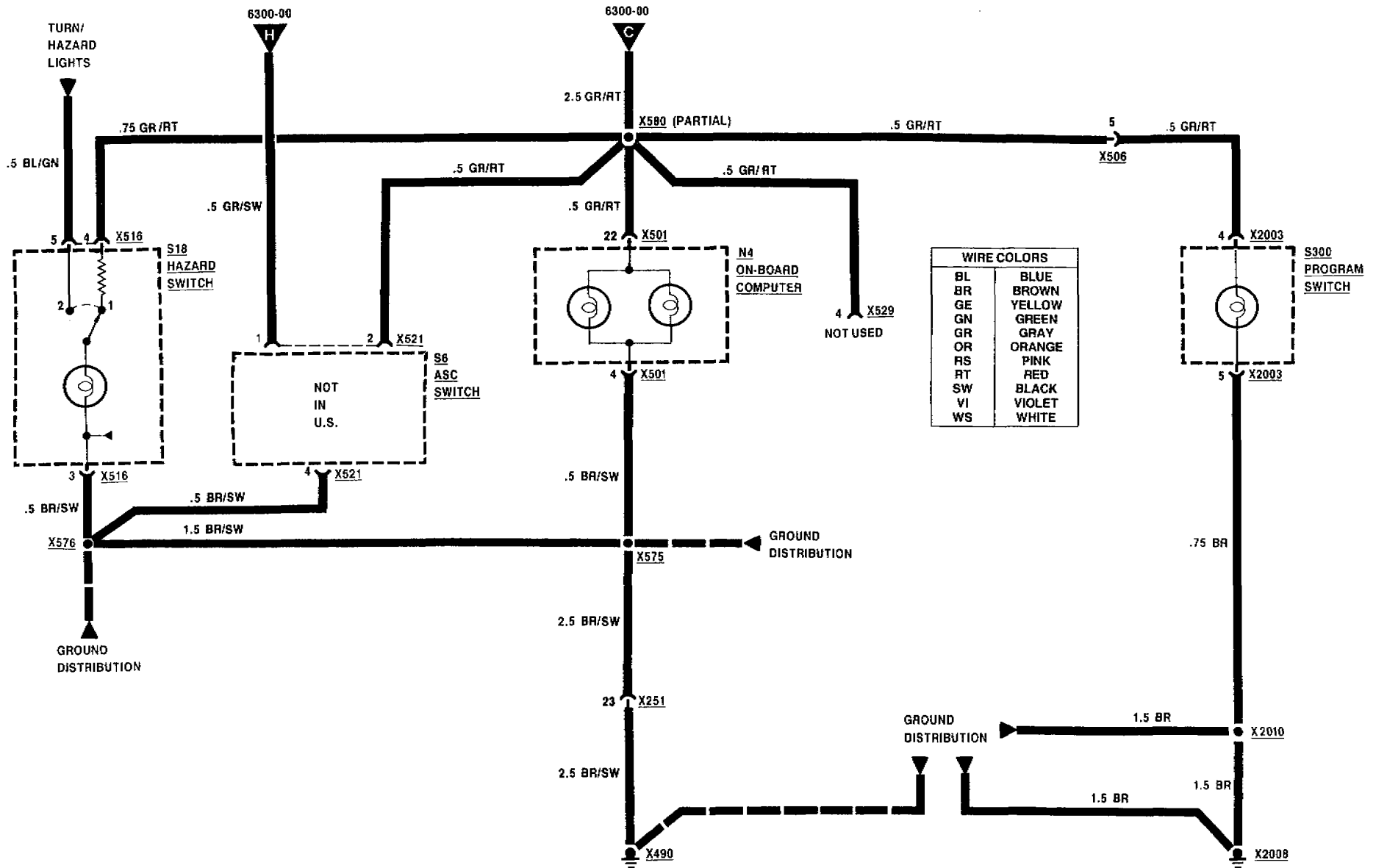



LIGHT SWITCH DETAILS

09/88

6300-03

1989

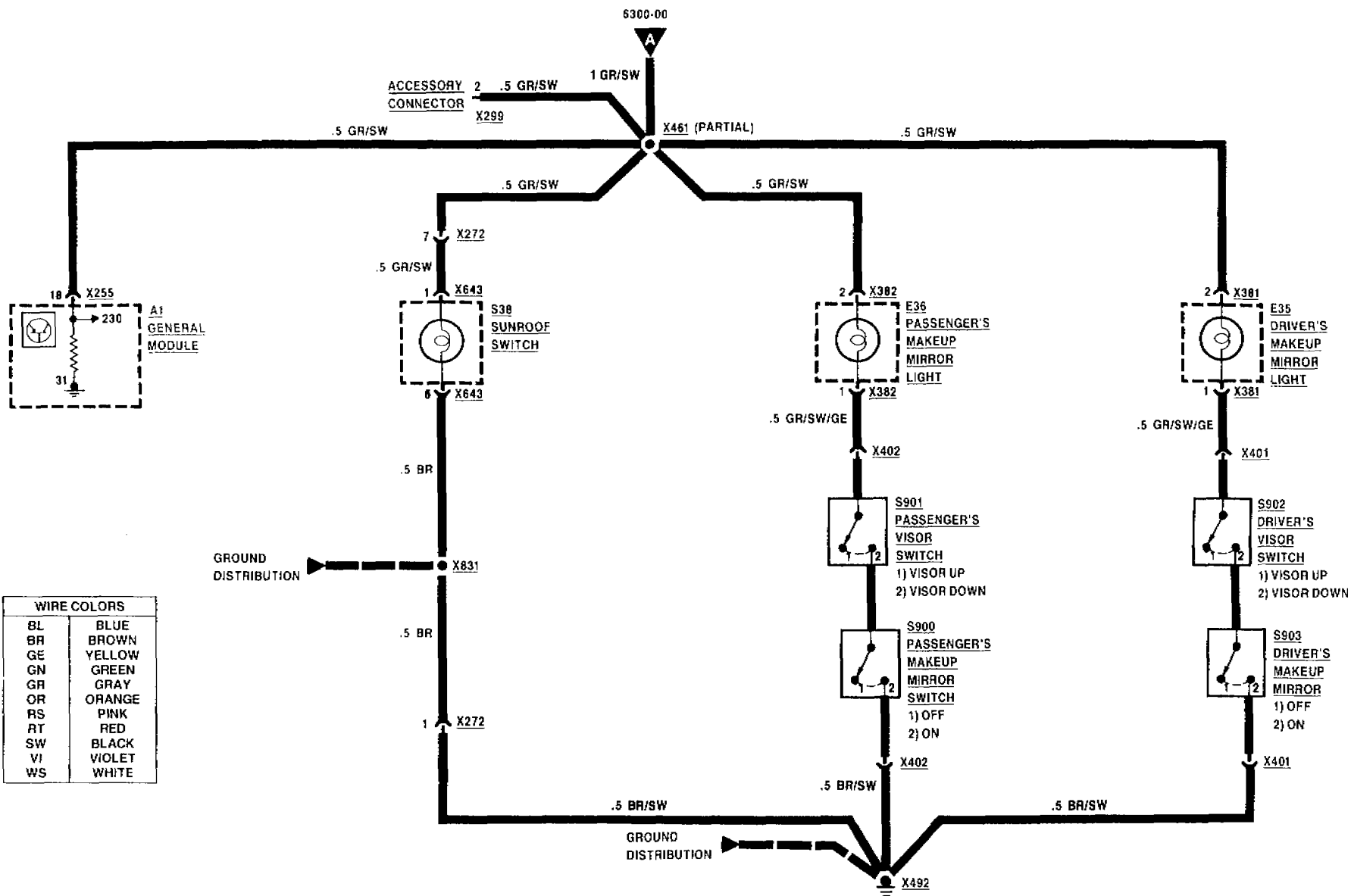

WIRE COLORS	
BL	BLUE
BR	BROWN
GE	YELLOW
GN	GREEN
GR	GRAY
OR	ORANGE
RS	PINK
RT	RED
SW	BLACK
VI	VIOLET
WS	WHITE

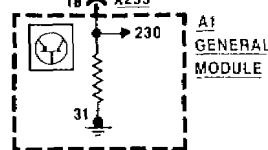

GROUND DISTRIBUTION

GROUND DISTRIBUTION



LIGHT SWITCH DETAILS

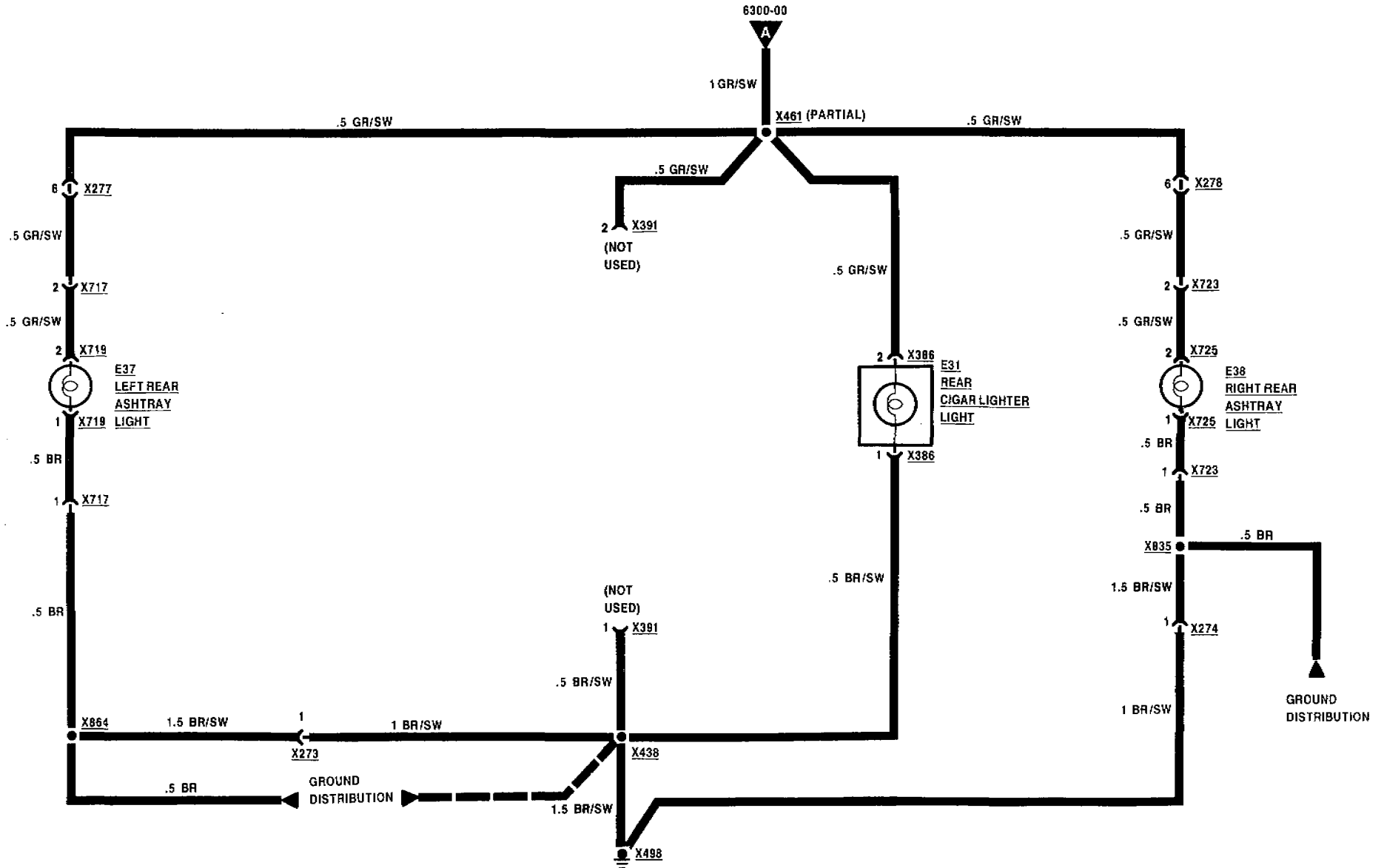



LIGHT SWITCH DETAILS

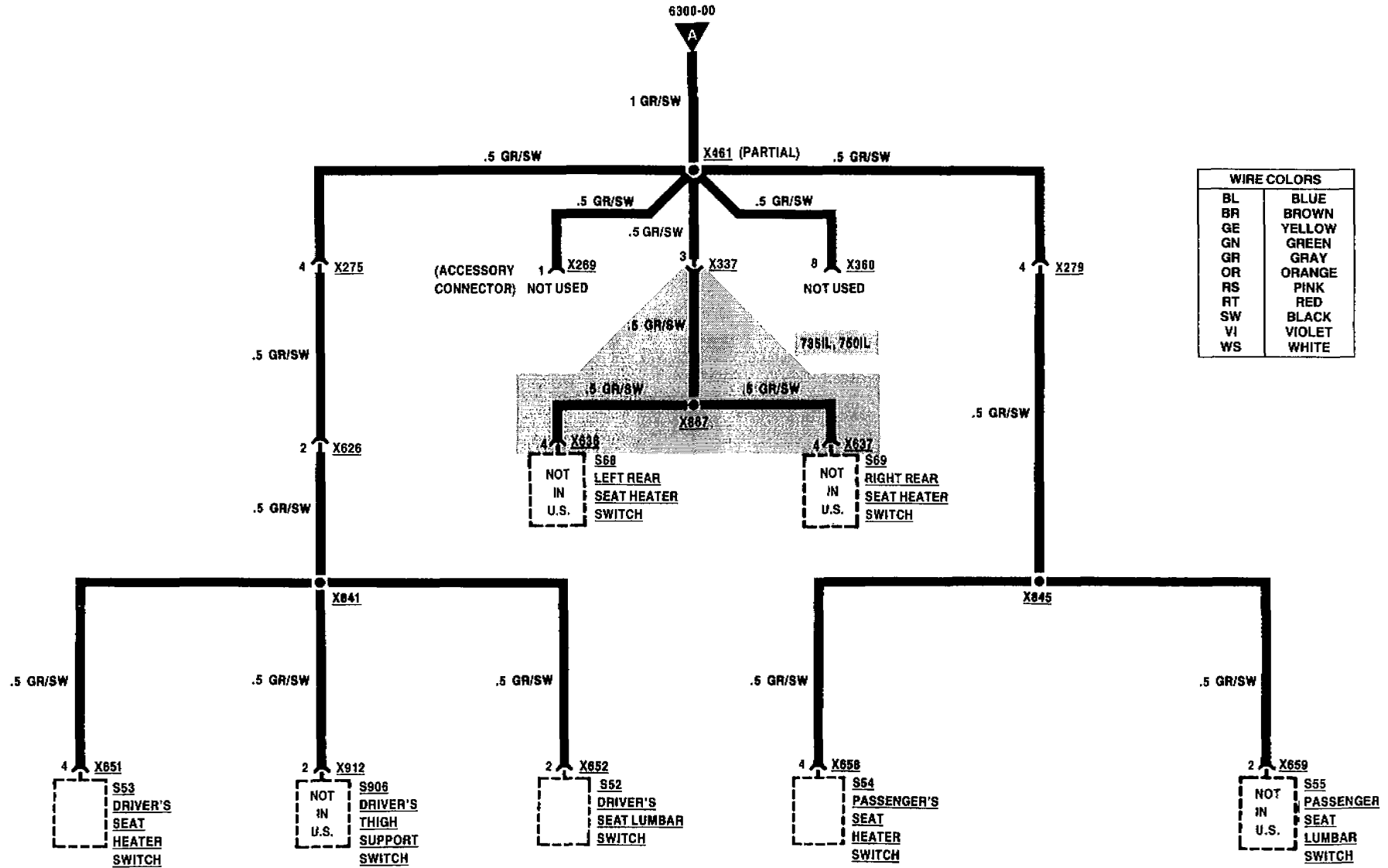



LIGHT SWITCH DETAILS

WIRE COLORS	
BL	BLUE
BR	BROWN
GE	YELLOW
GN	GREEN
GR	GRAY
OR	ORANGE
RS	PINK
RT	RED
SW	BLACK
VI	VIOLET
WS	WHITE

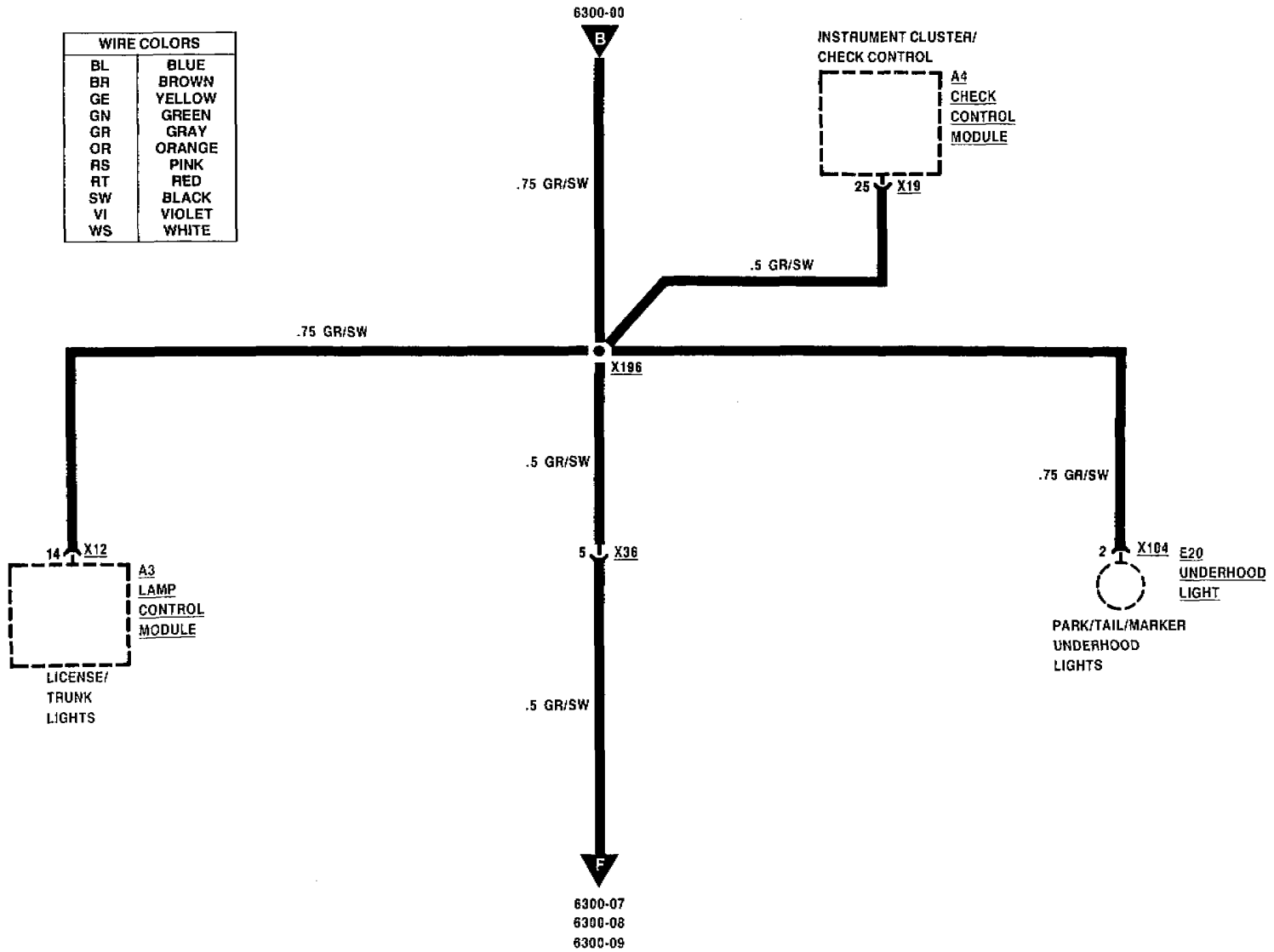

LIGHT SWITCH DETAILS

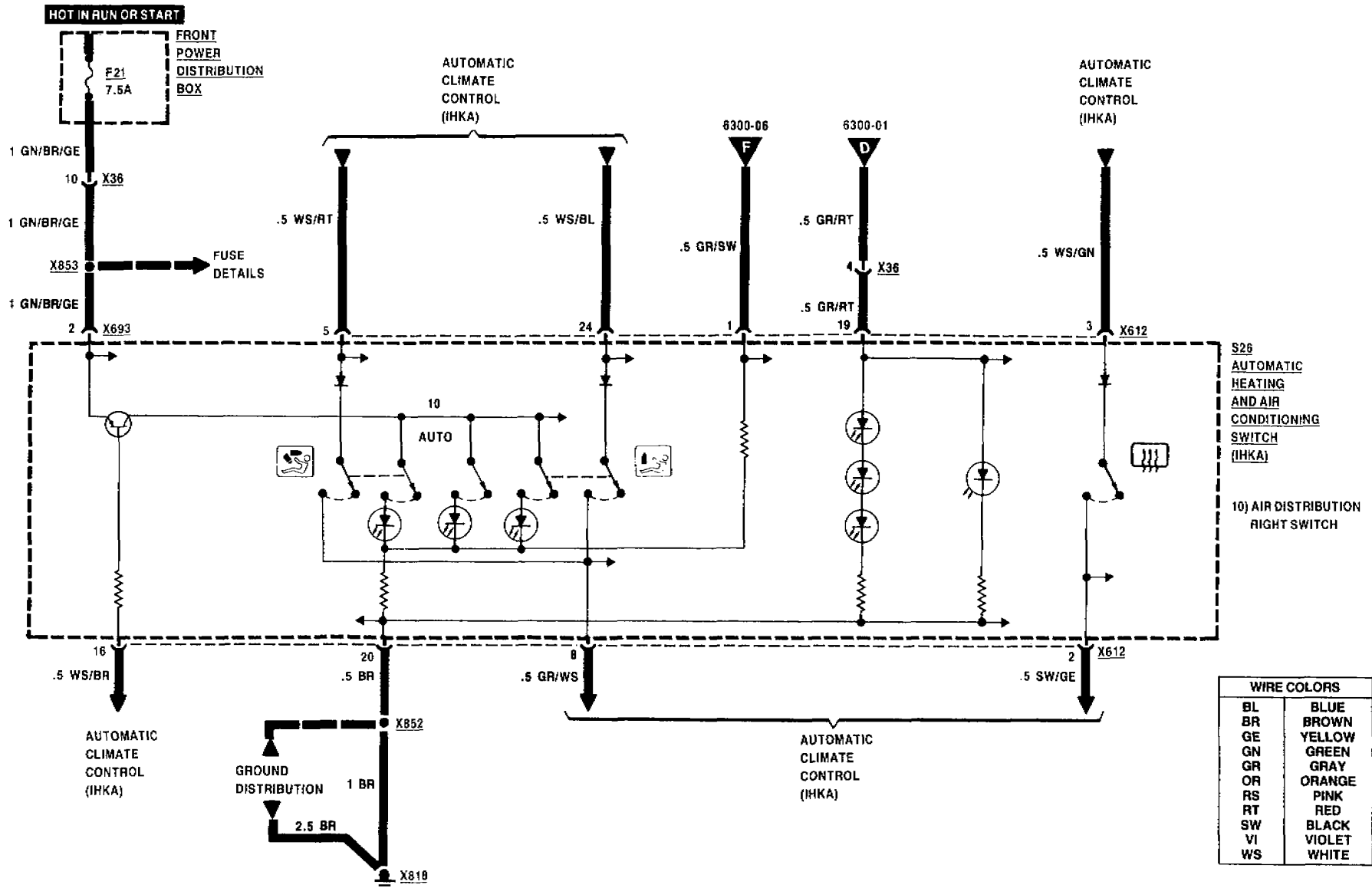



LIGHT SWITCH DETAILS

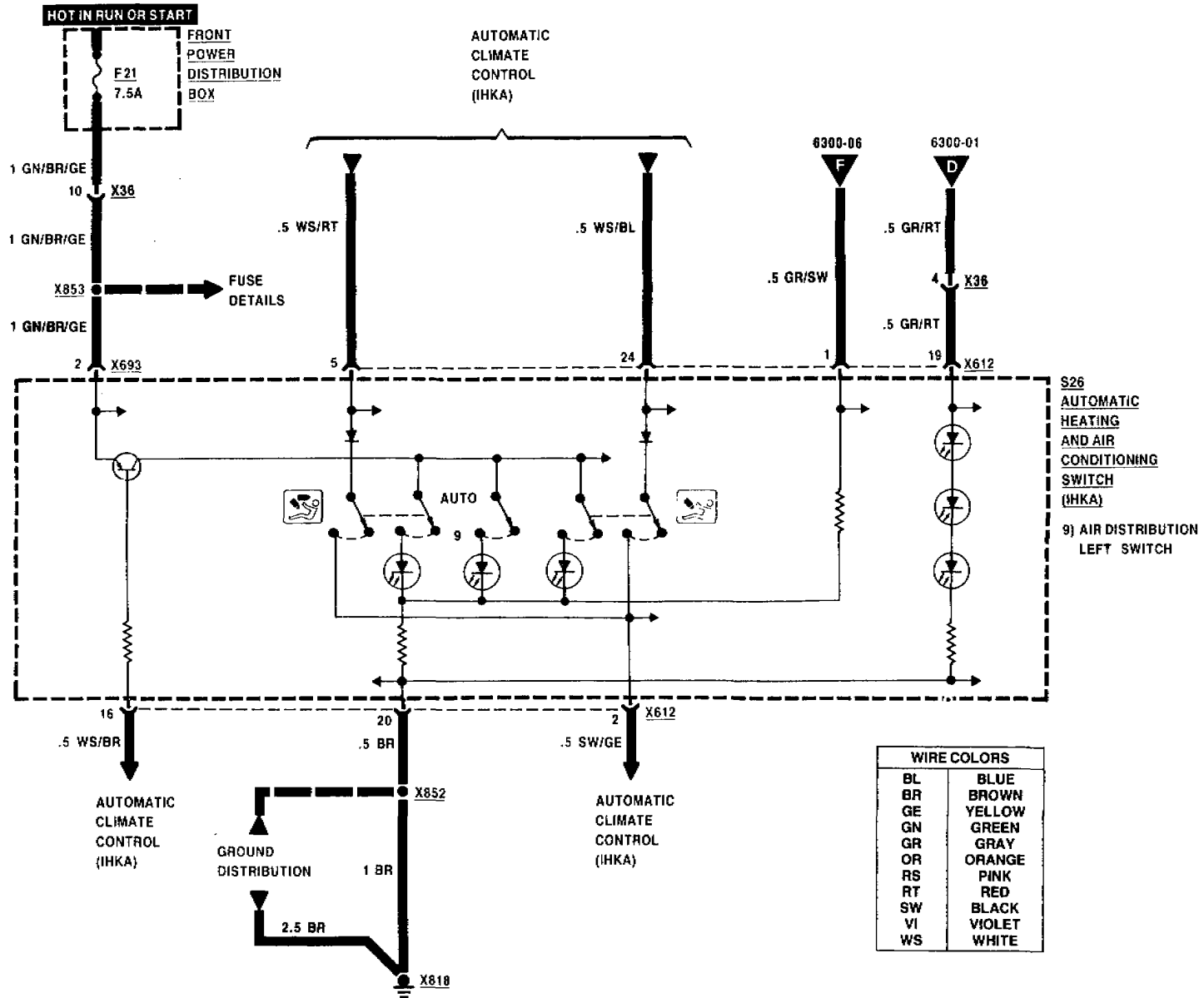

LIGHT SWITCH DETAILS

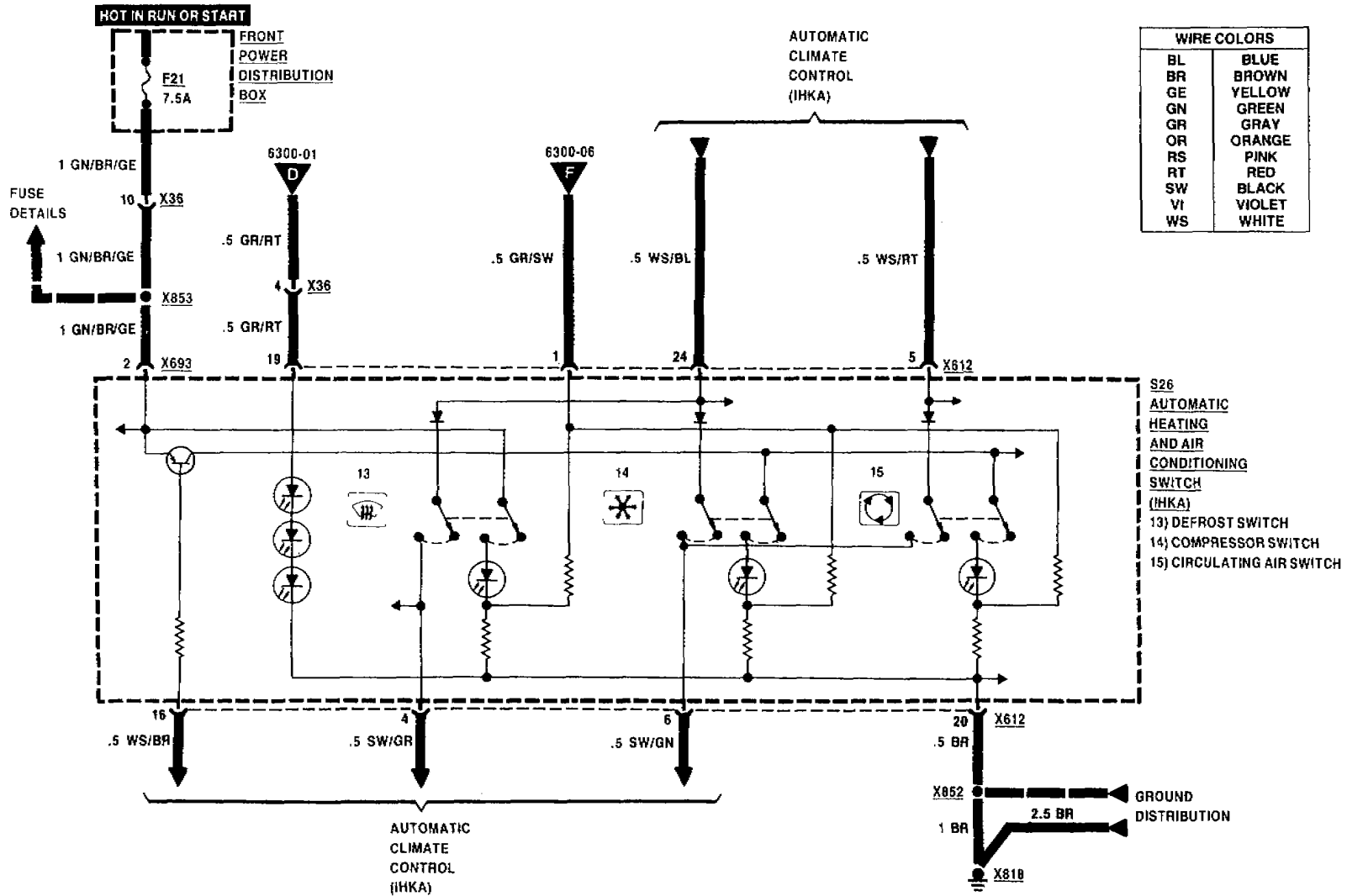

LAMP MONITOR (LKM)

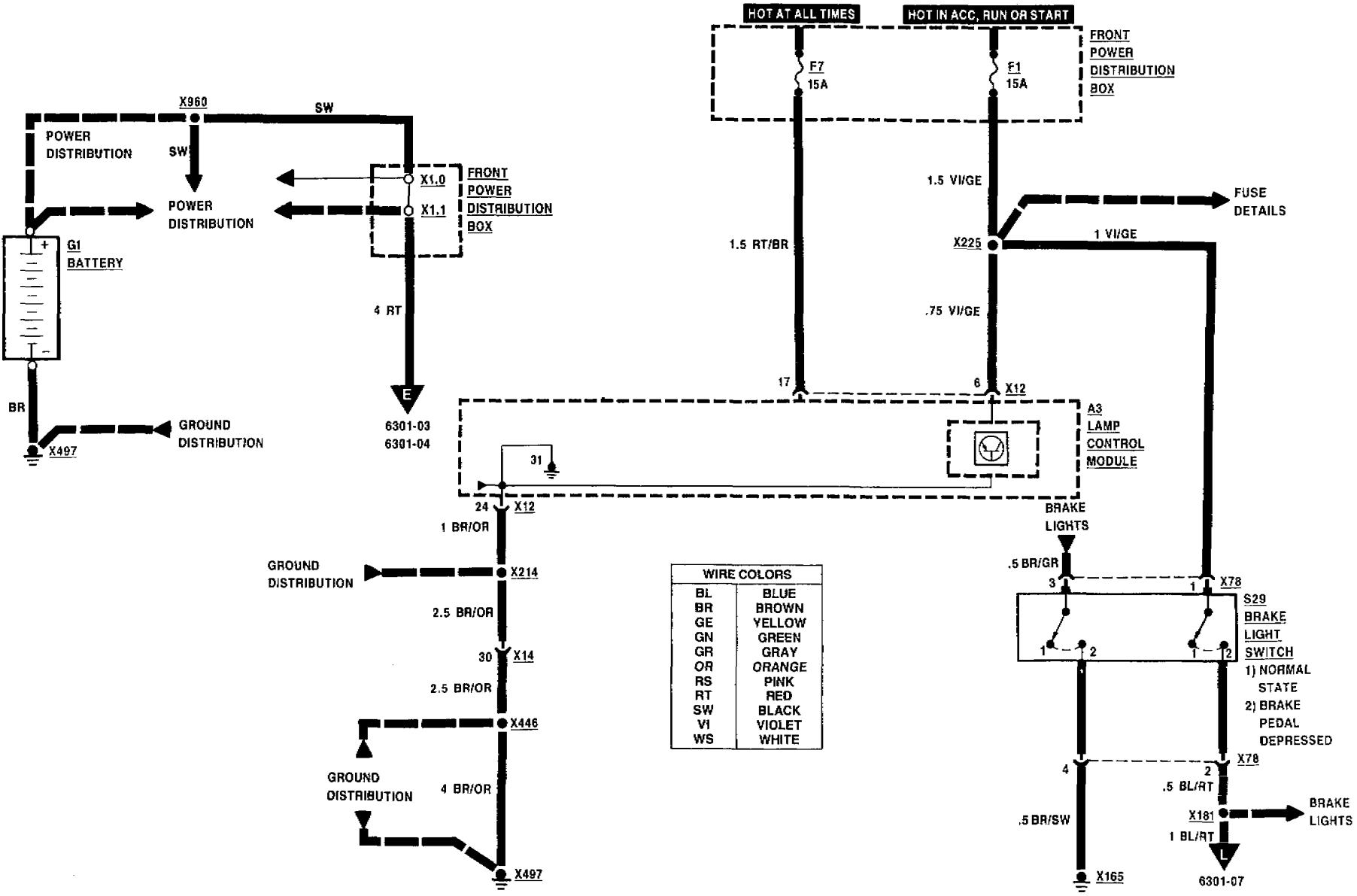



LAMP MONITOR (LKM)

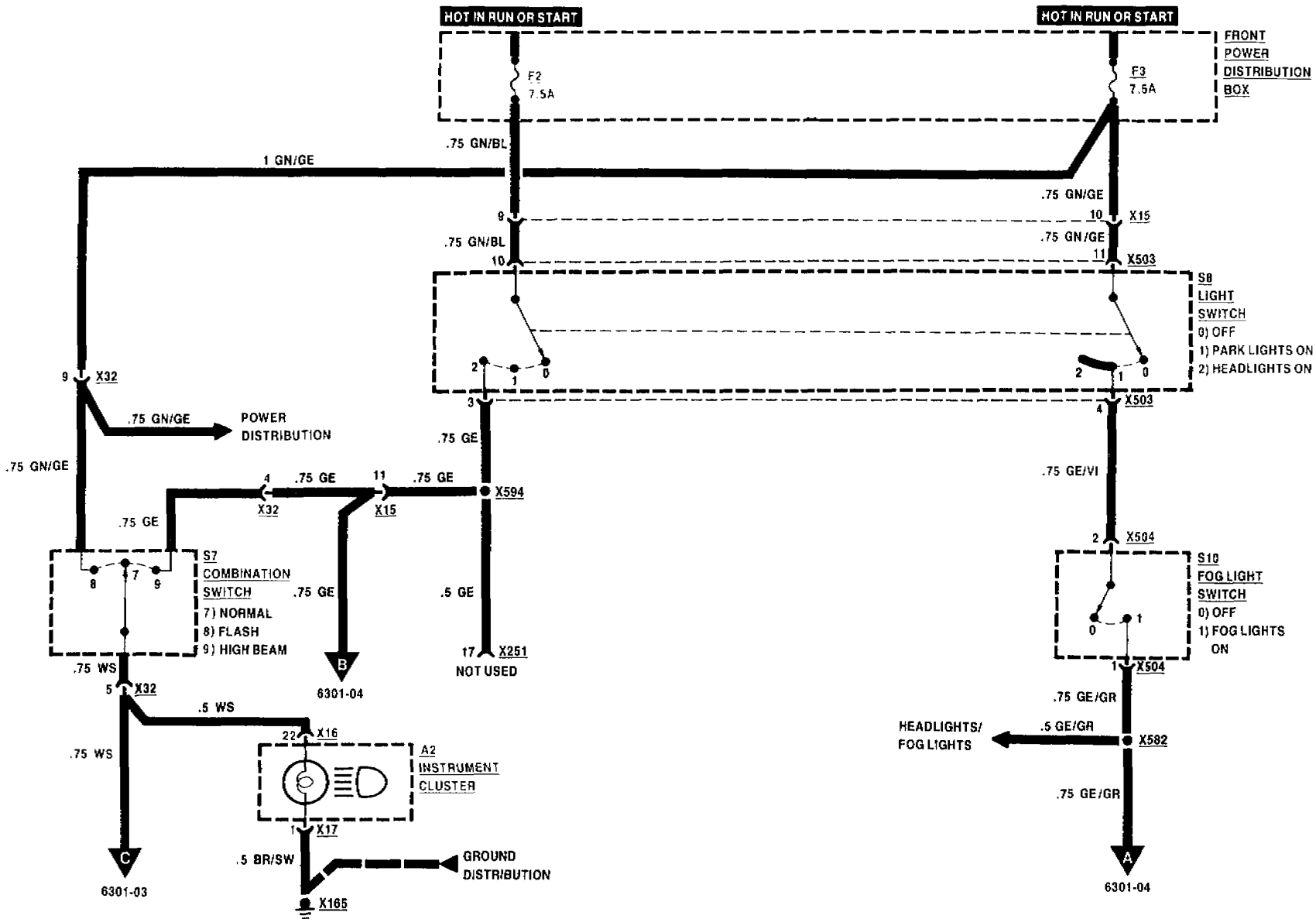

09/88

6301-01

1989



LAMP MONITOR (LKM)

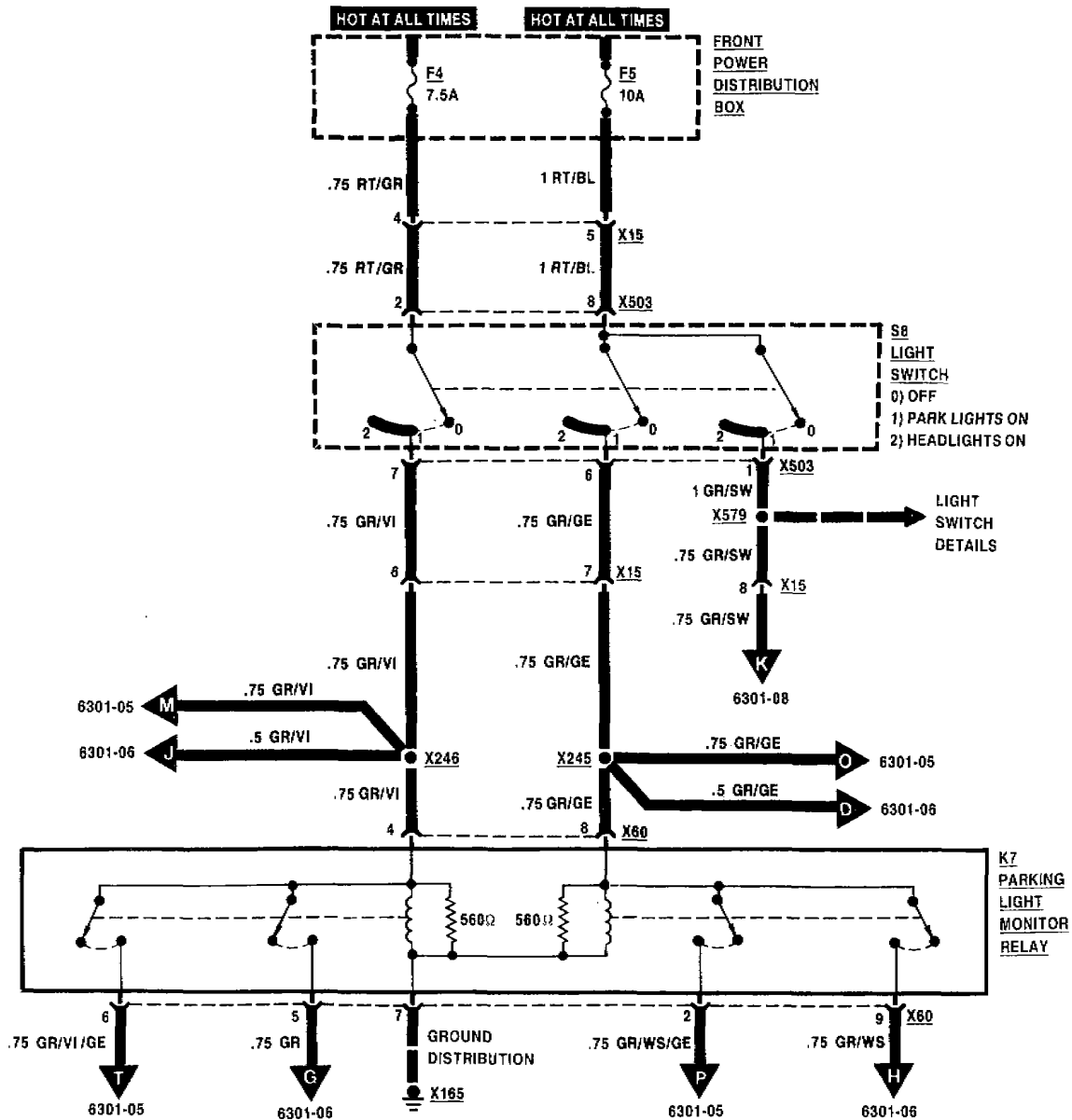

WIRE COLORS	
BL	BLUE
BR	BROWN
GE	YELLOW
GN	GREEN
GR	GRAY
OR	ORANGE
RS	PINK
RT	RED
SW	BLACK
VI	VIOLET
WS	WHITE



LAMP MONITOR (LKM)

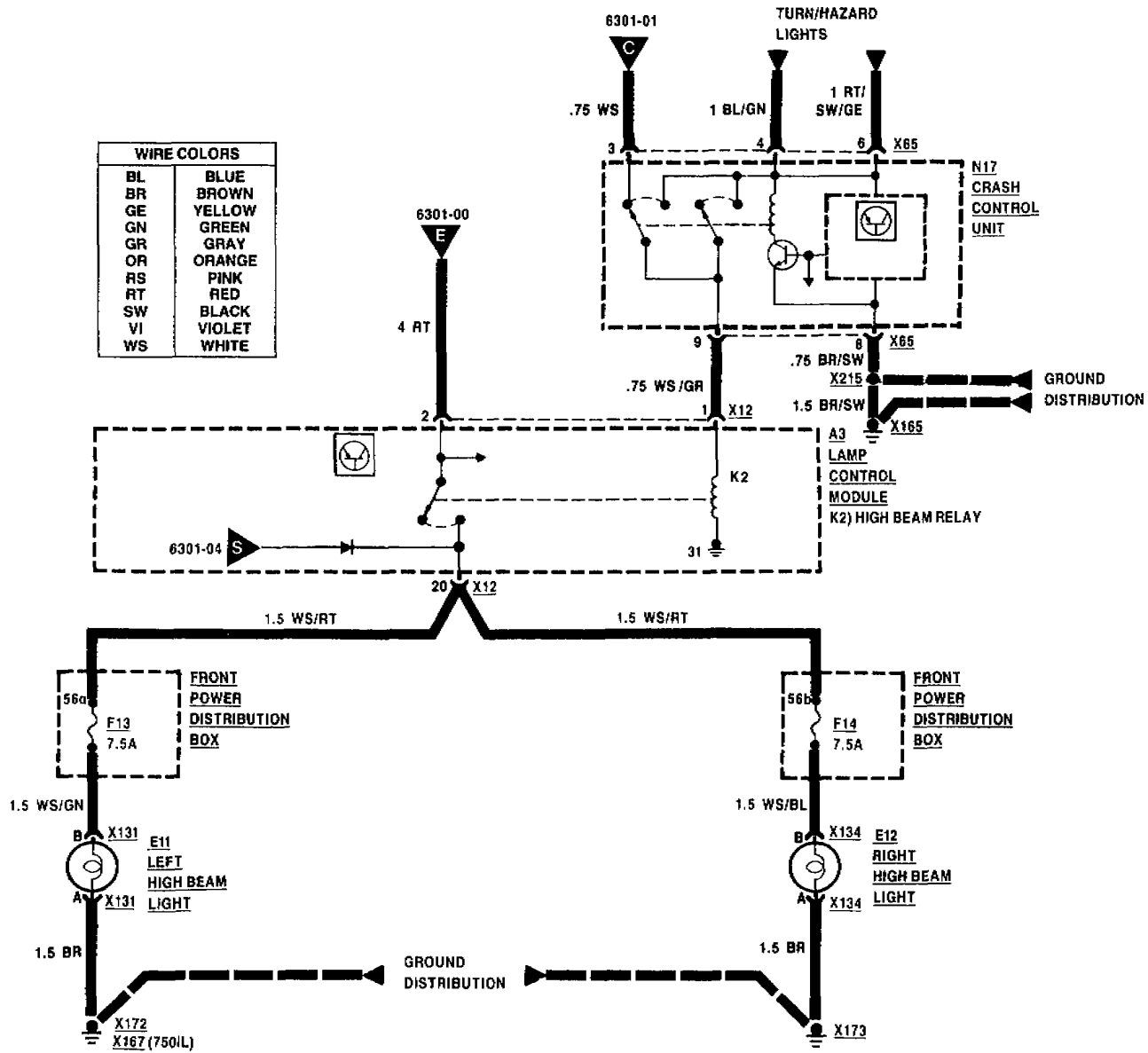

LAMP MONITOR (LKM)

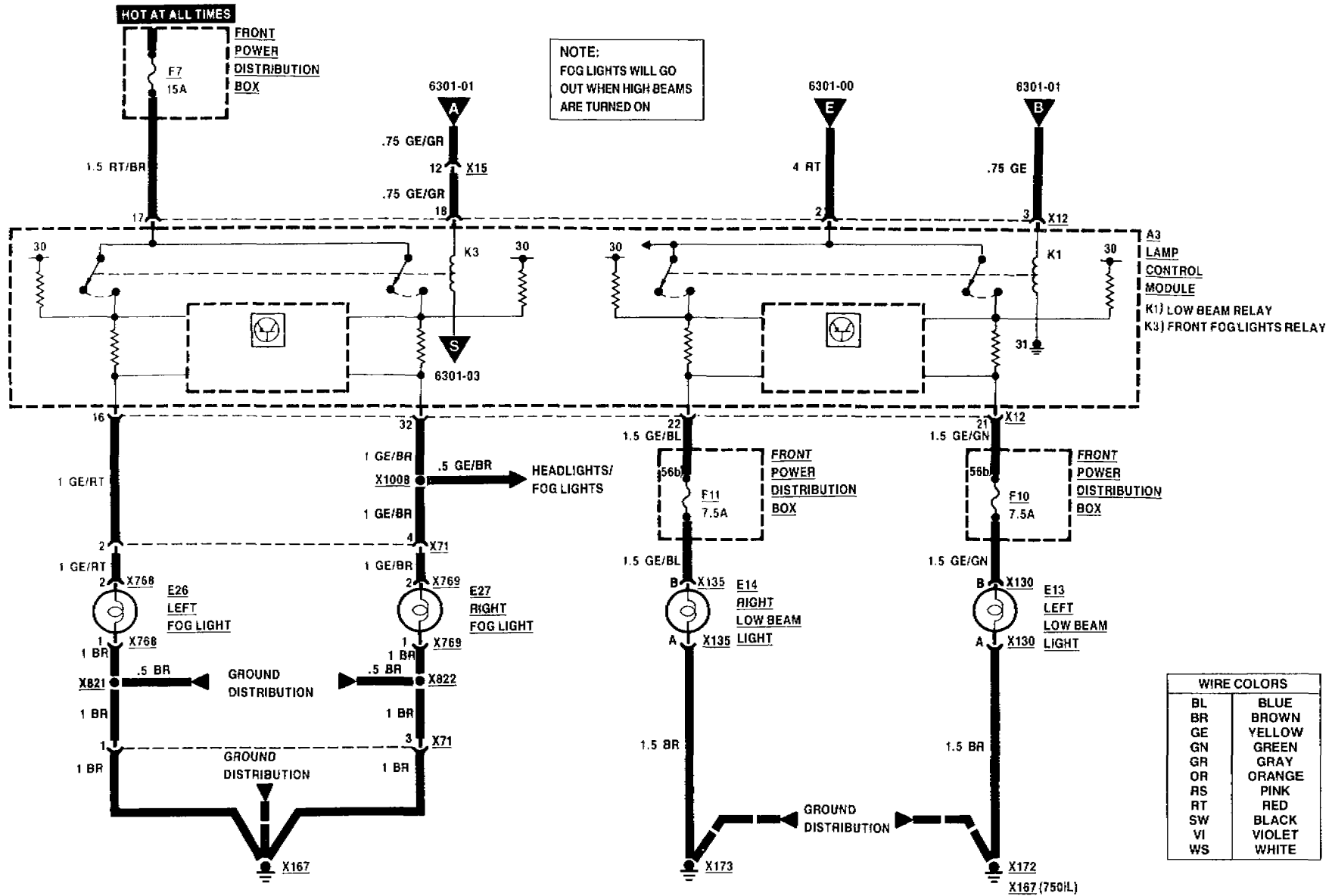



LAMP MONITOR (LKM)

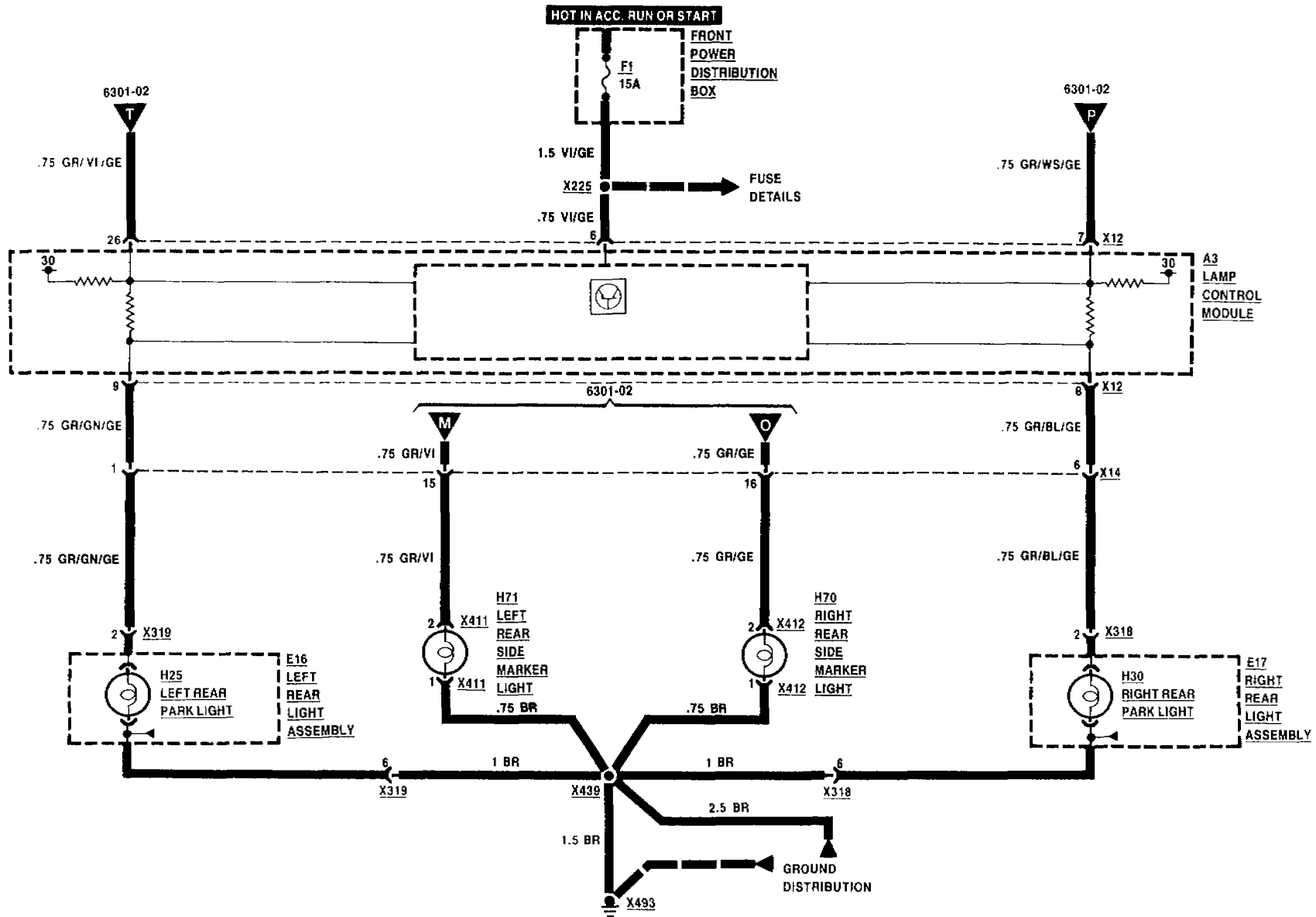



LAMP MONITOR (LKM)

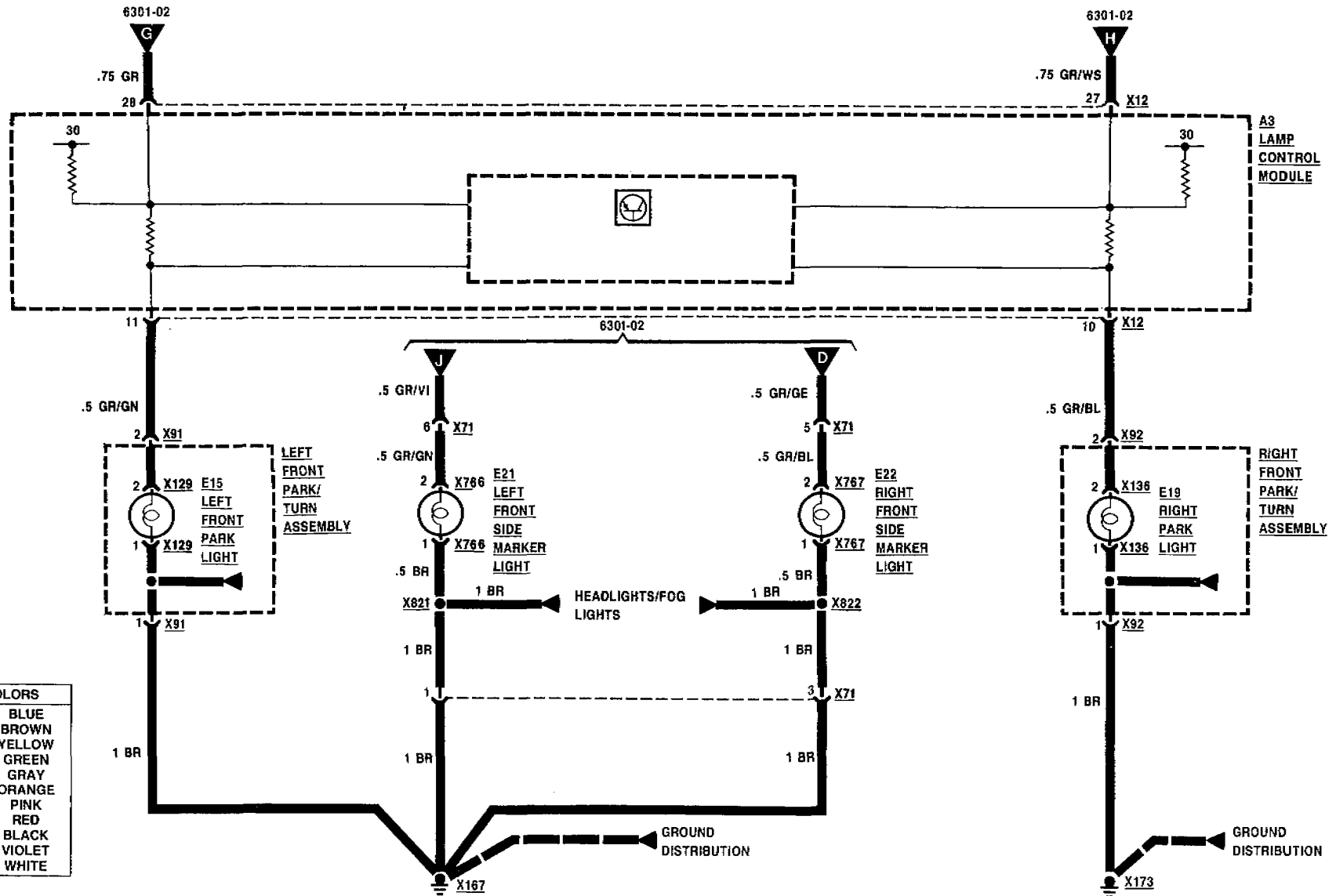



LAMP MONITOR (LKM)

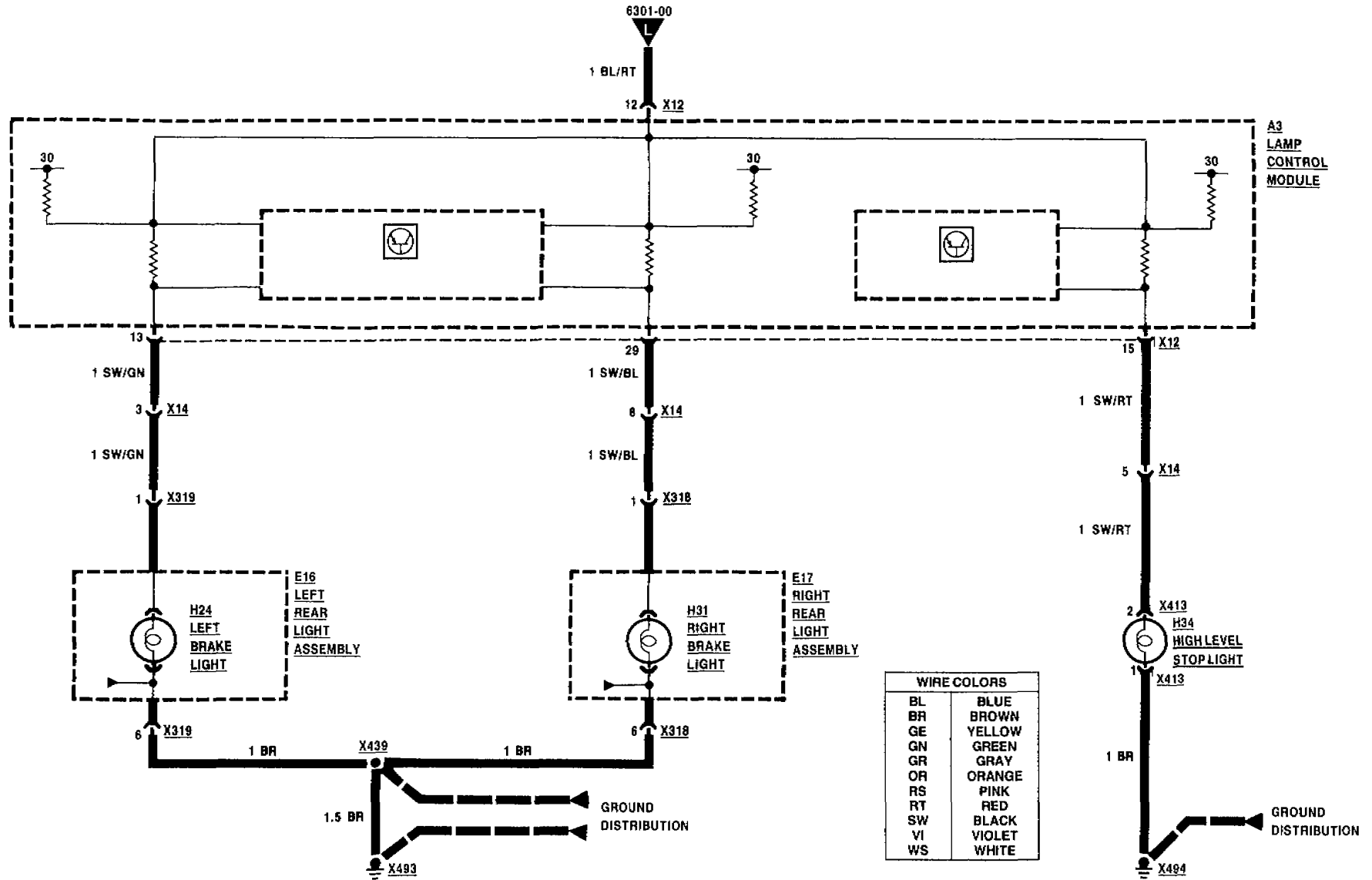



LAMP MONITOR (LKM)

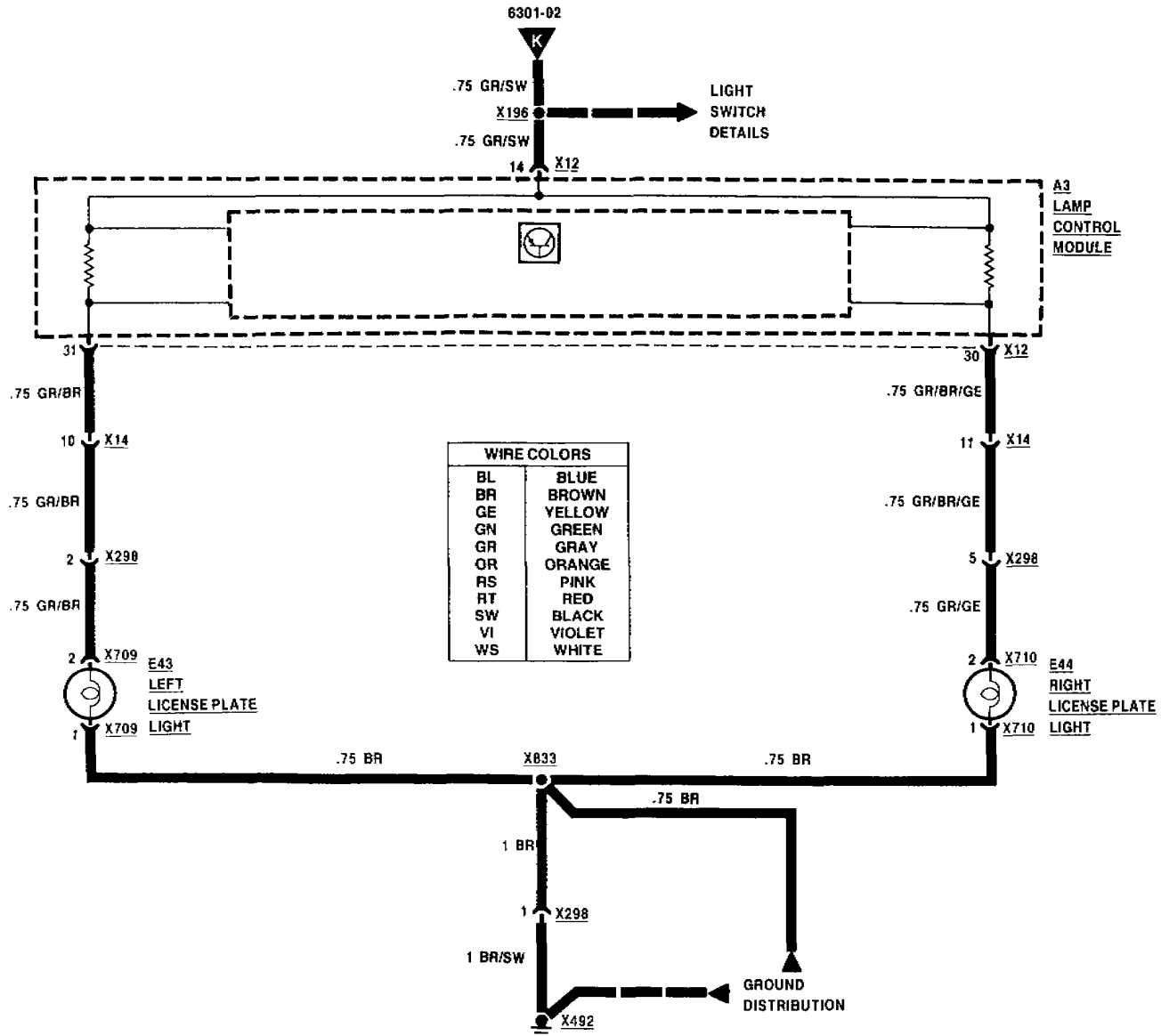



LAMP MONITOR (LKM) DATA LINK

WIRE COLORS	
BL	BLUE
BR	BROWN
GE	YELLOW
GN	GREEN
GR	GRAY
OR	ORANGE
RS	PINK
RT	RED
SW	BLACK
VI	VIOLET
WS	WHITE

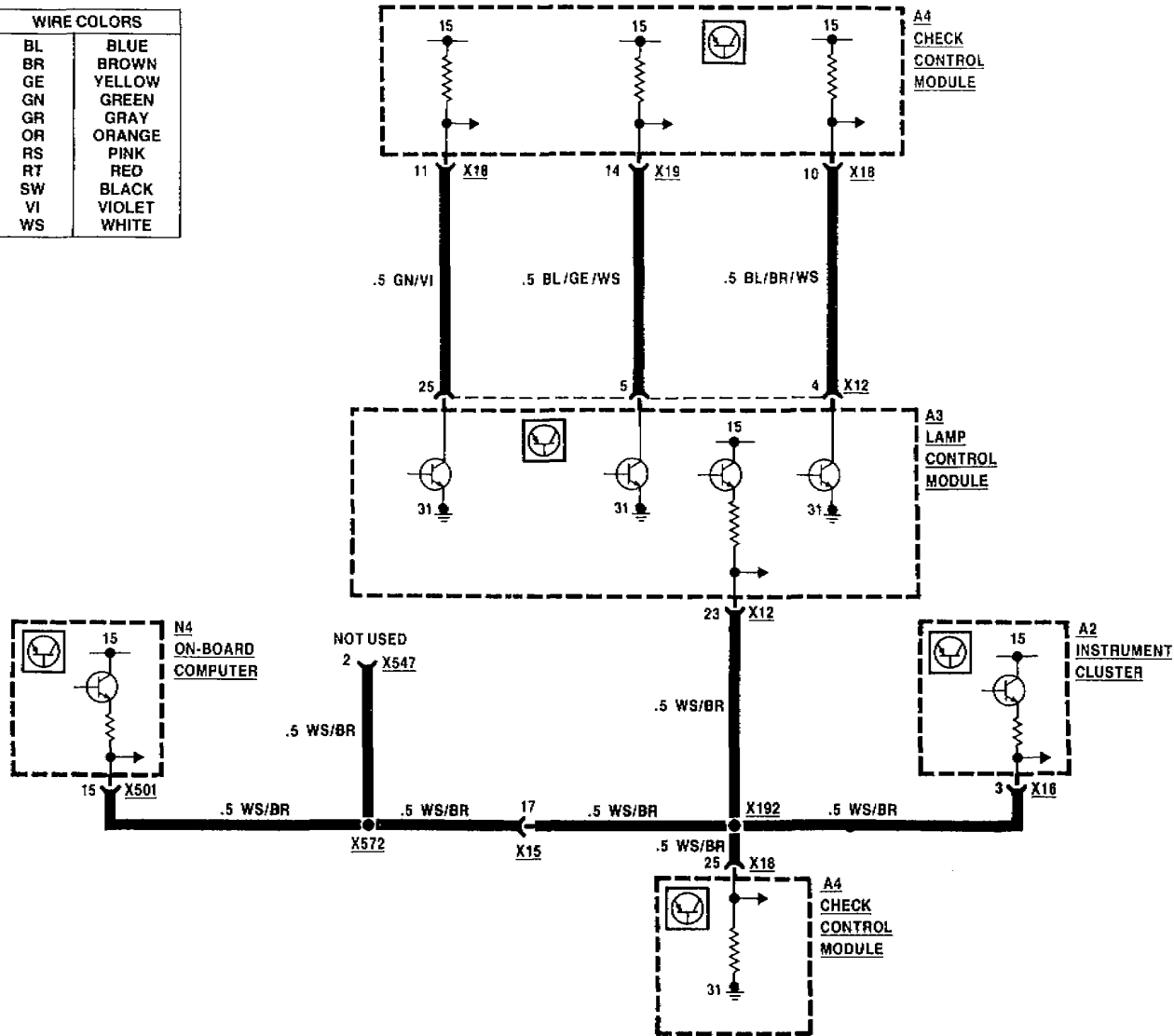



TURNOHAZARD LIGHTS

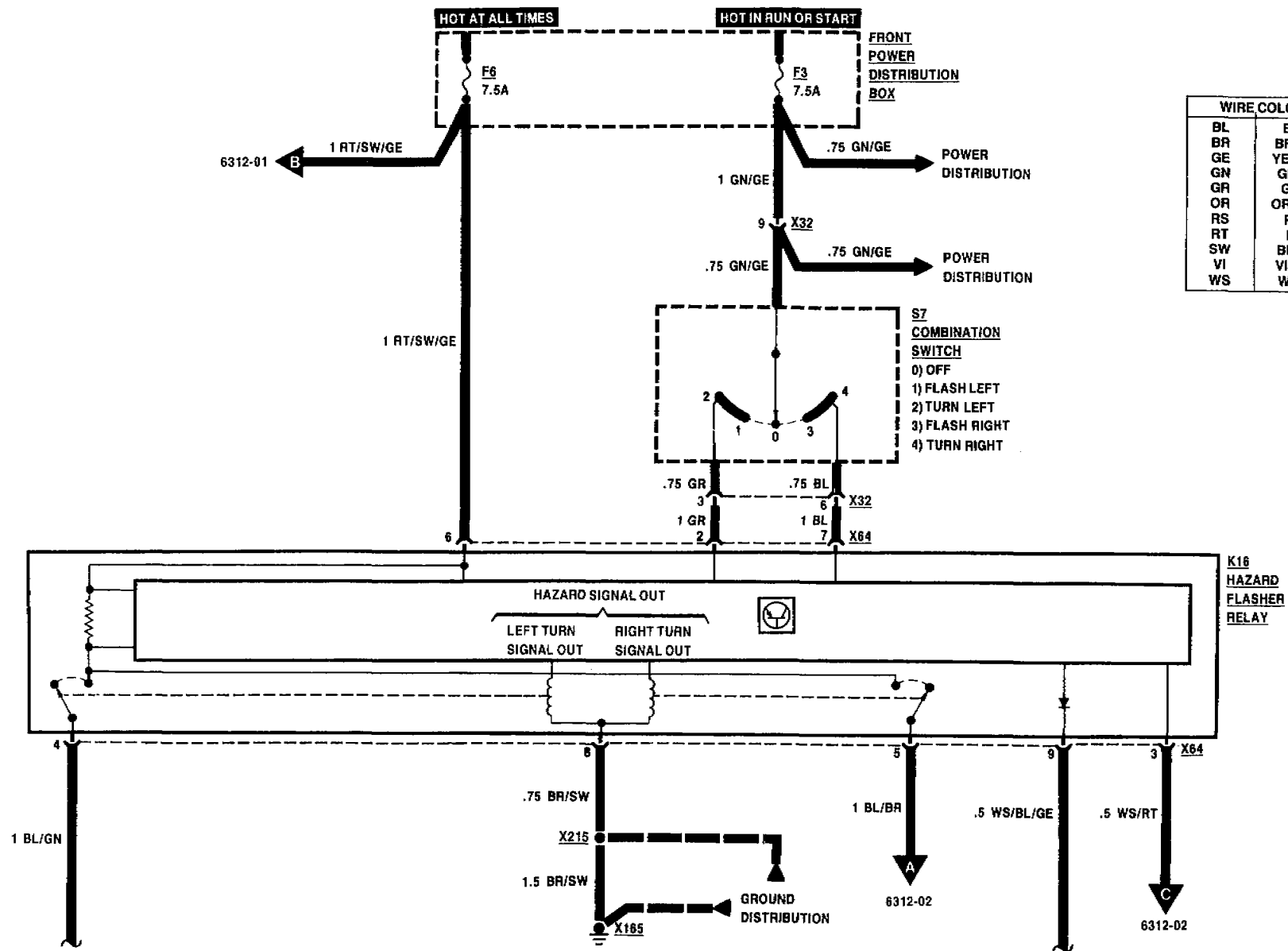

WIRE COLORS	
BL	BLUE
BR	BROWN
GE	YELLOW
GN	GREEN
GR	GRAY
OR	ORANGE
RS	PINK
RT	RED
SW	BLACK
VI	VIOLET
WS	WHITE

TURN/HAZARD LIGHTS

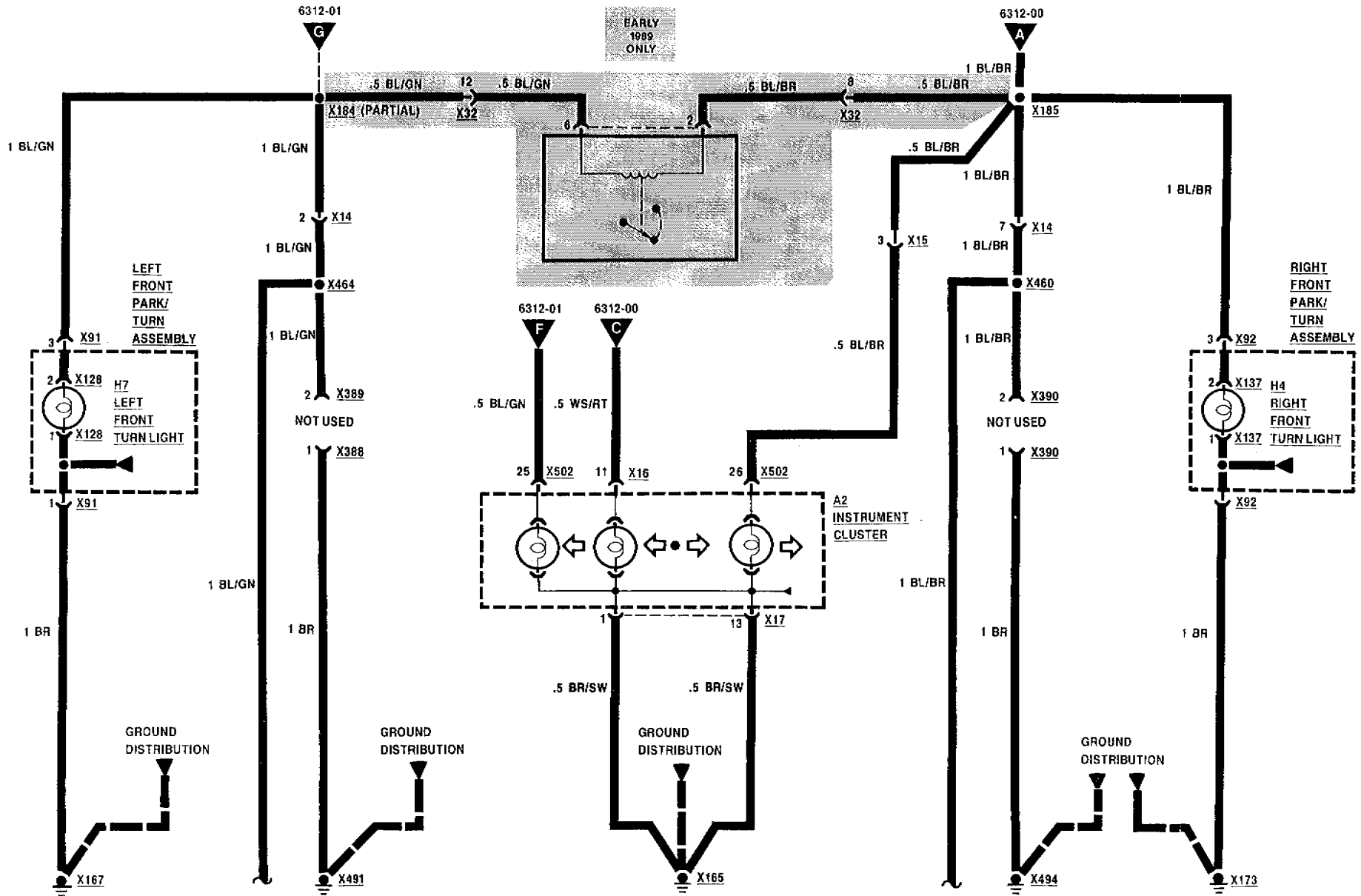

WIRE COLORS	
BL	BLUE
BR	BROWN
GE	YELLOW
GN	GREEN
GR	GRAY
OR	ORANGE
RS	PINK
RT	RED
SW	BLACK
VI	VIOLET
WS	WHITE

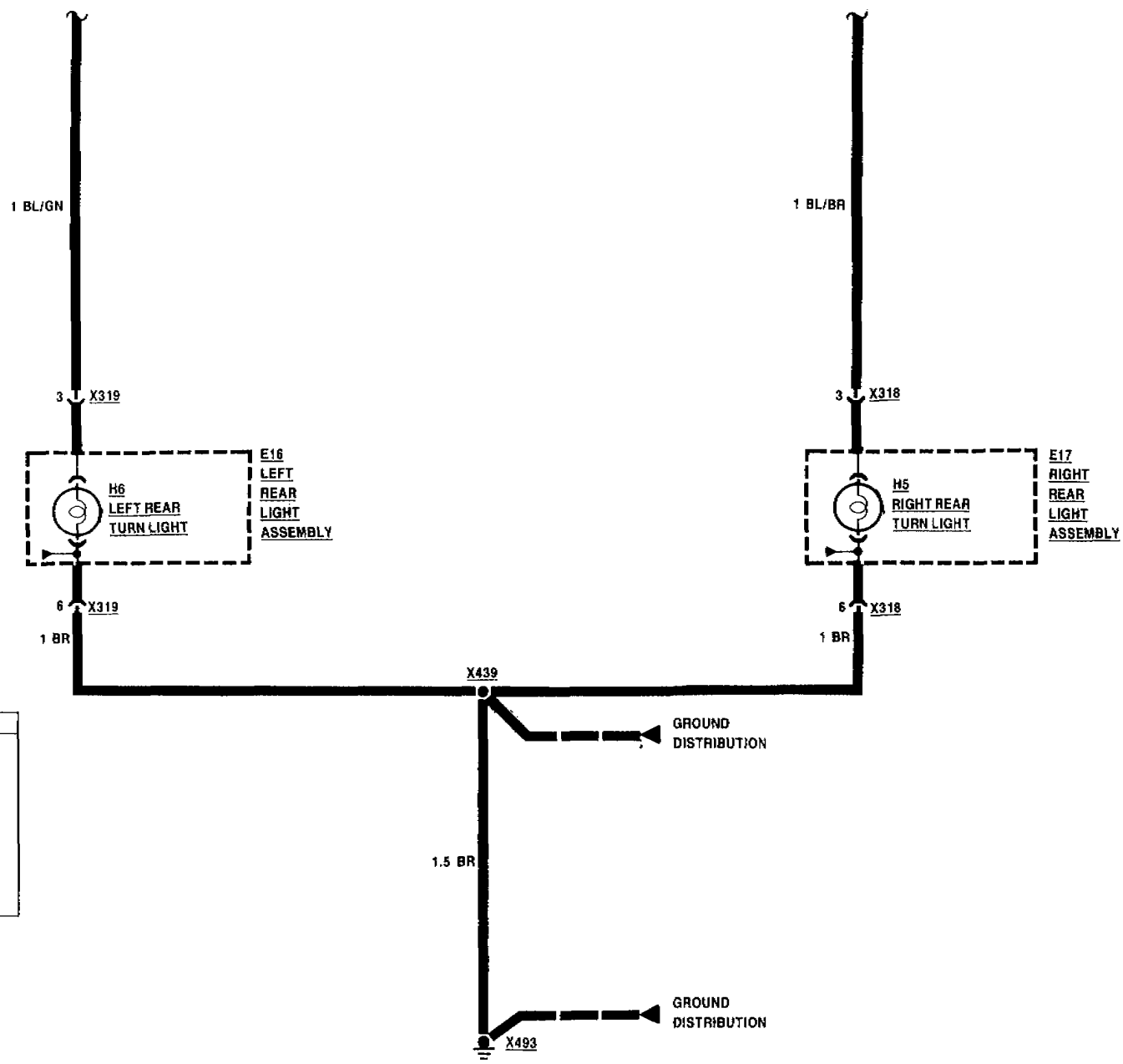

TURN/HAZARD LIGHTS

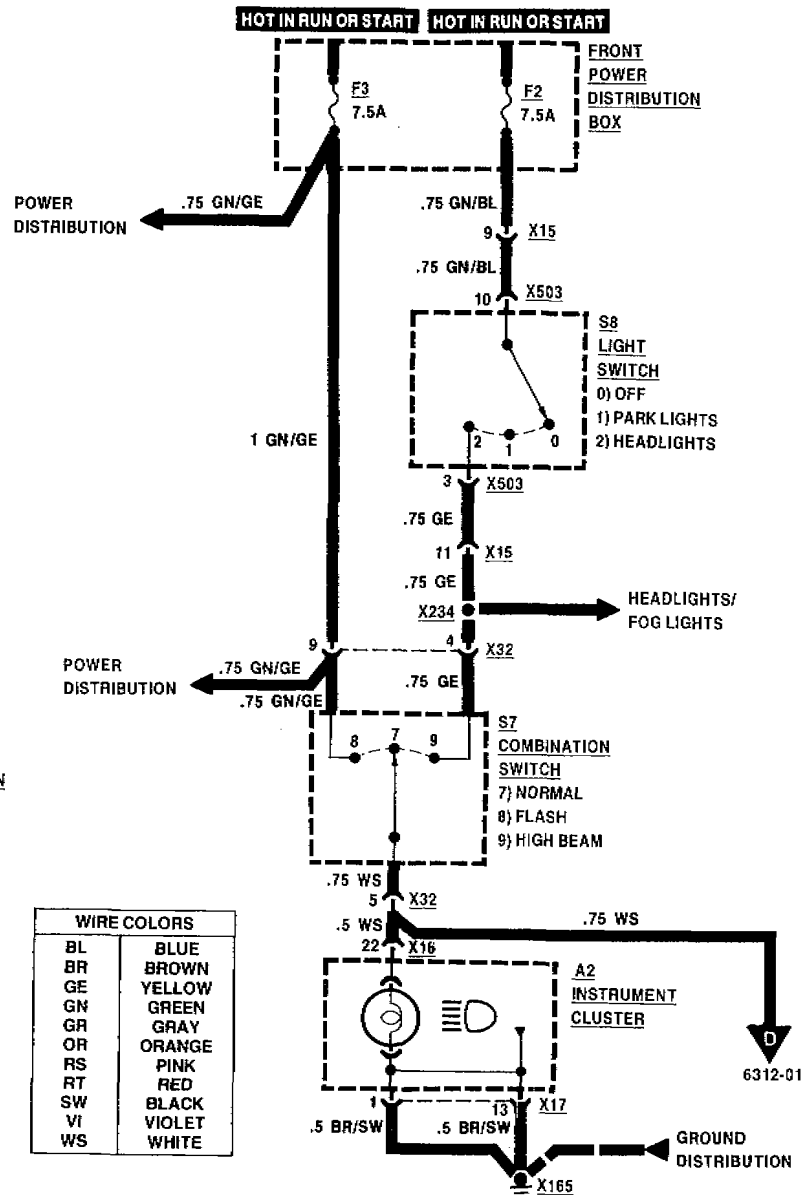
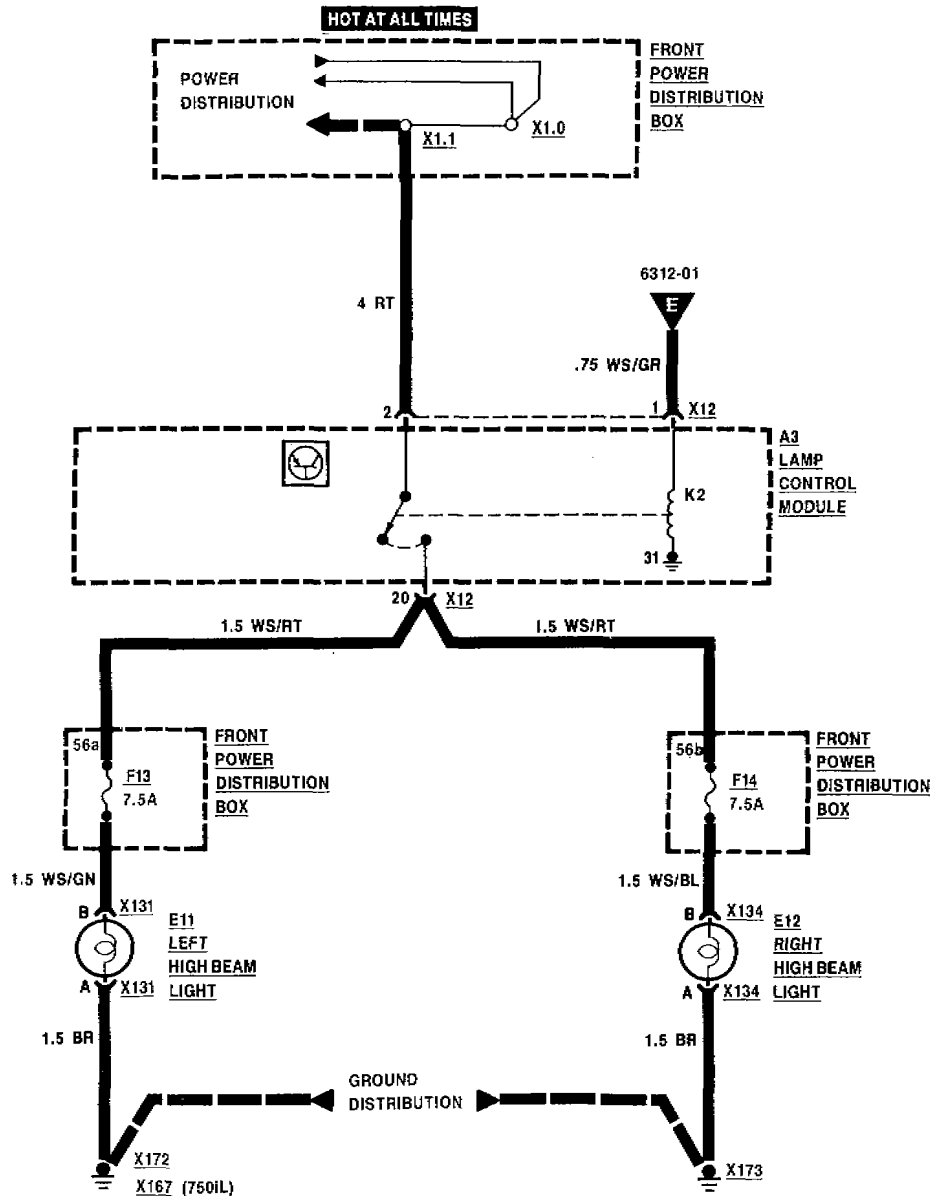

WIRE COLORS	
BL	BLUE
BR	BROWN
GE	YELLOW
GN	GREEN
GR	GRAY
OR	ORANGE
RS	PINK
RT	RED
SW	BLACK
VI	VIOLET
WS	WHITE

11/89

6312-04

1989

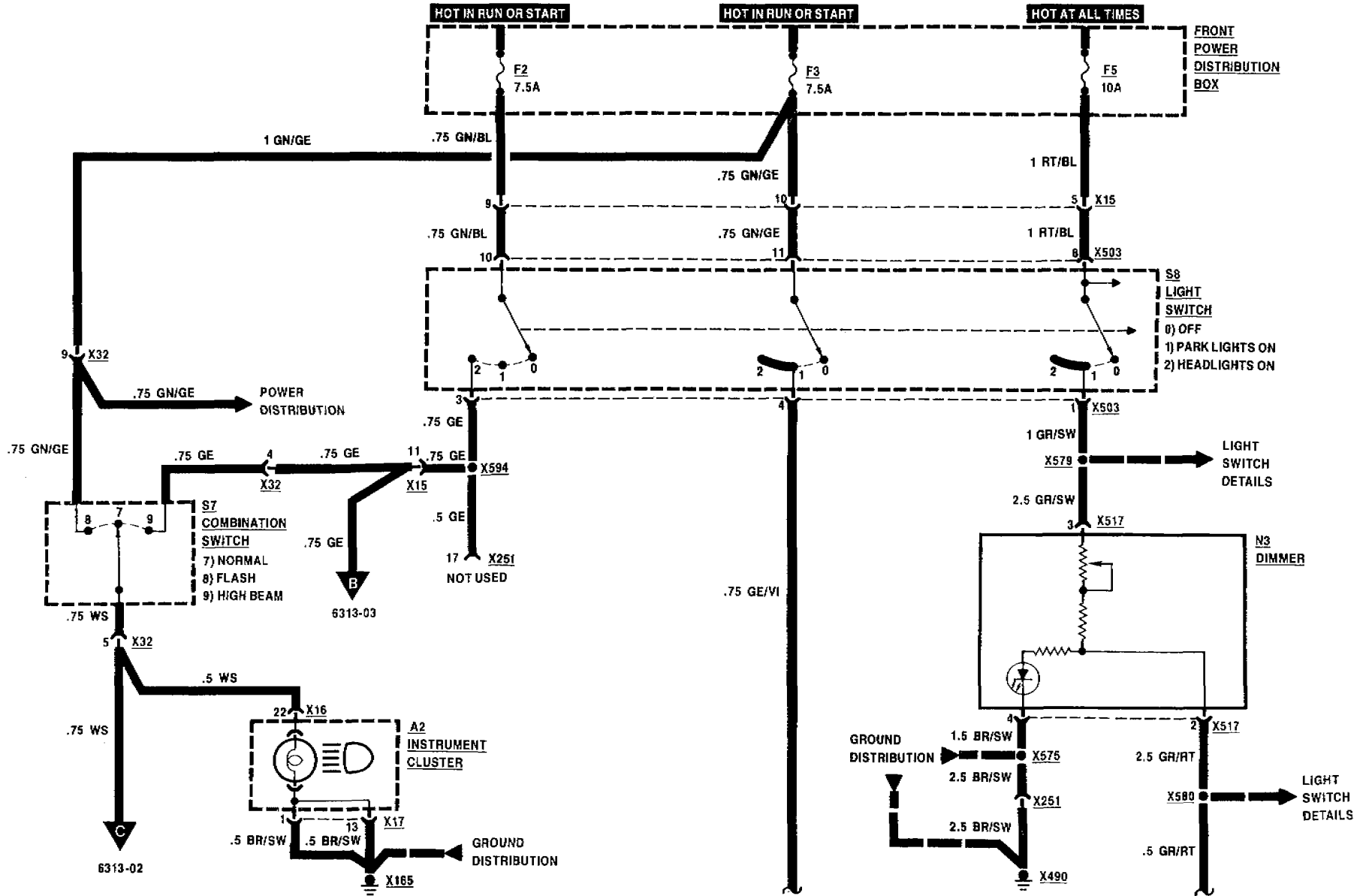

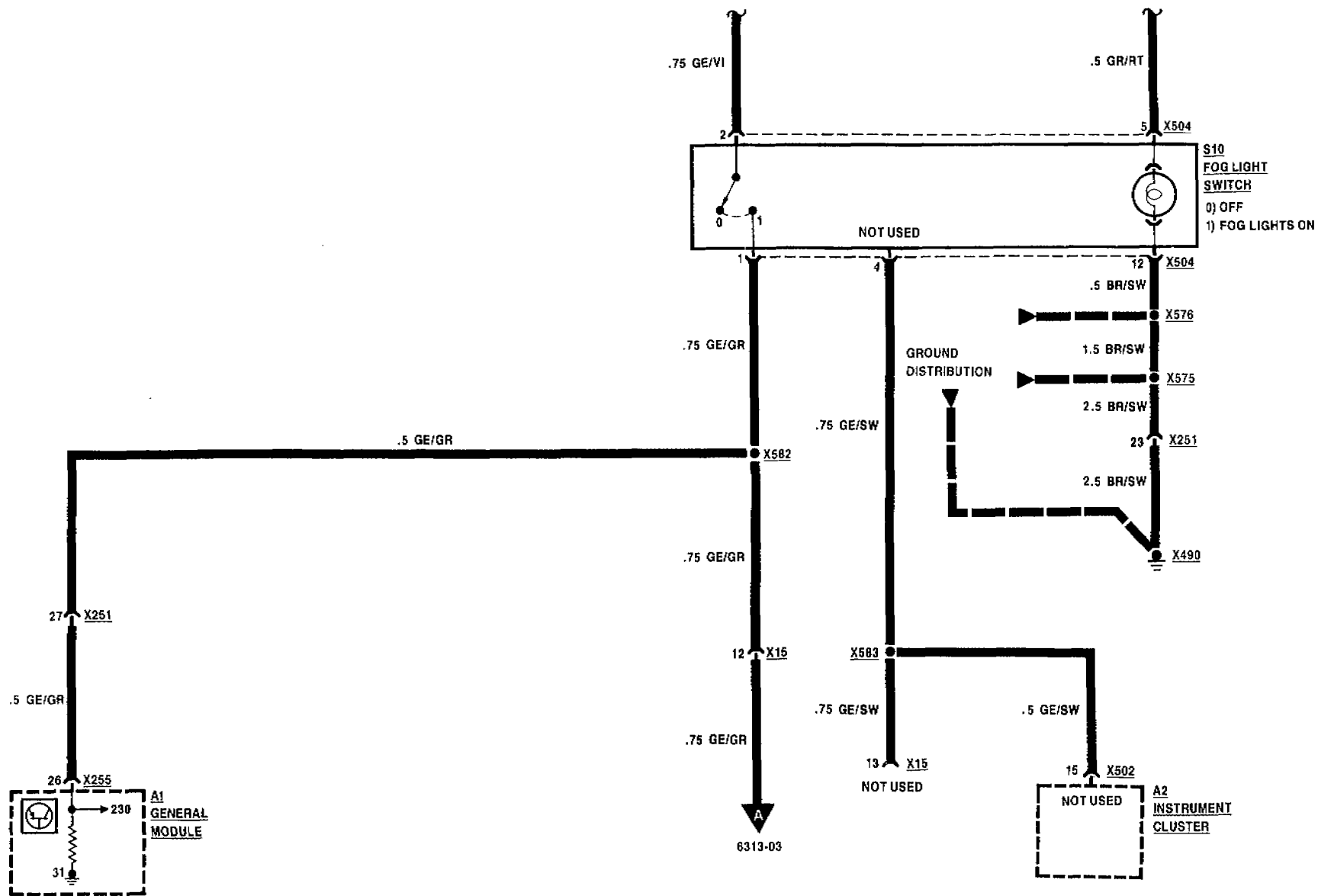



HEADLIGHTS/FOG LIGHTS

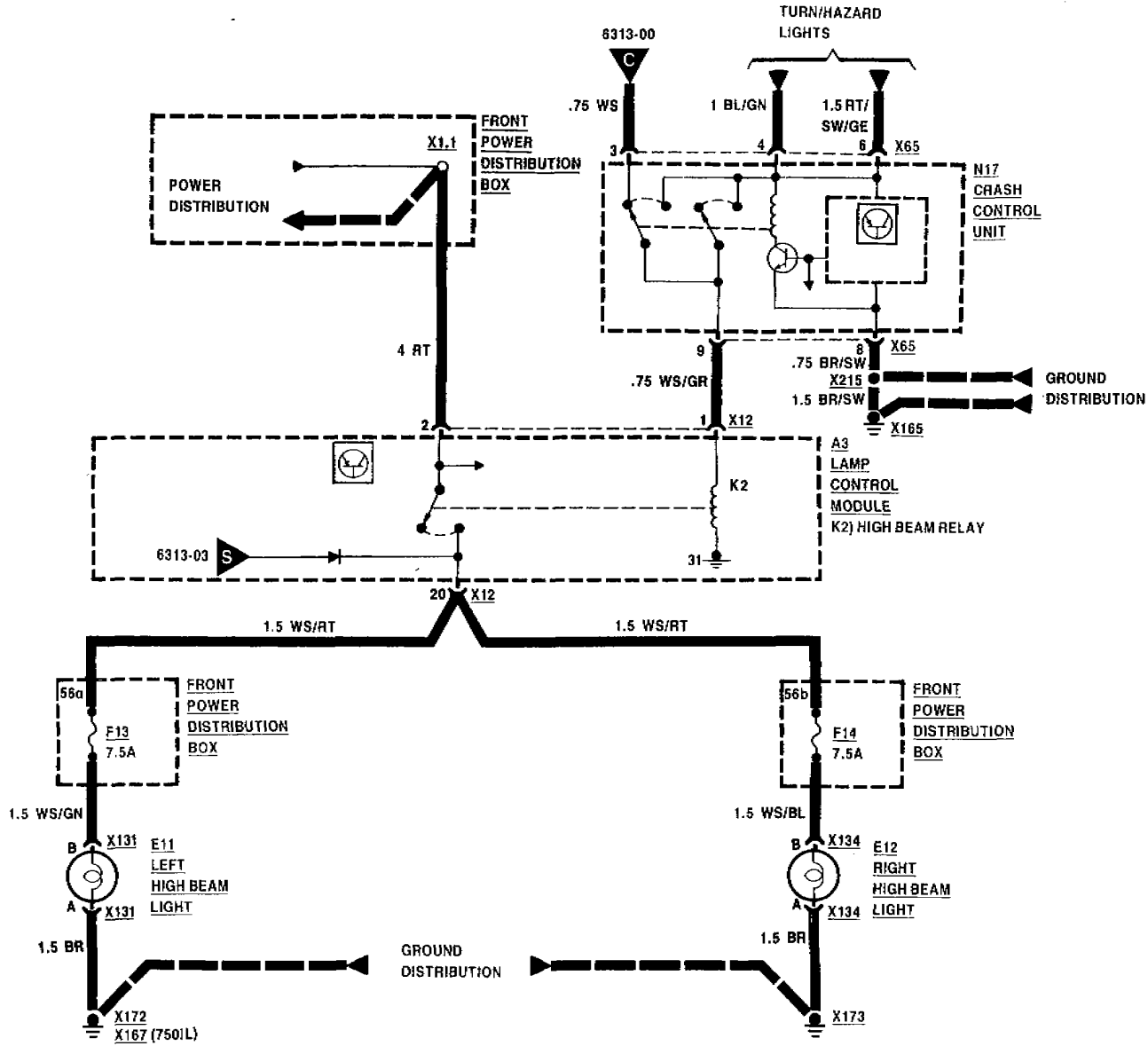

HEADLIGHTS/FOG LIGHTS

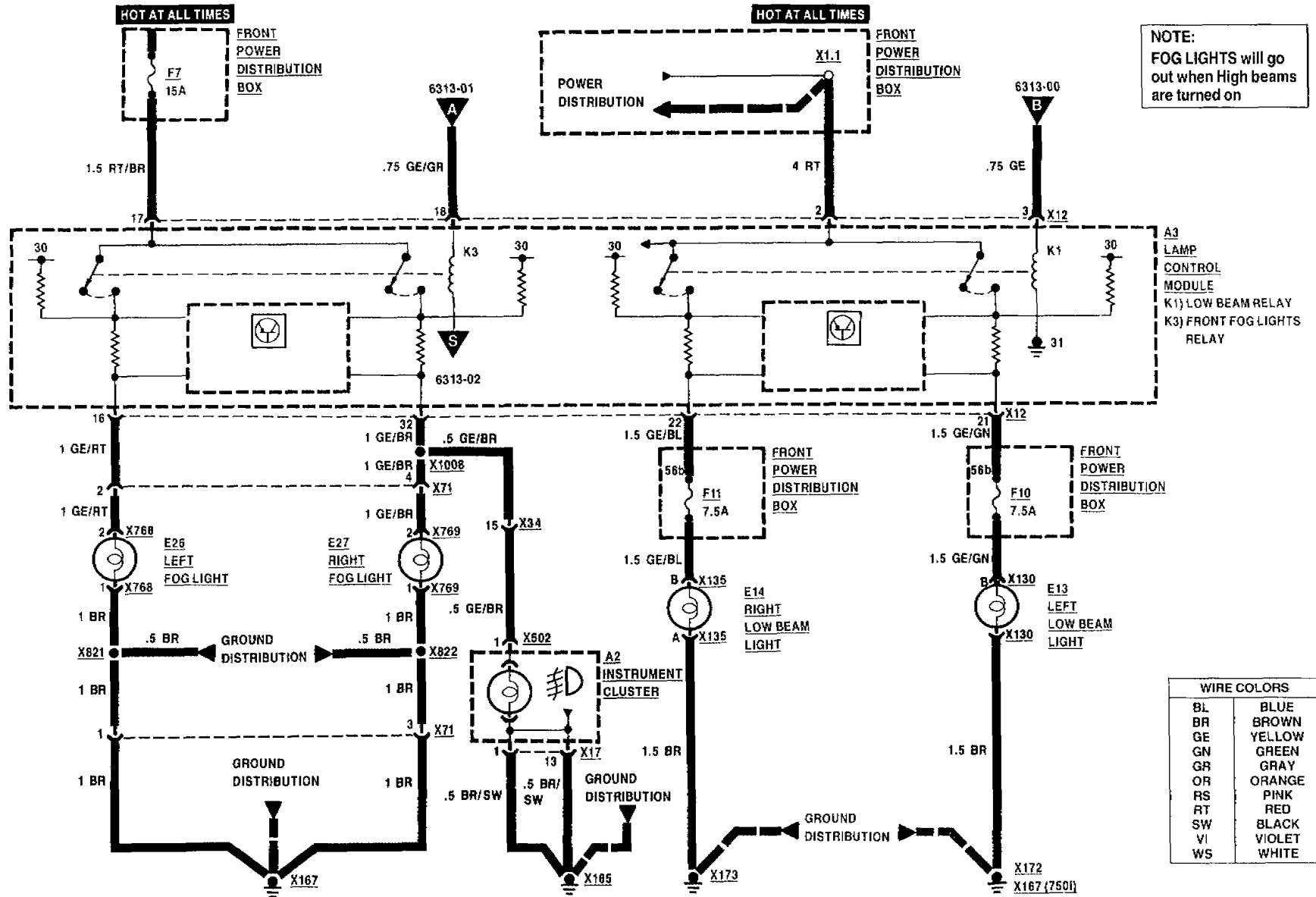



PARK/TAIL/MARKER/UNDERHOOD LIGHTS

WIRE COLORS	
BL	BLUE
BR	BROWN
GE	YELLOW
GN	GREEN
GR	GRAY
OR	ORANGE
RS	PINK
RT	RED
SW	BLACK
VI	VIOLET
WS	WHITE

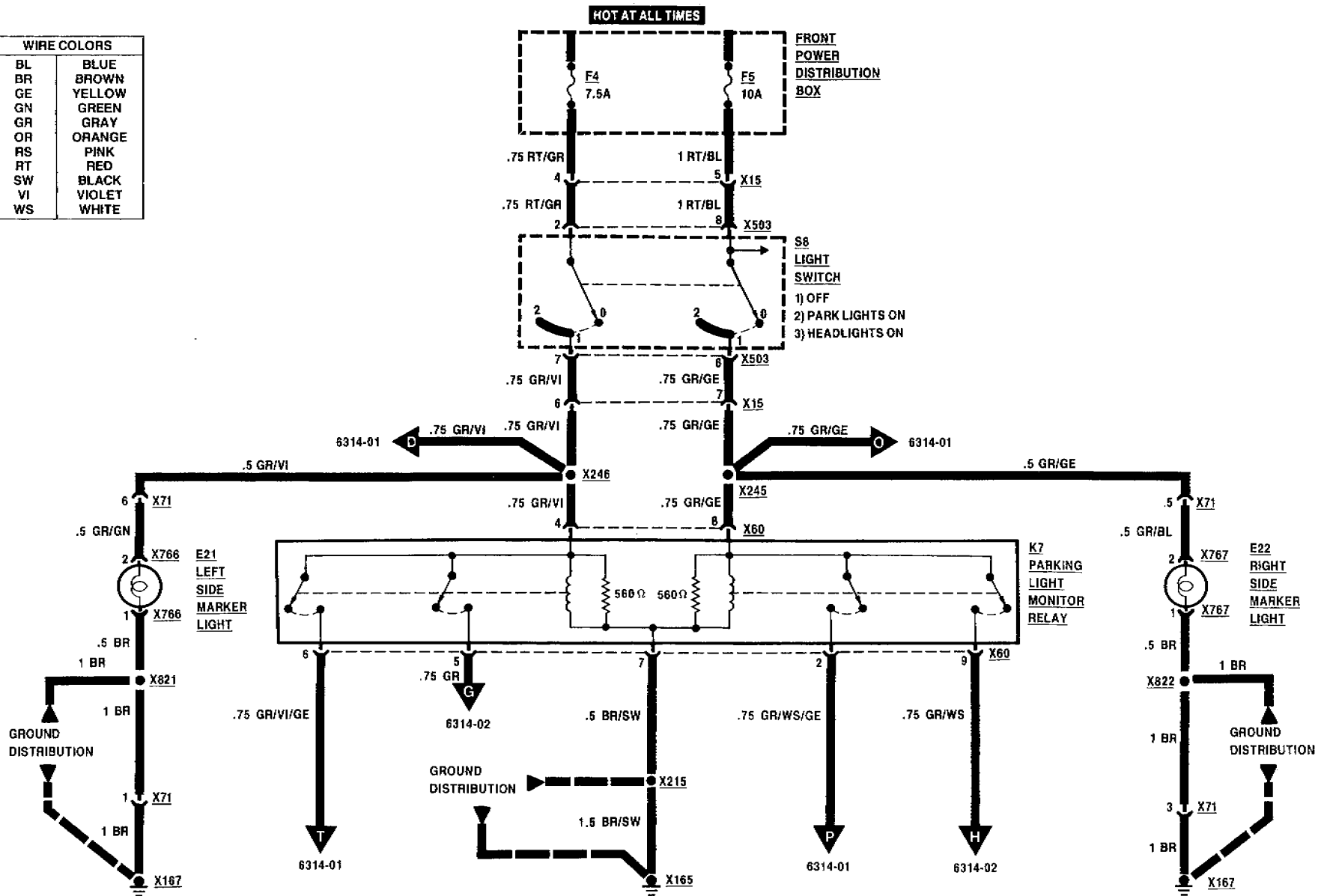



PARK/TAIL/MARKER/UNDERHOOD LIGHTS

REAR PARK LIGHTS

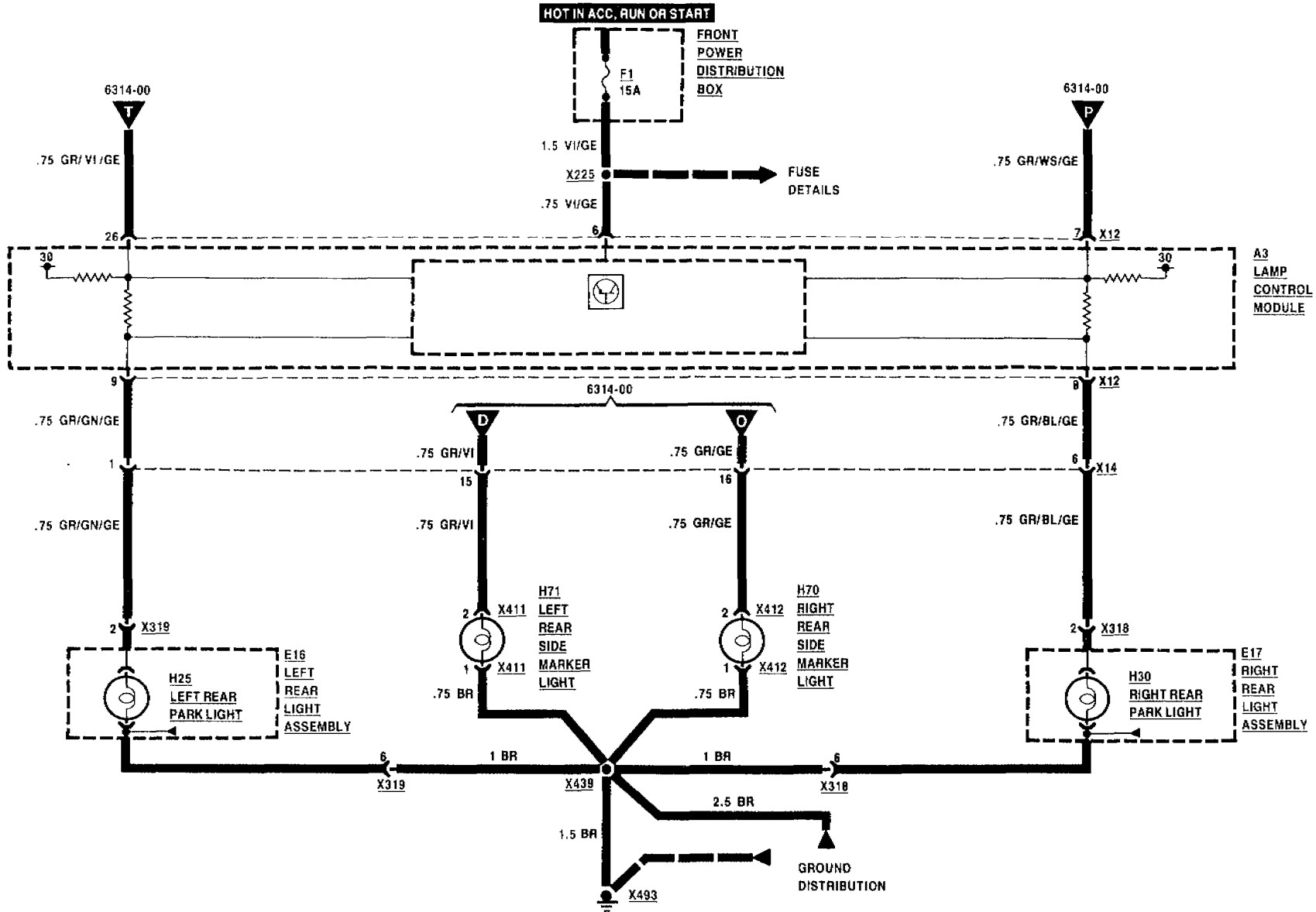



PARK/TAIL/MARKER/UNDERHOOD LIGHTS

PARK/FRONT MARKER LIGHTS

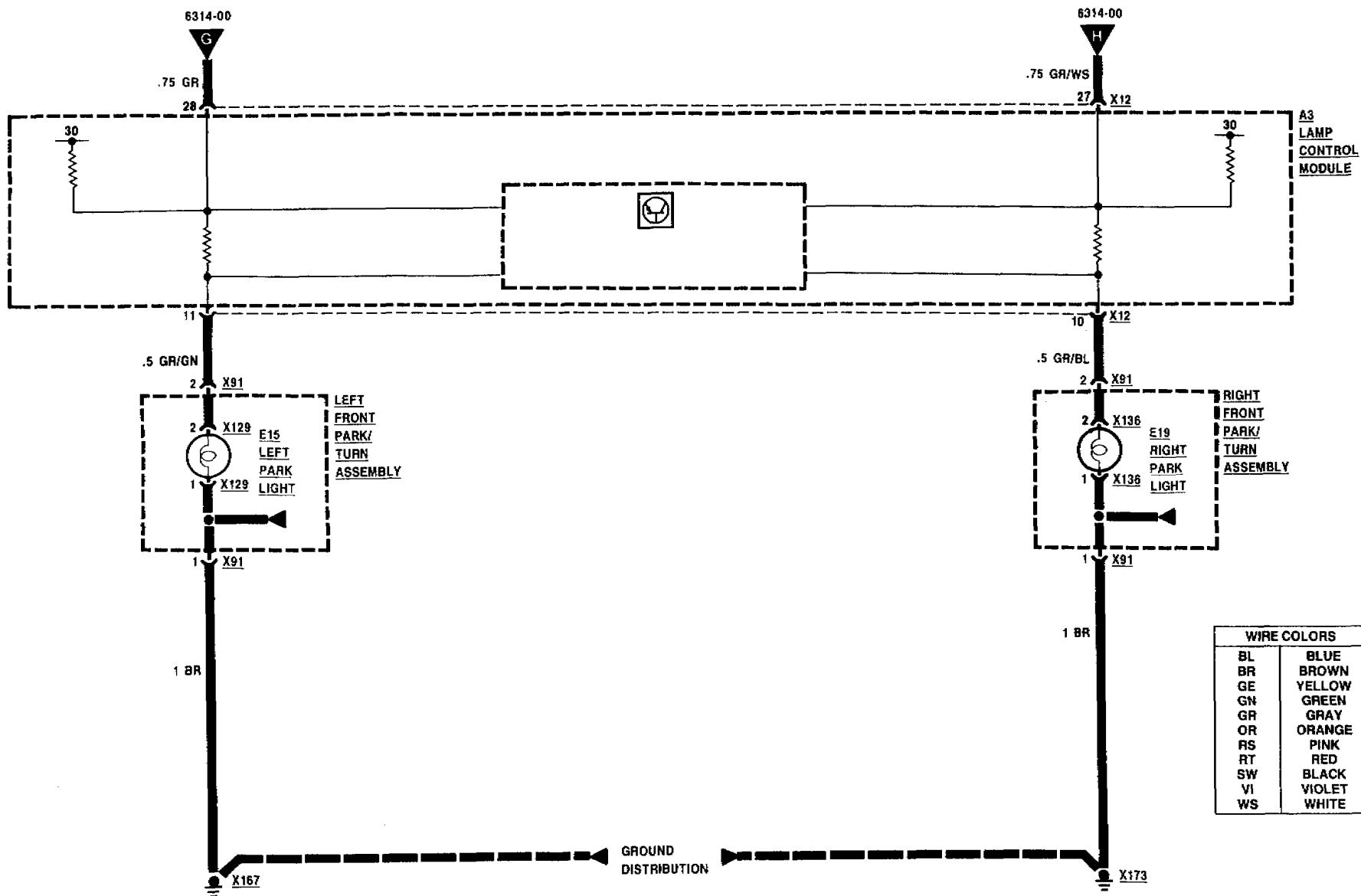



PARK/TAIL/MARKER/UNDERHOOD LIGHTS

UNDERHOOD LIGHT

WIRE COLORS	
BL	BLUE
BR	BROWN
GE	YELLOW
GN	GREEN
GR	GRAY
OR	ORANGE
RS	PINK
RT	RED
SW	BLACK
VI	VIOLET
WS	WHITE

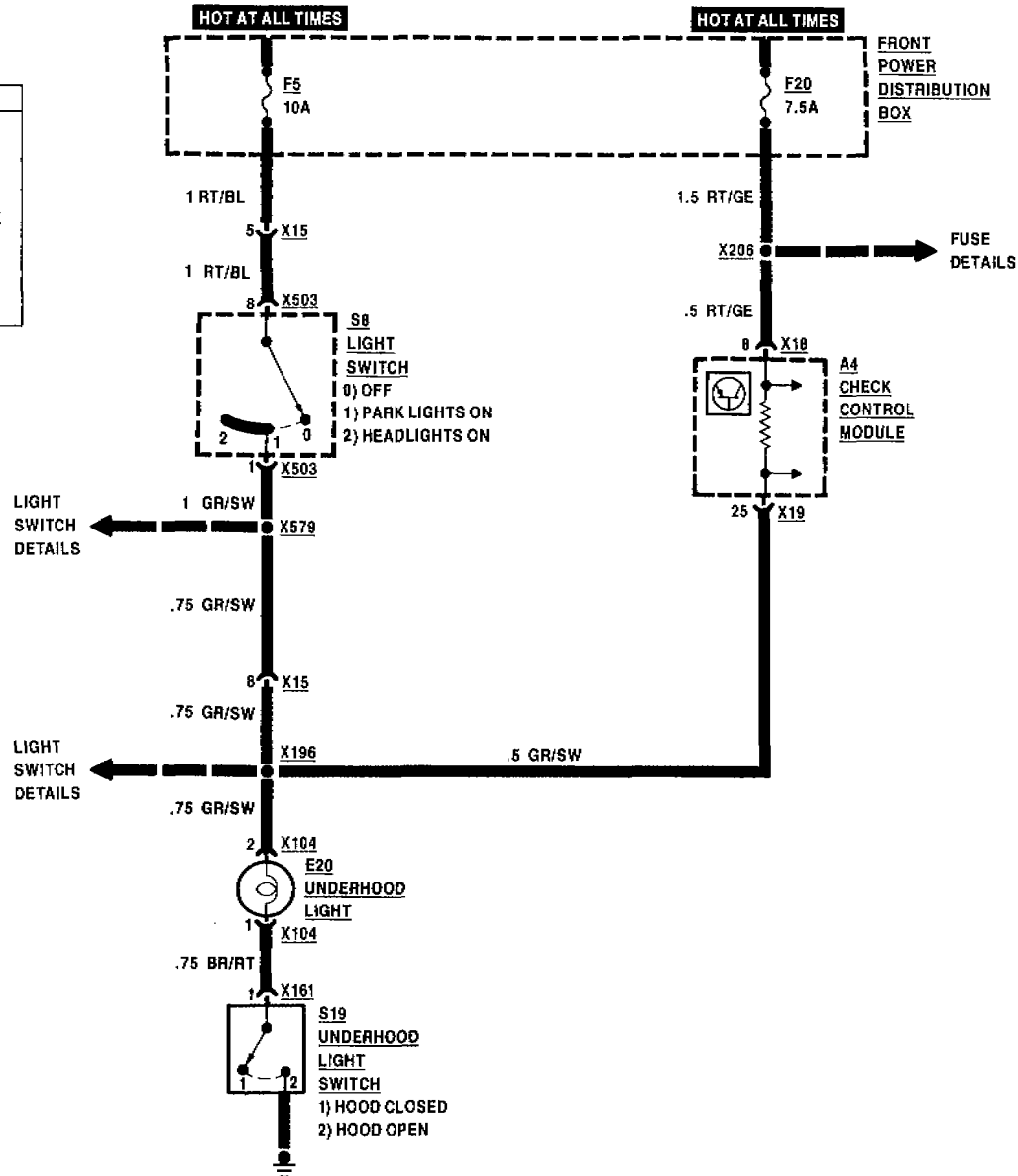



LICENSE/TRUNK LIGHTS

LICENSE LIGHTS

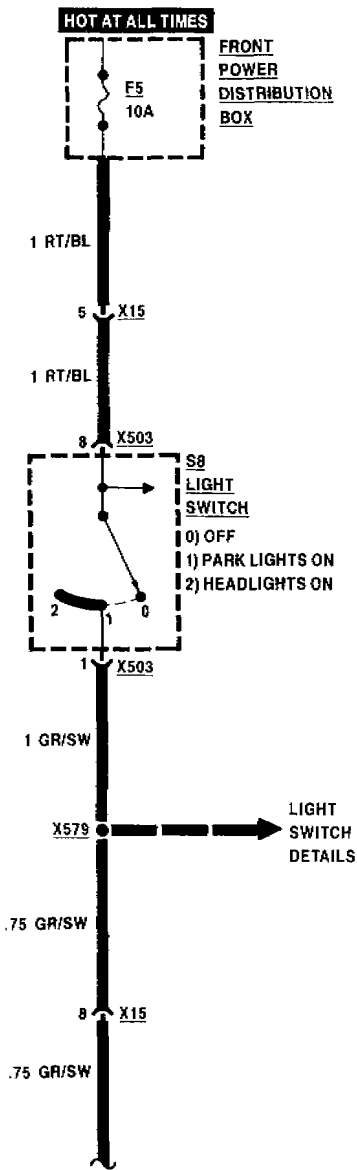

WIRE COLORS	
BL	BLUE
BR	BROWN
GE	YELLOW
GN	GREEN
GR	GRAY
OR	ORANGE
RS	PINK
RT	RED
SW	BLACK
VI	VIOLET
WS	WHITE

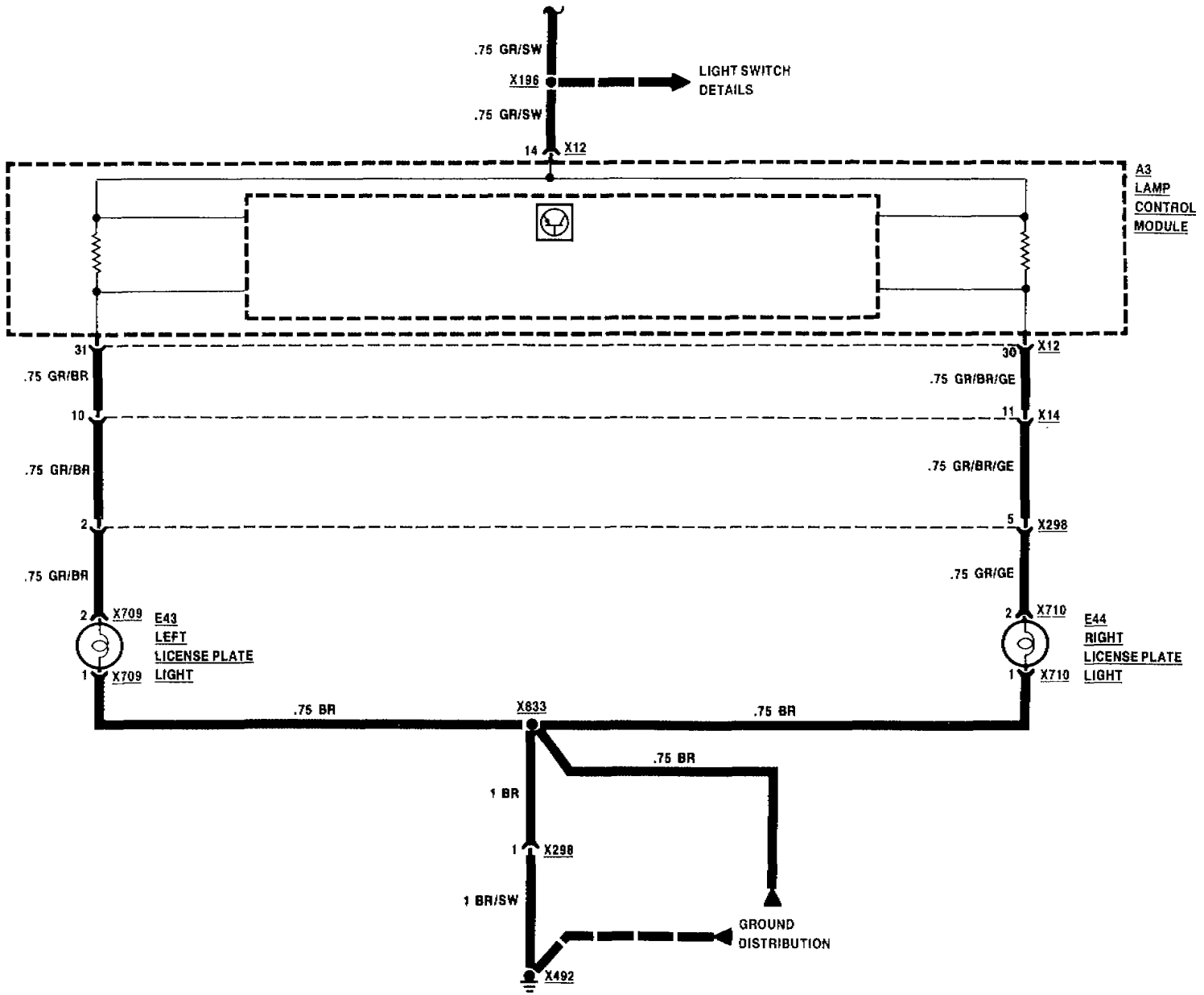



LICENSE/TRUNK LIGHTS

TRUNK LIGHTS

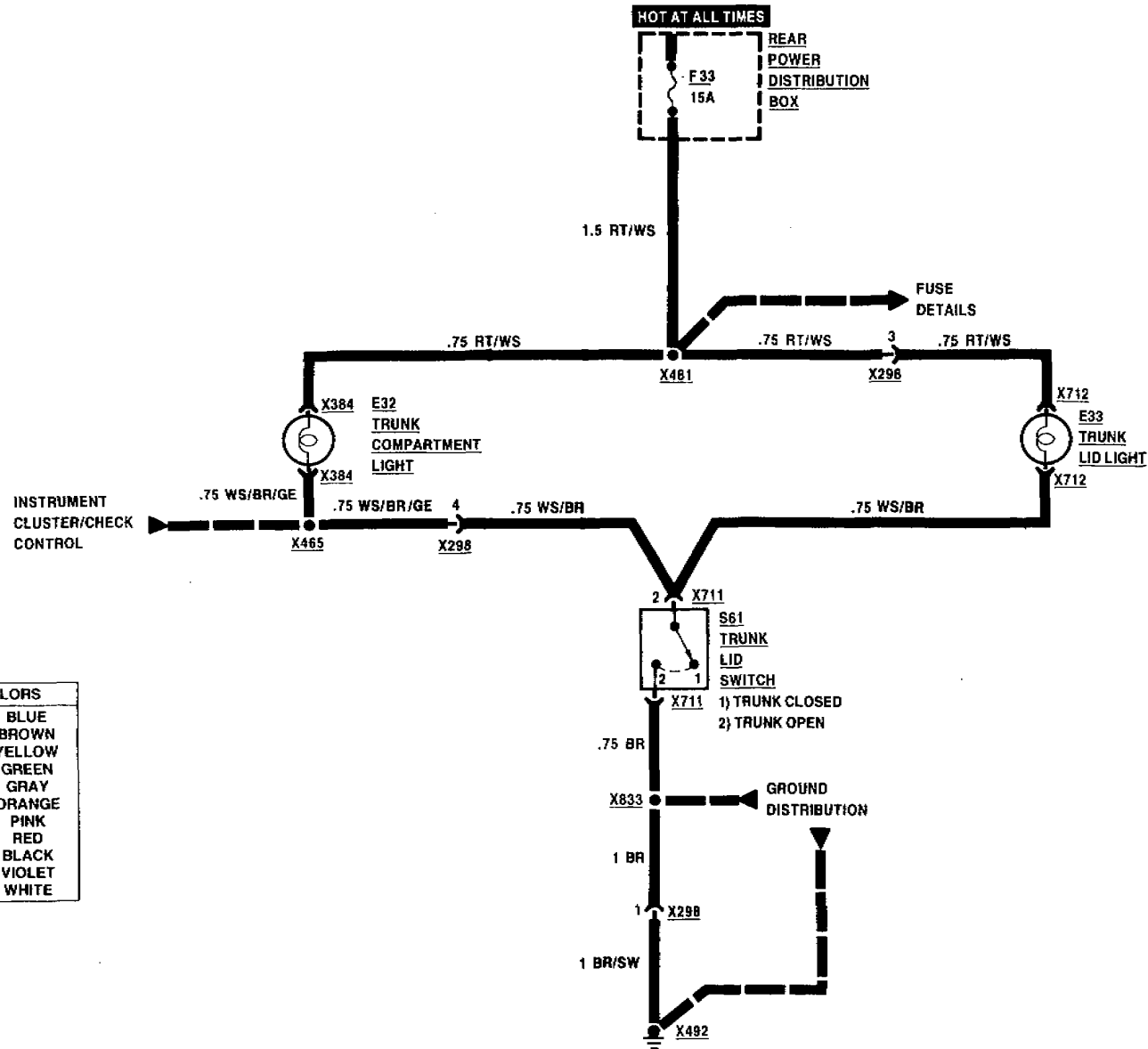

WIRE COLORS	
BL	BLUE
BR	BROWN
GE	YELLOW
GN	GREEN
GR	GRAY
OR	ORANGE
RS	PINK
RT	RED
SW	BLACK
VI	VIOLET
WS	WHITE

BACK UP LIGHTS

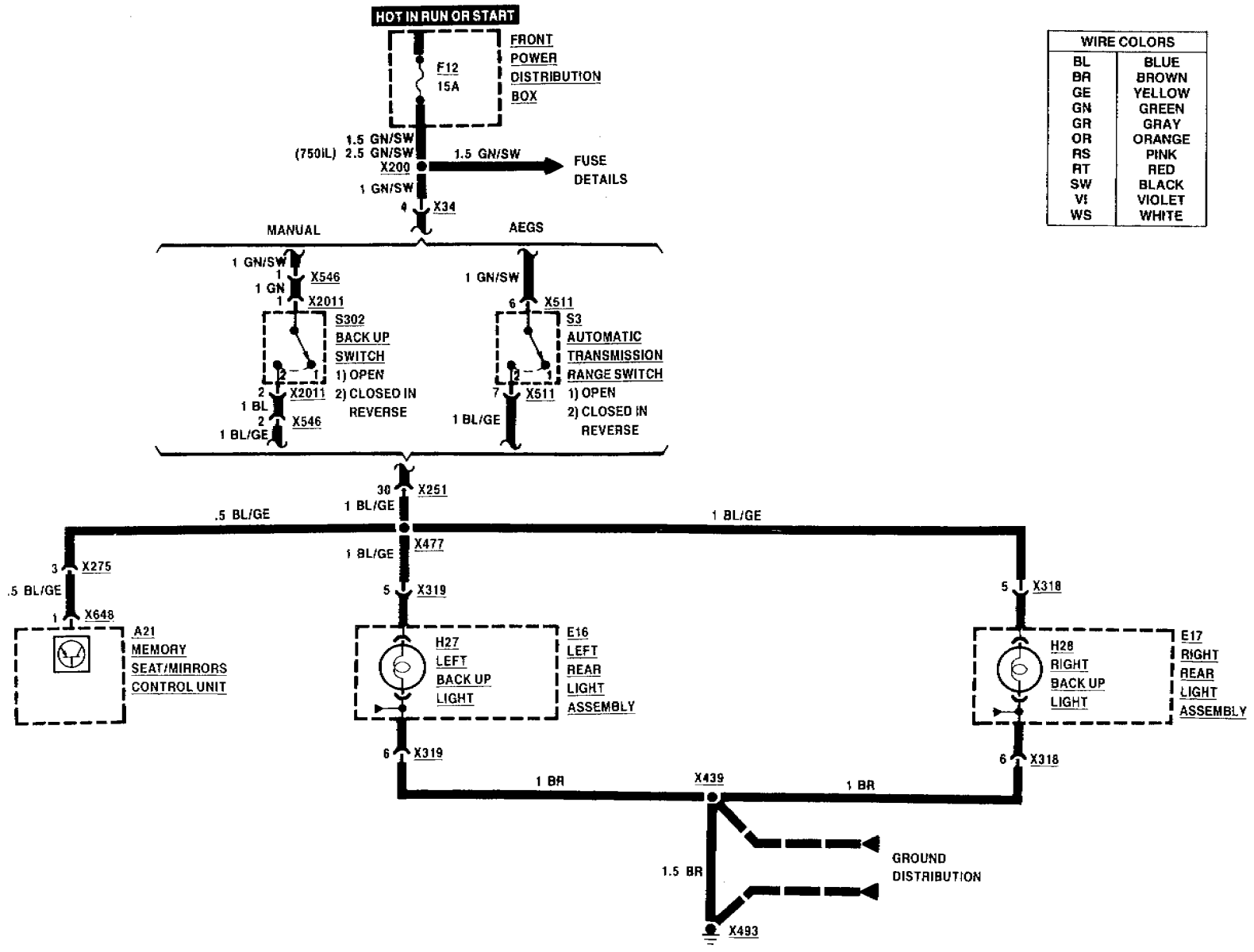

WIRE COLORS	
BL	BLUE
BR	BROWN
GE	YELLOW
GN	GREEN
GR	GRAY
OR	ORANGE
RS	PINK
RT	RED
SW	BLACK
VI	VIOLET
WS	WHITE

BRAKE LIGHTS

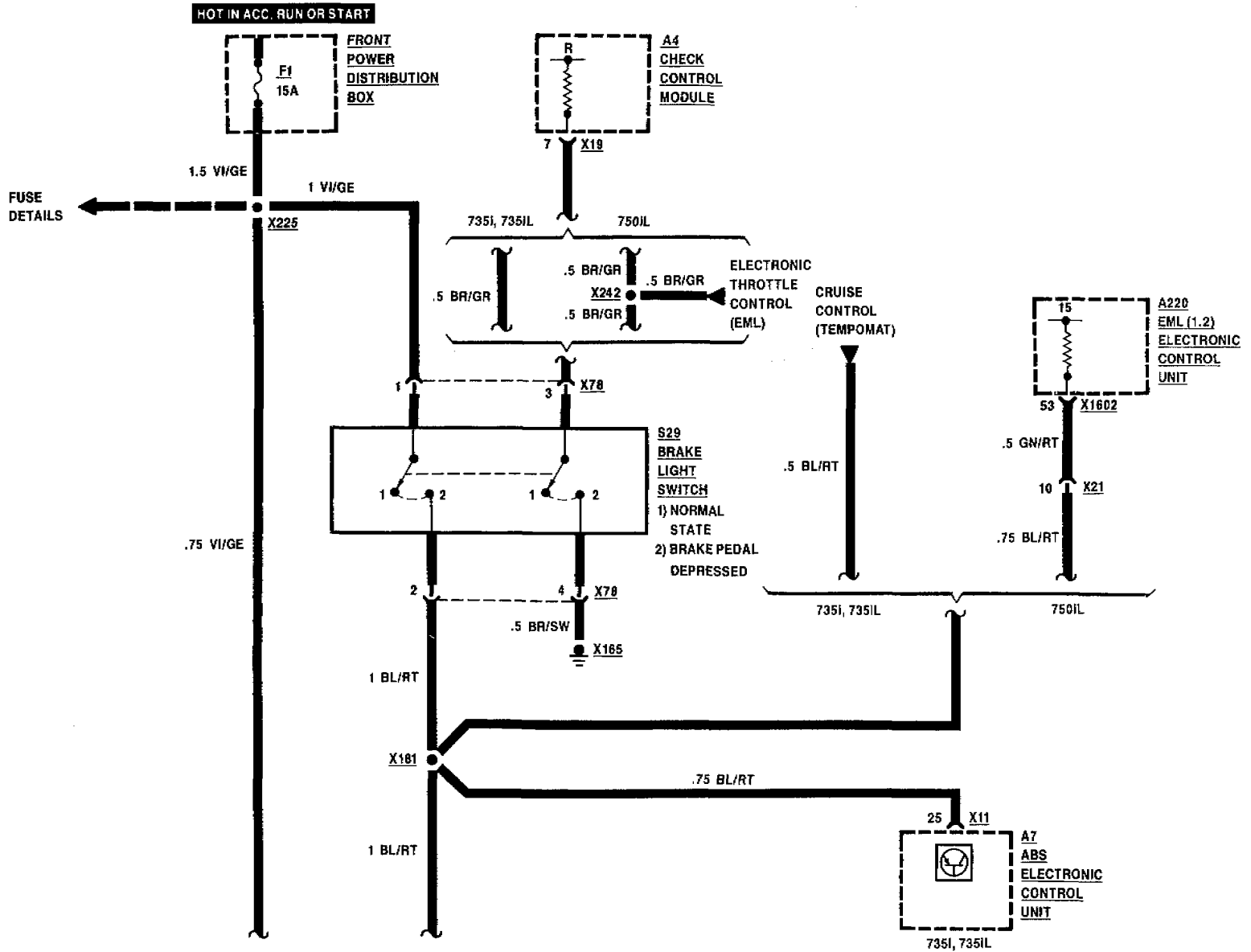



INTERIOR LIGHTS (ZKE)

INPUT DETAILS

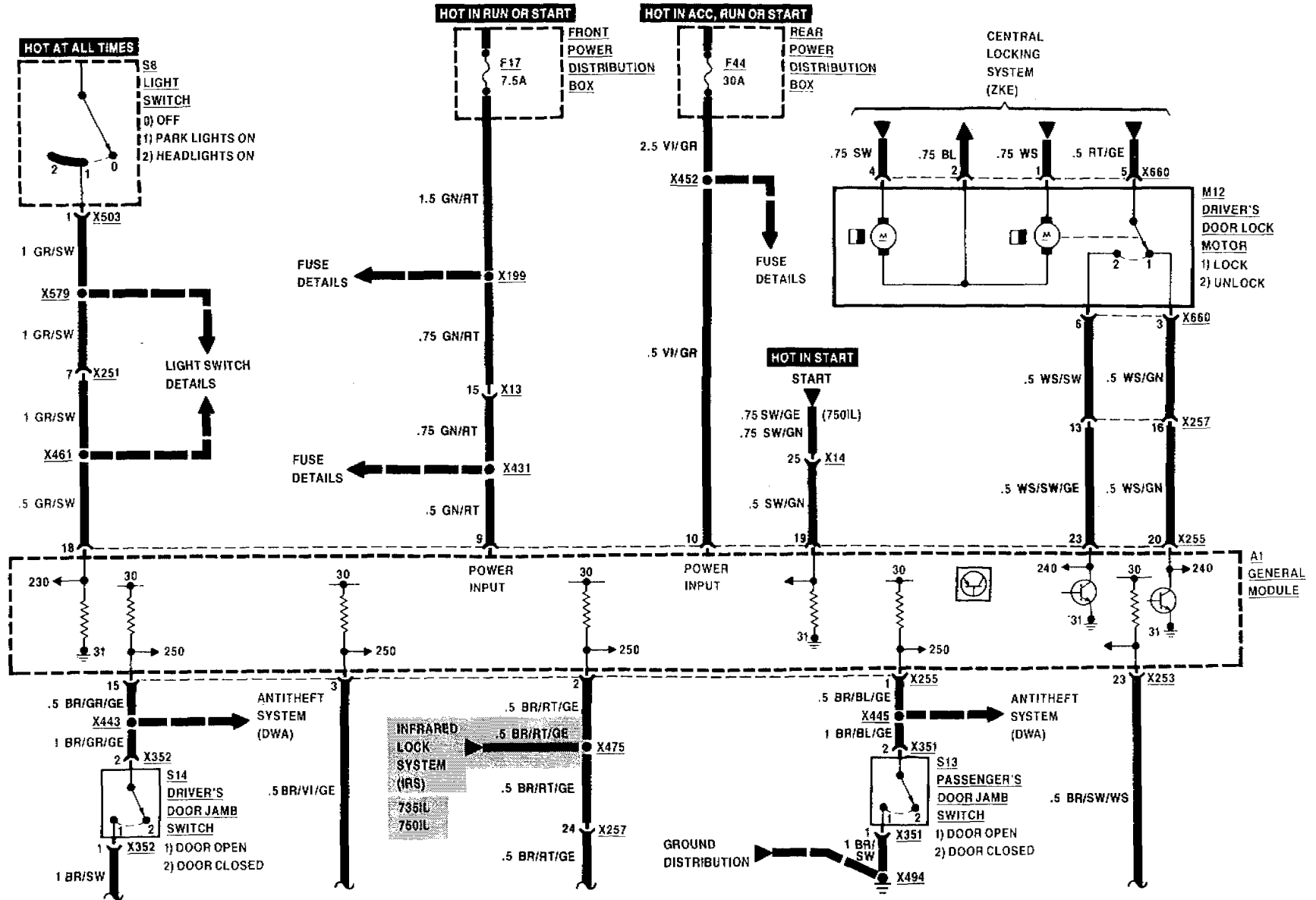

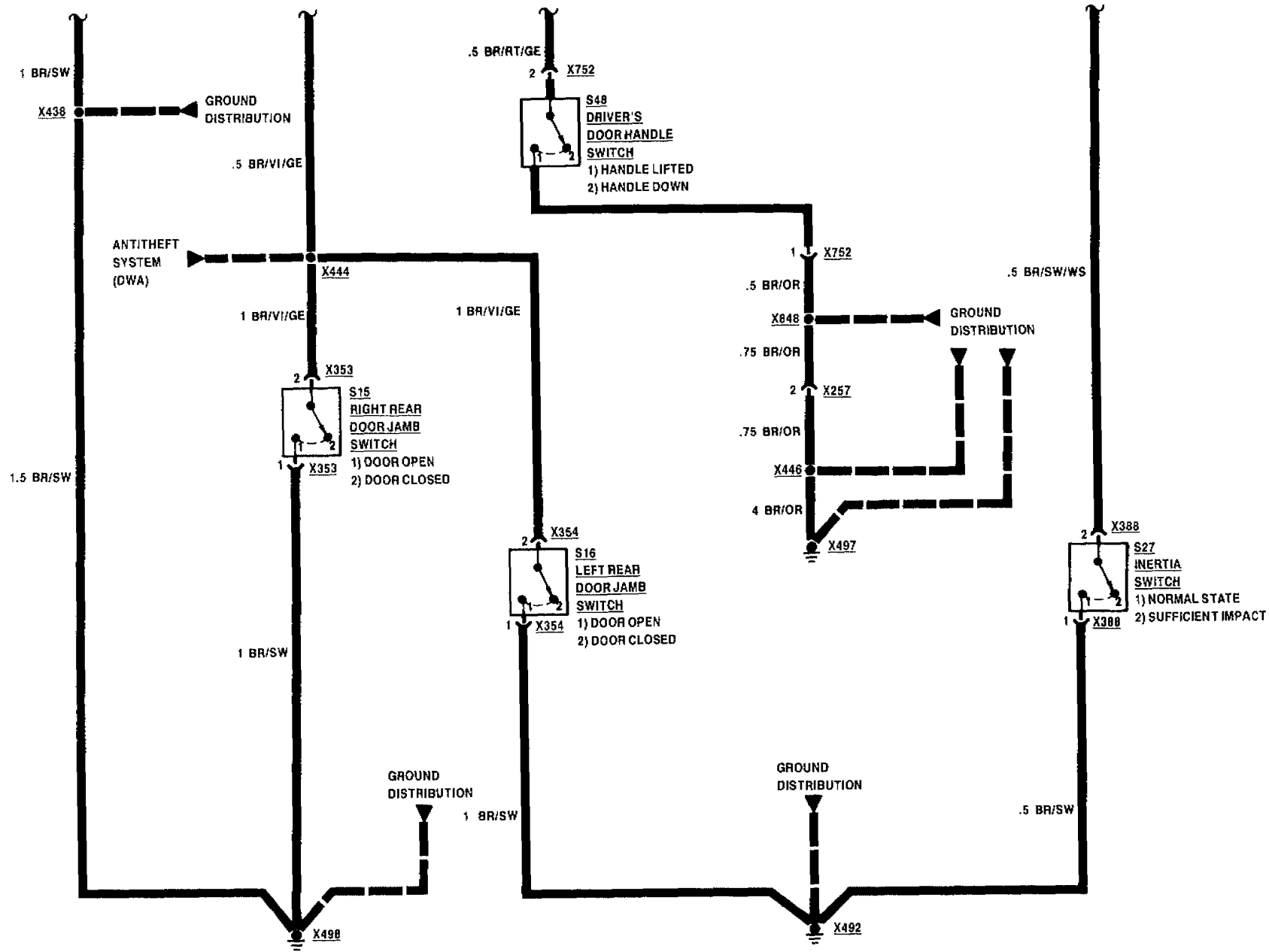



INTERIOR LIGHTS (ZKE) OUTPUT DETAILS

WIRE COLORS	
BL	BLUE
BR	BROWN
GE	YELLOW
GN	GREEN
GR	GRAY
OR	ORANGE
RS	PINK
RT	RED
SW	BLACK
VI	VIOLET
WS	WHITE

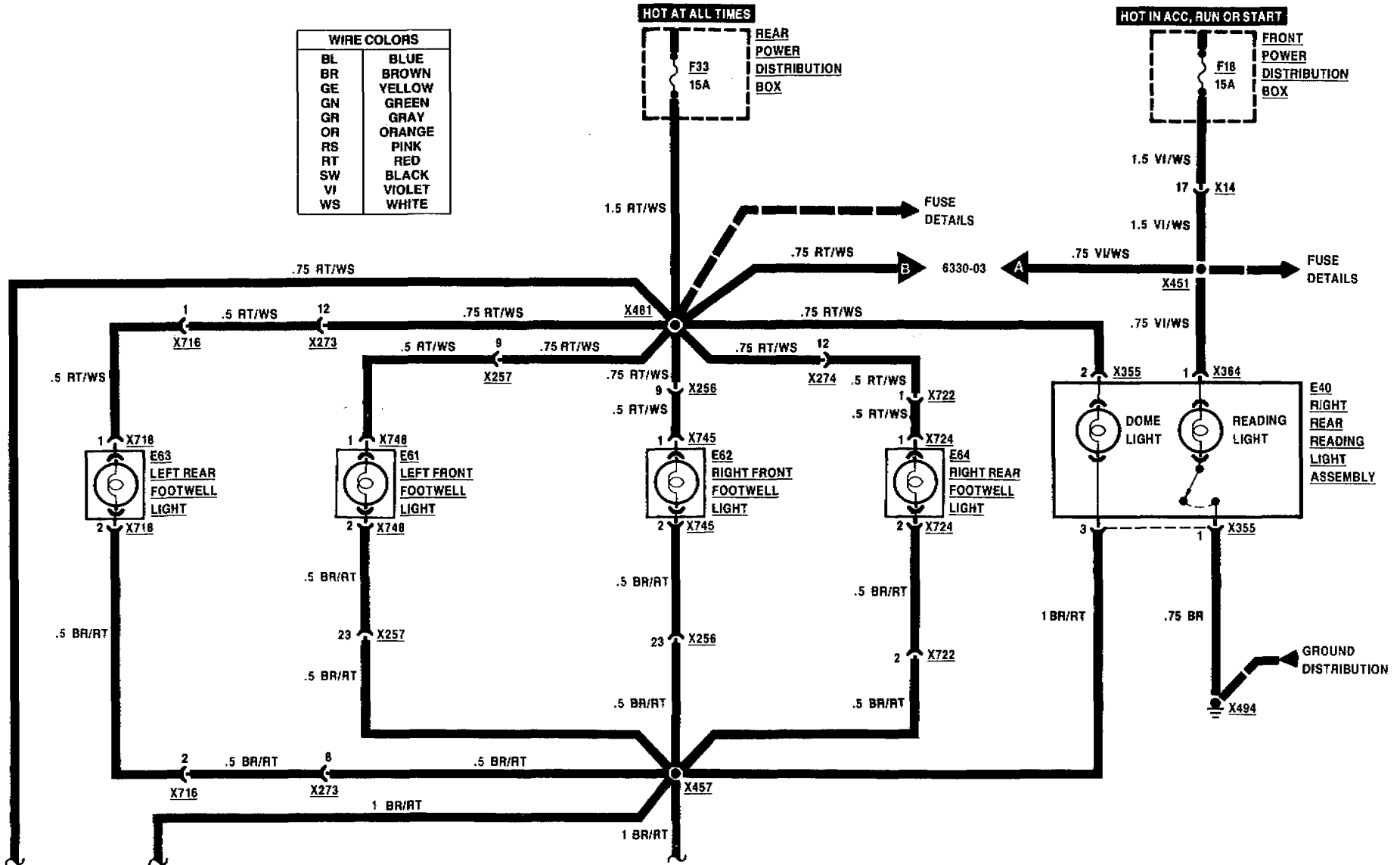

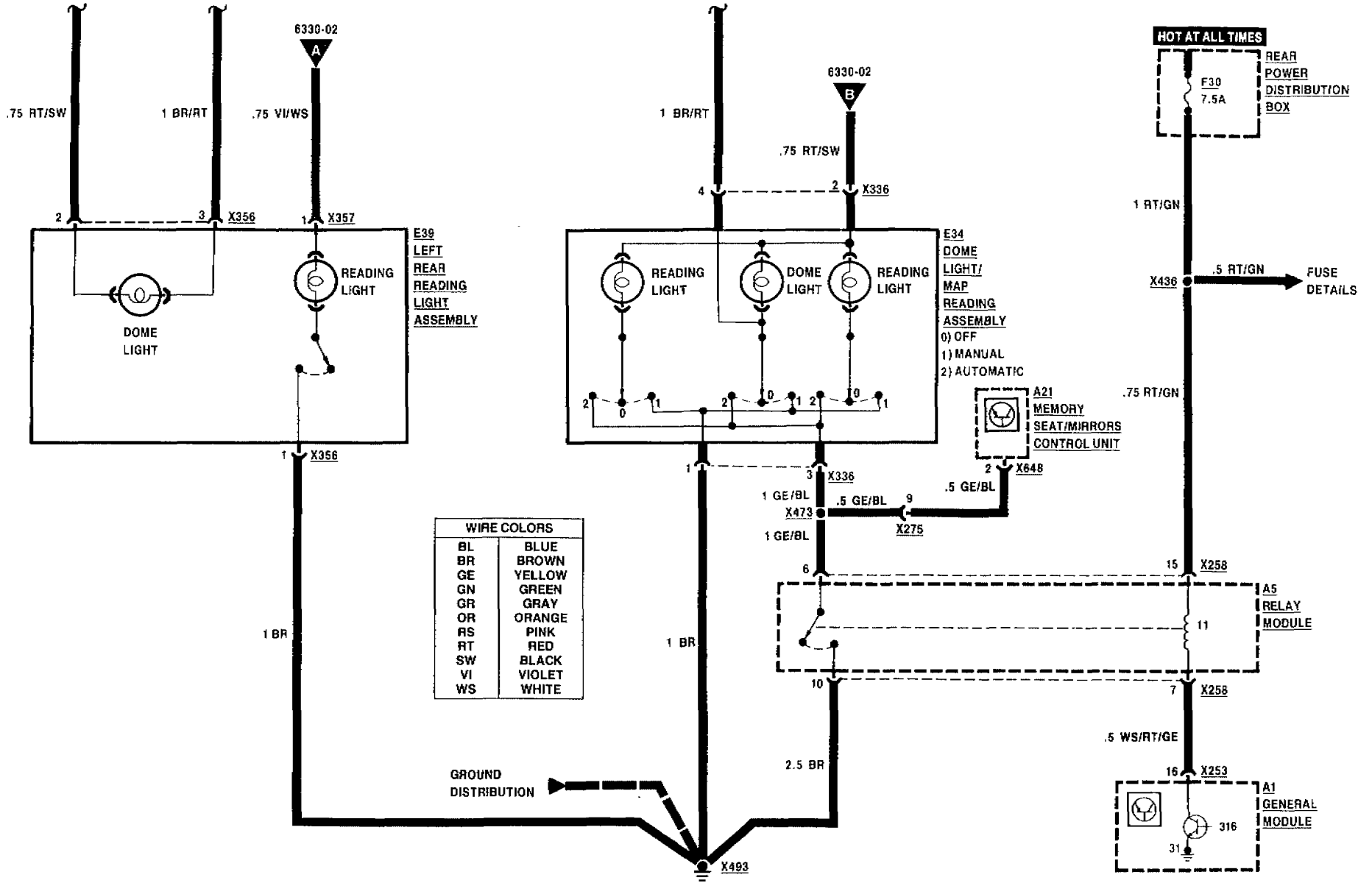



GLOVE BOX LIGHT/CIGAR LIGHTER/ASHTRAY LIGHT/CHARGING PLUG

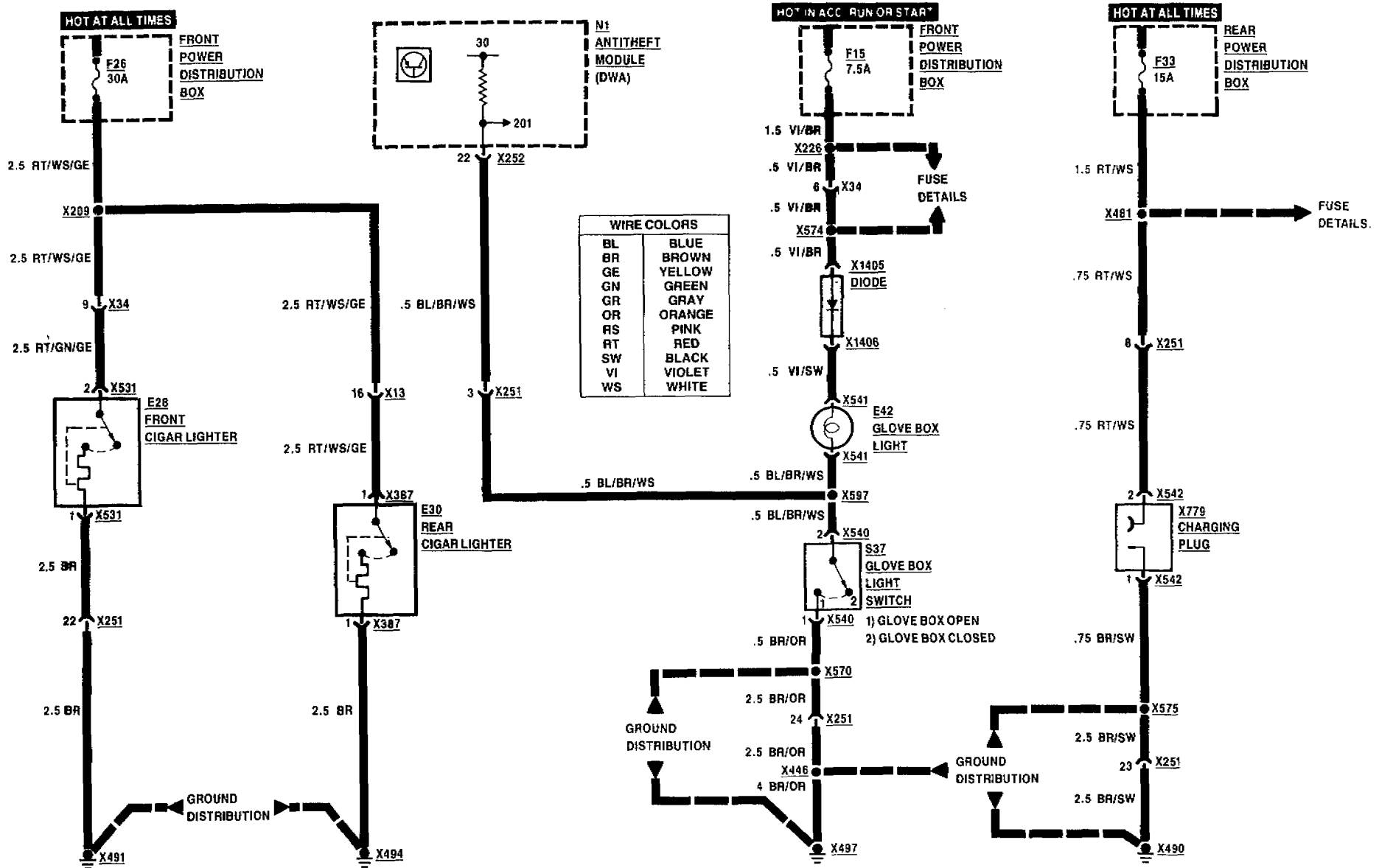



PARK VENTILATION

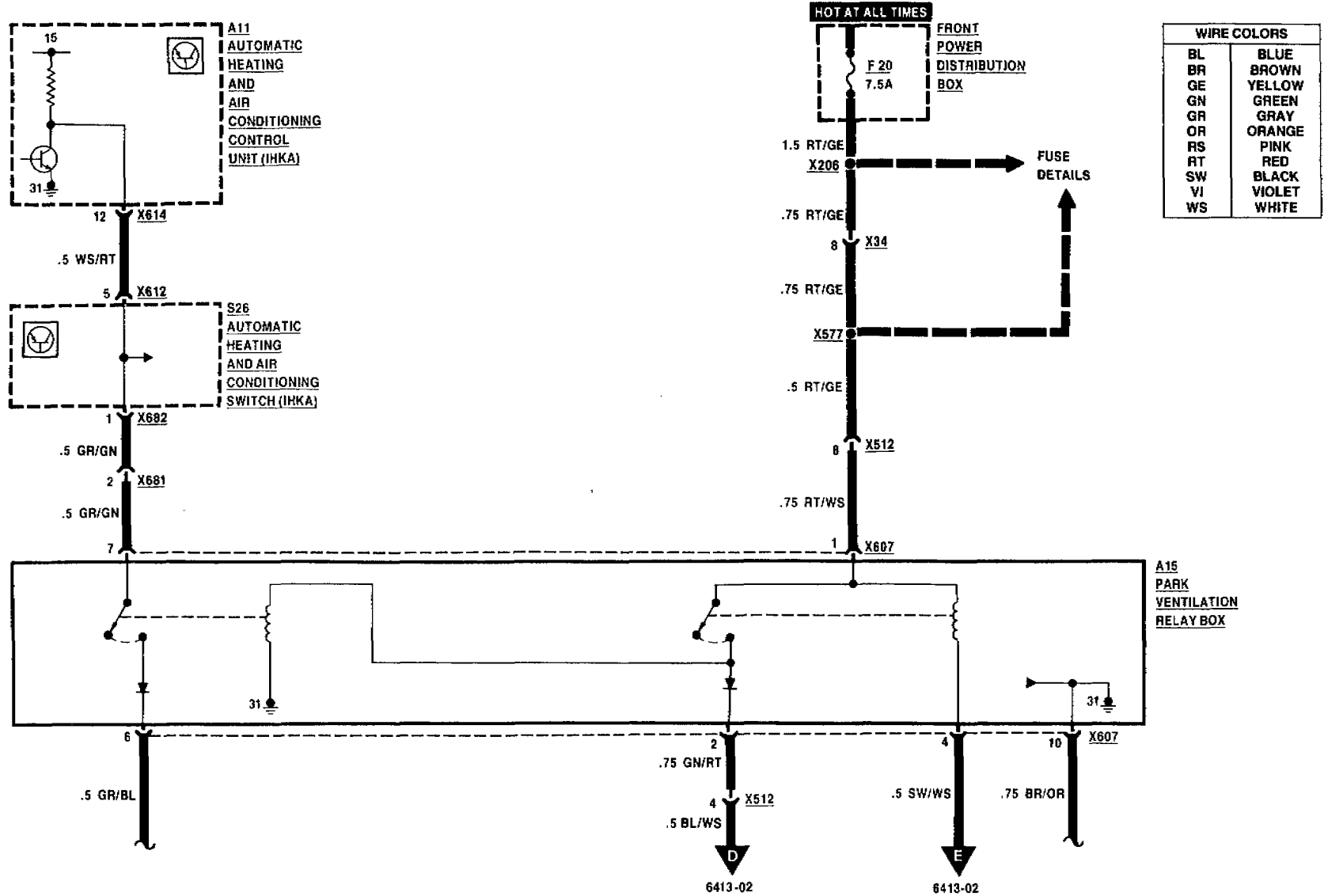

WIRE COLORS	
BL	BLUE
BR	BROWN
GE	YELLOW
GN	GREEN
GR	GRAY
OR	ORANGE
RS	PINK
RT	RED
SW	BLACK
VI	VIOLET
WS	WHITE

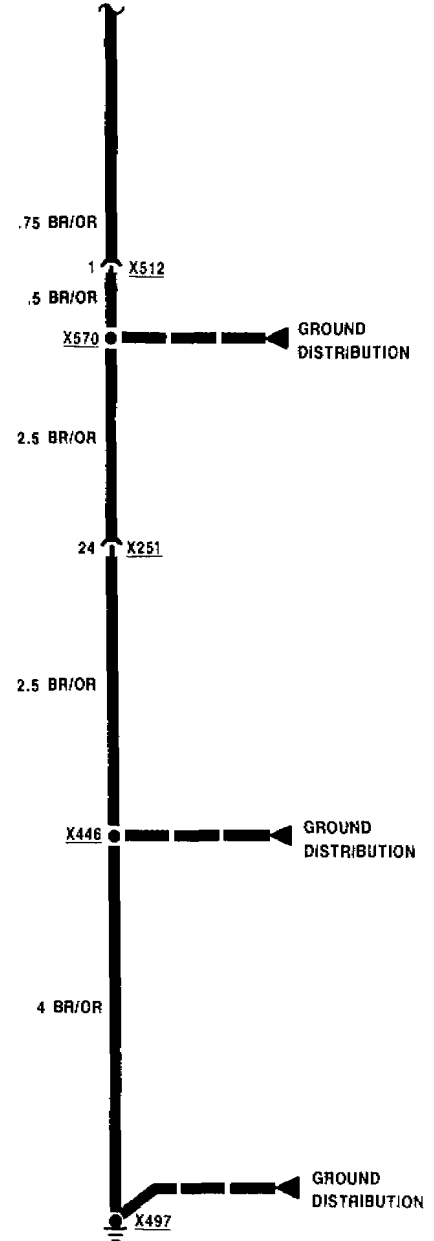
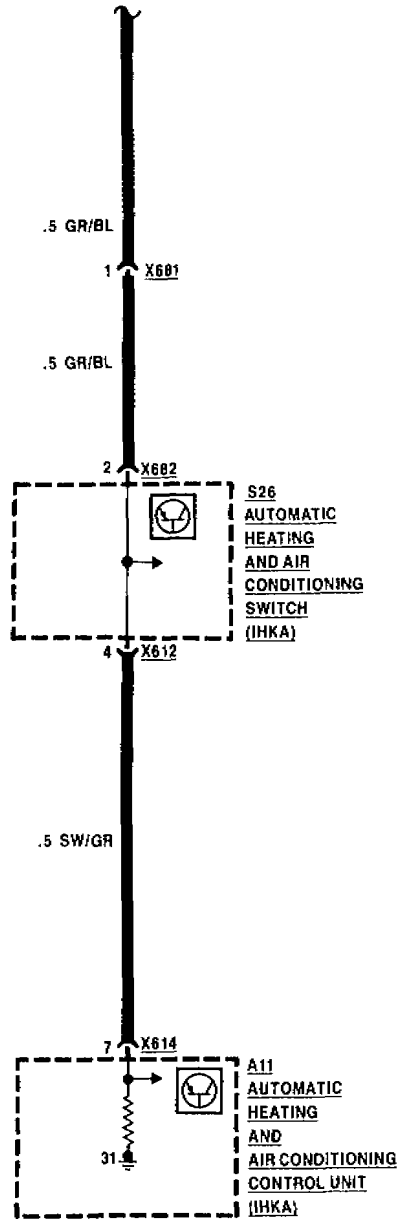



PARK VENTILATION

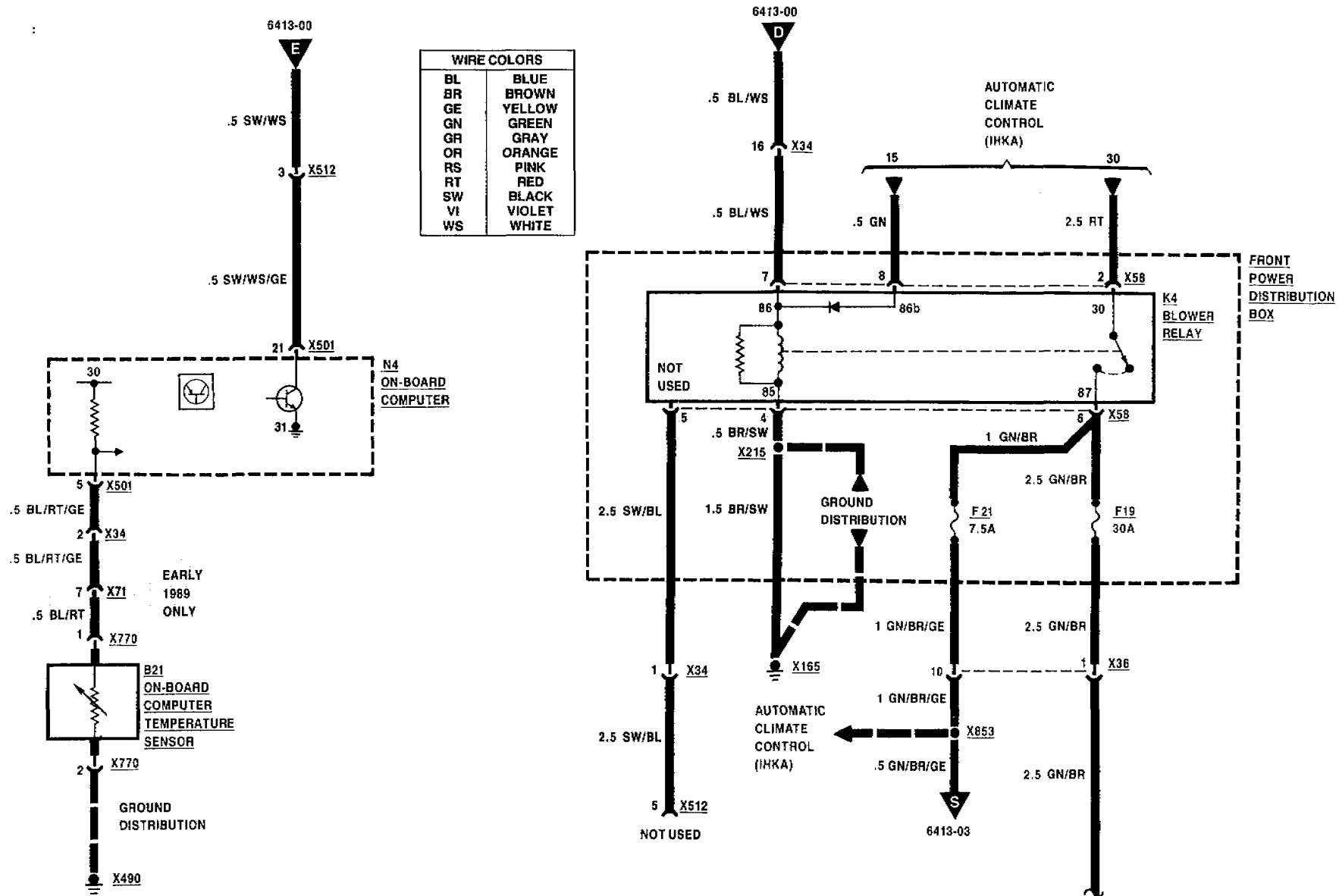

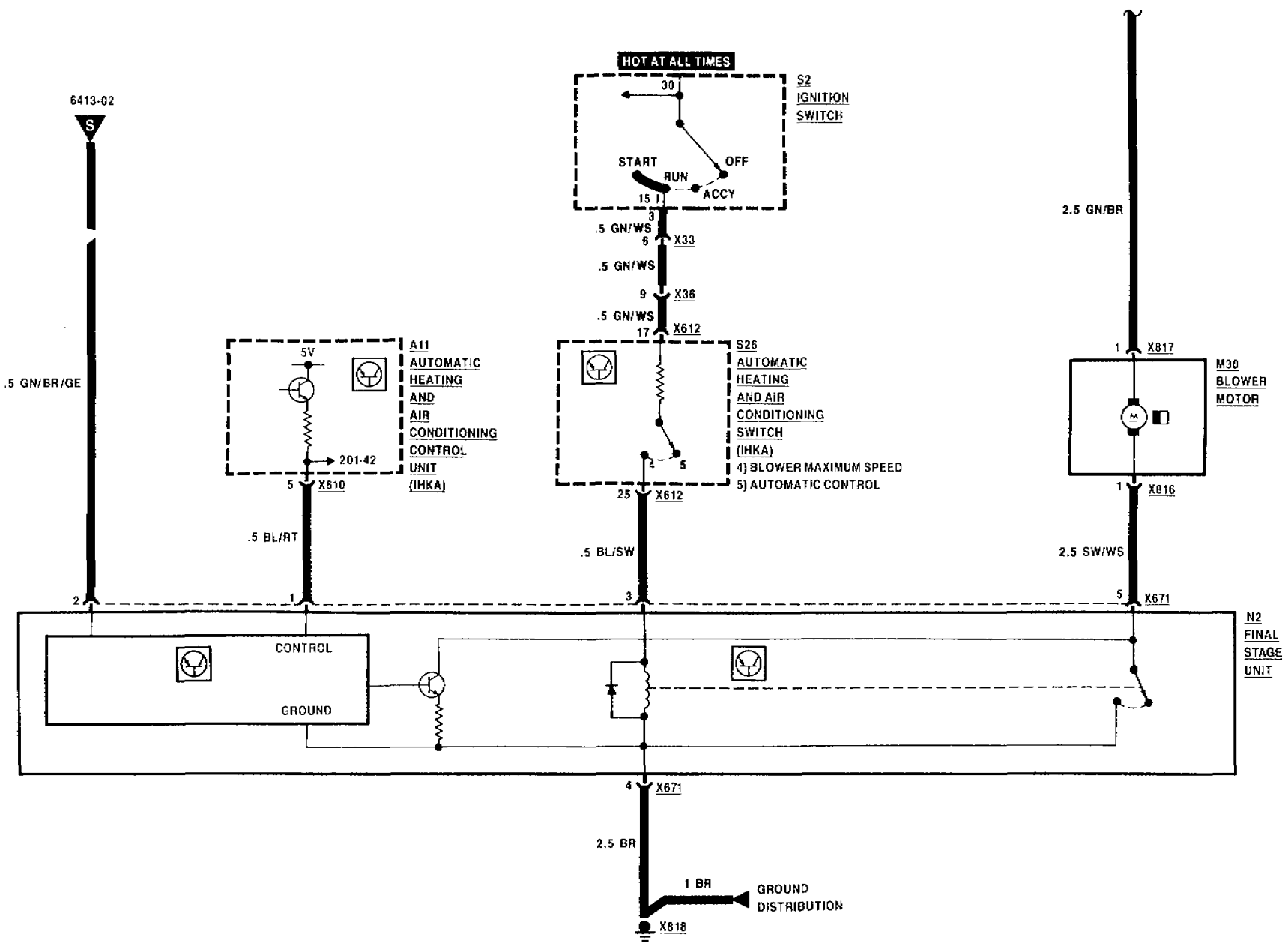



REAR WINDOW DEFOGGER

IHKA

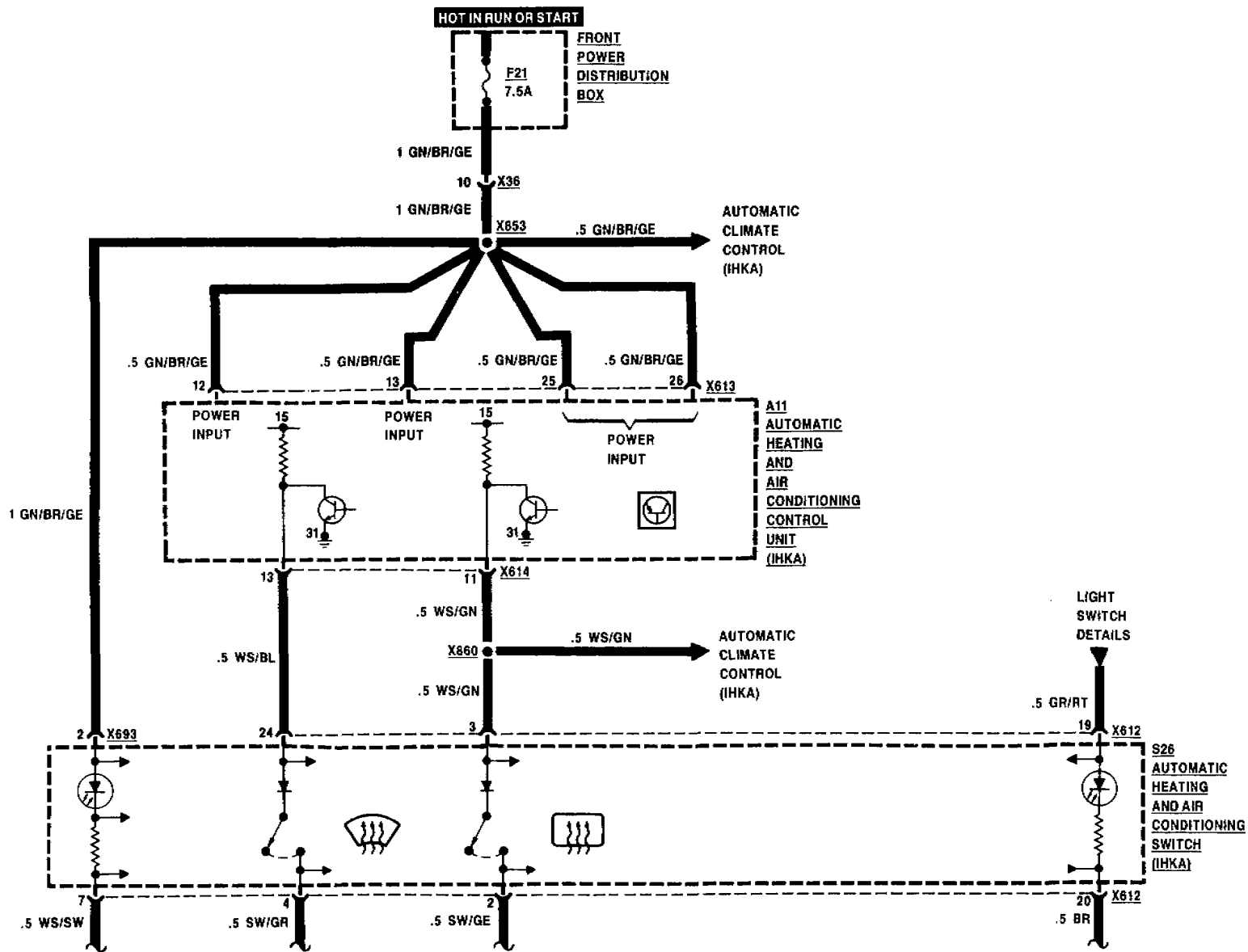

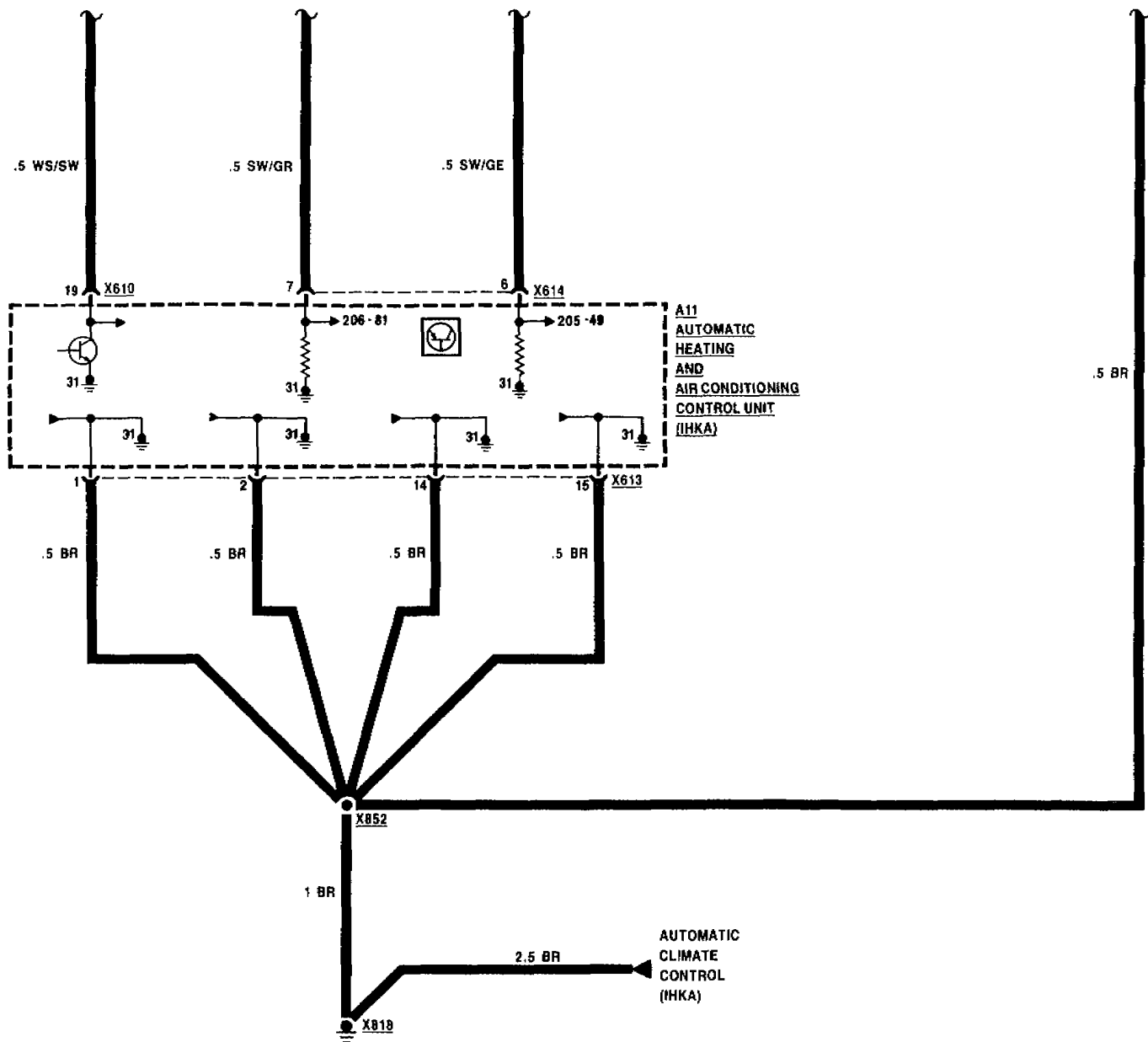

WIRE COLORS	
BL	BLUE
BR	BROWN
GE	YELLOW
GN	GREEN
GR	GRAY
OR	ORANGE
RS	PINK
RT	RED
SW	BLACK
VI	VIOLET
WS	WHITE

BMW
7 **AUTOMATIC CLIMATE CONTROL (IHKA)**
POWER

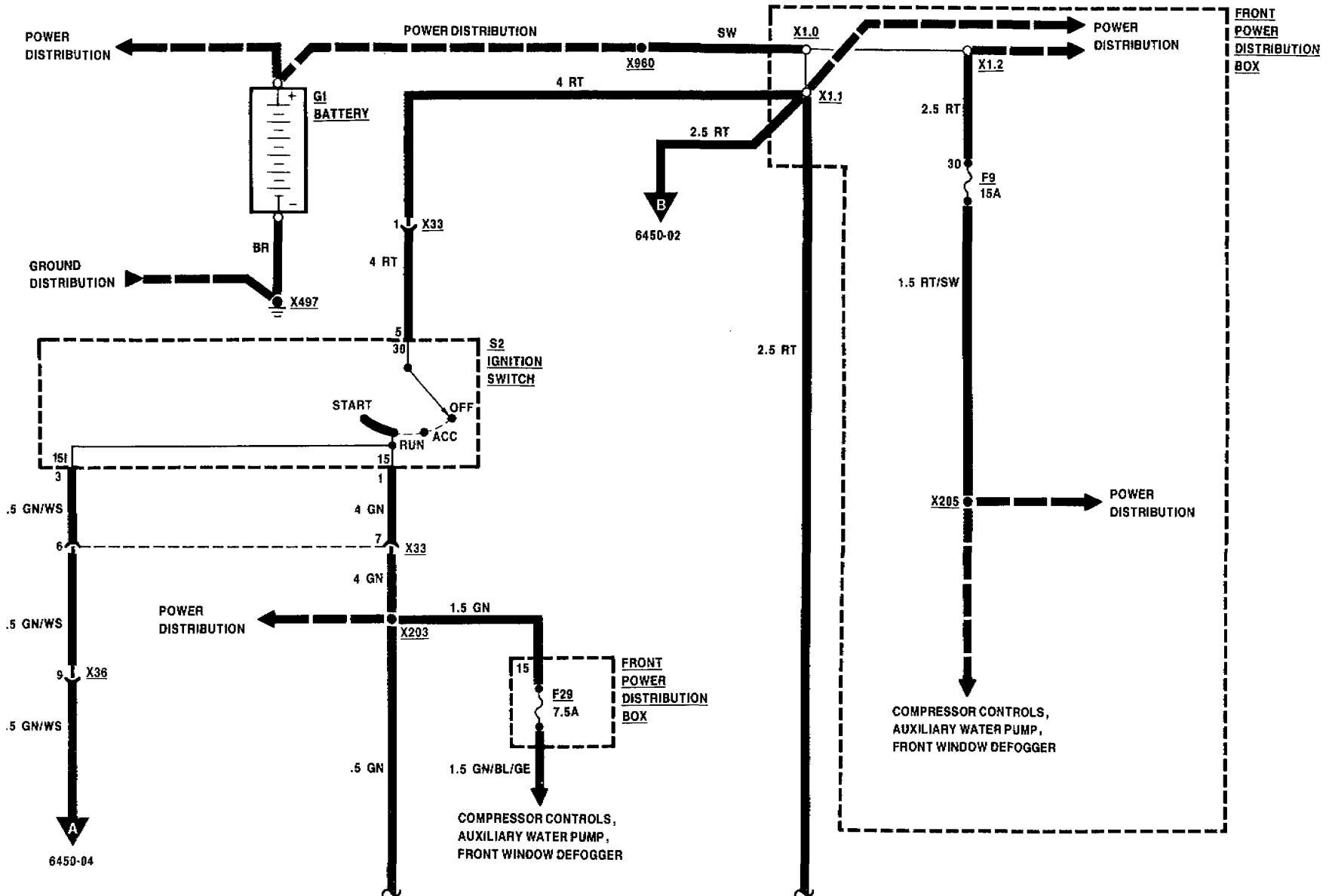

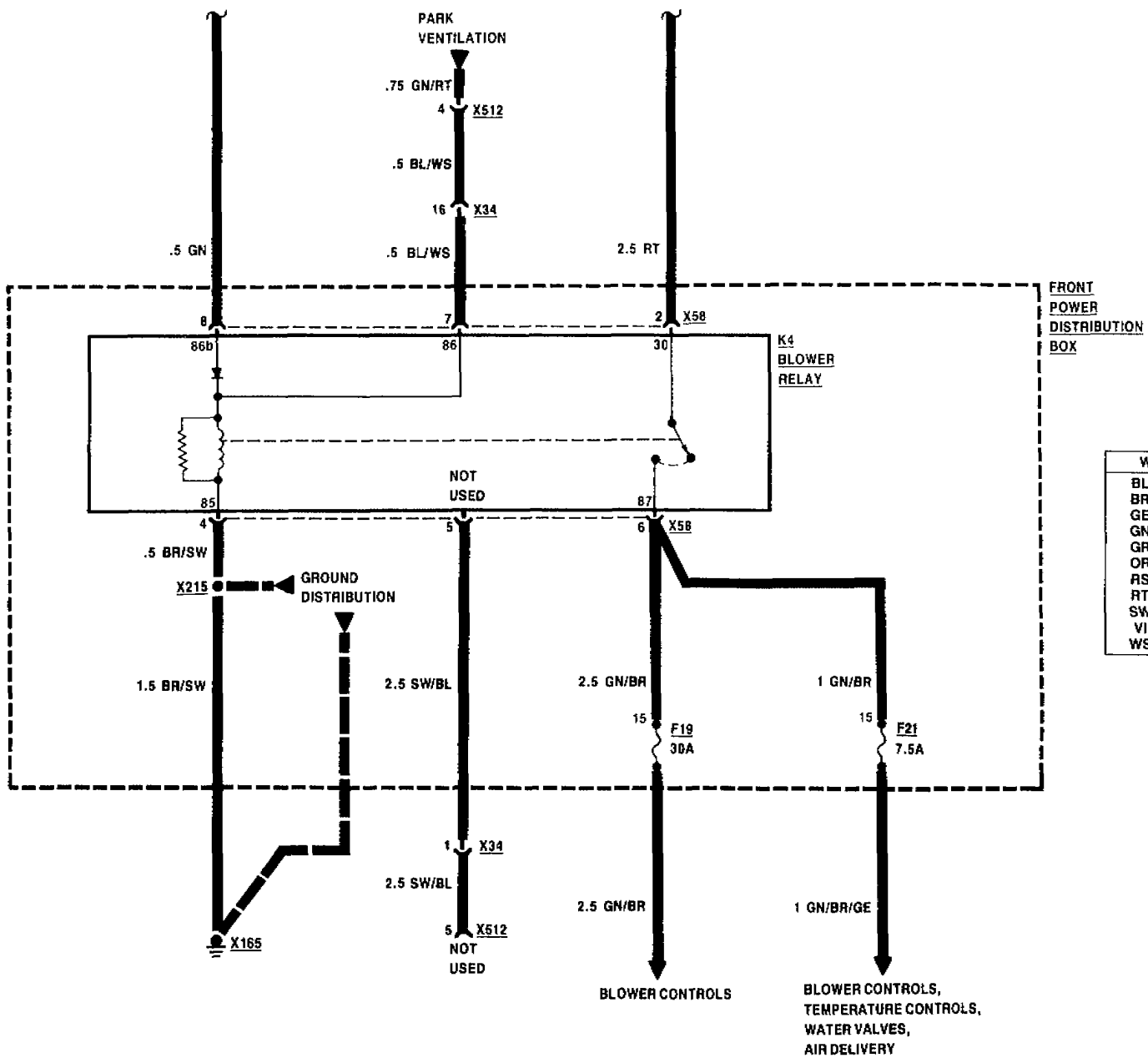

WIRE COLORS	
BL	BLUE
BR	BROWN
GE	YELLOW
GN	GREEN
GR	GRAY
OR	ORANGE
RS	PINK
RT	RED
SW	BLACK
VI	VIOLET
WS	WHITE



AUTOMATIC CLIMATE CONTROL (IHKA)

POWER

WIRE COLORS	
BL	BLUE
BR	BROWN
GE	YELLOW
GN	GREEN
GR	GRAY
OR	ORANGE
RS	PINK
RT	RED
SW	BLACK
VI	VIOLET
WS	WHITE

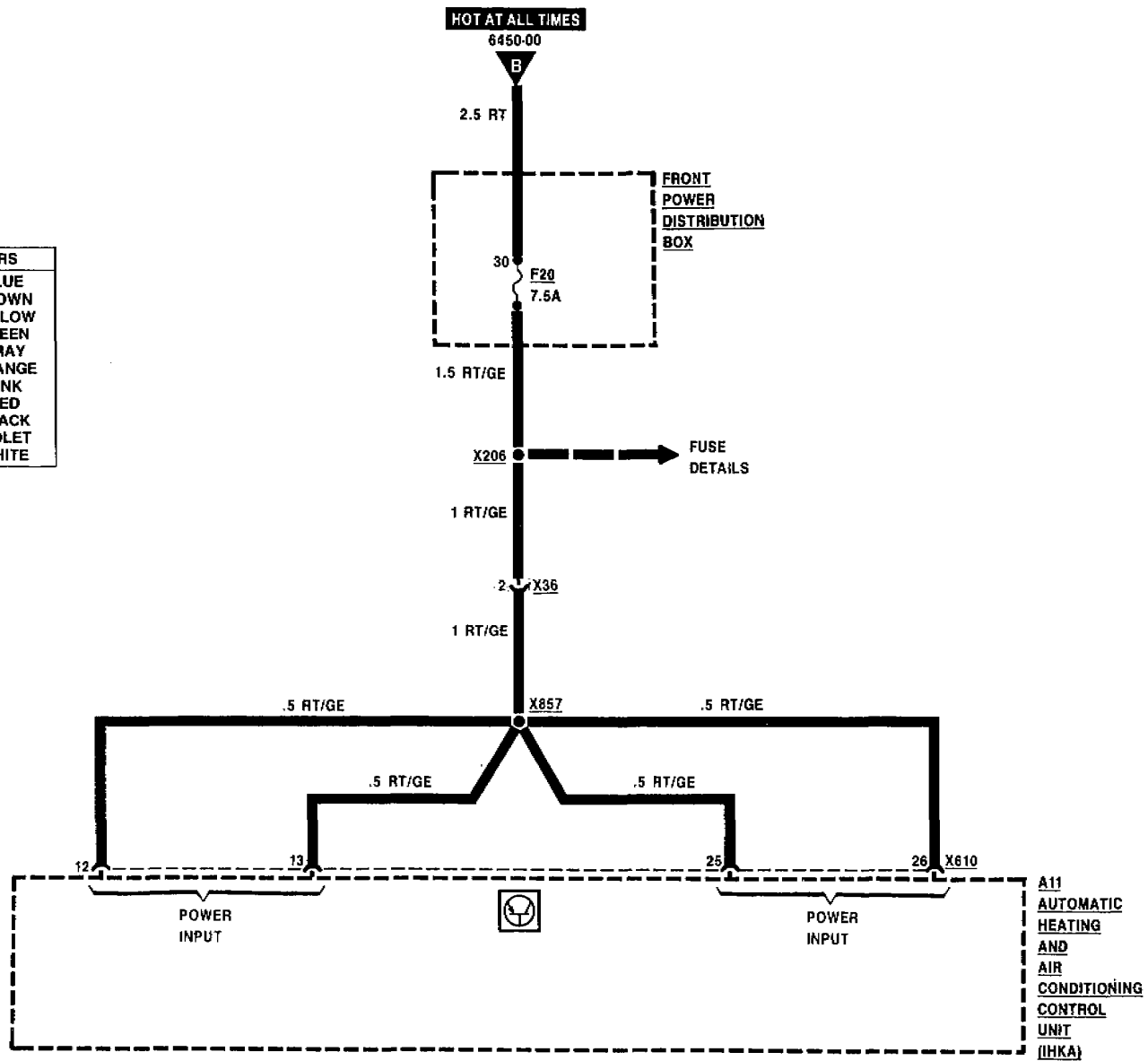



AUTOMATIC CLIMATE CONTROL (IHKA) GROUND

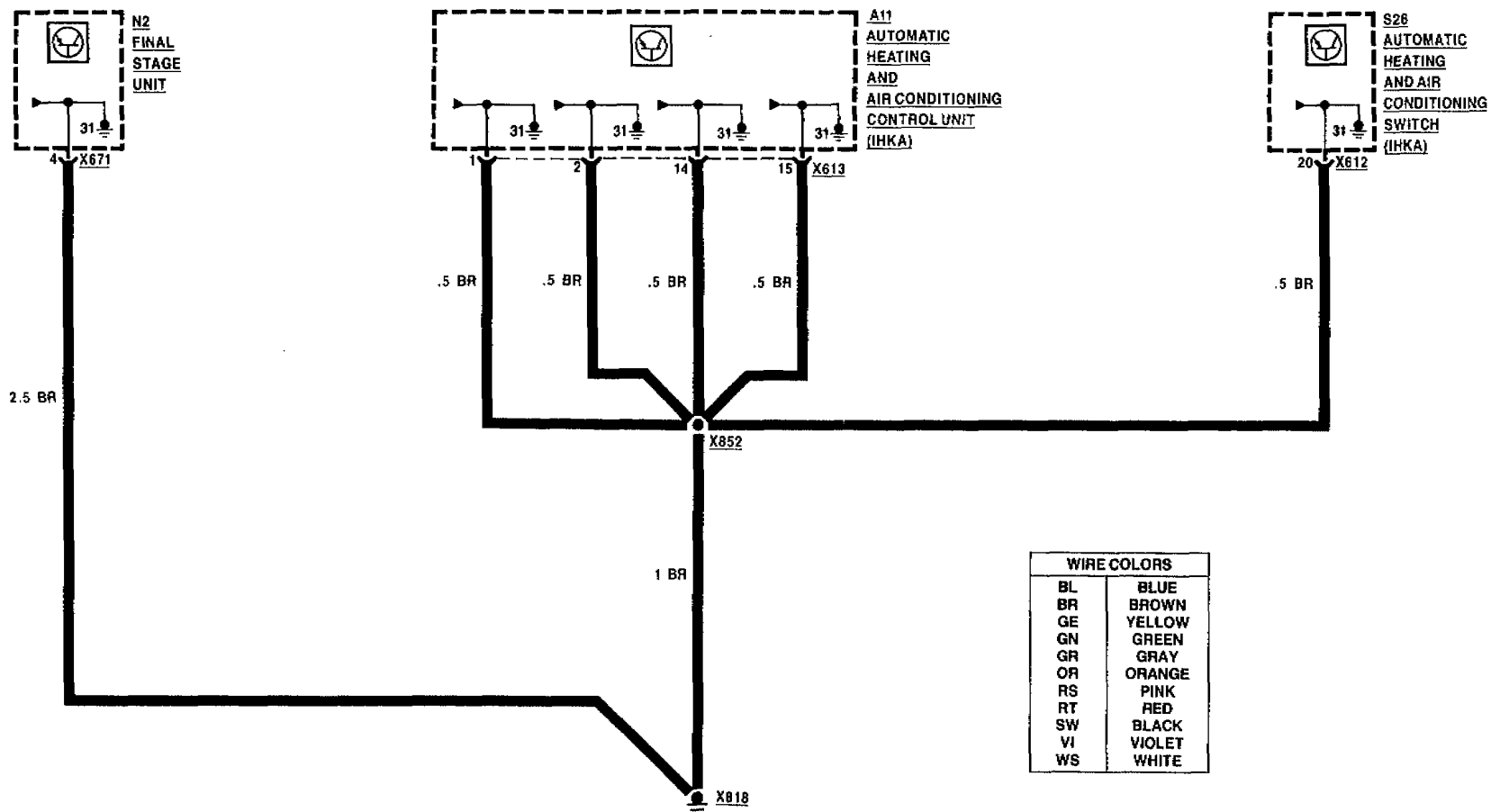



AUTOMATIC CLIMATE CONTROL (IHKA)

BLOWER CONTROL

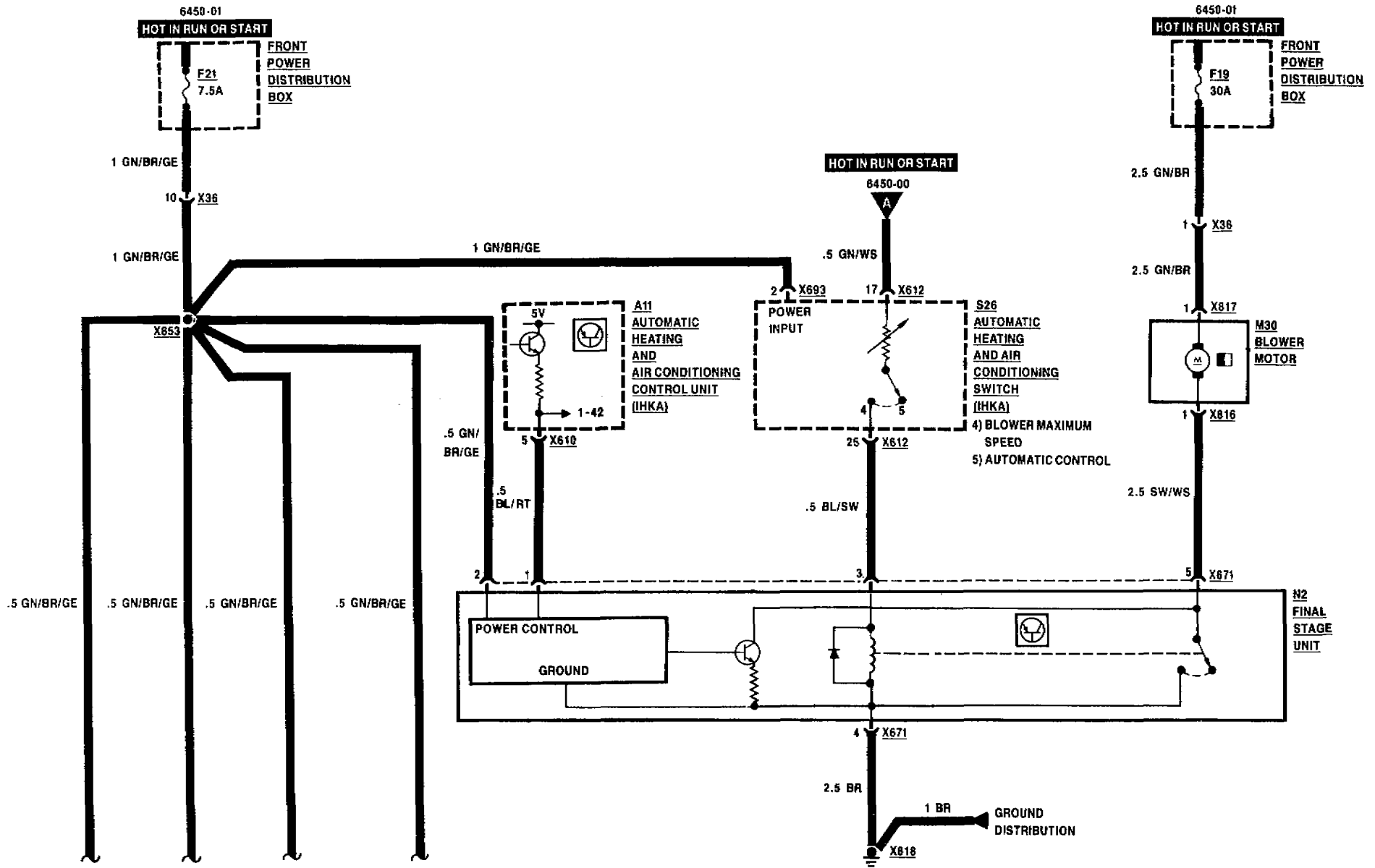

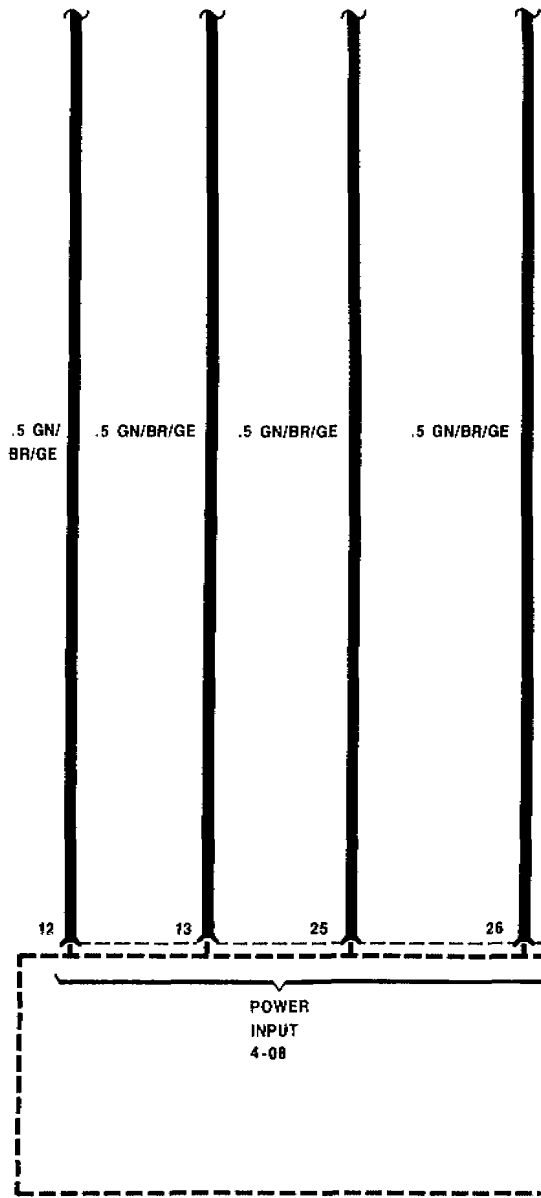

WIRE COLORS	
BL	BLUE
BR	BROWN
GE	YELLOW
GN	GREEN
GR	GRAY
OR	ORANGE
RS	PINK
RT	RED
SW	BLACK
VI	VIOLET
WS	WHITE

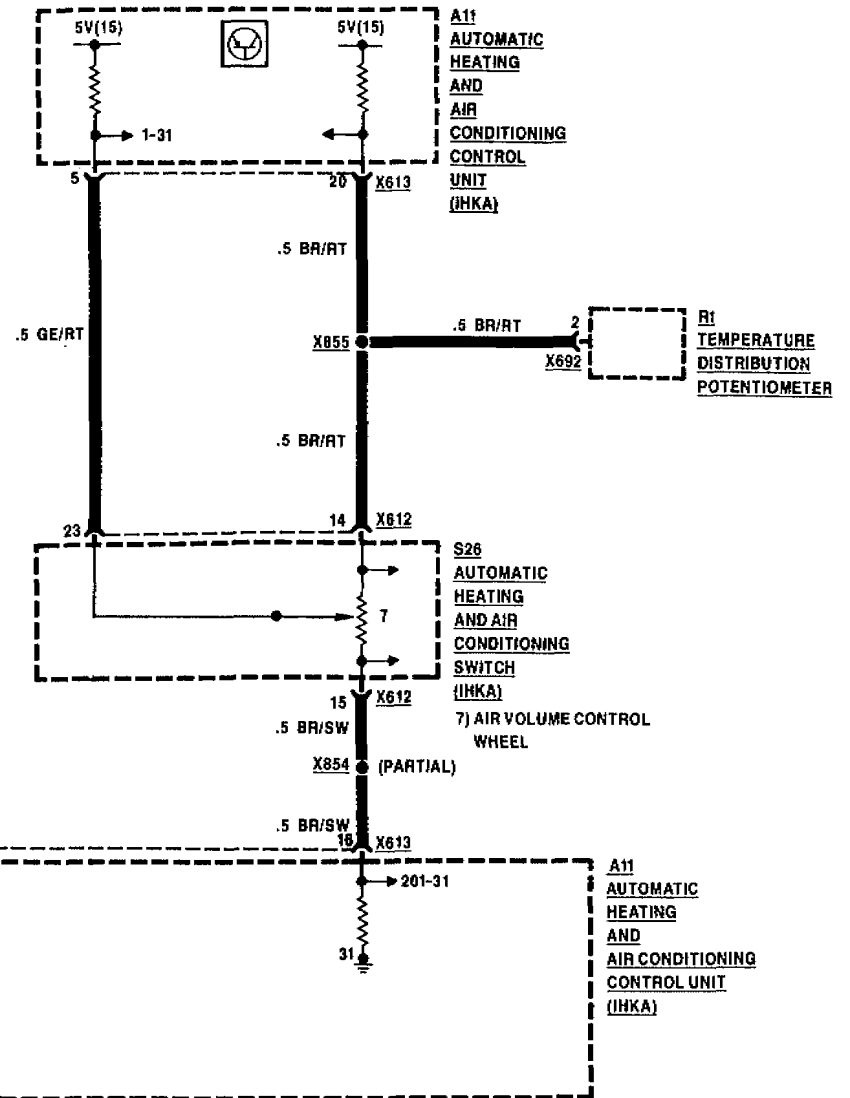



AUTOMATIC CLIMATE CONTROL (IHKA)

BLOWER CONTROLS

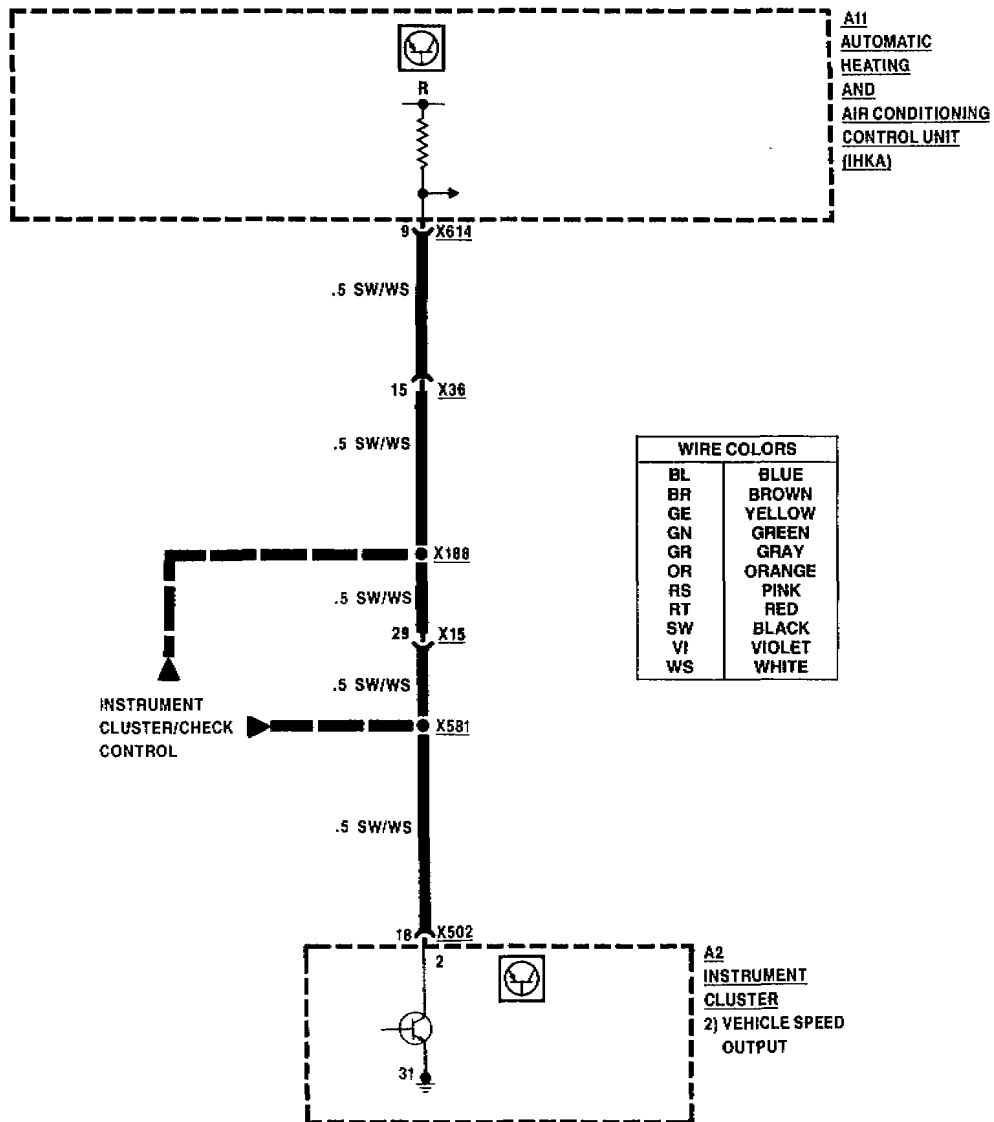



AUTOMATIC CLIMATE CONTROL (IHKA) TEMPERATURE CONTROLS

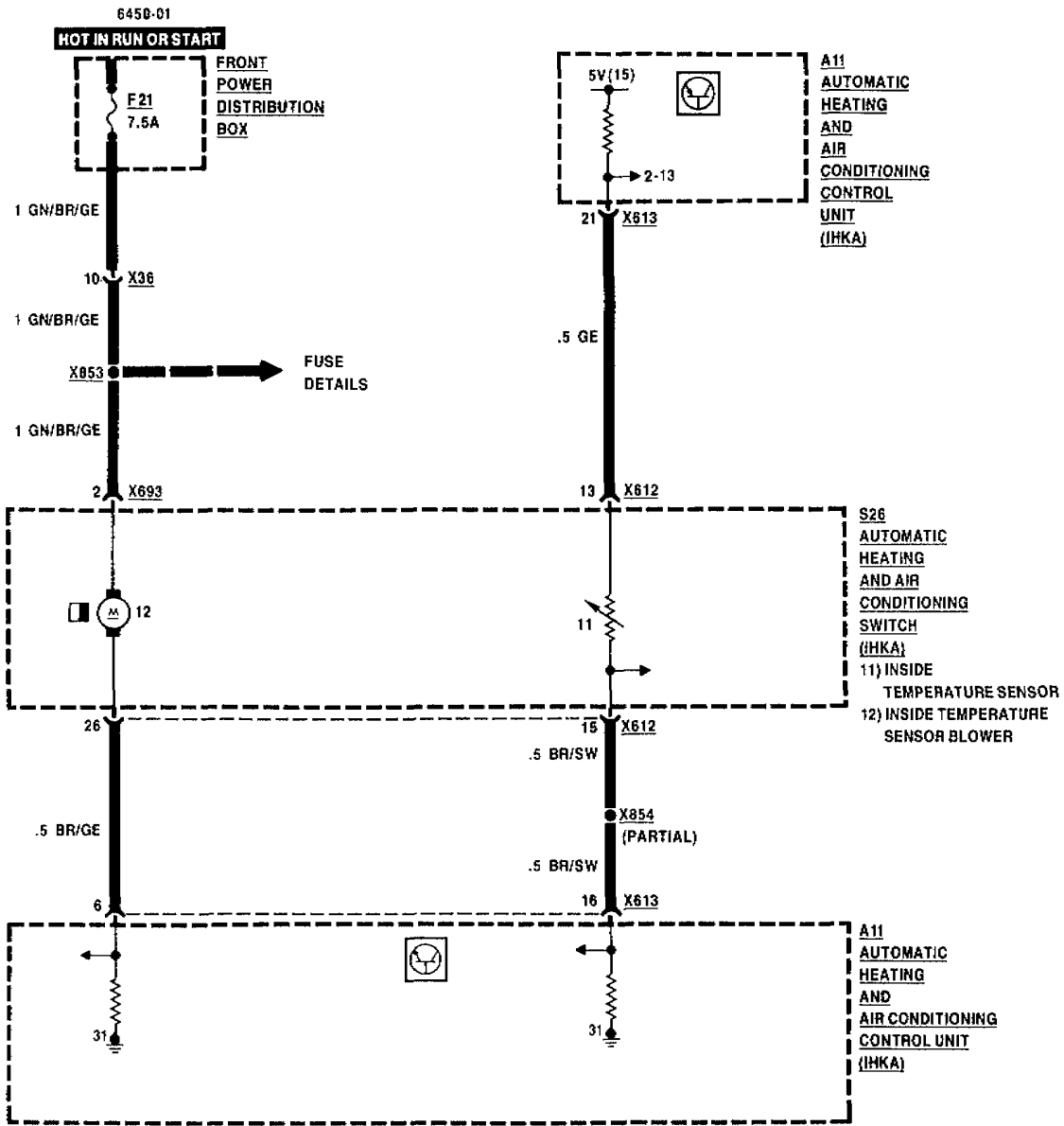

WIRE COLORS	
BL	BLUE
BR	BROWN
GE	YELLOW
GN	GREEN
GR	GRAY
OR	ORANGE
RS	PINK
RT	RED
SW	BLACK
VI	VIOLET
WS	WHITE



AUTOMATIC CLIMATE CONTROL (IHKA) TEMPERATURE CONTROLS

WIRE COLORS	
BL	BLUE
BR	BROWN
GE	YELLOW
GN	GREEN
GR	GRAY
OR	ORANGE
RS	PINK
RT	RED
SW	BLACK
VI	VIOLET
WS	WHITE

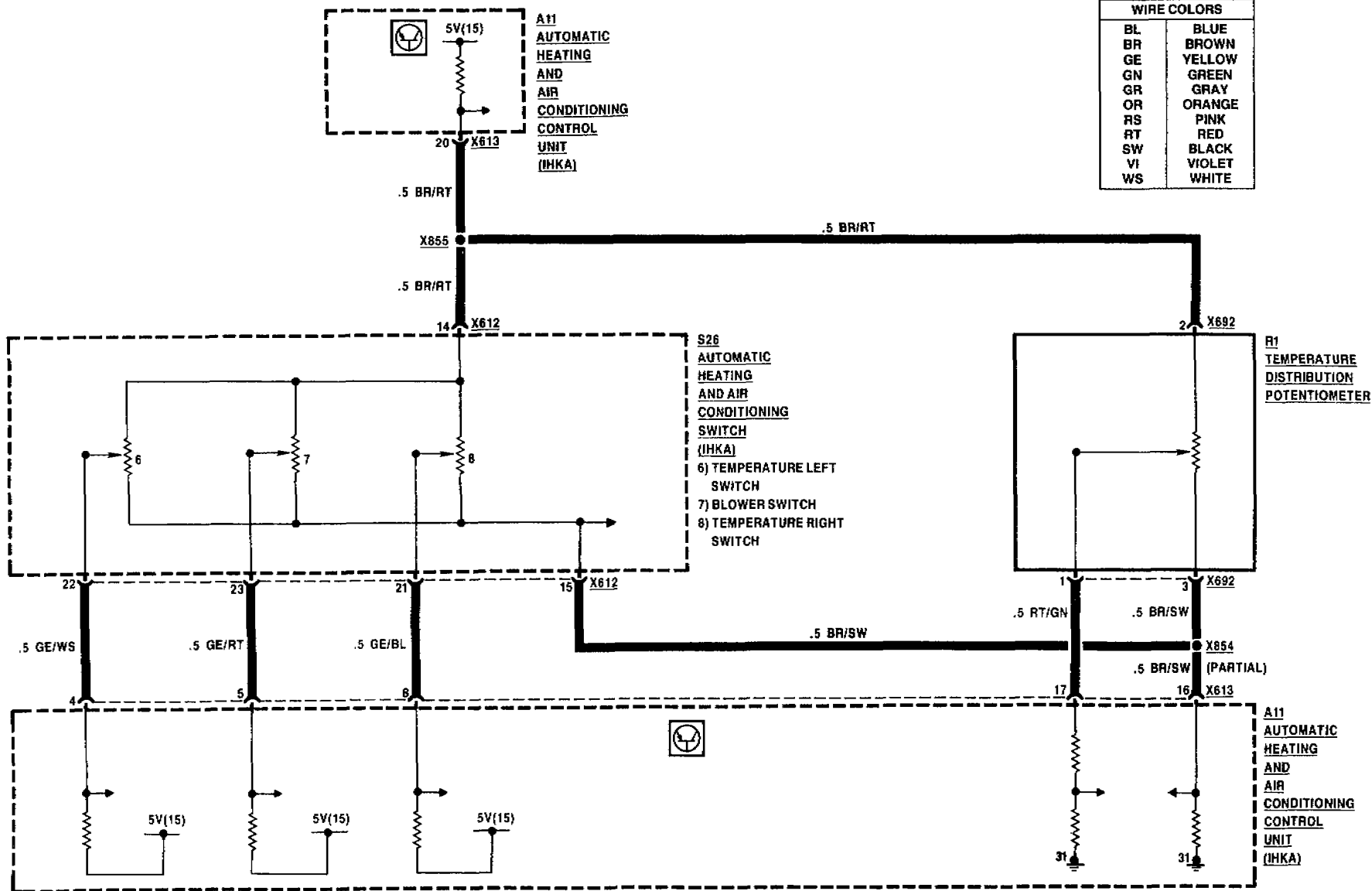



AUTOMATIC CLIMATE CONTROL (IHKA)

TEMPERATURE CONTROLS

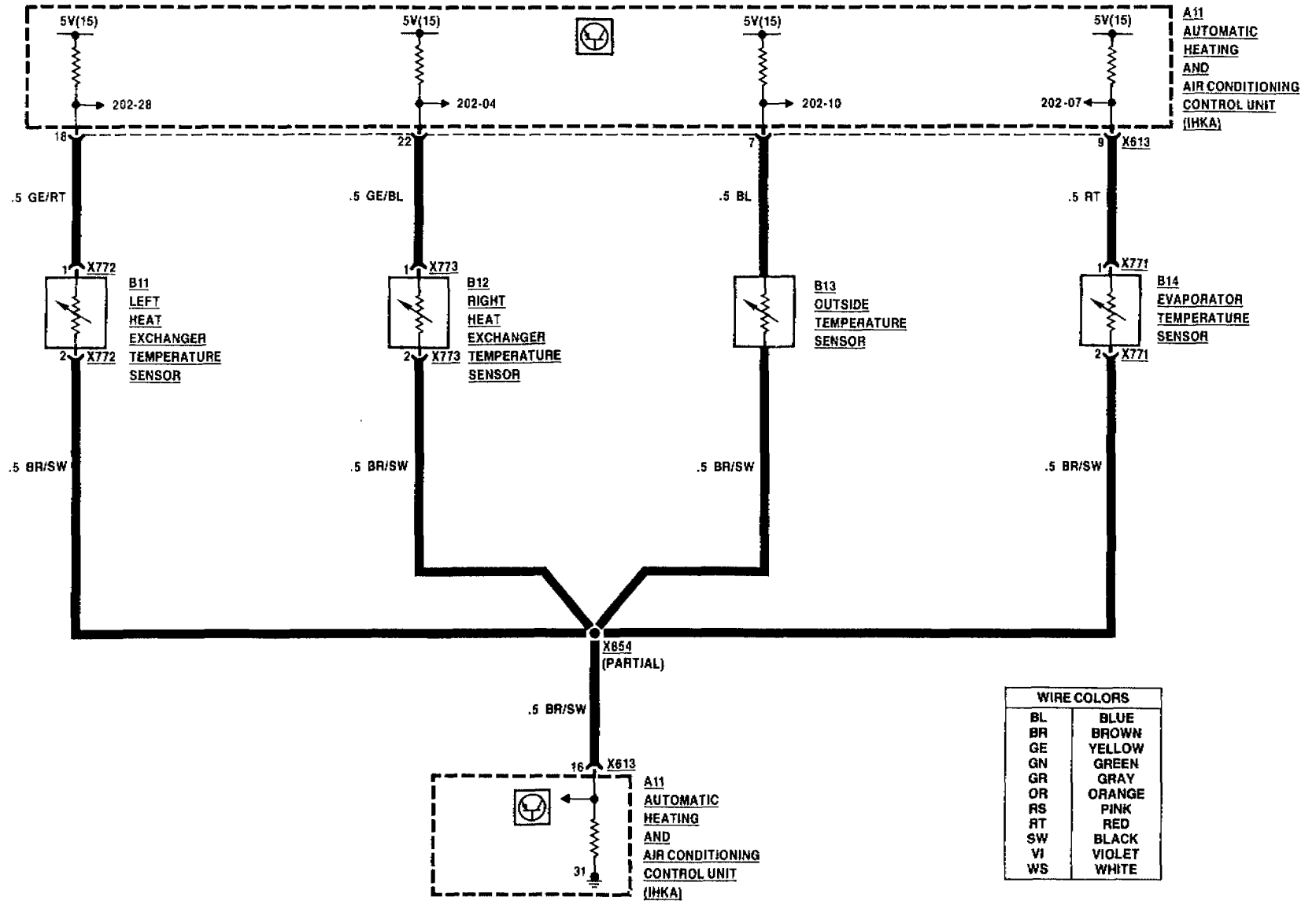



AUTOMATIC CLIMATE CONTROL (IHKA) AIR DELIVERY

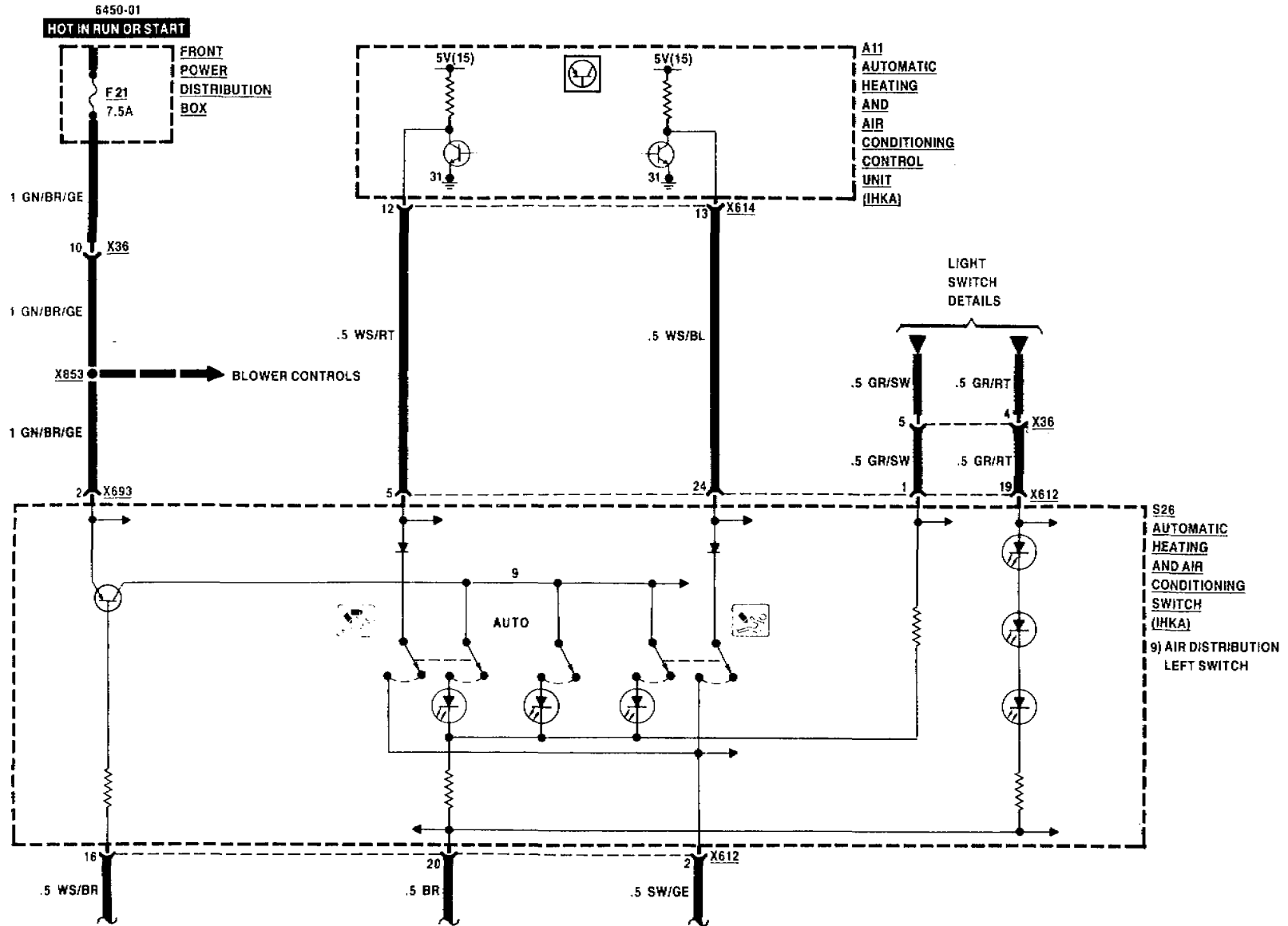

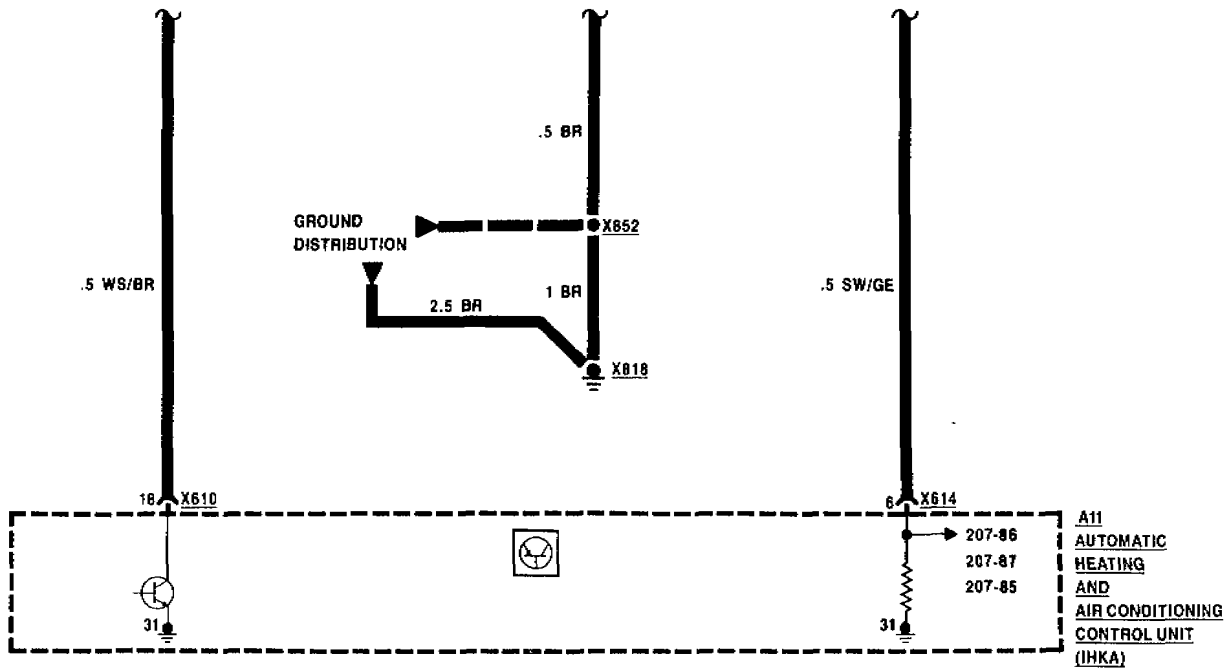

WIRE COLORS	
BL	BLUE
BR	BROWN
GE	YELLOW
GN	GREEN
GR	GRAY
OR	ORANGE
RS	PINK
RT	RED
SW	BLACK
VI	VIOLET
WS	WHITE



AUTOMATIC CLIMATE CONTROL (IHKA)

AIR DELIVERY

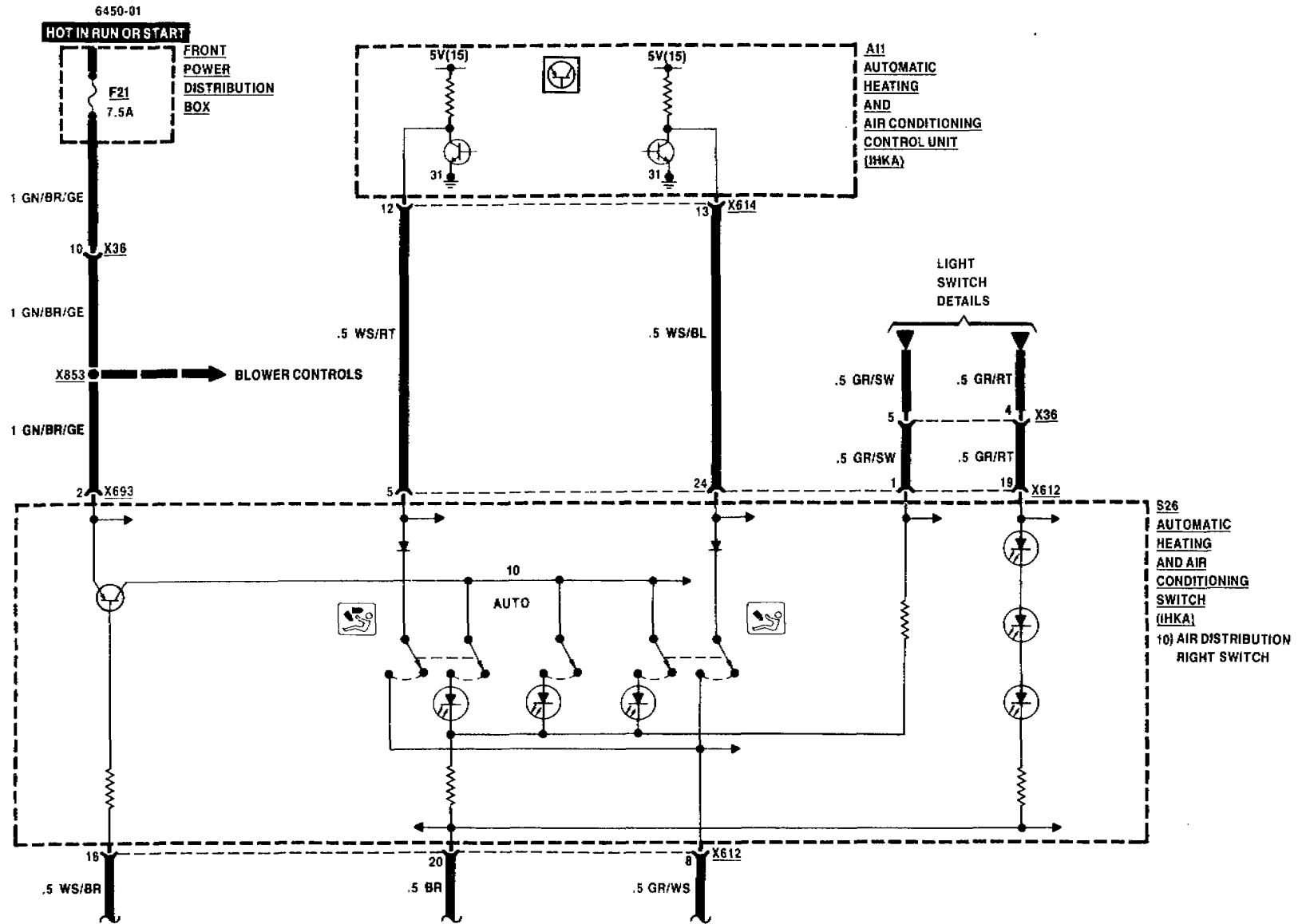

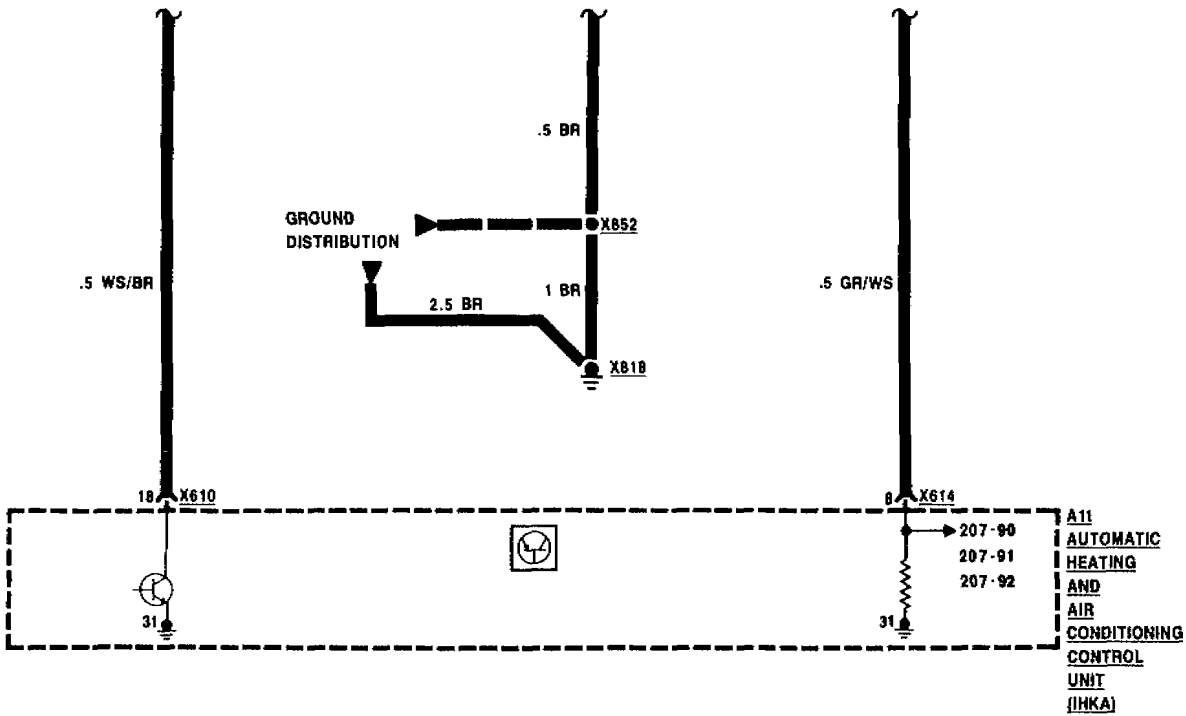

WIRE COLORS	
BL	BLUE
BR	BROWN
GE	YELLOW
GN	GREEN
GR	GRAY
OR	ORANGE
RS	PINK
RT	RED
SW	BLACK
VI	VIOLET
WS	WHITE



AUTOMATIC CLIMATE CONTROL (IHKA)

AIR DELIVERY

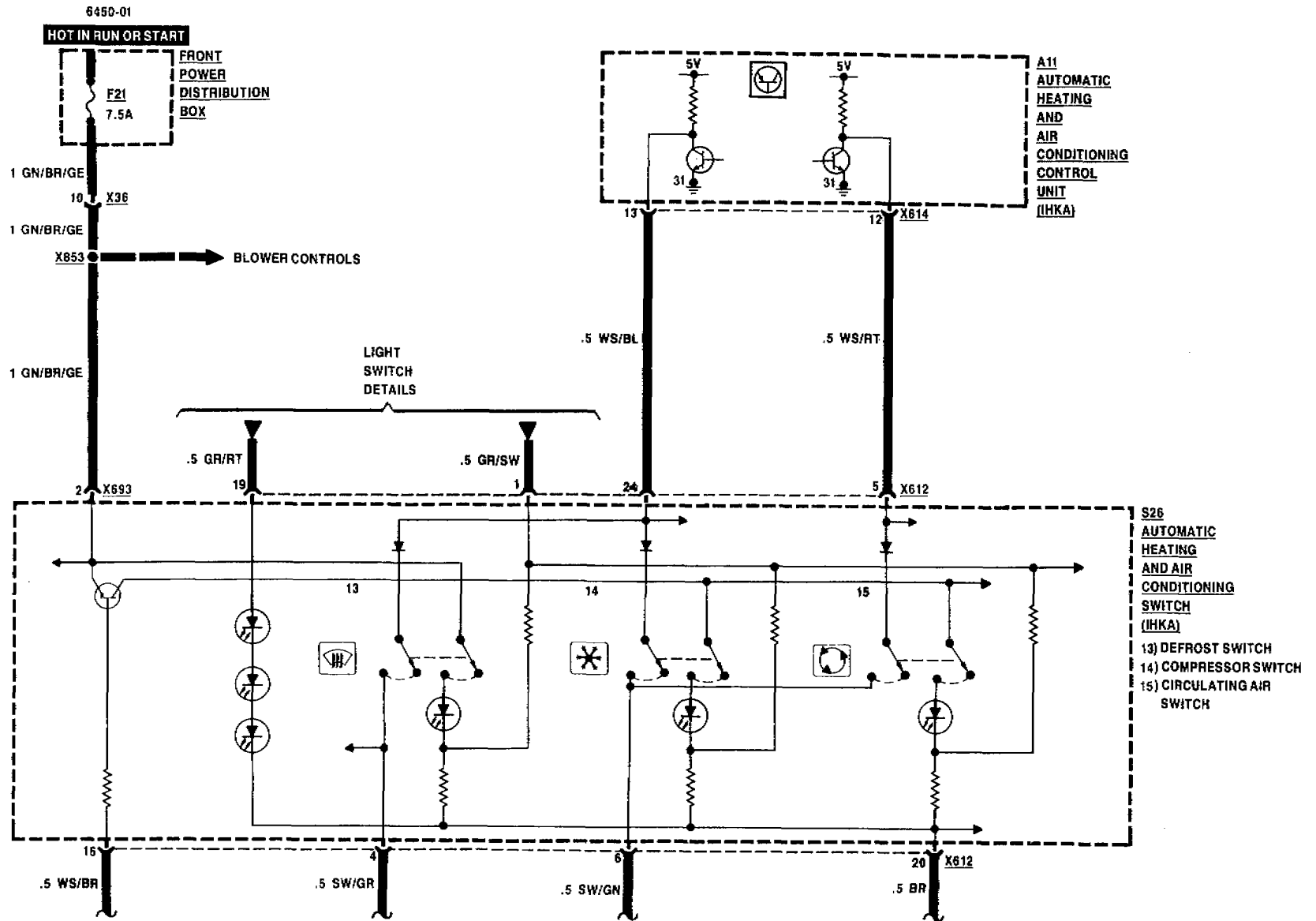

WIRE COLORS	
BL	BLUE
BR	BROWN
GE	YELLOW
GN	GREEN
GR	GRAY
OR	ORANGE
RS	PINK
RT	RED
SW	BLACK
VI	VIOLET
WS	WHITE

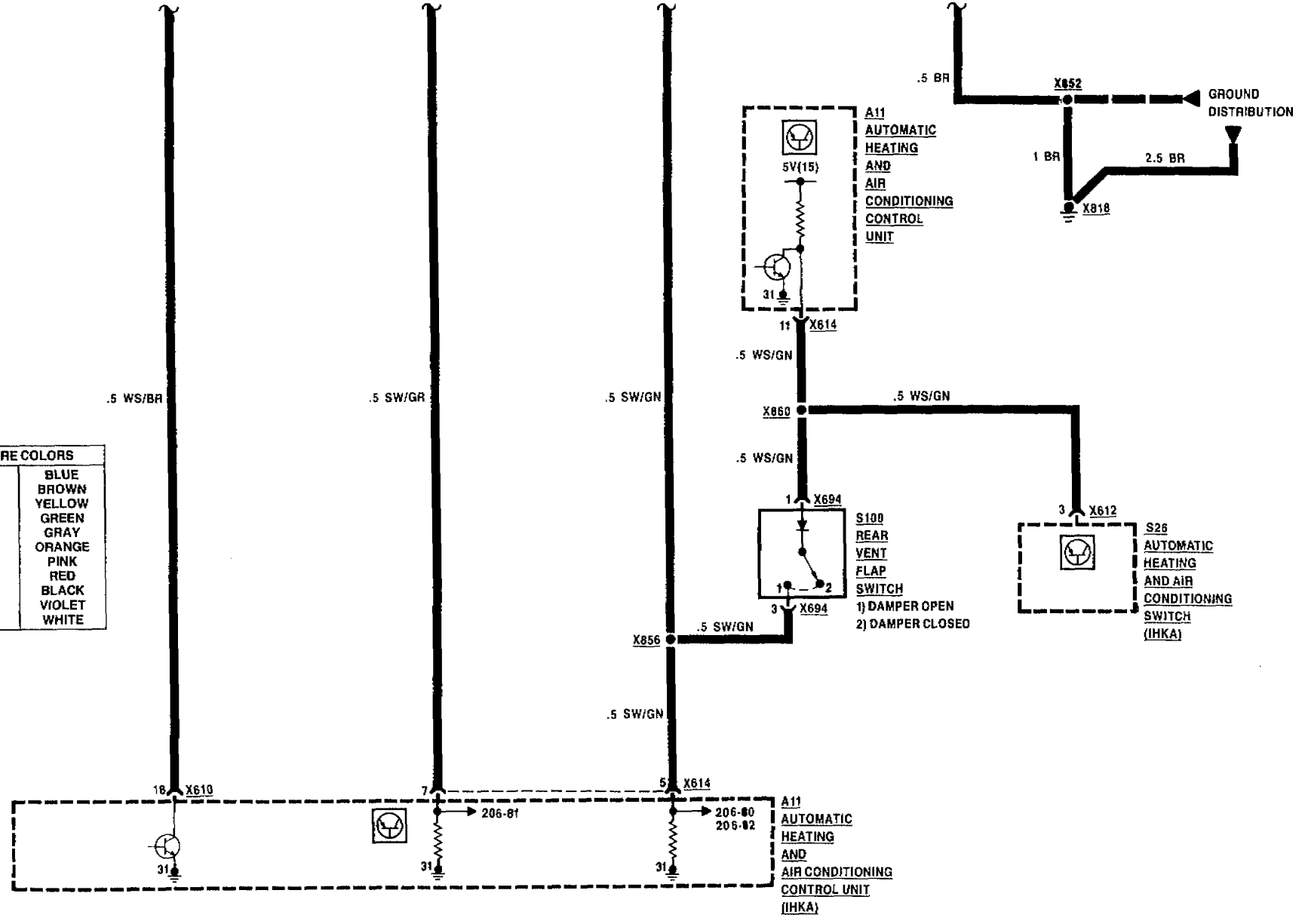



AUTOMATIC CLIMATE CONTROL (IHKA)

AIR DELIVERY

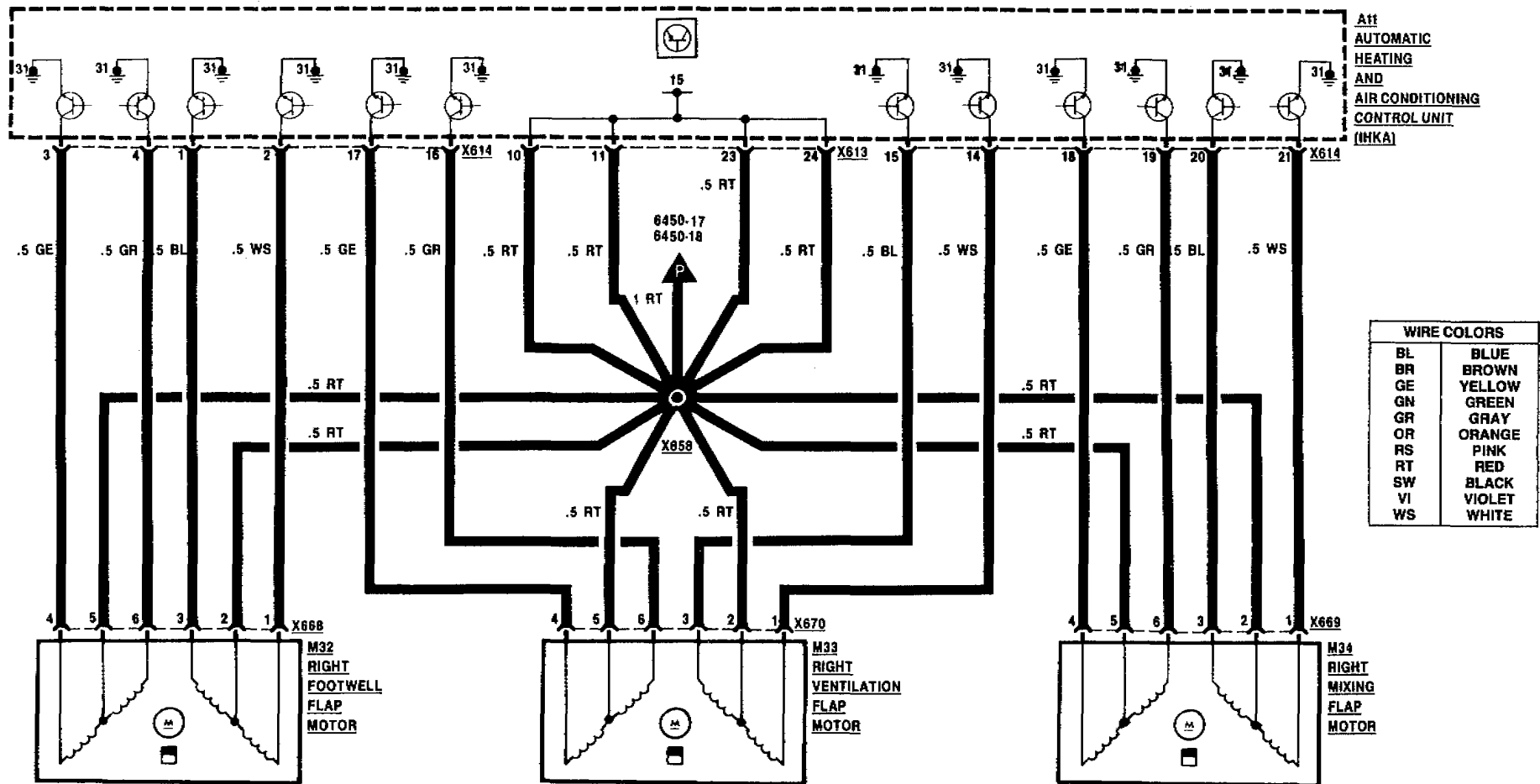



AUTOMATIC CLIMATE CONTROL (IHKA) AIR DELIVERY

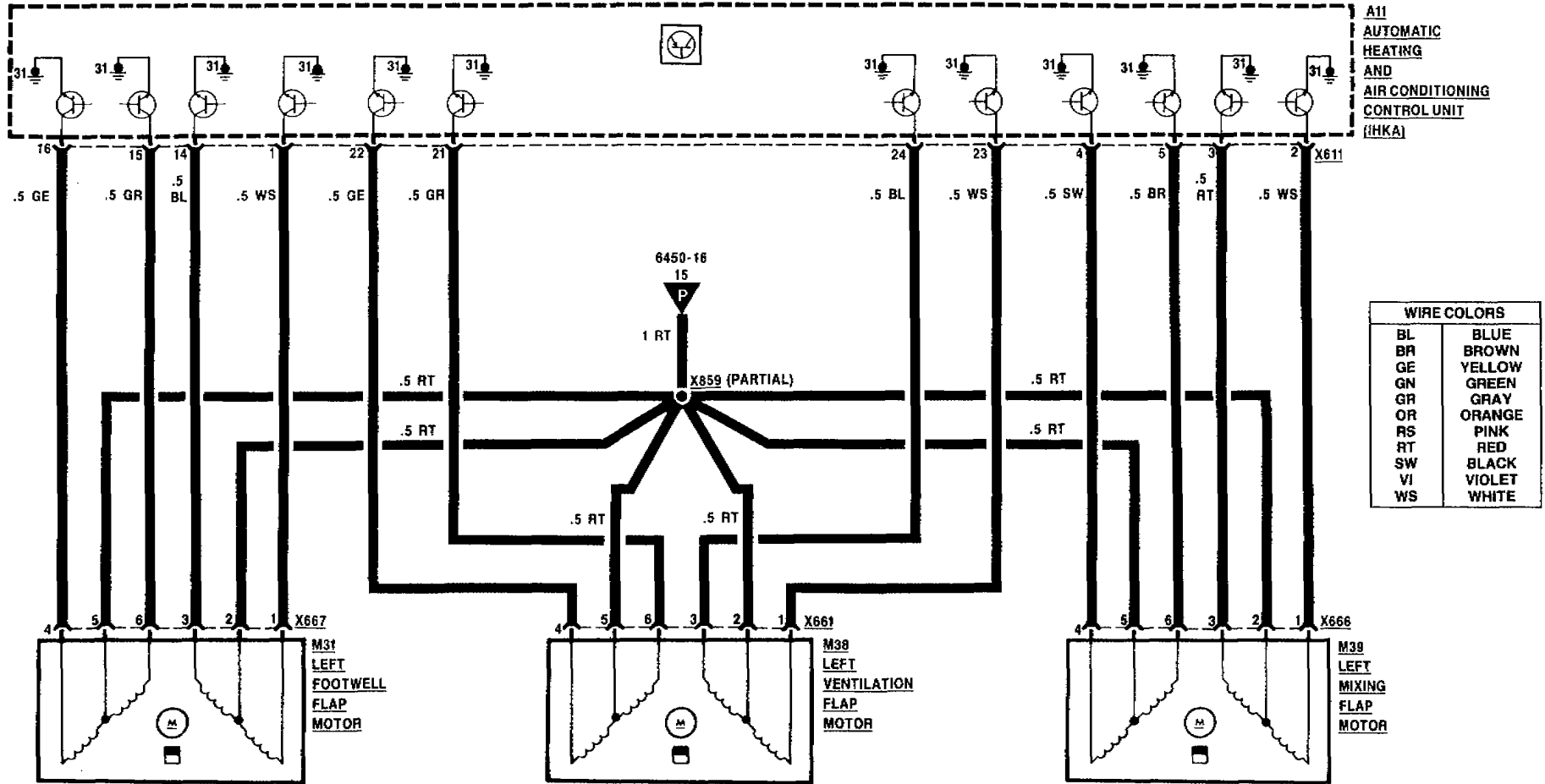



AUTOMATIC CLIMATE CONTROL (IHKA)

AIR DELIVERY

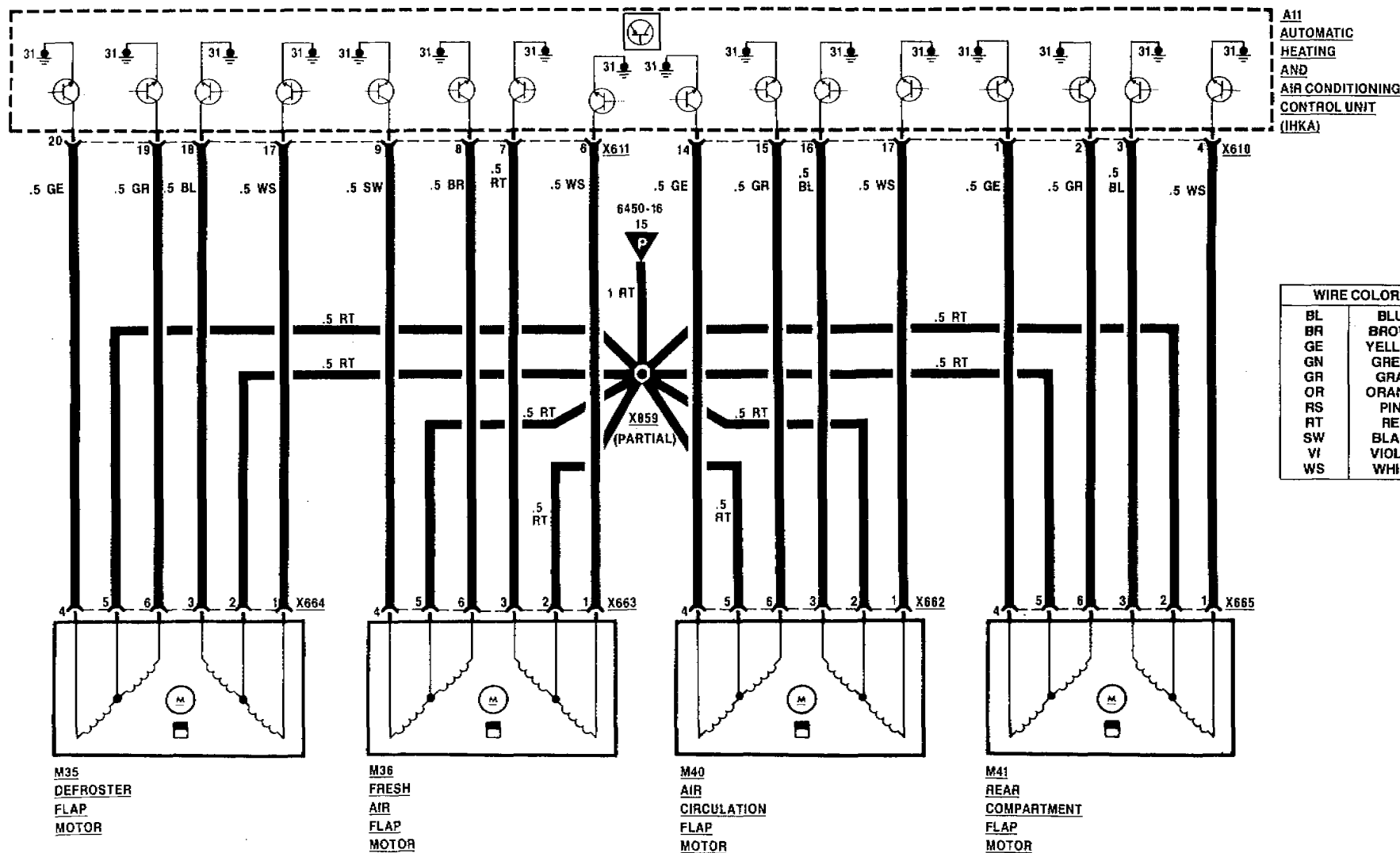

**FOR AUTOMATIC CLIMATE CONTROL (IHKA):
COMPRESSOR CONTROLS,
SEE PAGE 6450-20**



AUTOMATIC CLIMATE CONTROL (IHKA) COMPRESSOR CONTROLS

735i, 735iL

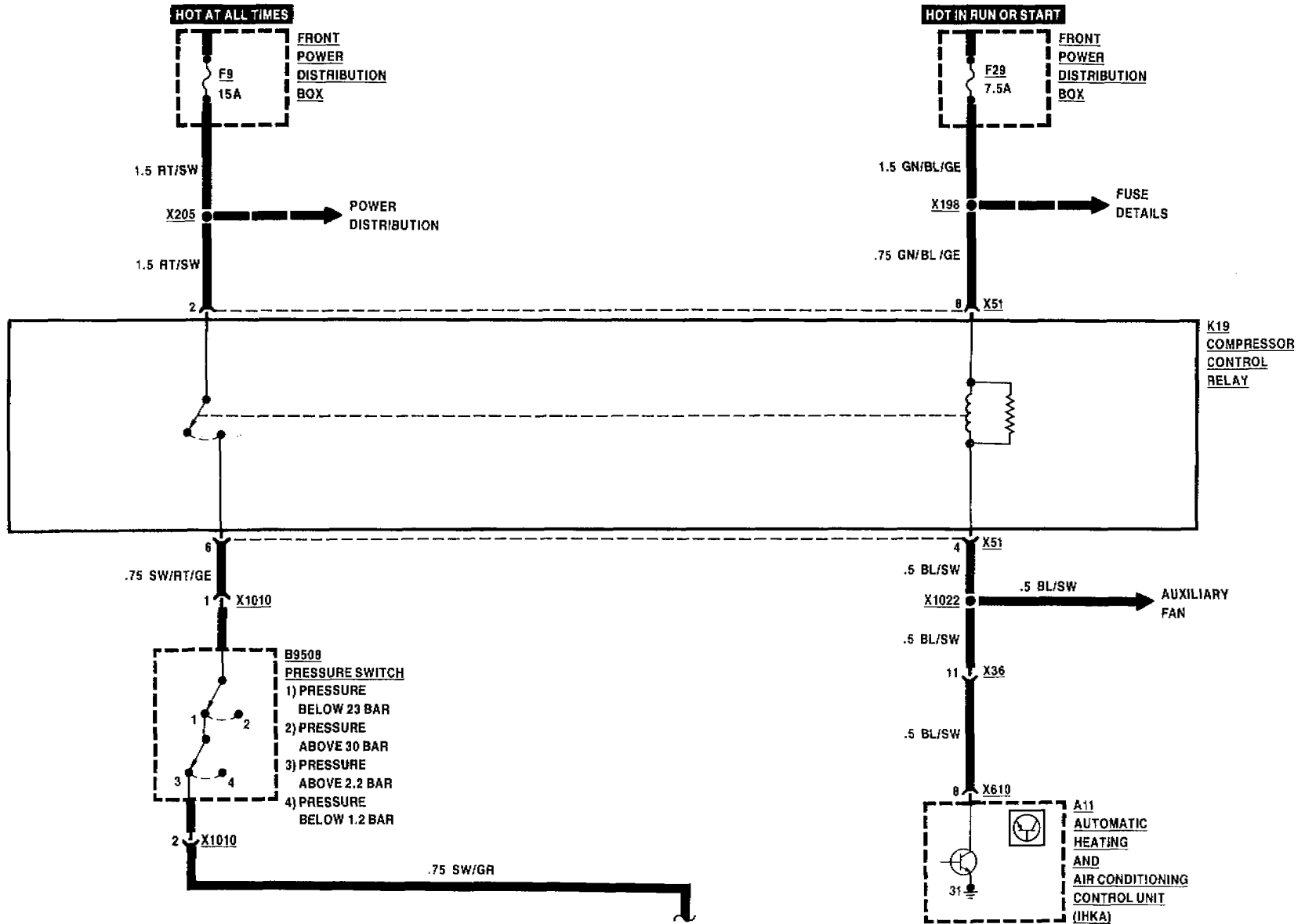

WIRE COLORS	
BL	BLUE
BR	BROWN
GE	YELLOW
GN	GREEN
GR	GRAY
OR	ORANGE
RS	PINK
RT	RED
SW	BLACK
VI	VIOLET
WS	WHITE

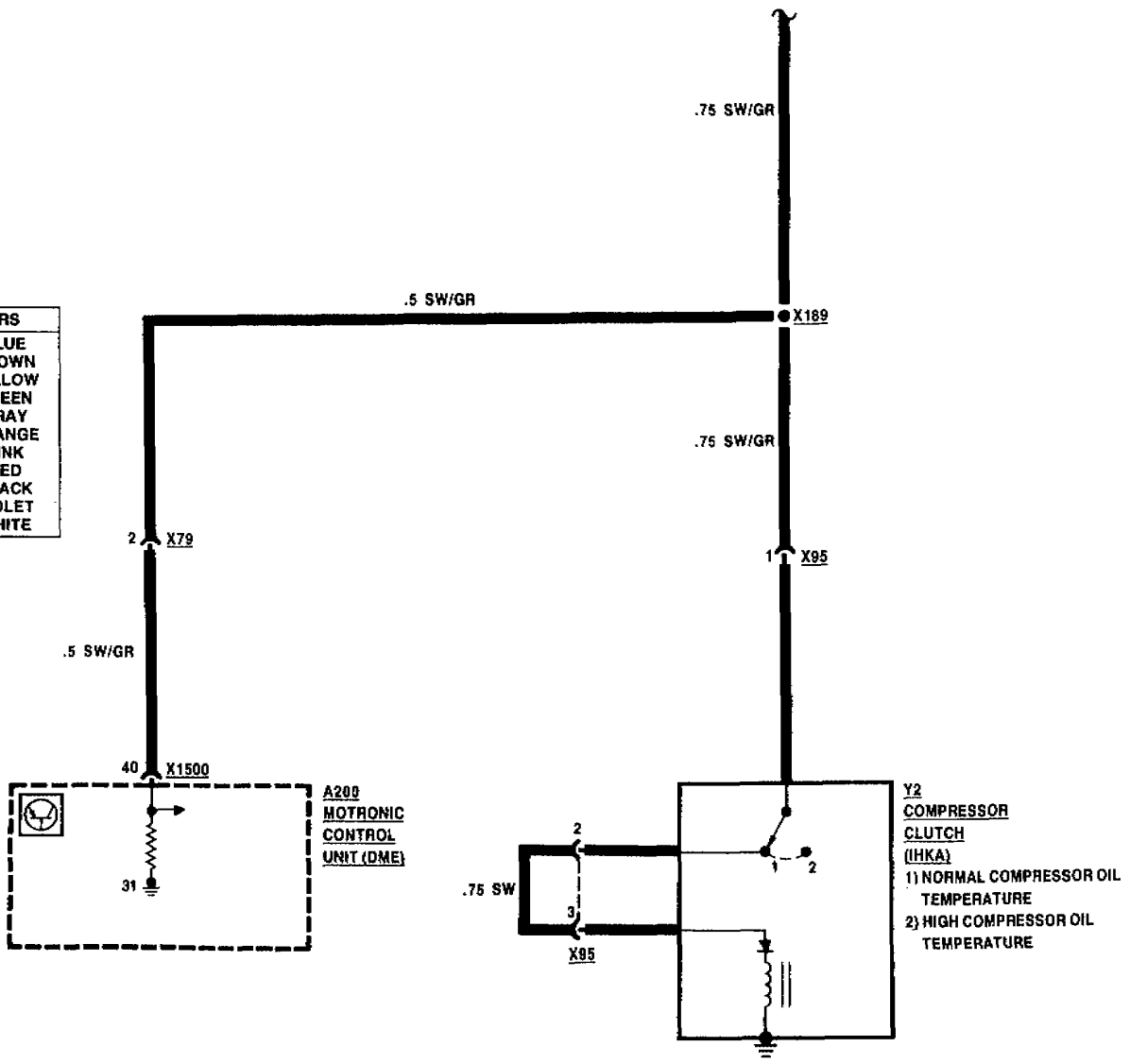



AUTOMATIC CLIMATE CONTROL (IHKA) COMPRESSOR CONTROL

750iL

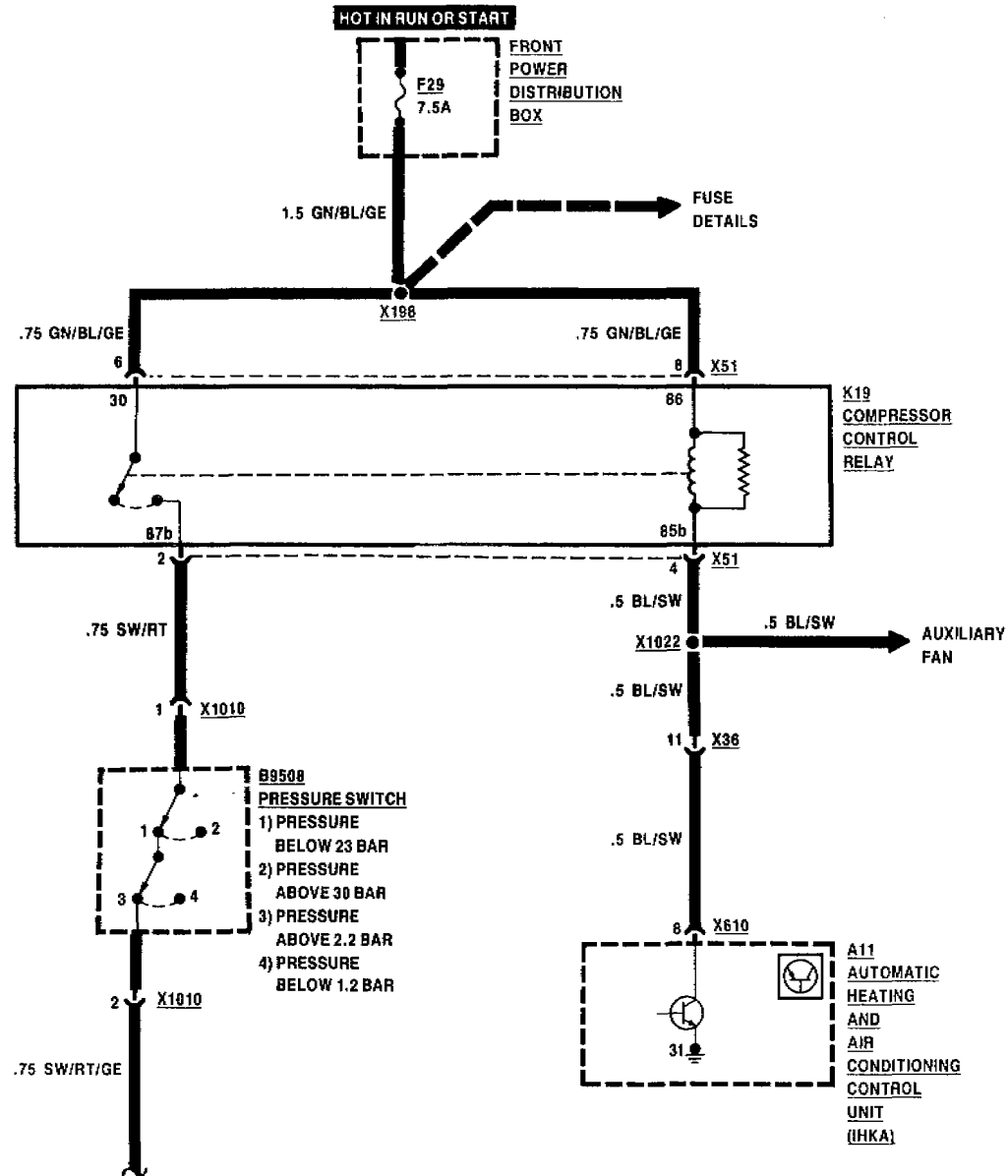

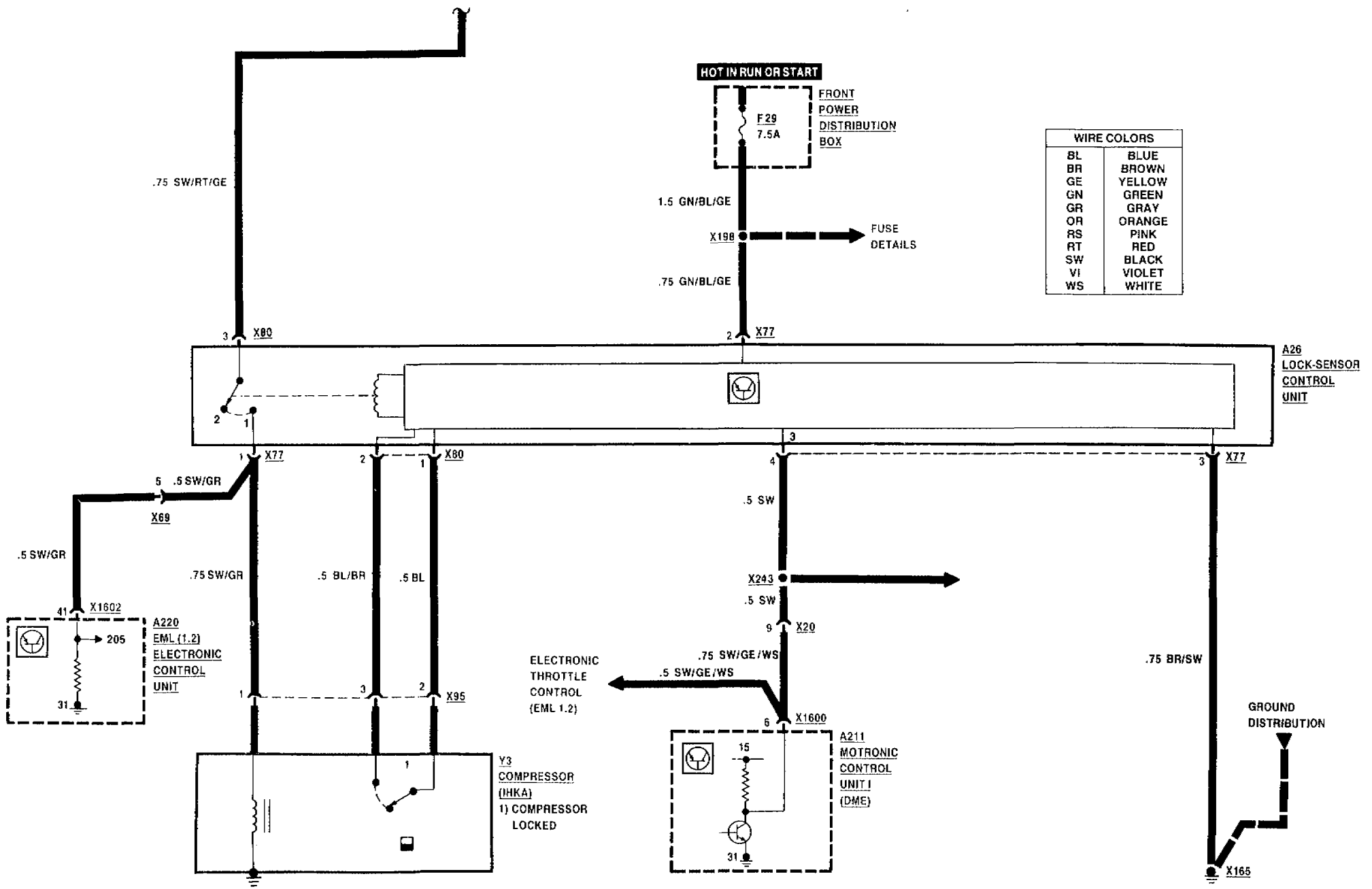



AUTOMATIC CLIMATE CONTROL (IHKA) FRONT WINDOW DEFOGGER

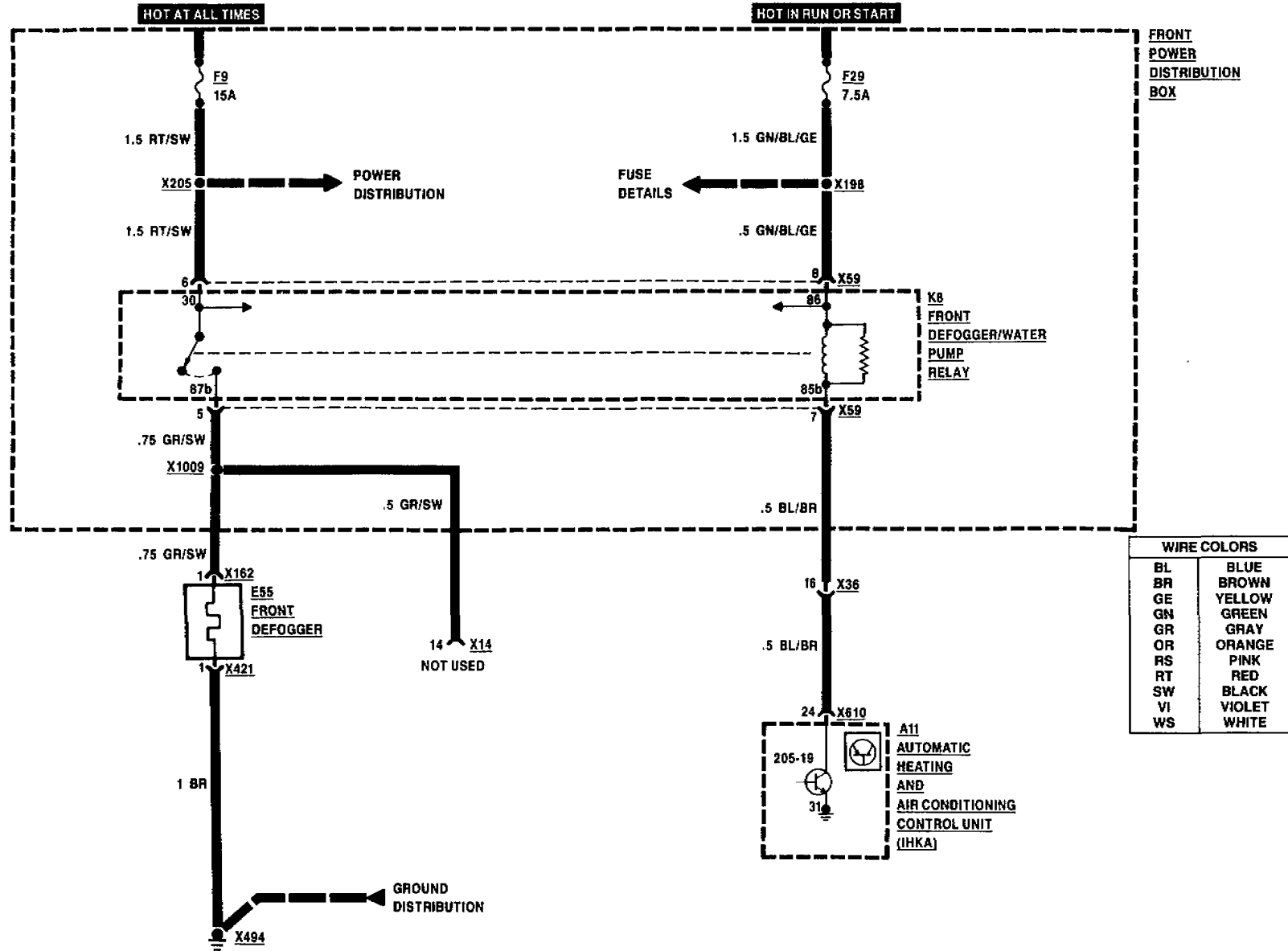



AUTOMATIC CLIMATE CONTROL (IHKA) AUXILIARY WATER PUMP

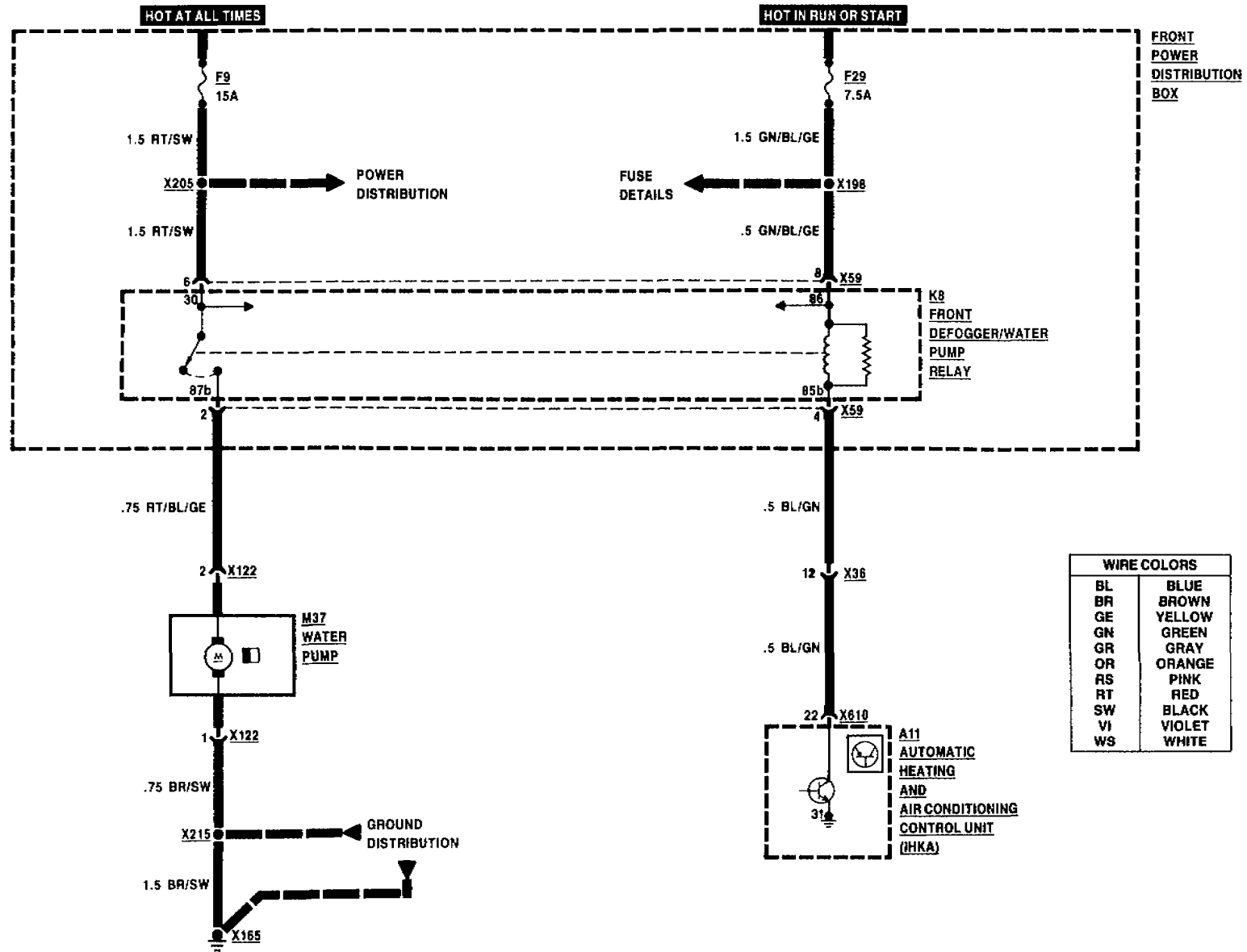



AUTOMATIC CLIMATE CONTROL (IHKA) WATER VALVES

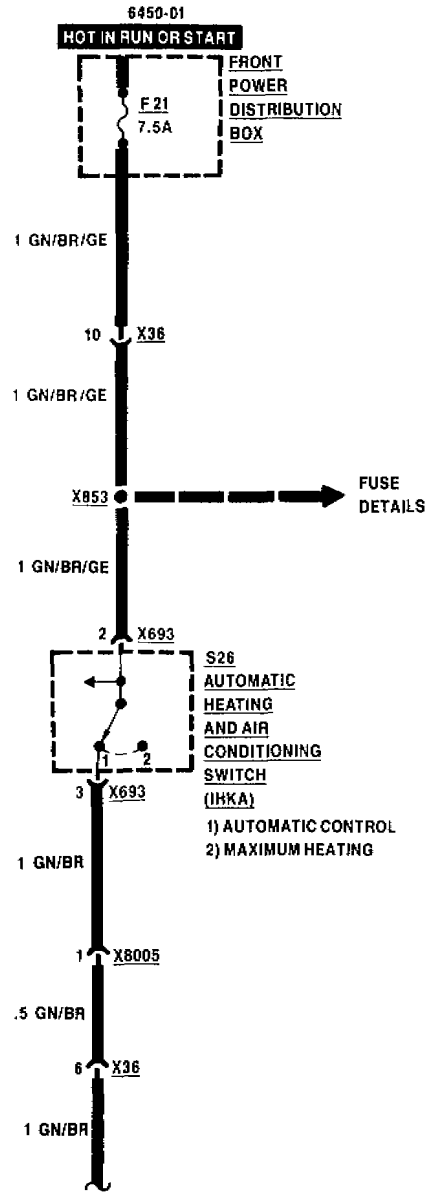

WIRE COLORS	
BL	BLUE
BR	BROWN
GE	YELLOW
GN	GREEN
GR	GRAY
OR	ORANGE
RS	PINK
RT	RED
SW	BLACK
VI	VIOLET
WS	WHITE

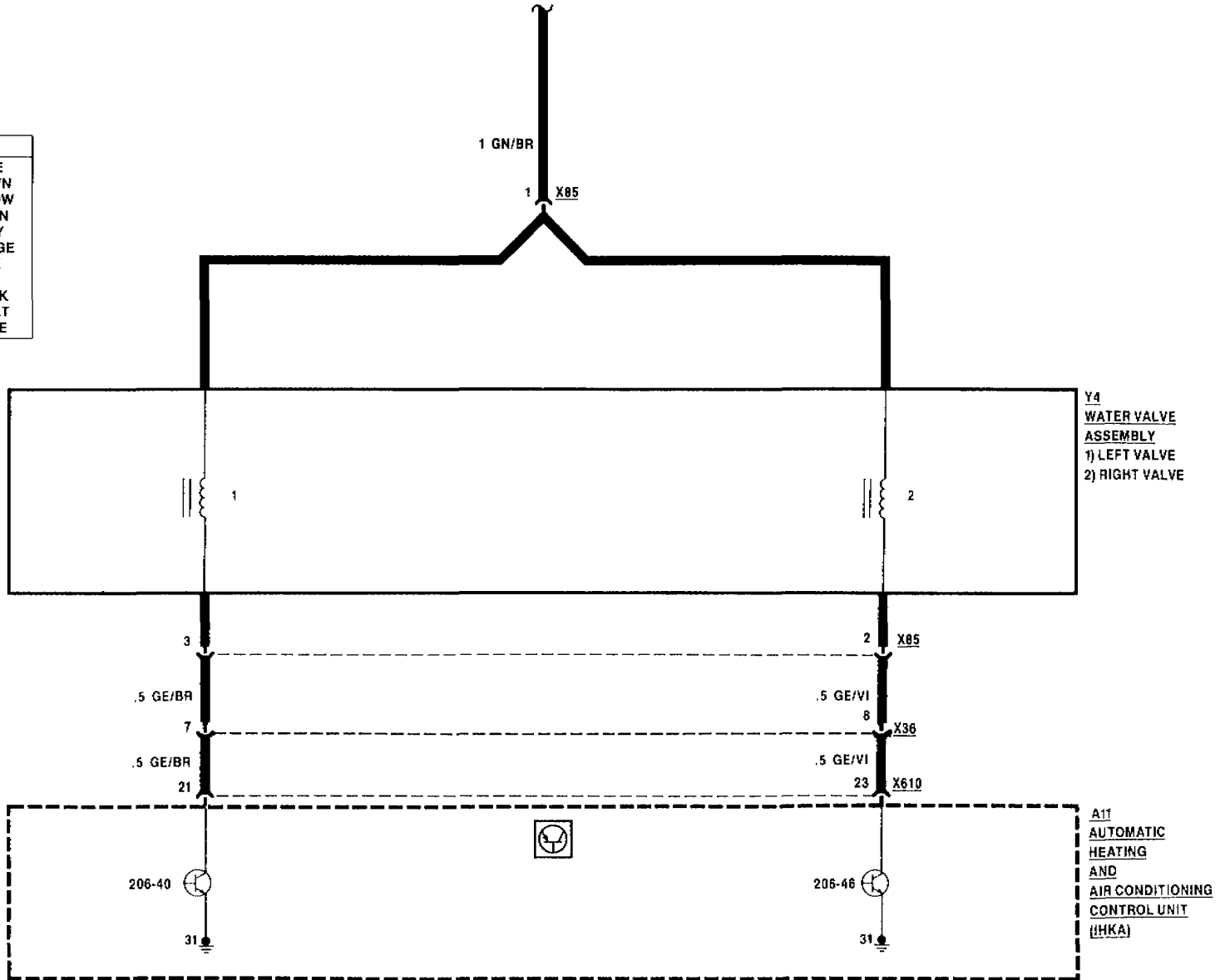



AUTOMATIC CLIMATE CONTROL (IHKA)

DIAGNOSTIC LINK AND STARTER INPUT

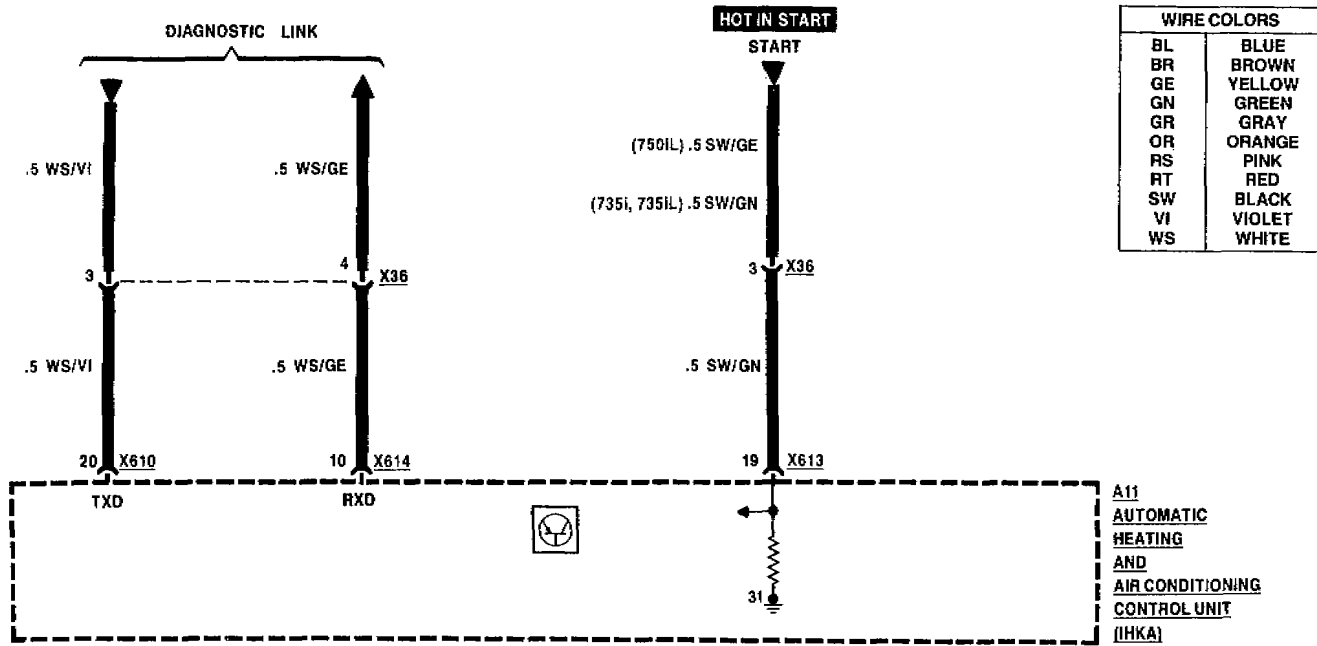



AUXILIARY FAN

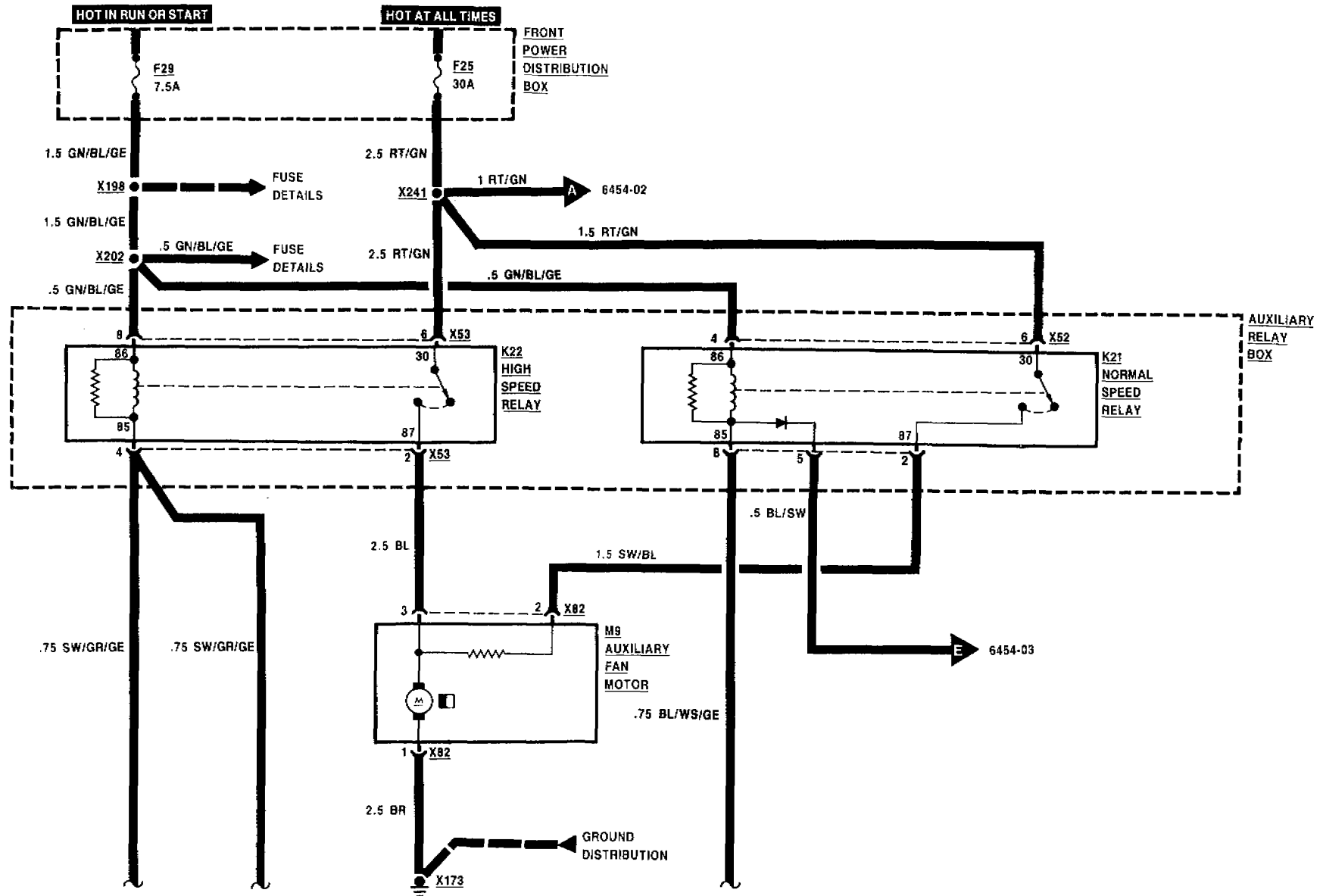

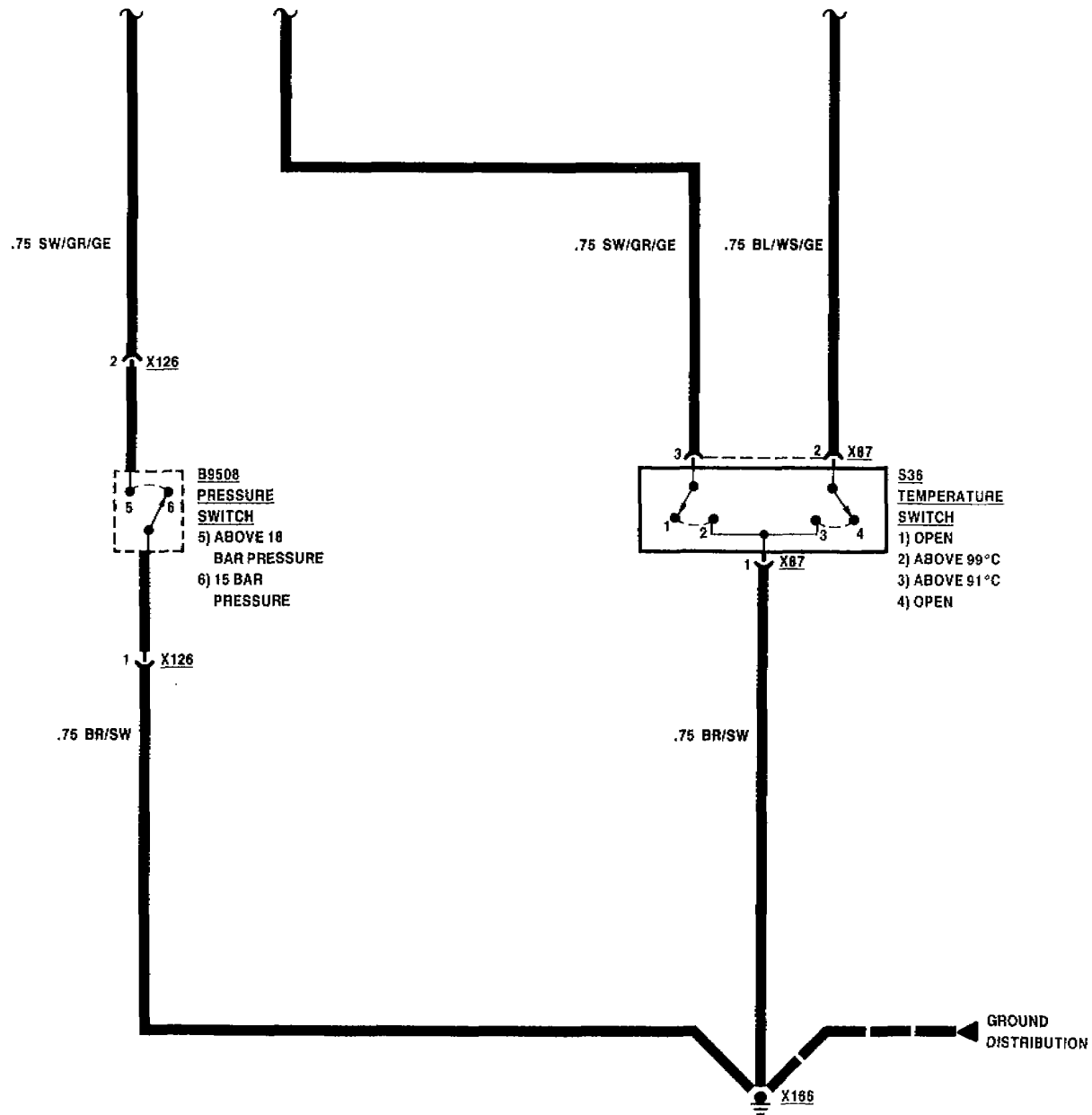

WIRE COLORS	
BL	BLUE
BR	BROWN
GE	YELLOW
GN	GREEN
GR	GRAY
OR	ORANGE
RS	PINK
RT	RED
SW	BLACK
VI	VIOLET
WS	WHITE

AUXILIARY FAN

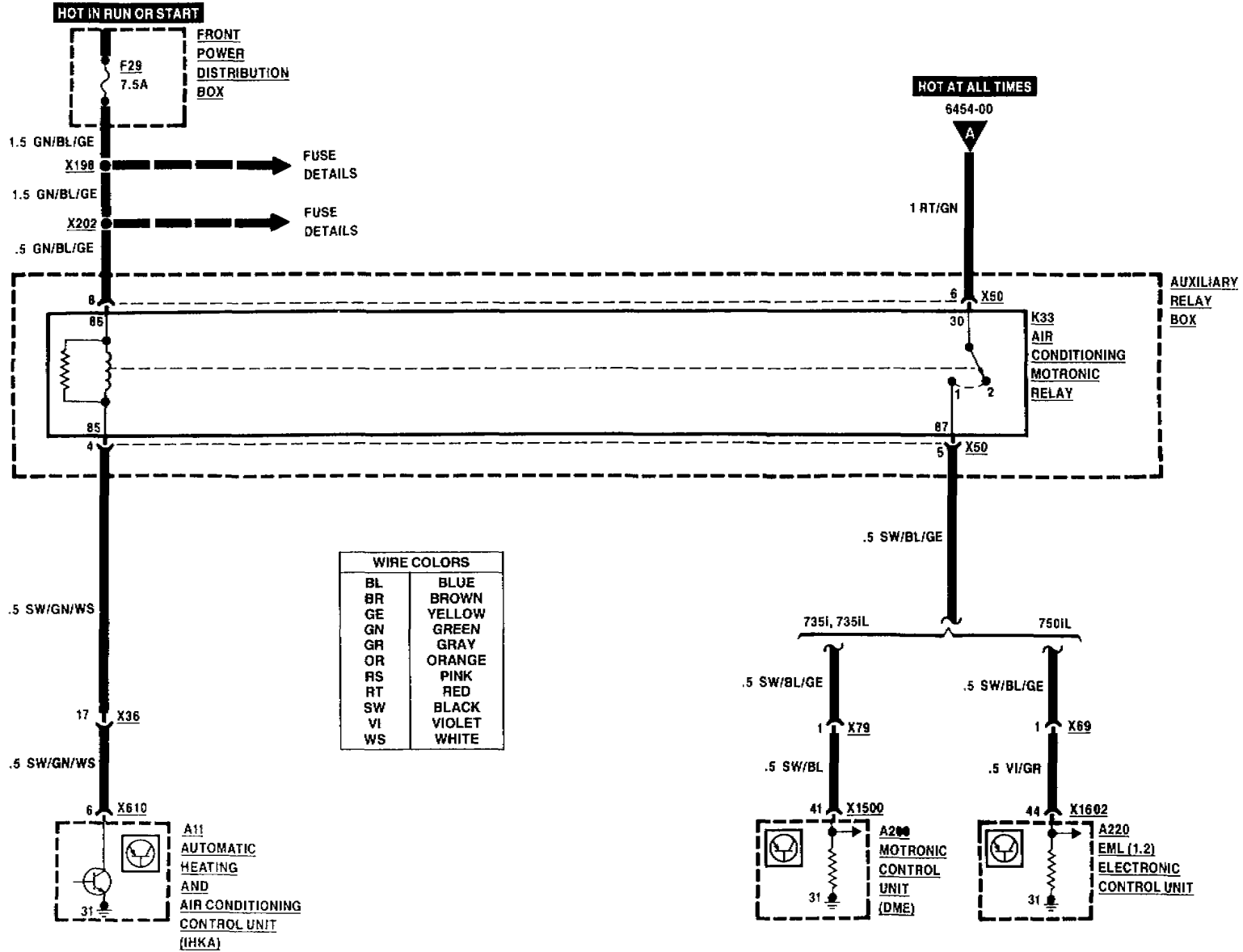



AUXILIARY FAN

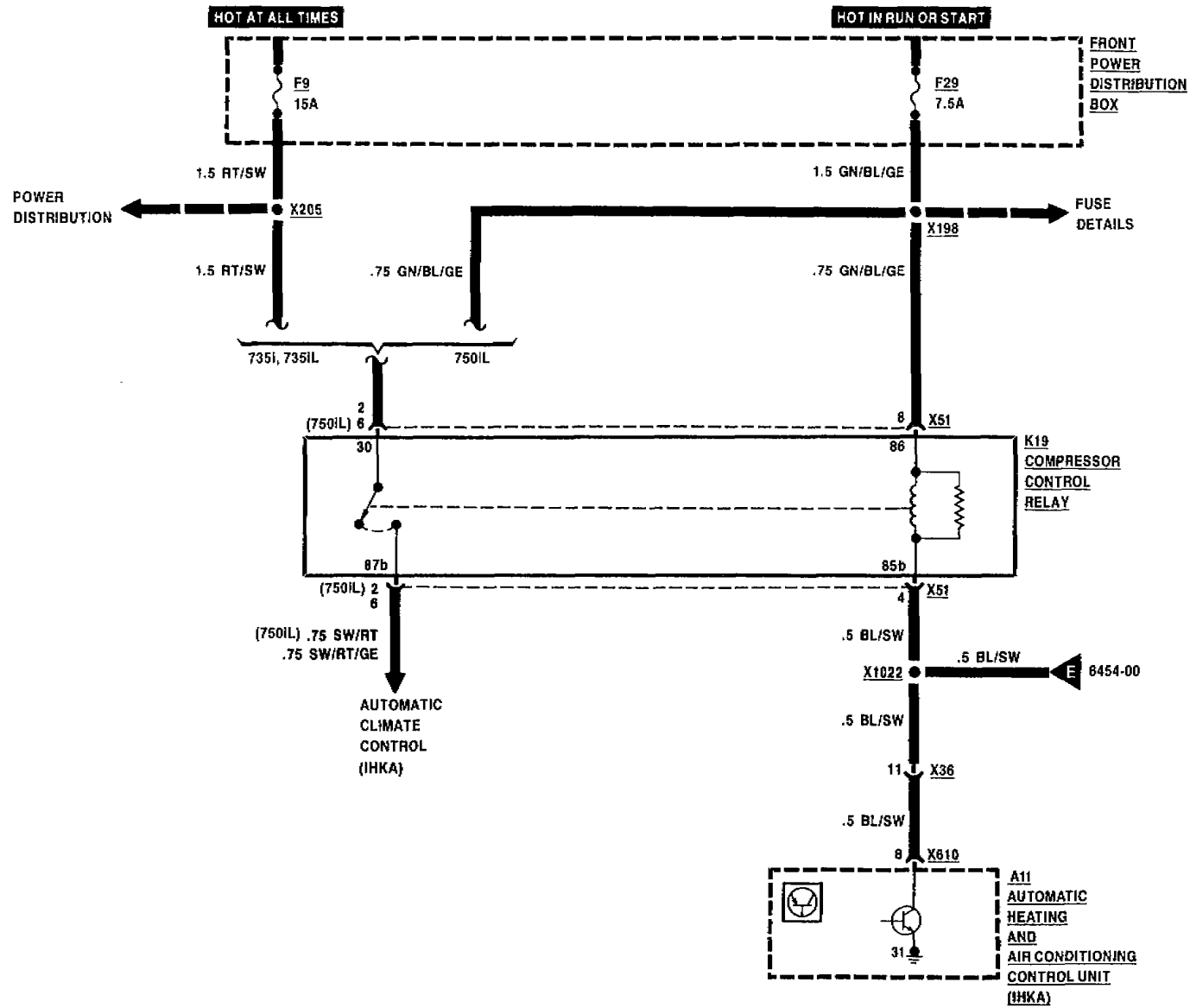



RADIO/CD PLAYER (PROVISIONS)

RADIO/HIFI, TEN SPEAKER SYSTEM

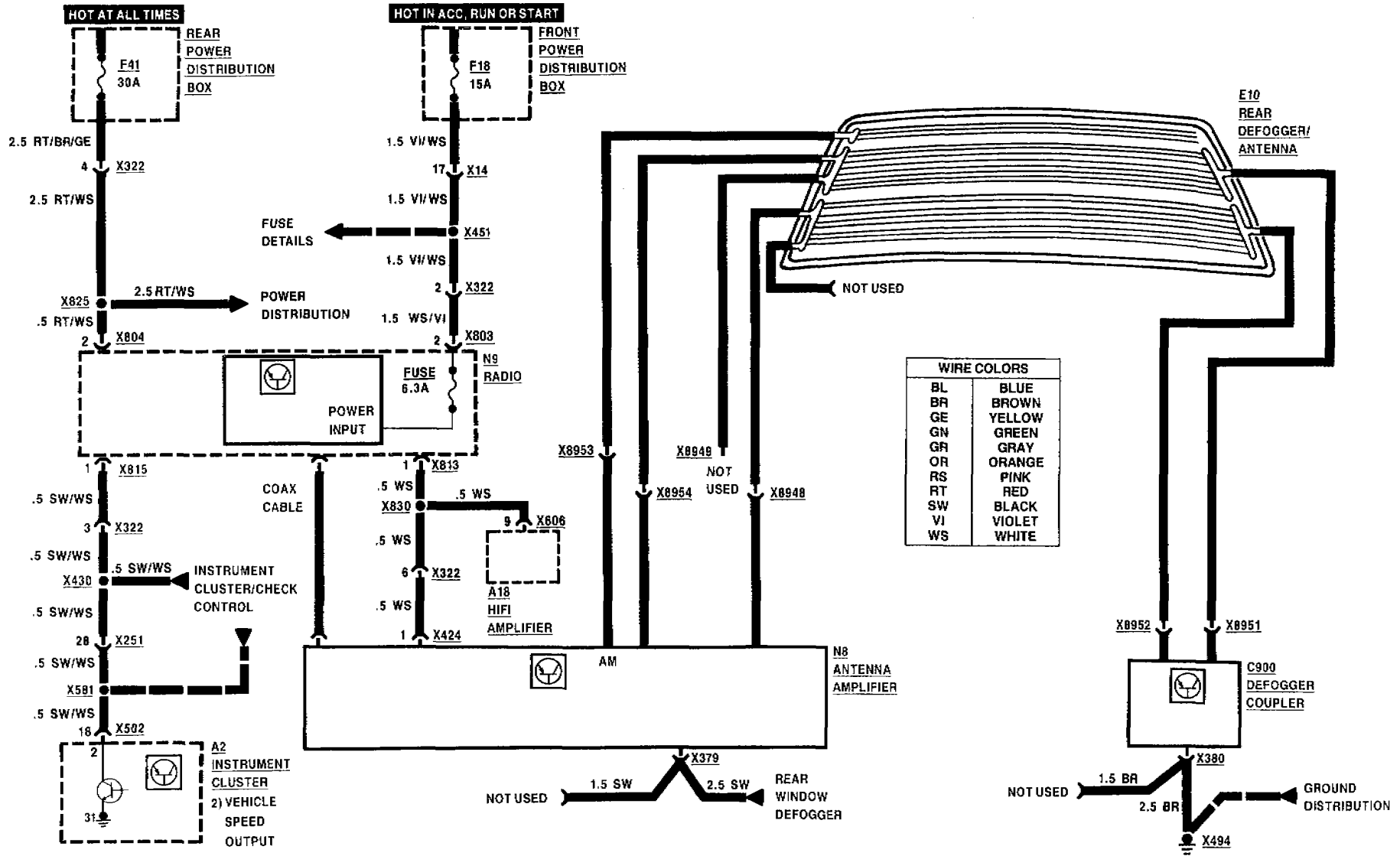



RADIO/CD PLAYER (PROVISIONS)

RADIO/HIFI, TEN SPEAKER SYSTEM

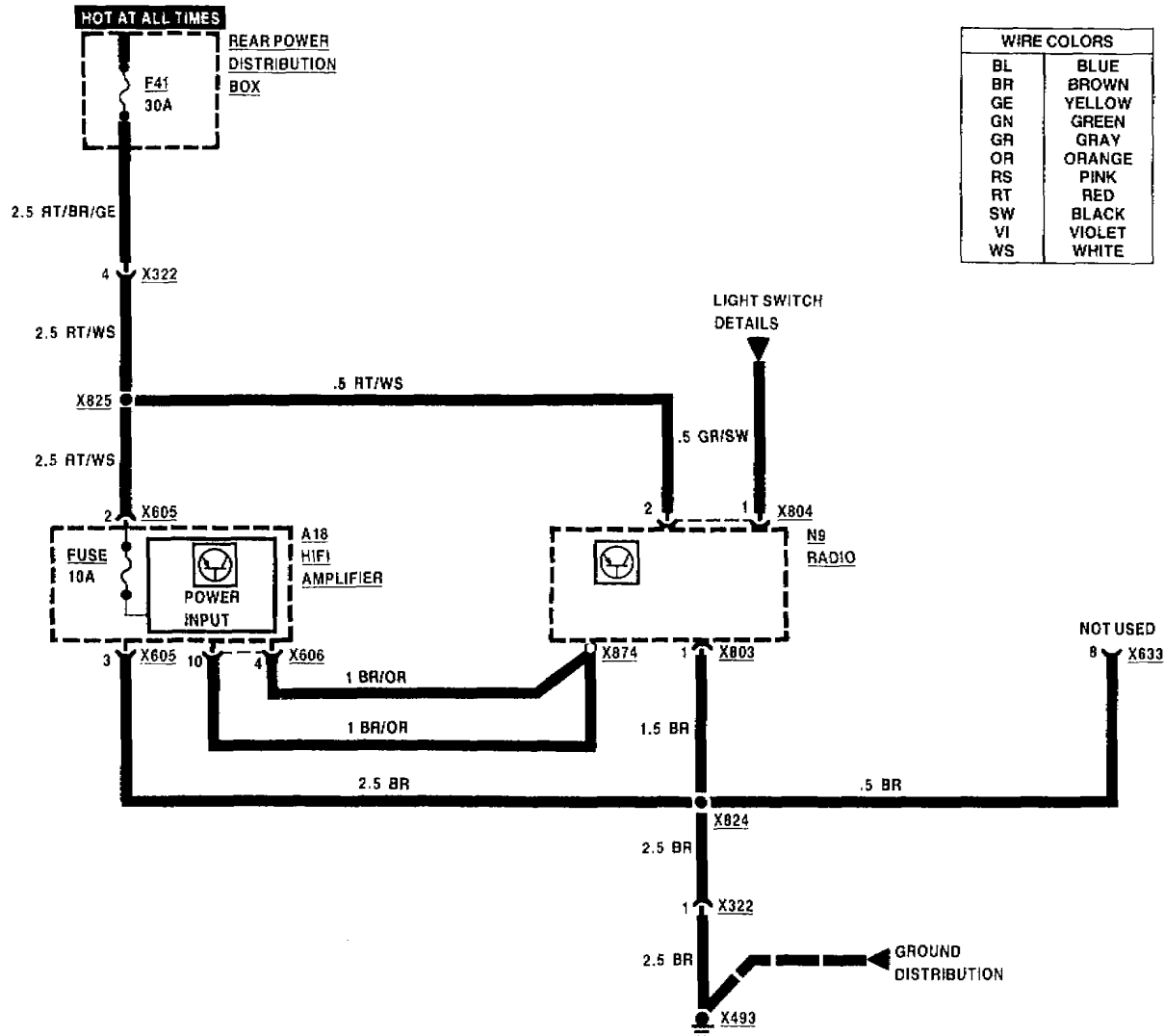



RADIO/CD PLAYER (PROVISIONS)

RADIO/HIFI, TEN SPEAKER SYSTEM

WIRE COLORS	
BL	BLUE
BR	BROWN
GE	YELLOW
GN	GREEN
GR	GRAY
OR	ORANGE
RS	PINK
RT	RED
SW	BLACK
VI	VIOLET
WS	WHITE

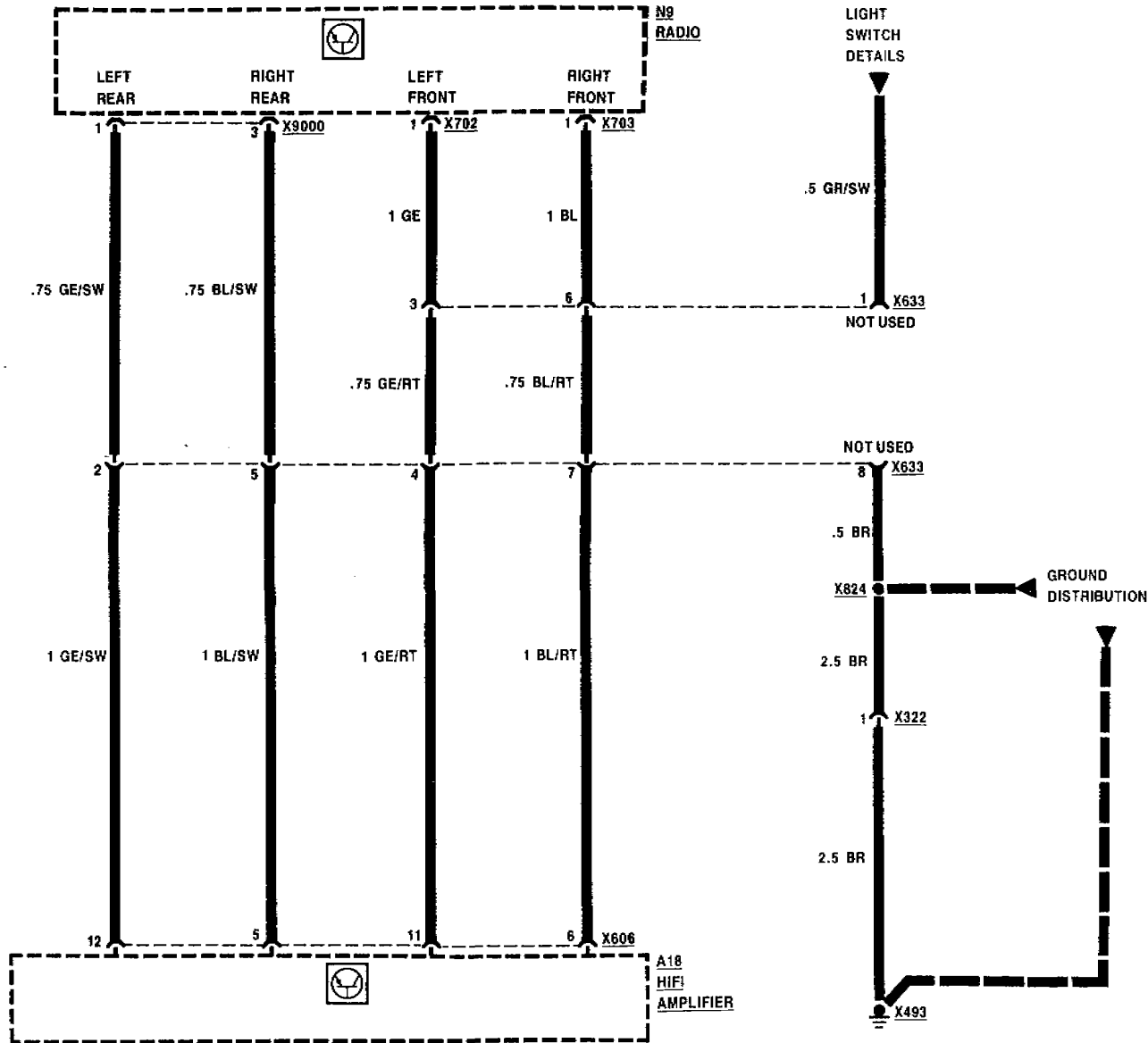



RADIO/CD PLAYER (PROVISIONS)

TEN SPEAKER SYSTEM

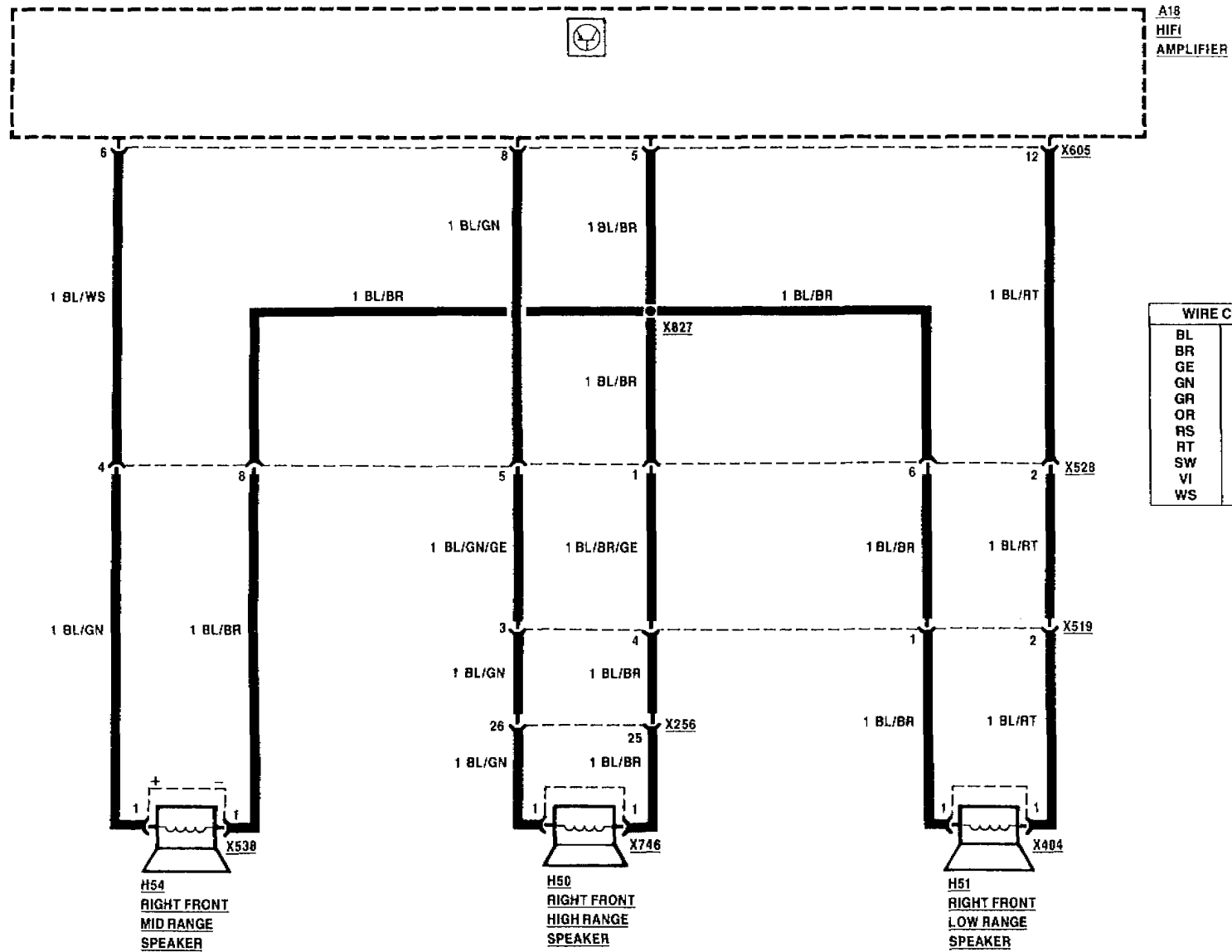



RADIO/CD PLAYER (PROVISIONS)

TEN SPEAKER SYSTEM

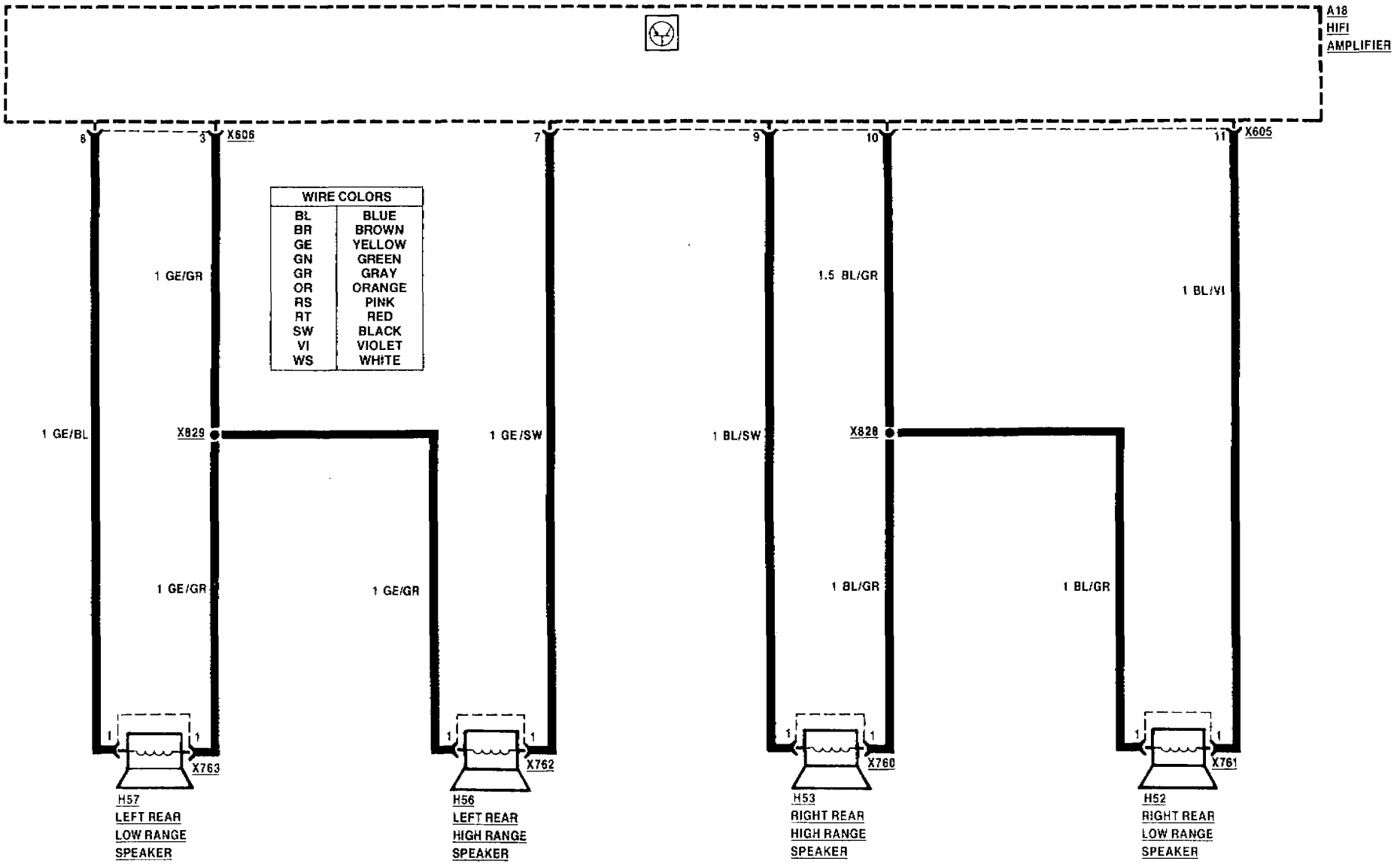



RADIO/CD PLAYER (PROVISIONS) CD CHANGER IF EQUIPPED

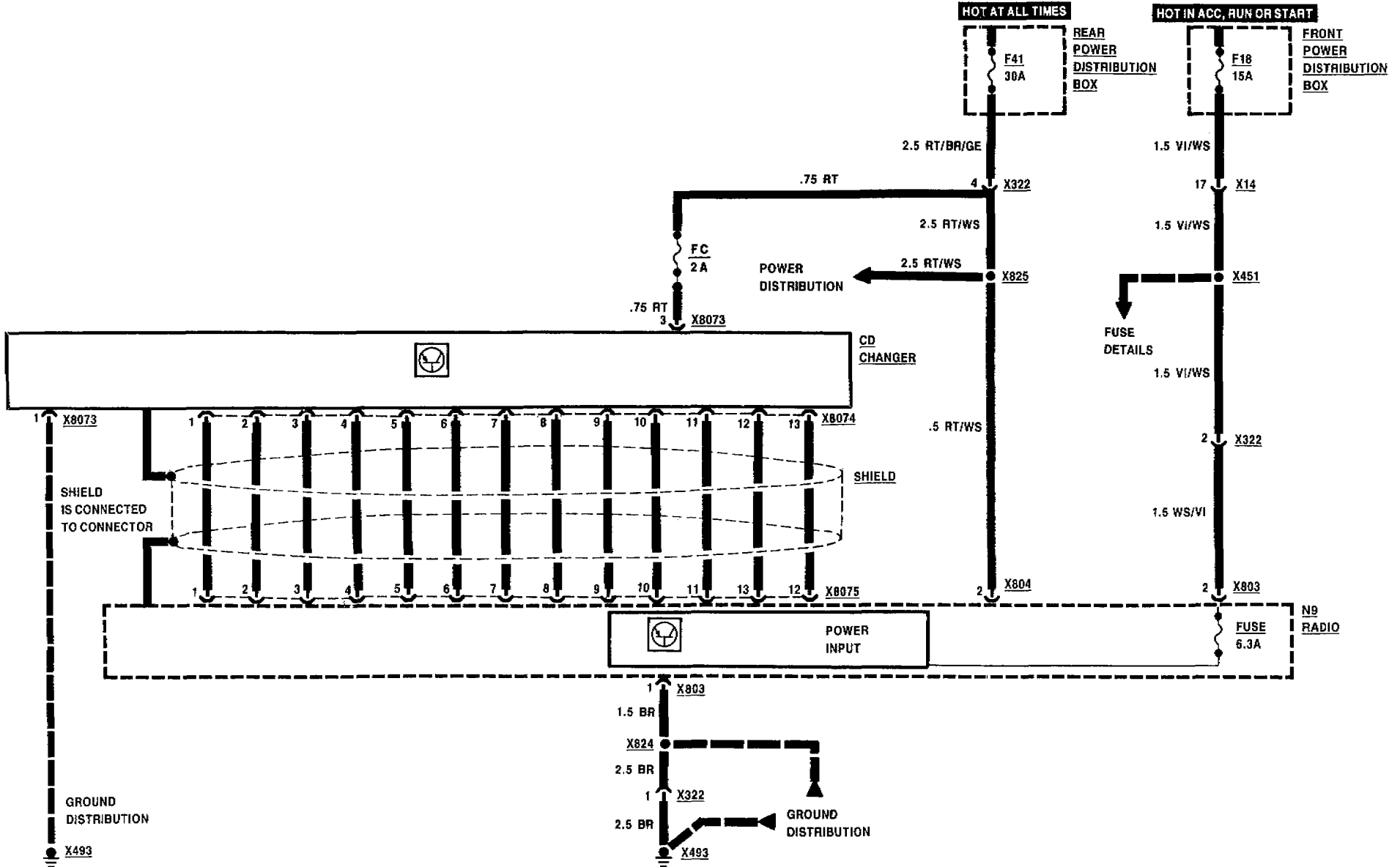

CELLULAR TELEPHONE (PROVISIONS)

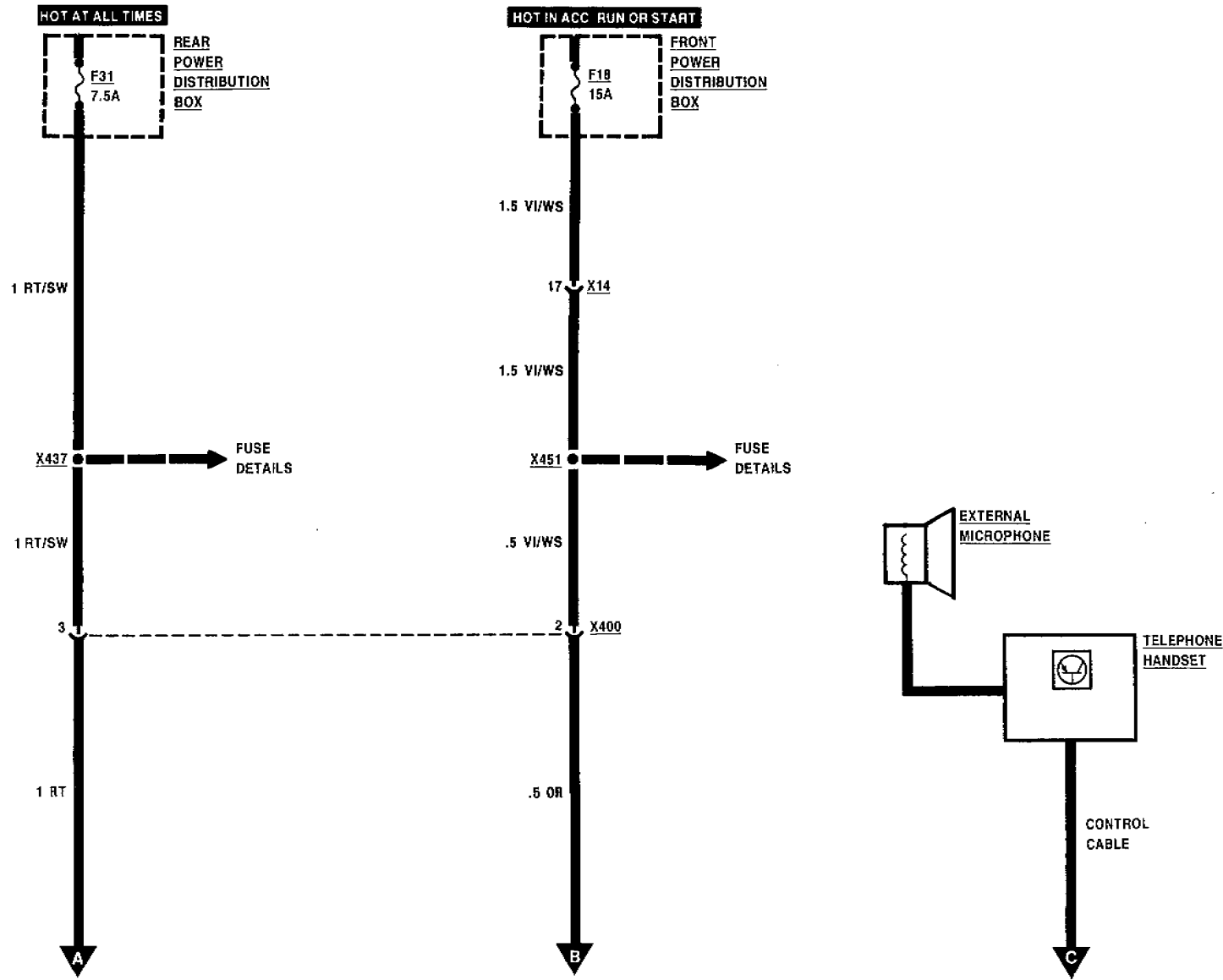

WIRE COLORS	
BL	BLUE
BR	BROWN
GE	YELLOW
GN	GREEN
GR	GRAY
OR	ORANGE
RS	PINK
RT	RED
SW	BLACK
VI	VIOLET
WS	WHITE



CELLULAR TELEPHONE (PROVISIONS)

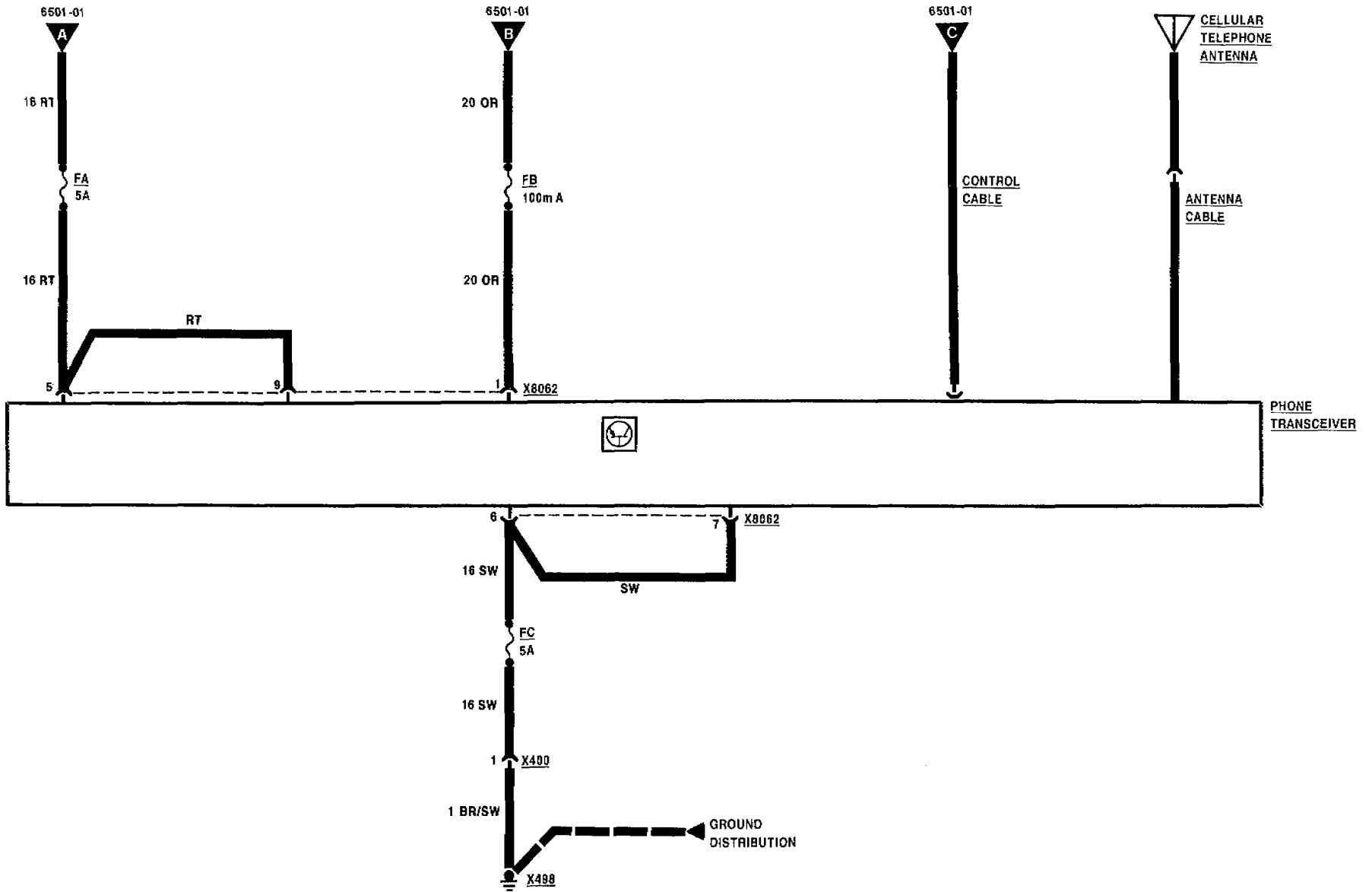



CRUISE CONTROL (TEMPOMAT)

735i, 735iL

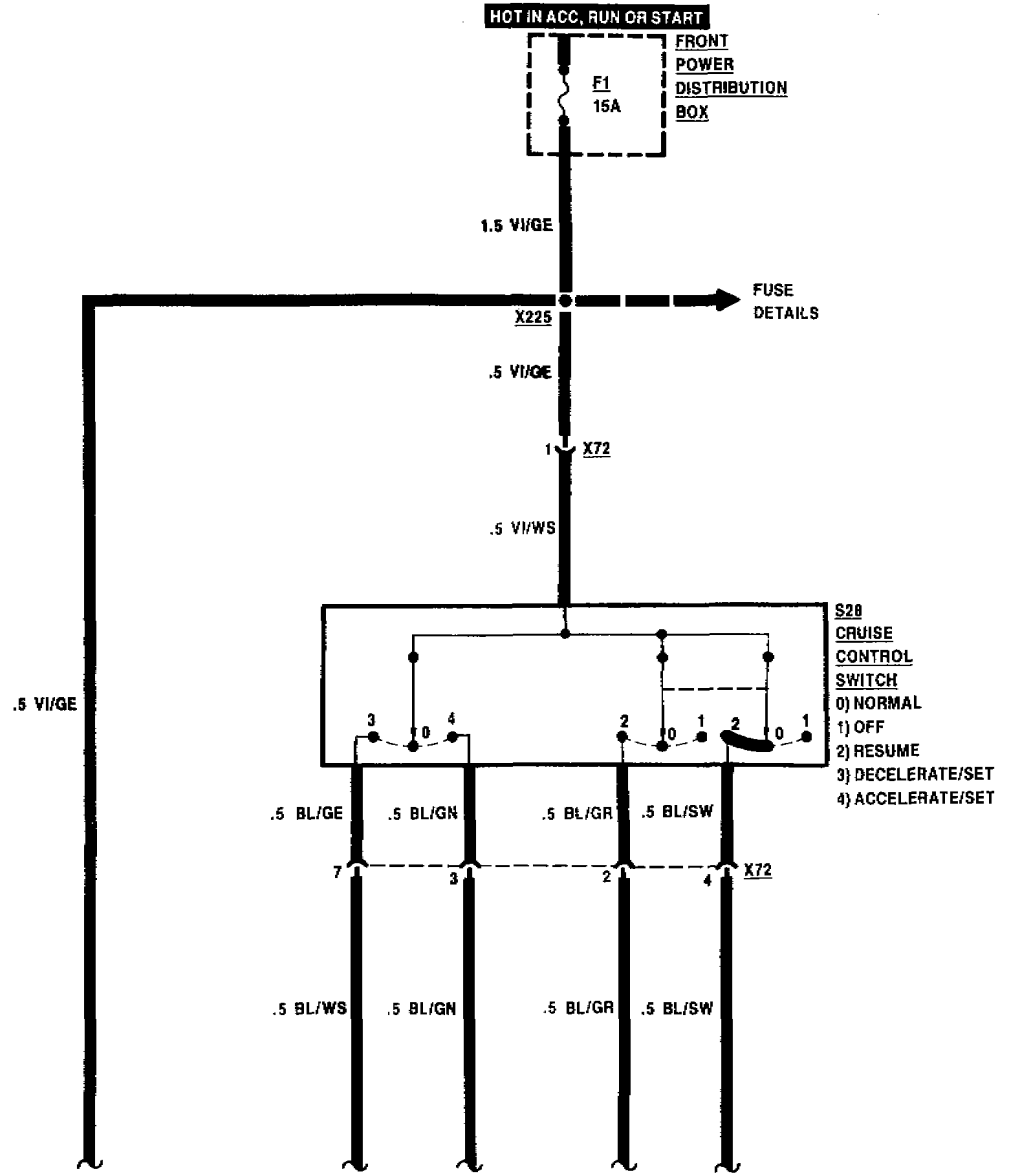
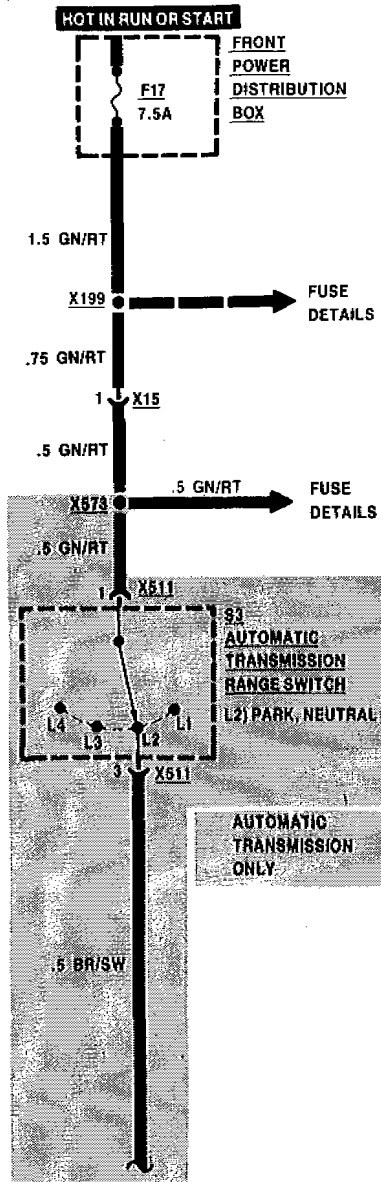

09/88

6571-00

1989



CRUISE CONTROL (TEMPOMAT)

735i, 735iL

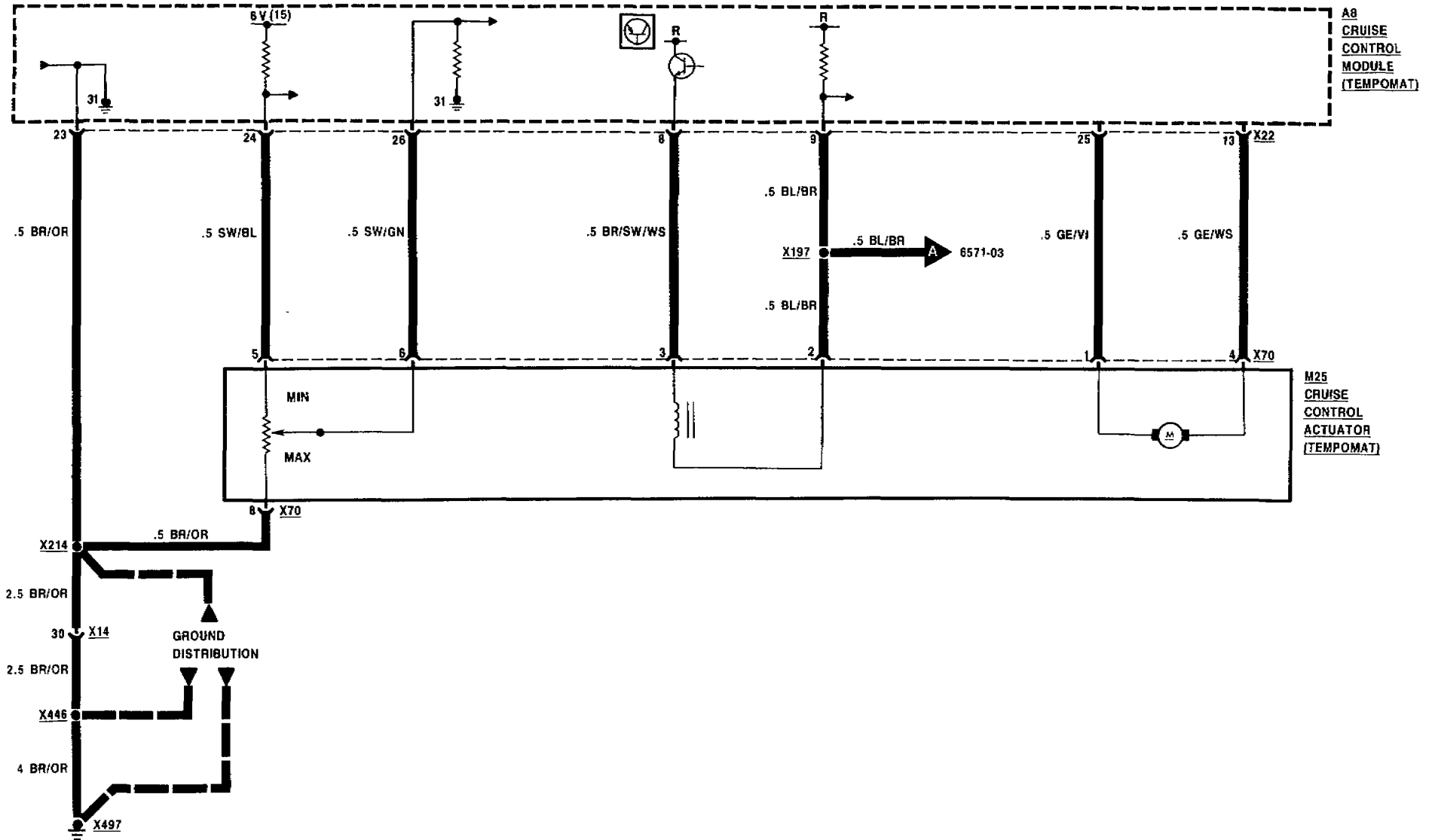

09/88

6571-02

1989



CRUISE CONTROL (TEMPOMAT)

735i, 735iL

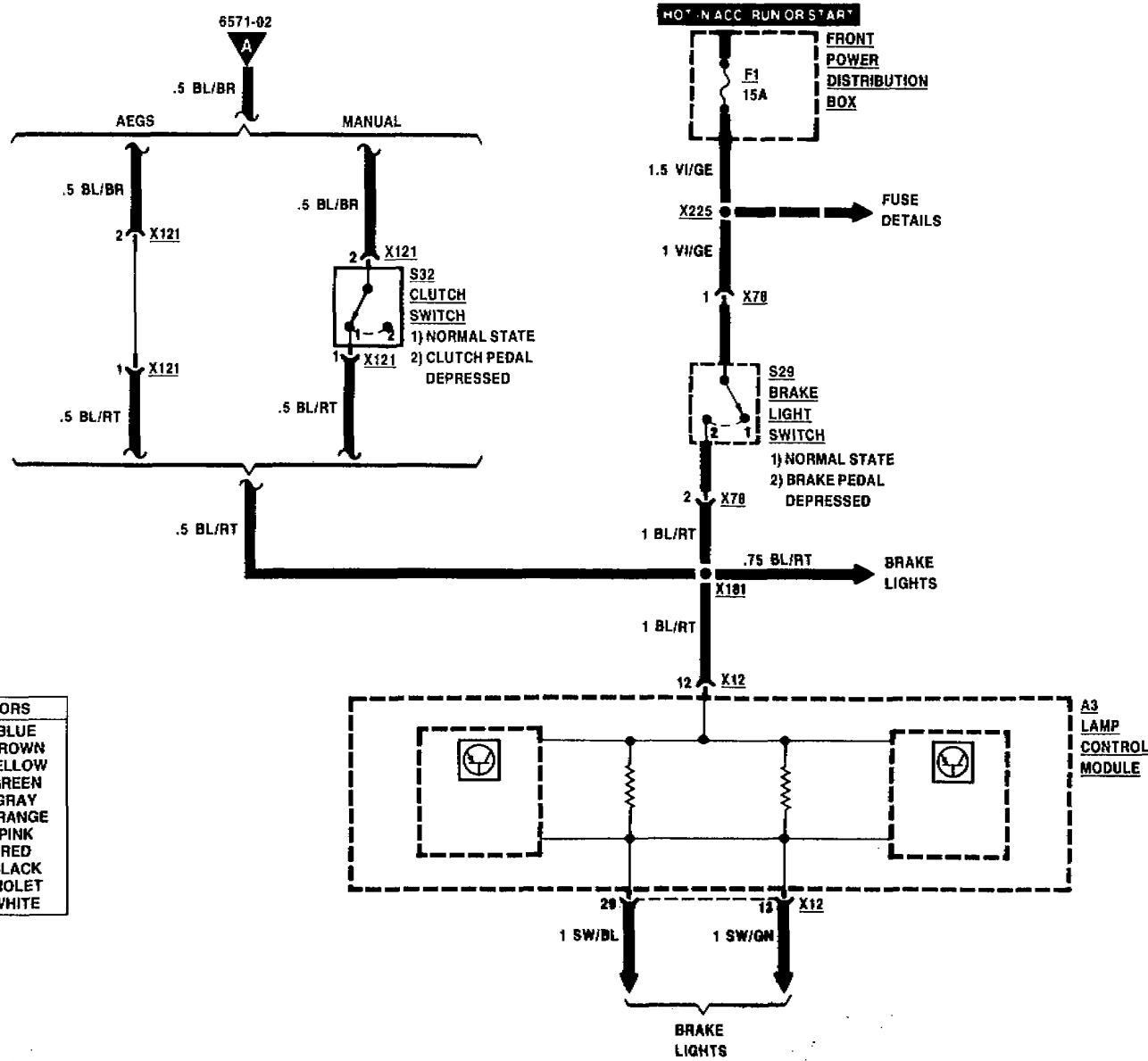

WIRE COLORS	
BL	BLUE
BR	BROWN
GE	YELLOW
GN	GREEN
GR	GRAY
OR	ORANGE
RS	PINK
RT	RED
SW	BLACK
VI	VIOLET
WS	WHITE



CRUISE CONTROL (EML)

750iL

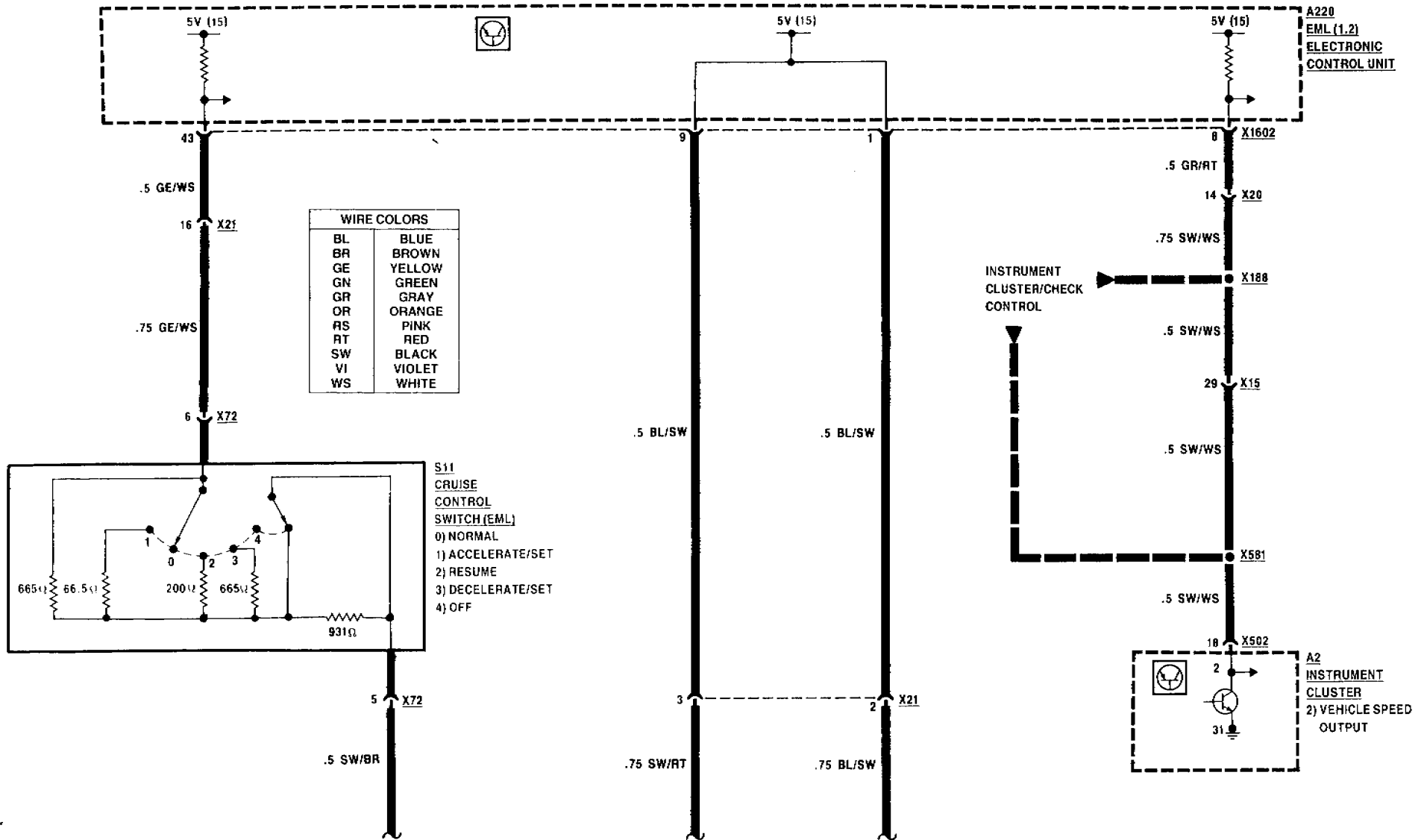

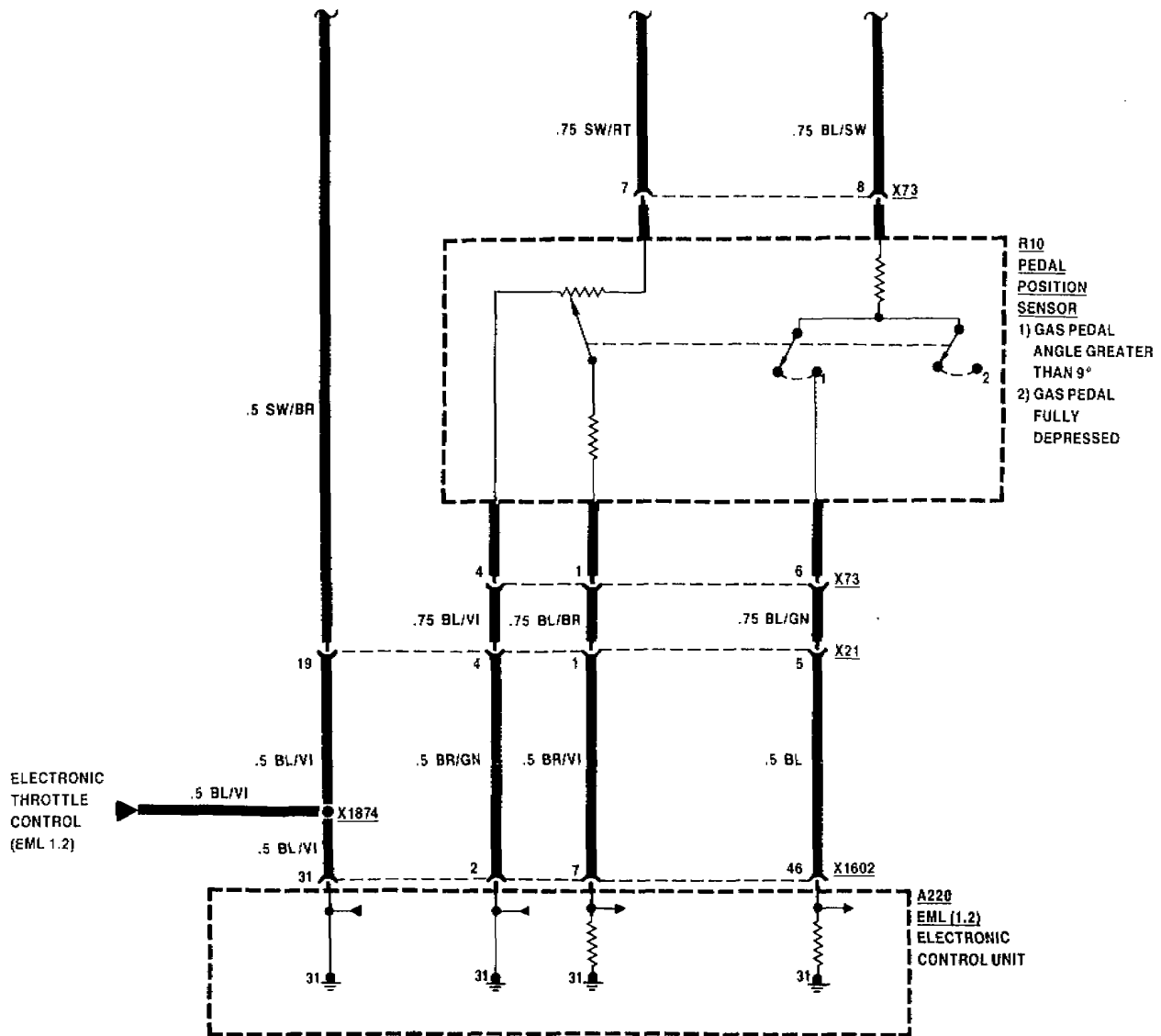



CRUISE CONTROL (EML)

750iL

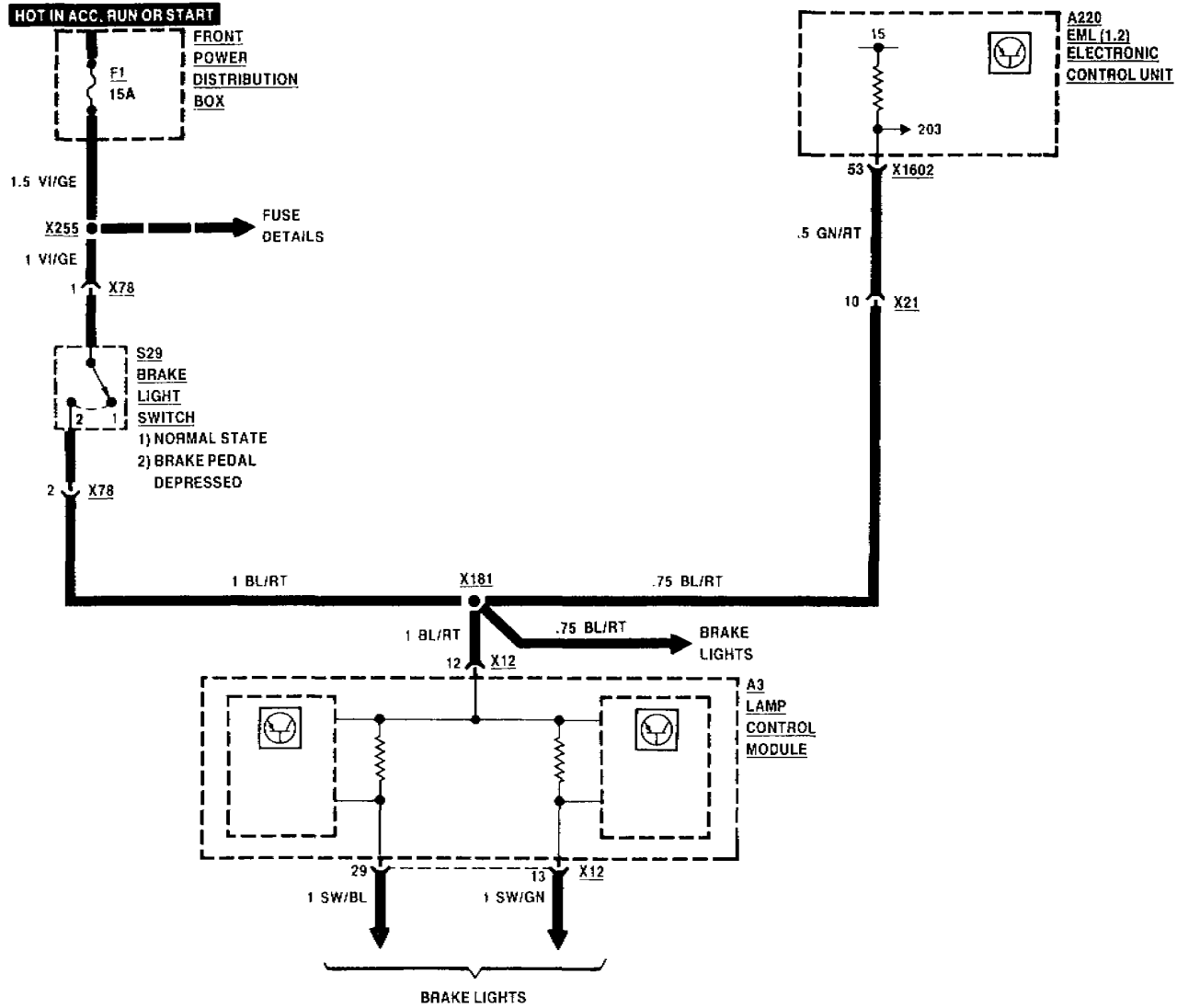

WIRE COLORS	
BL	BLUE
BR	BROWN
GE	YELLOW
GN	GREEN
GR	GRAY
OR	ORANGE
RS	PINK
RT	RED
SW	BLACK
VI	VIOLET
WS	WHITE



ANTITHEFT SYSTEM (DWA)

POWER, TRUNK INPUT

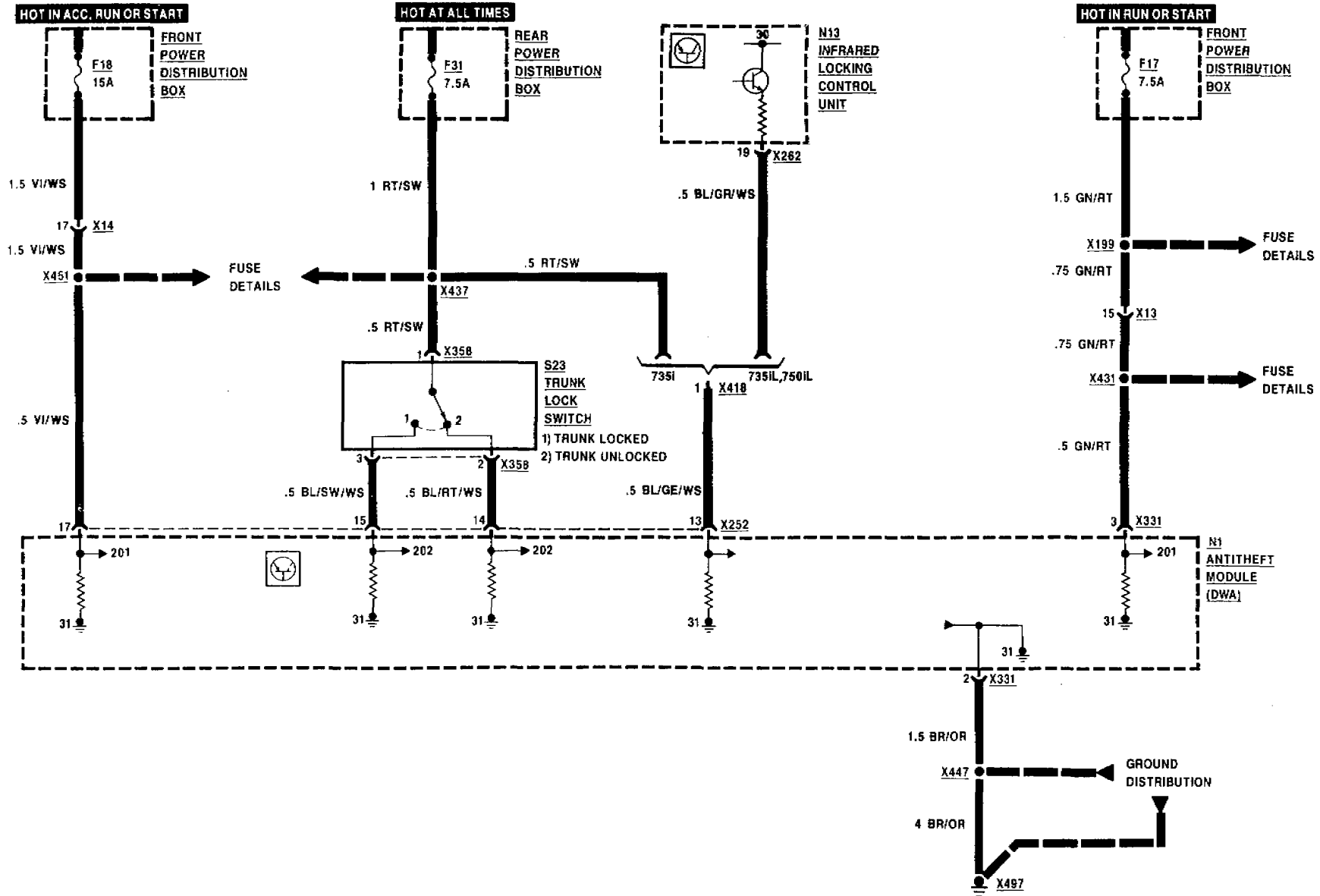



ANTITHEFT SYSTEM (DWA)

TRUNK INPUT, ANTITHEFT HORN

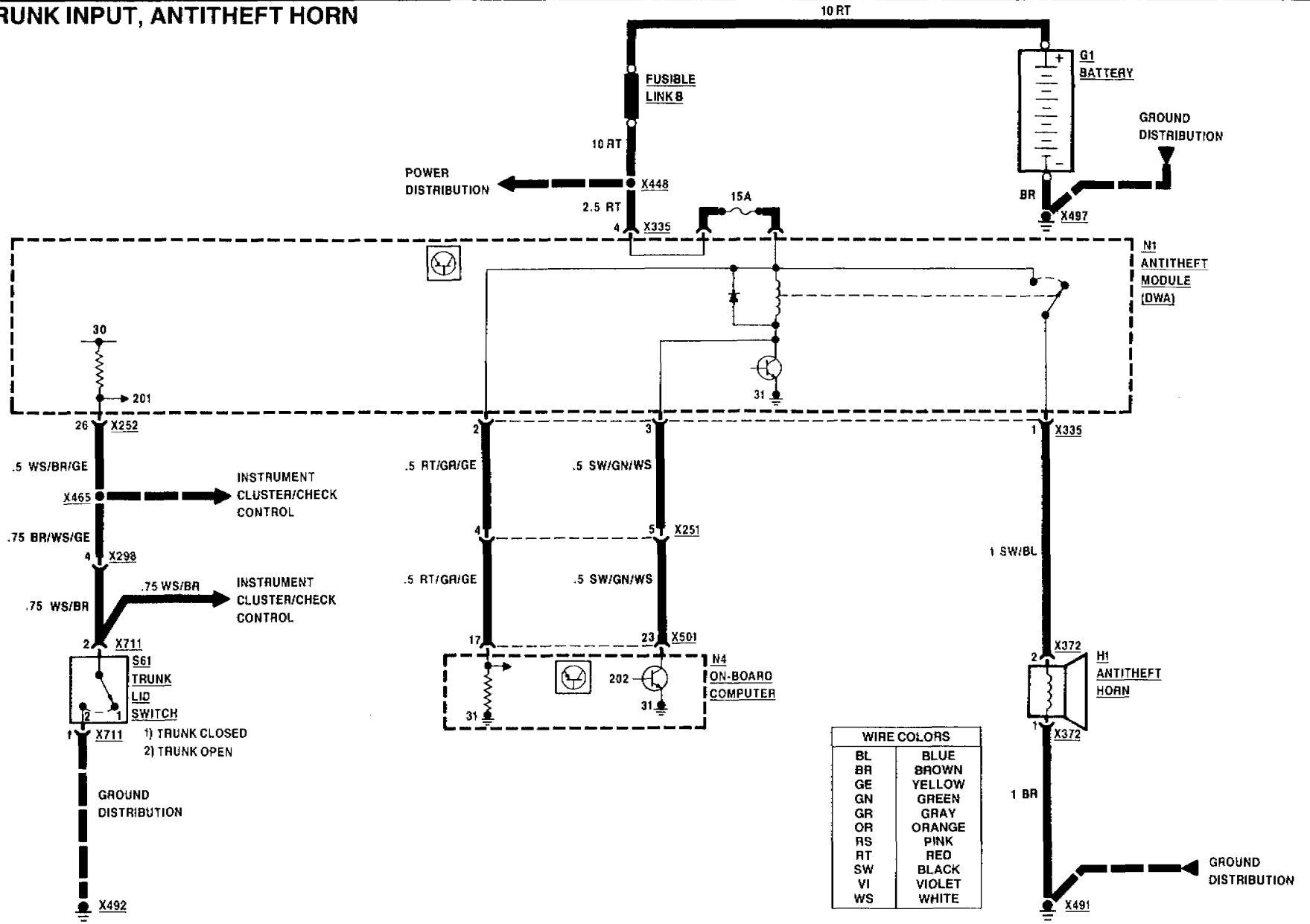



ANTITHEFT SYSTEM (DWA)

DIAGNOSTIC LINK, DRIVE AWAY PROTECTION, QZV

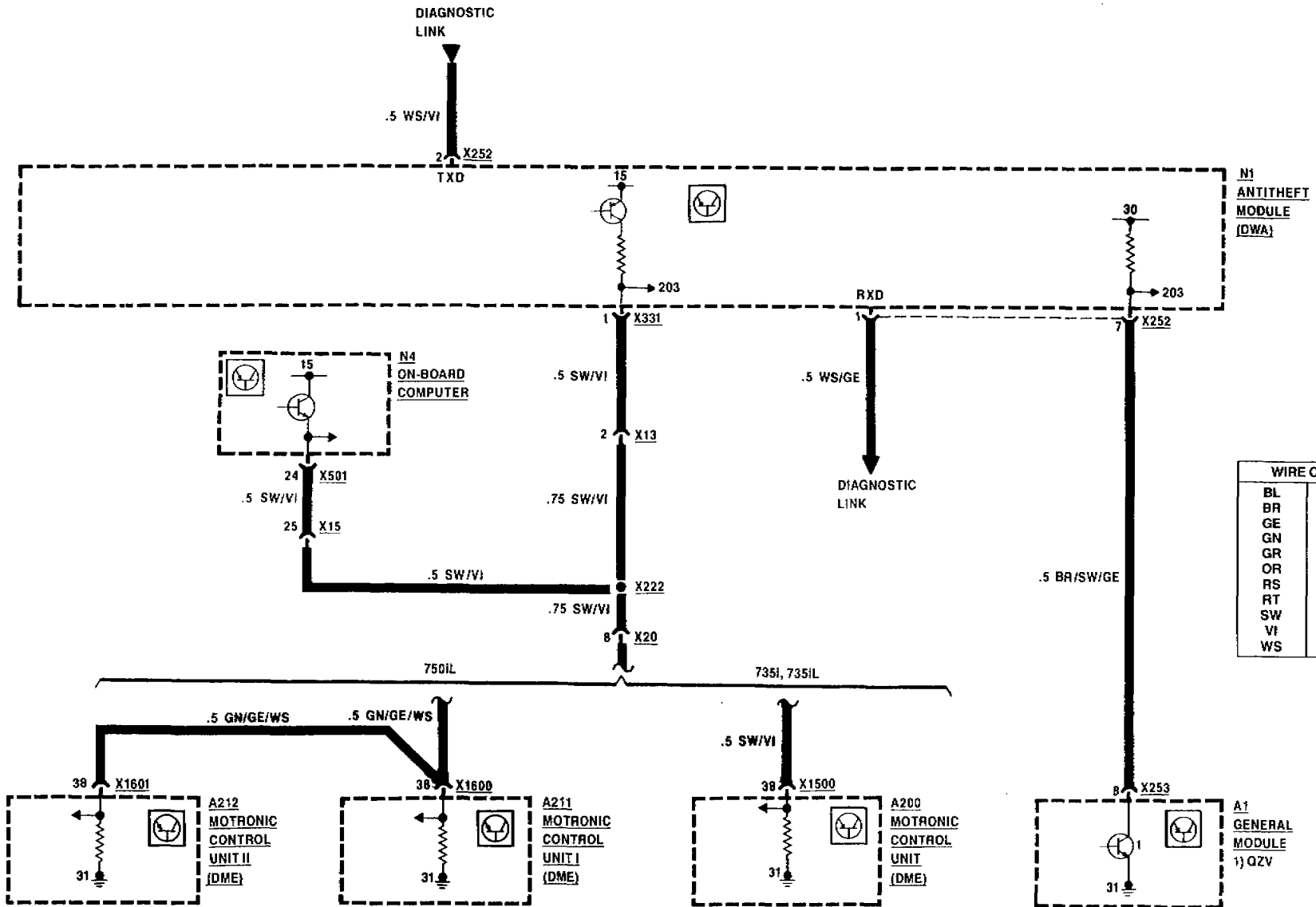

WIRE COLORS	
BL	BLUE
BR	BROWN
GE	YELLOW
GN	GREEN
GR	GRAY
OR	ORANGE
RS	PINK
RT	RED
SW	BLACK
VI	VIOLET
WS	WHITE



ANTITHEFT SYSTEM (DWA)

FRONT DOOR JAMB SWITCHES

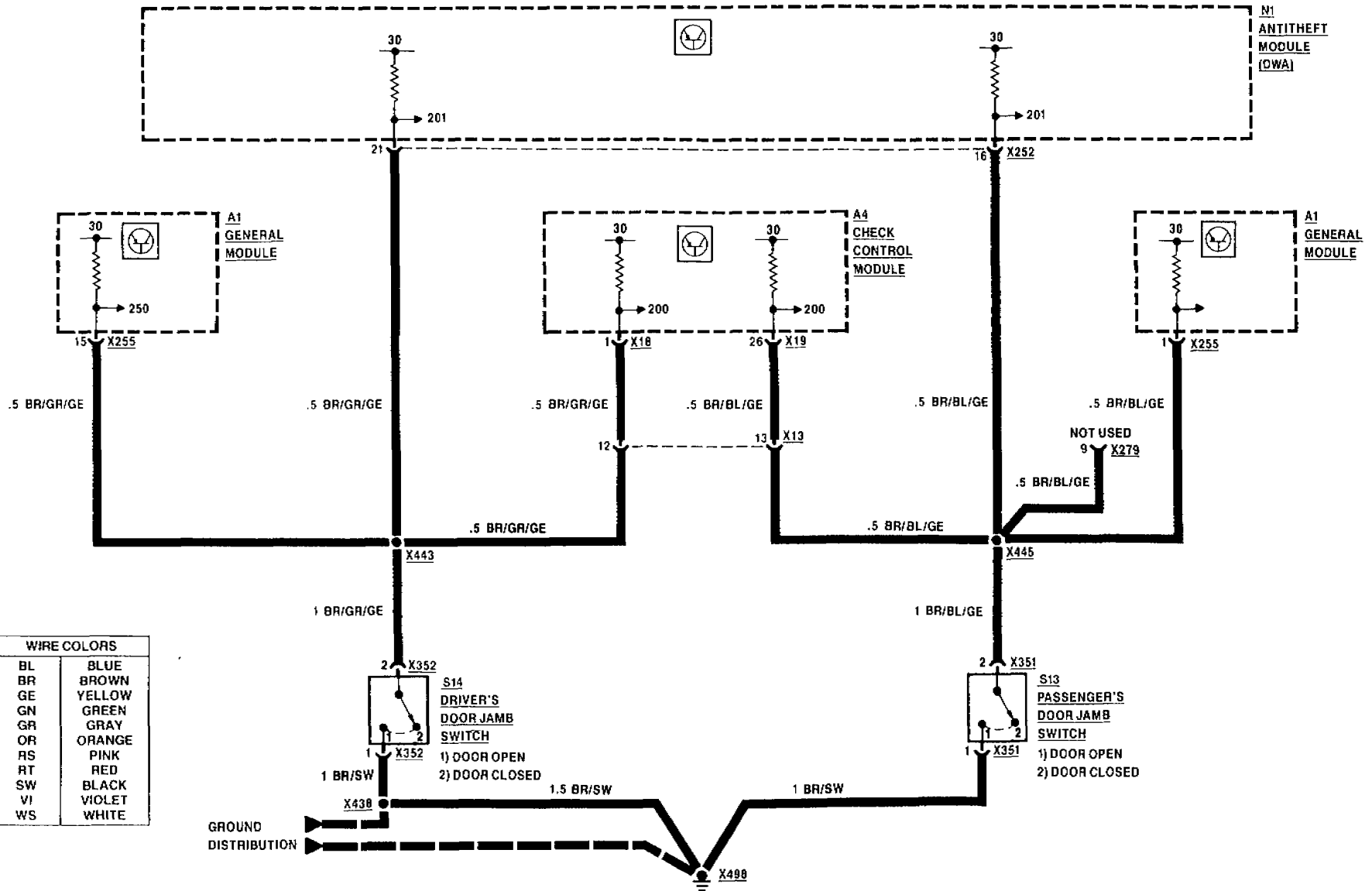

WIRE COLORS	
BL	BLUE
BR	BROWN
GE	YELLOW
GN	GREEN
GR	GRAY
OR	ORANGE
RS	PINK
RT	RED
SW	BLACK
VI	VIOLET
WS	WHITE



ANTITHEFT SYSTEM (DWA)

INDICATOR, PASSENGER'S DOOR INPUTS, LIGHT ALARM OUTPUT

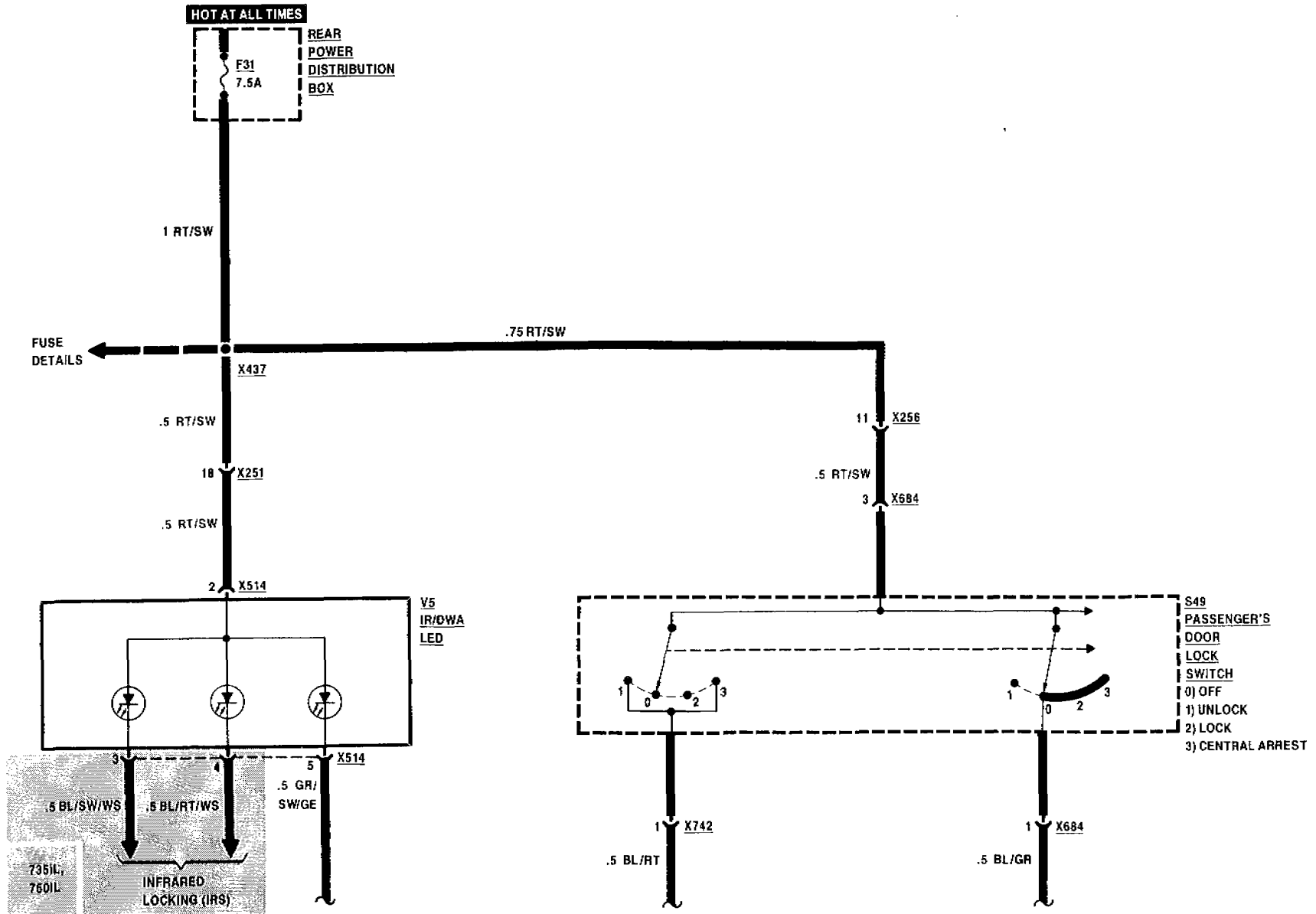

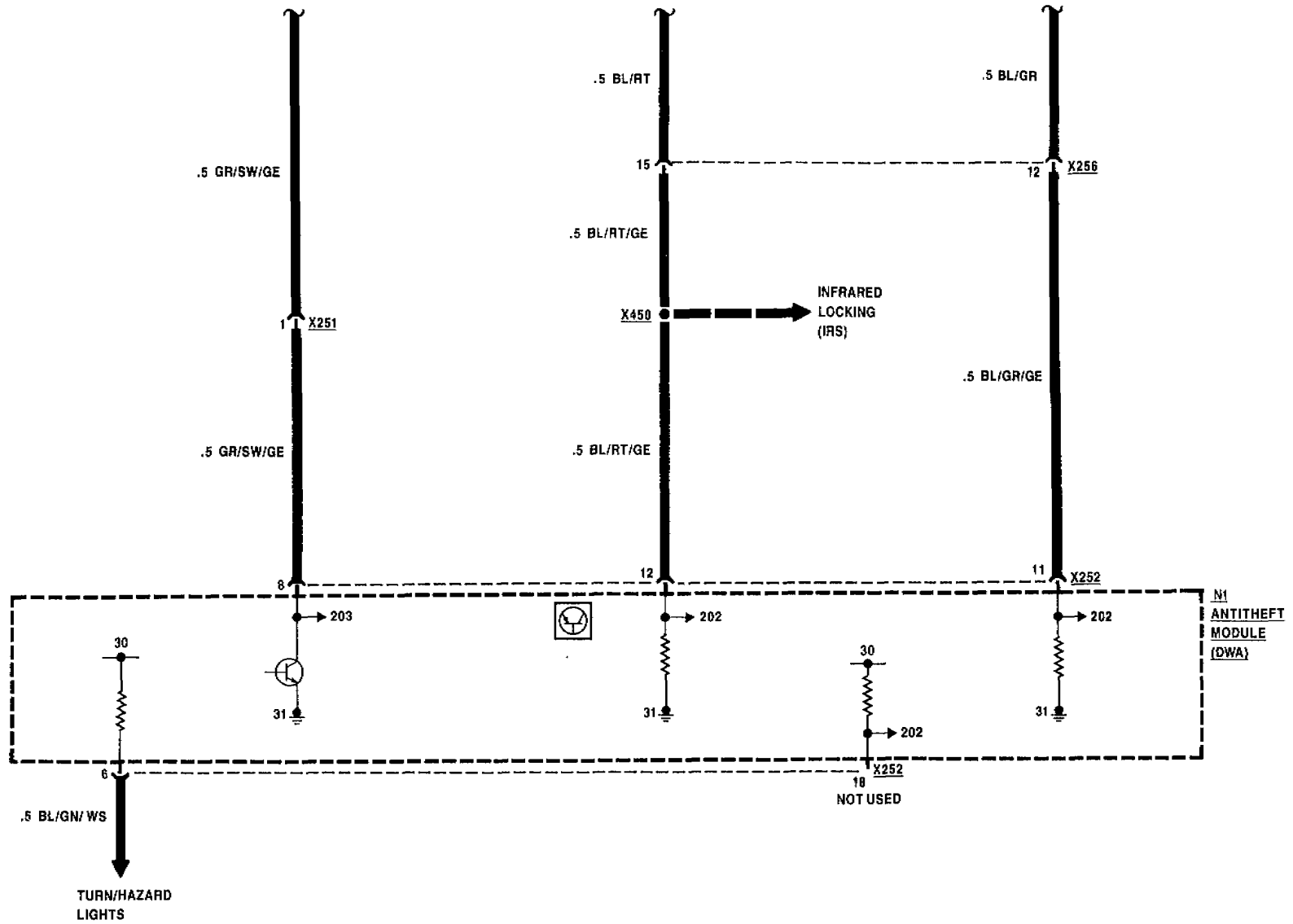



ANTITHEFT SYSTEM (DWA) REAR DOOR PROTECTION

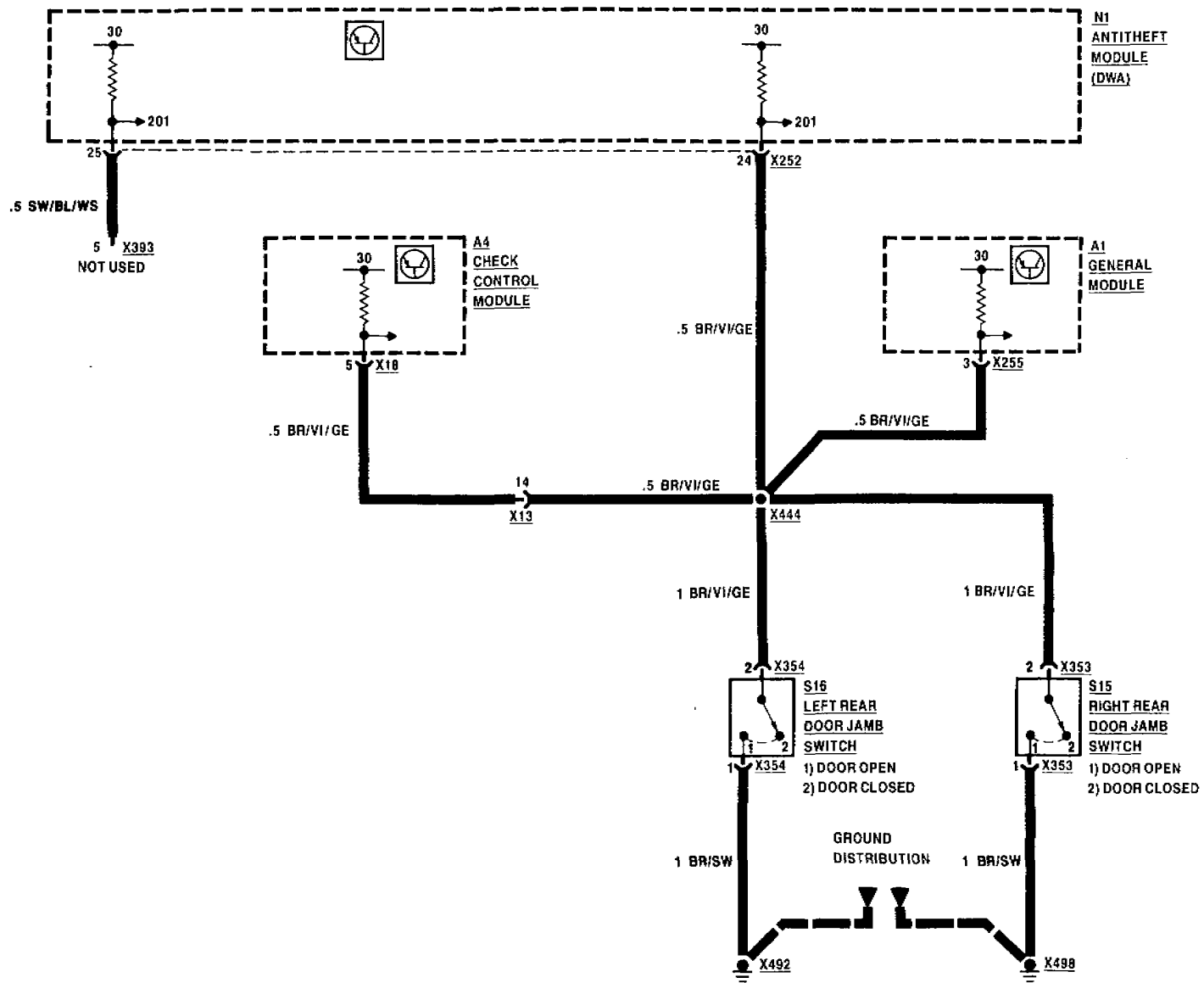



ANTITHEFT SYSTEM (DWA)

GLOVE BOX, RADIO, ENGINE HOOD INPUTS

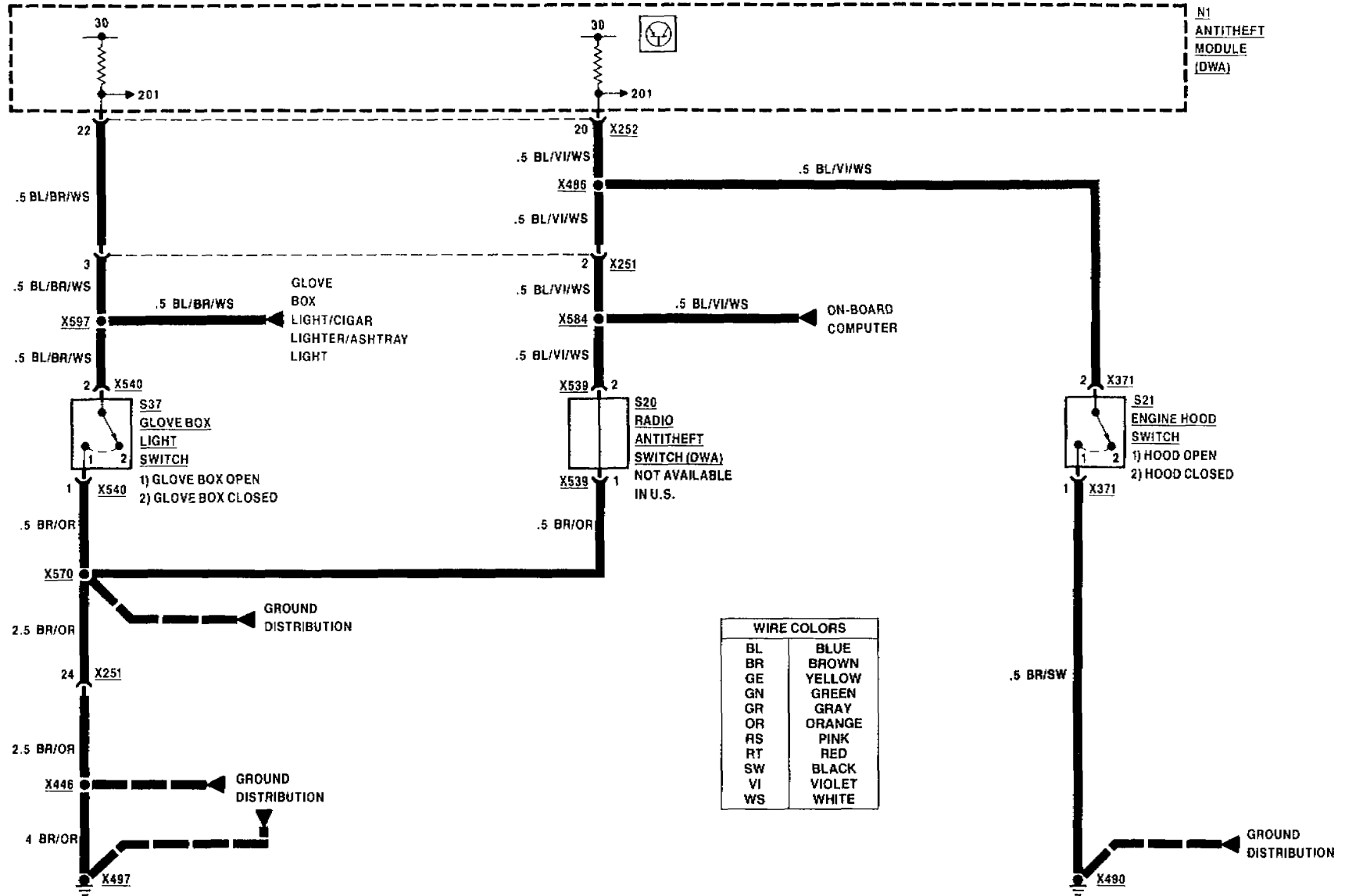



ANTITHEFT SYSTEM (DWA)

ENGINE RUNNING INPUT, DRIVER'S DOOR INPUTS

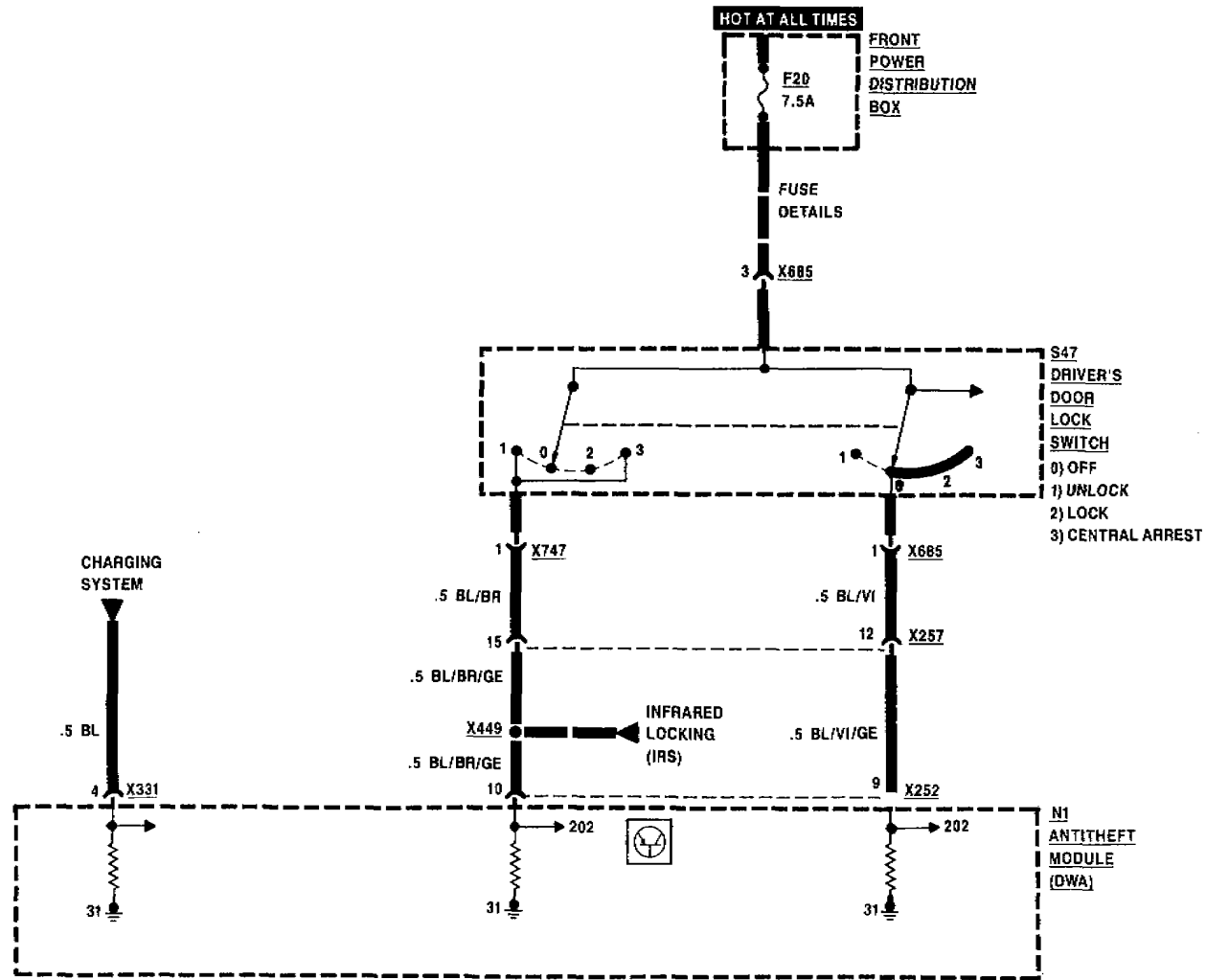

WIRE COLORS	
BL	BLUE
BR	BROWN
GE	YELLOW
GN	GREEN
GR	GRAY
OR	ORANGE
RS	PINK
RT	RED
SW	BLACK
VI	VIOLET
WS	WHITE

09/88 ————— 6575-08 ————— 1989



ANTITHEFT SYSTEM (DWA)

BATTERY, REAR SEAT, MOTION INPUTS

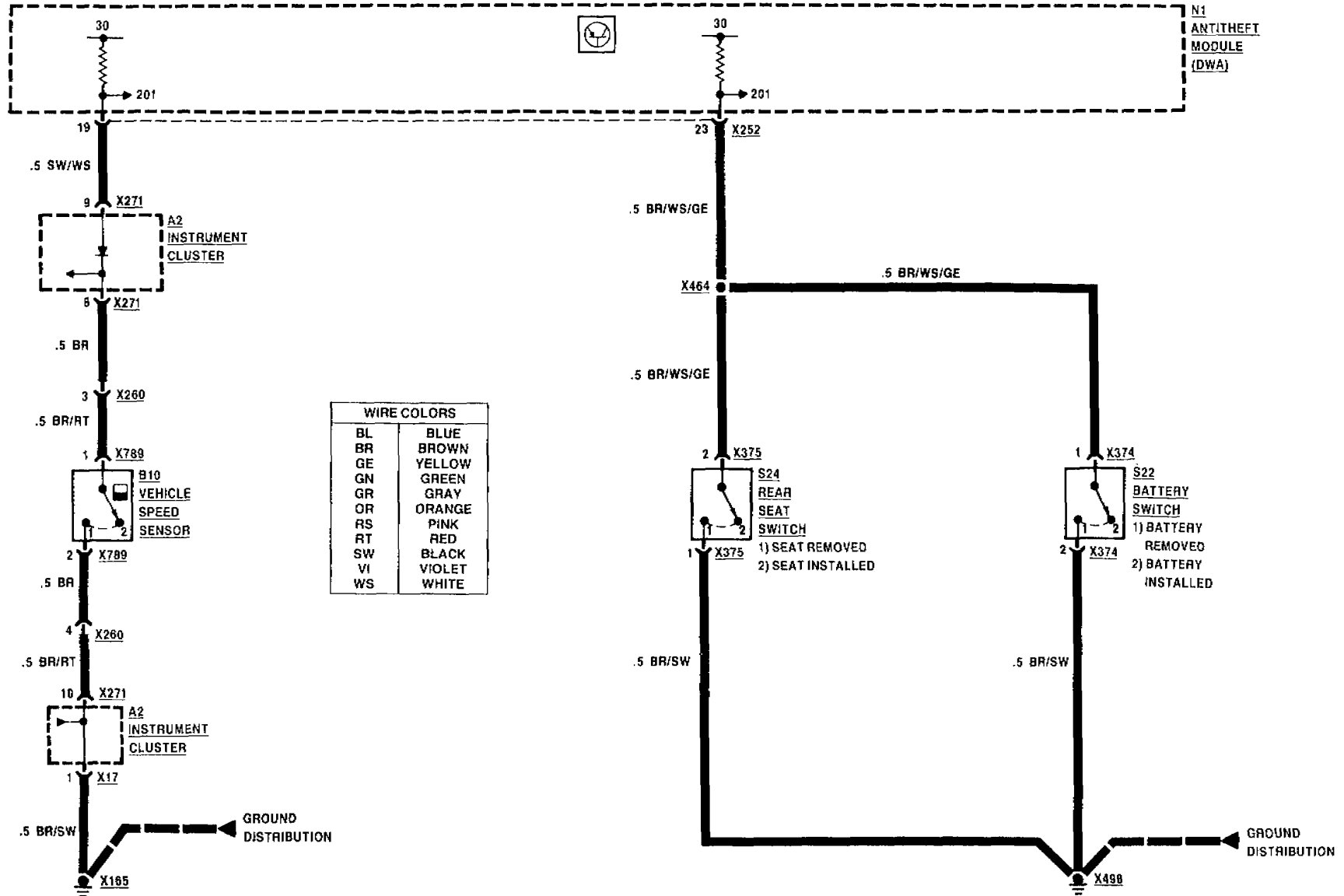

WIRE COLORS	
BL	BLUE
BR	BROWN
GE	YELLOW
GN	GREEN
GR	GRAY
OR	ORANGE
RS	PINK
RT	RED
SW	BLACK
VI	VIOLET
WS	WHITE



ON-BOARD COMPUTER

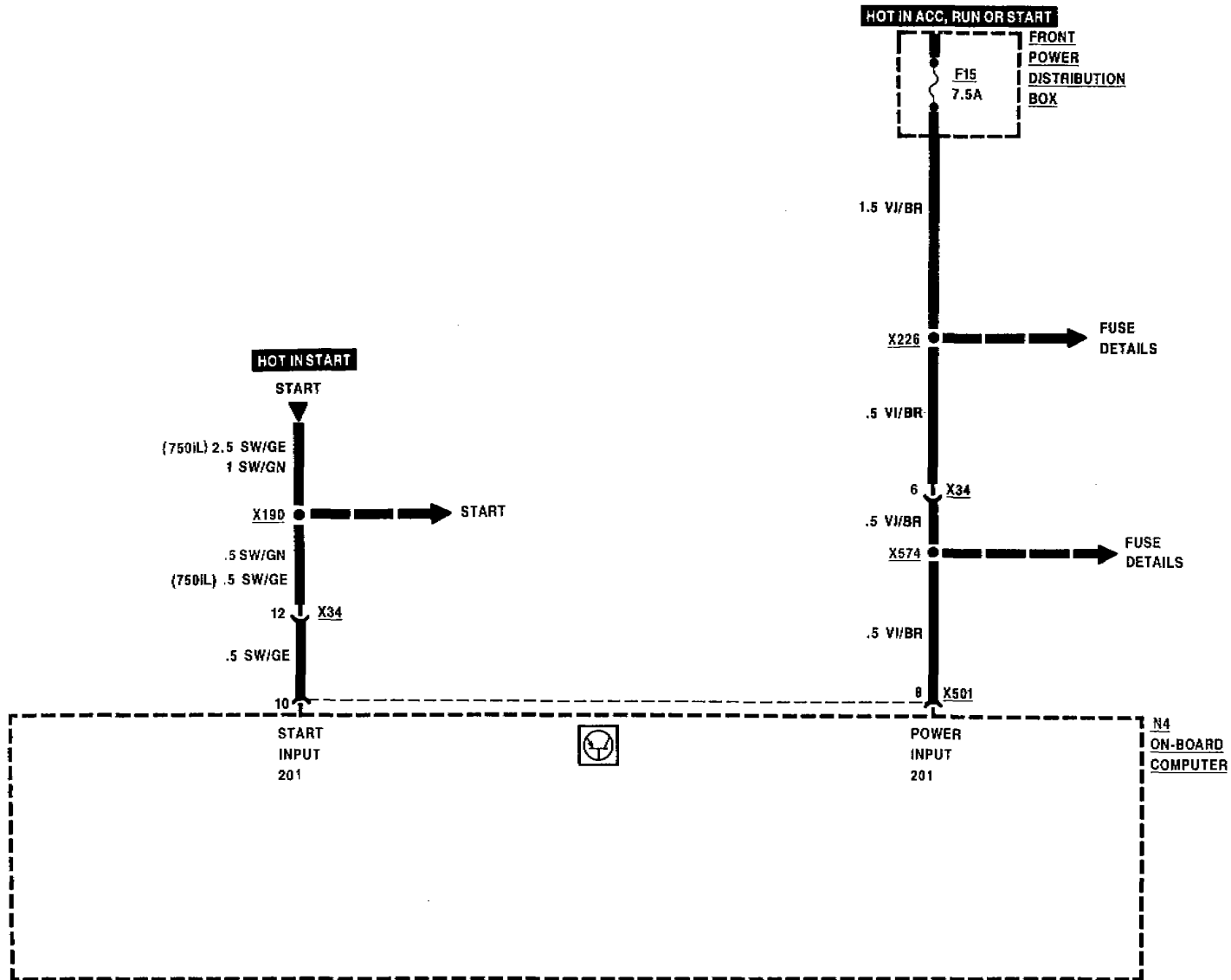

WIRE COLORS	
BL	BLUE
BR	BROWN
GE	YELLOW
GN	GREEN
GR	GRAY
OR	ORANGE
RS	PINK
RT	RED
SW	BLACK
VI	VIOLET
WS	WHITE



ON-BOARD COMPUTER

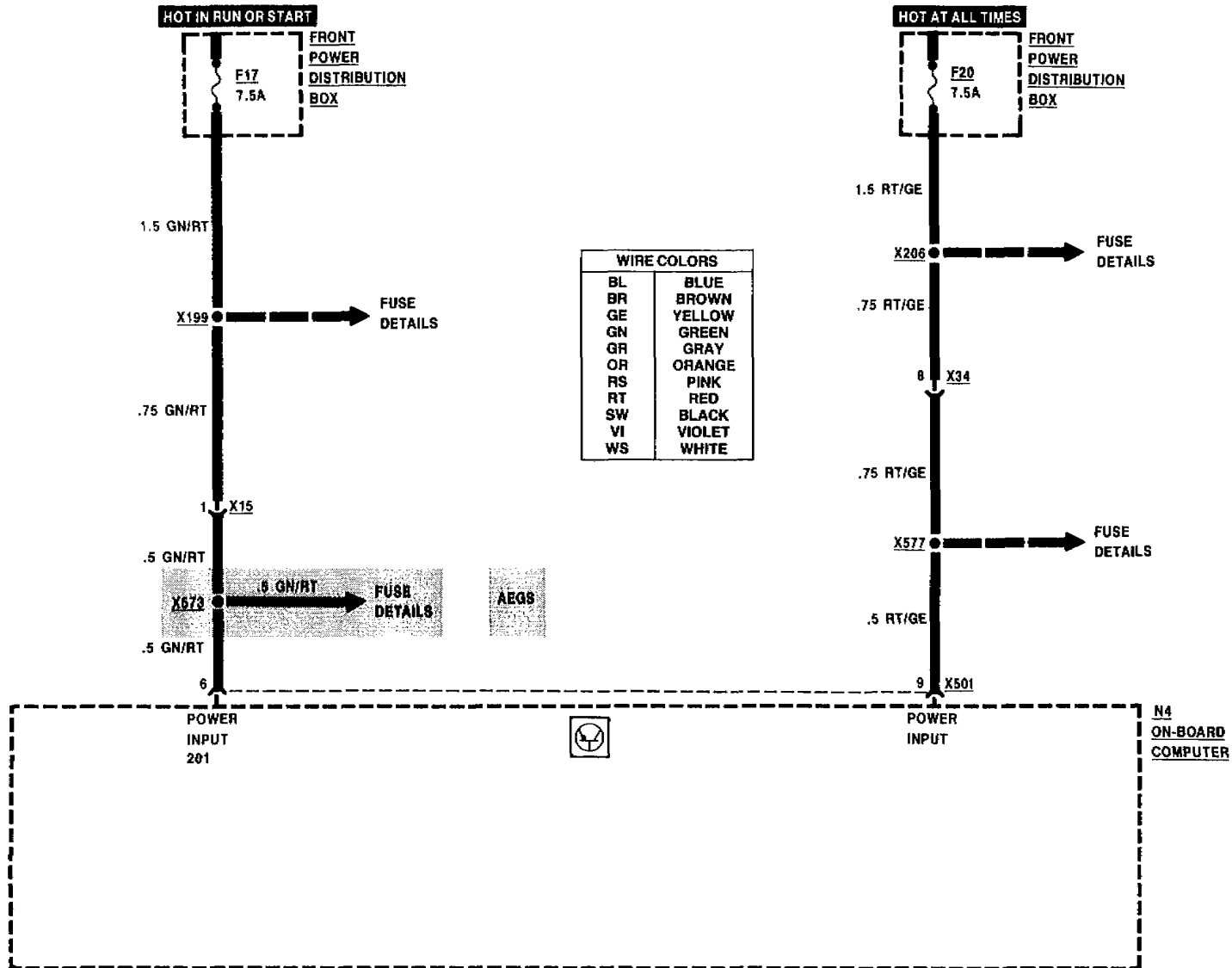

ON-BOARD COMPUTER

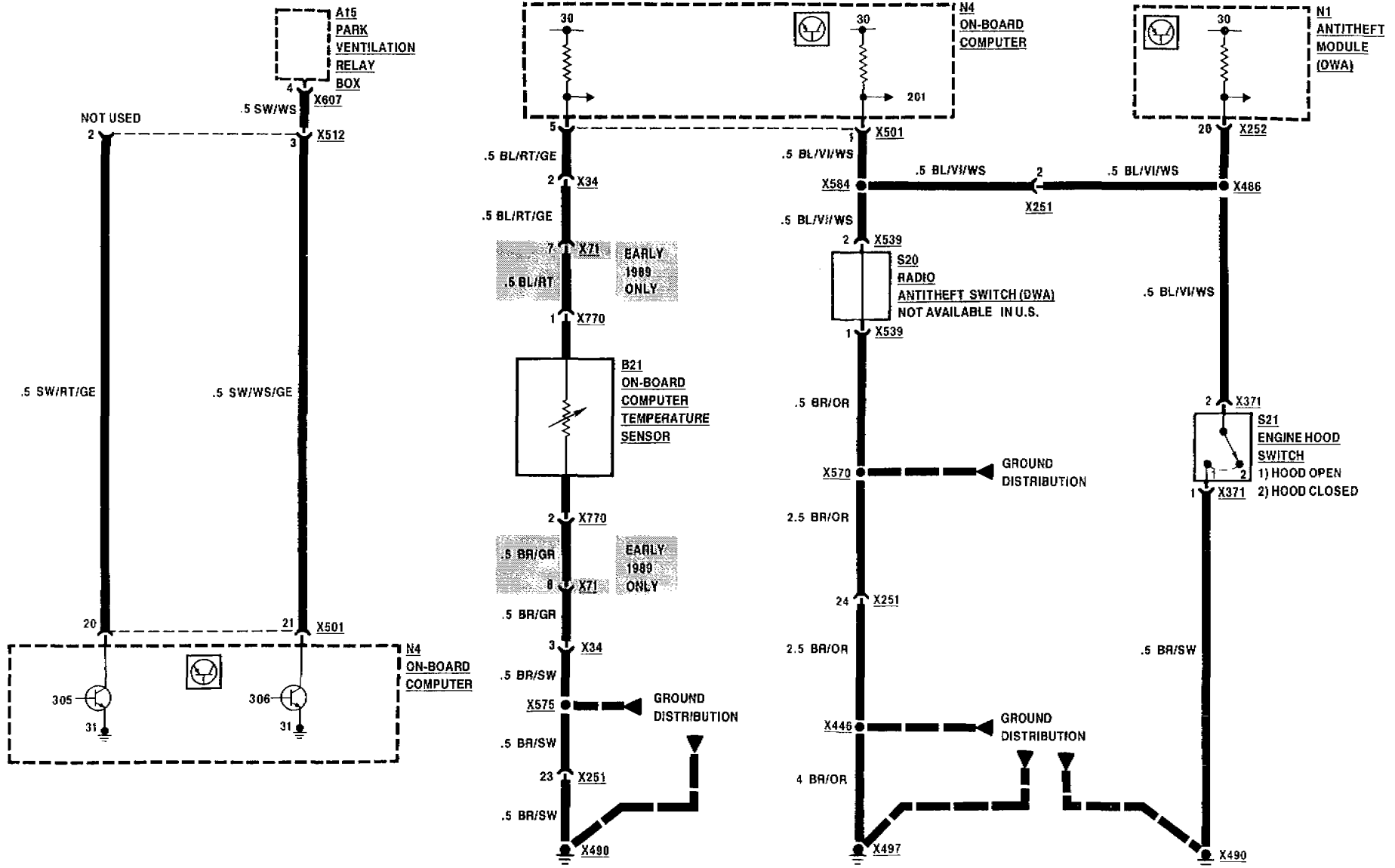



ON-BOARD COMPUTER ANTITHEFT HORN

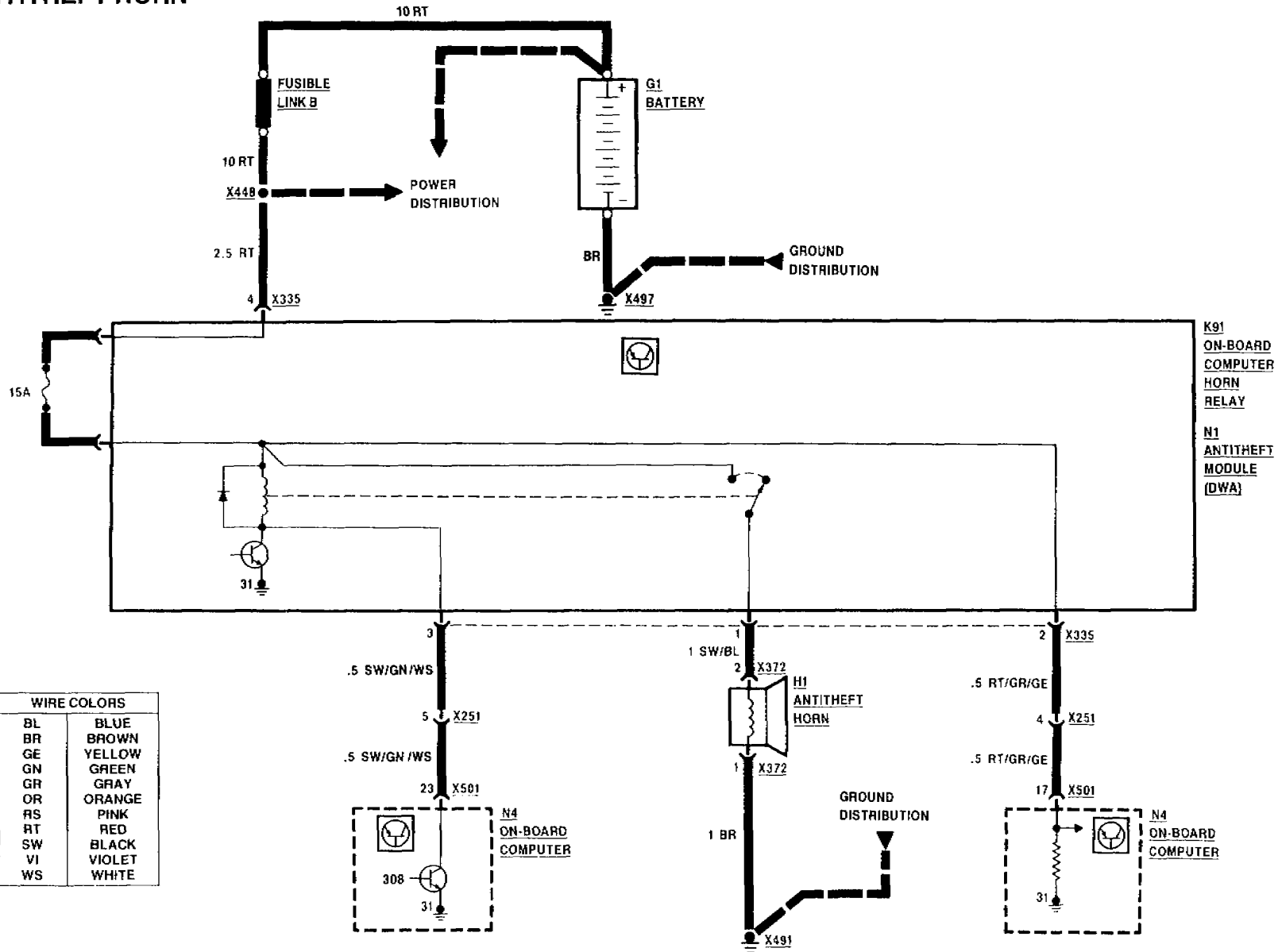



ON-BOARD COMPUTER

INJECTION SIGNAL, DRIVE AWAY PROTECTION, PROGRAMMING

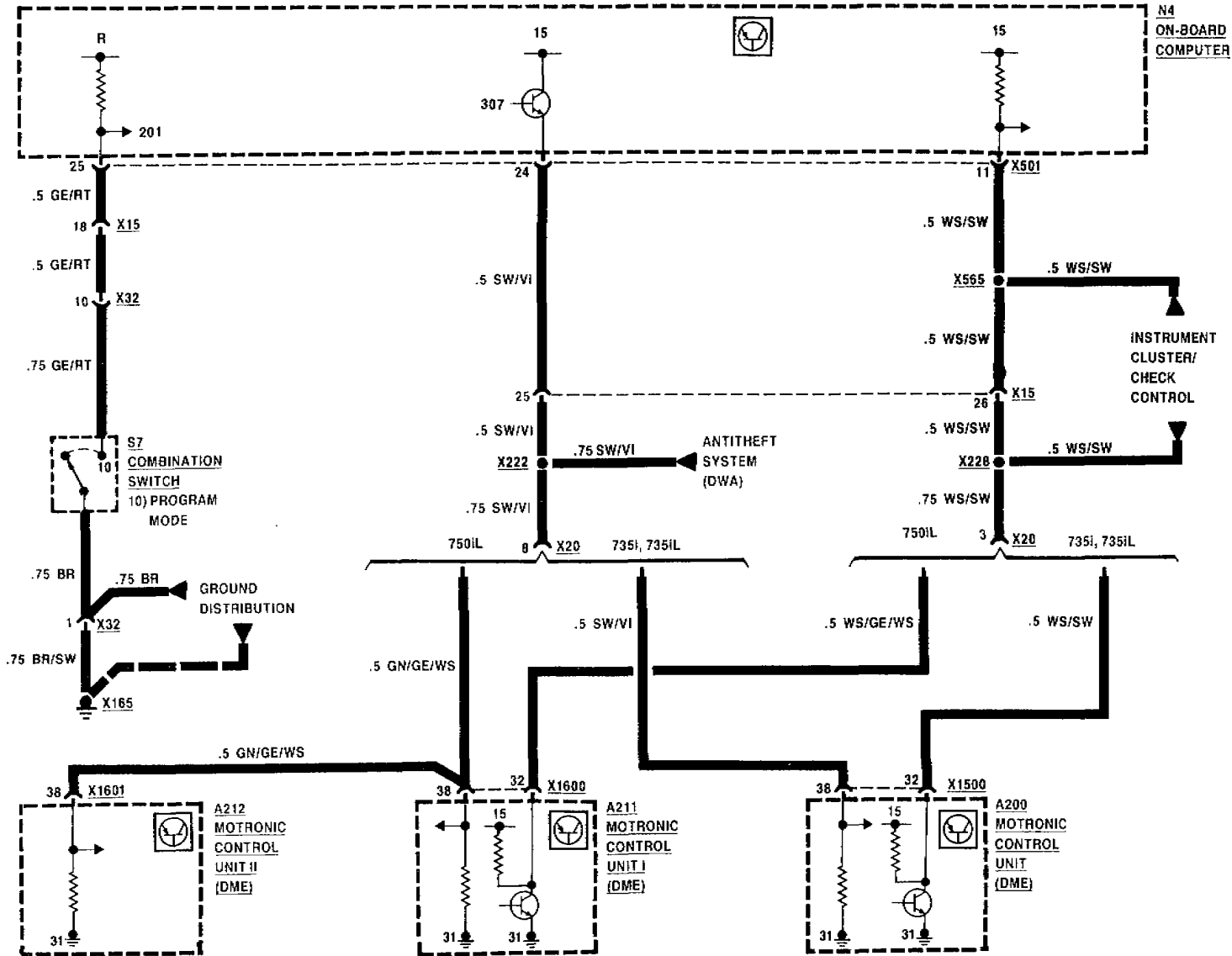

BMW
7 **ON-BOARD COMPUTER**
VEHICLE SPEED

11/89

6581-05

1989

WIRE COLORS	
BL	BLUE
BR	BROWN
GE	YELLOW
GN	GREEN
GR	GRAY
OR	ORANGE
RS	PINK
RT	RED
SW	BLACK
VI	VIOLET
WS	WHITE

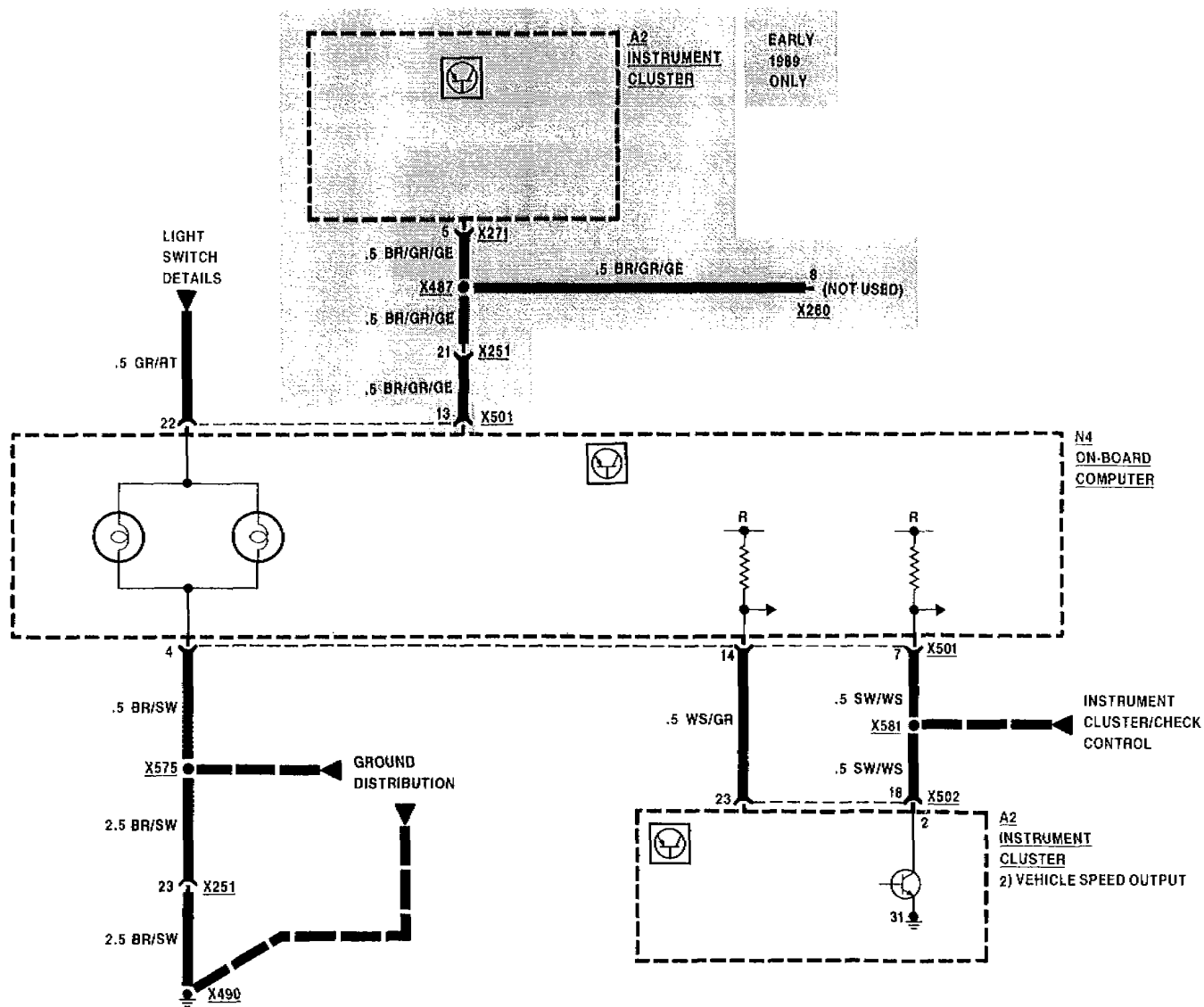



ON-BOARD COMPUTER

FUEL INFORMATION

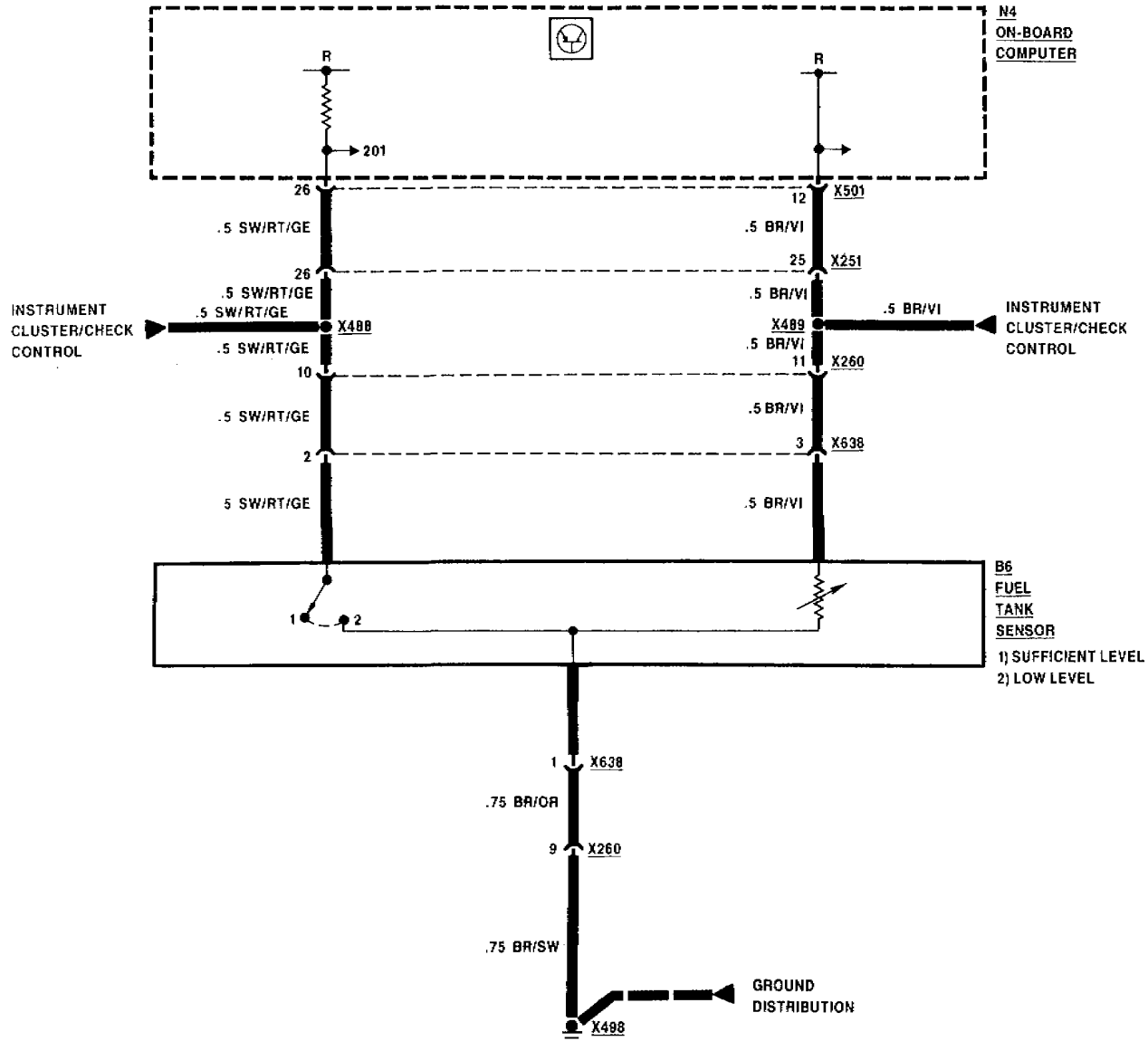

WIRE COLORS	
BL	BLUE
BR	BROWN
GE	YELLOW
GN	GREEN
GR	GRAY
OR	ORANGE
RS	PINK
RT	RED
SW	BLACK
VI	VIOLET
WS	WHITE



ON-BOARD COMPUTER CHIME MODULE

WIRE COLORS	
BL	BLUE
BR	BROWN
GE	YELLOW
GN	GREEN
GR	GRAY
OR	ORANGE
RS	PINK
RT	RED
SW	BLACK
VI	VIOLET
WS	WHITE

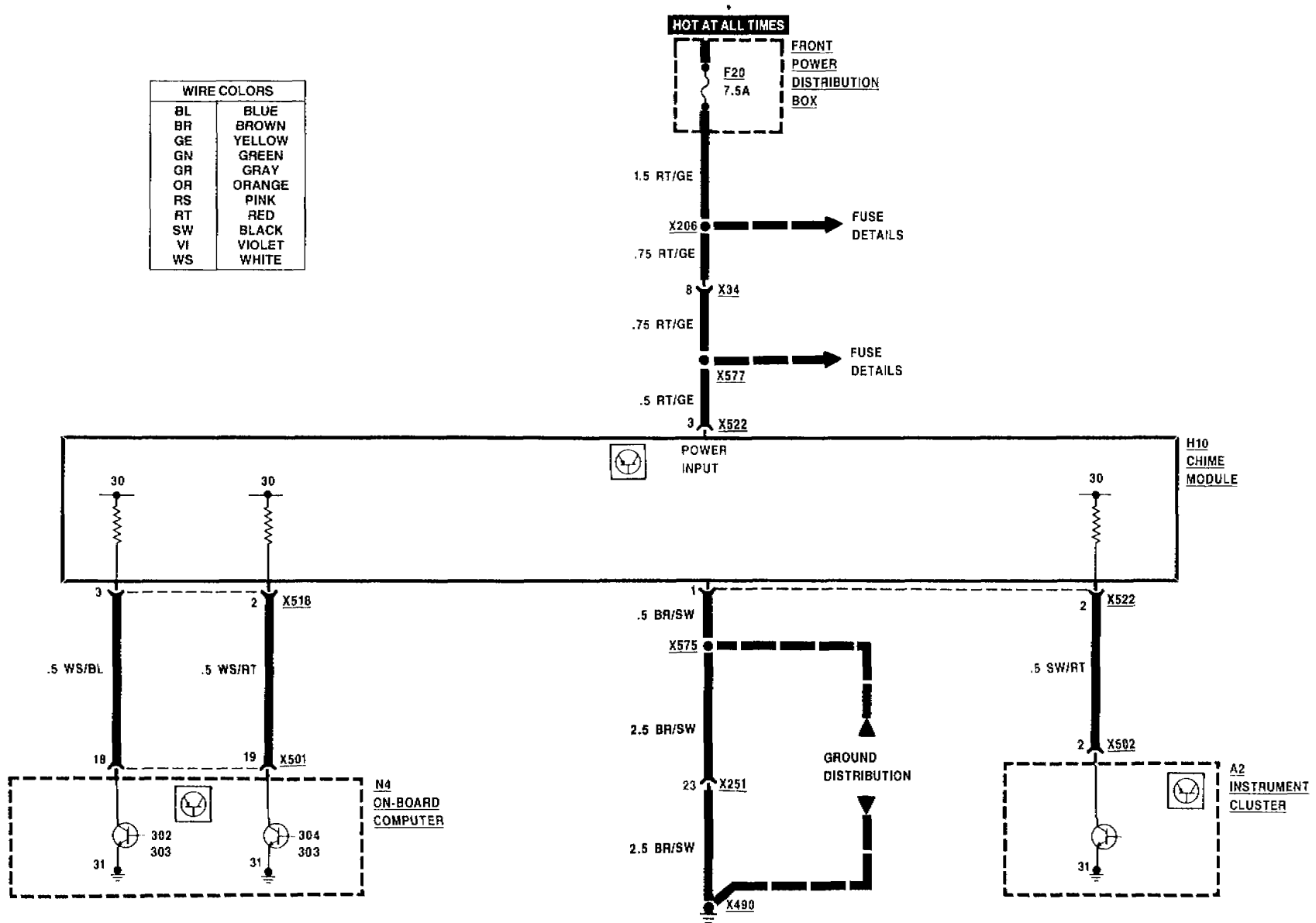



ON-BOARD COMPUTER DATA LINK

09/88

6581-08

1989

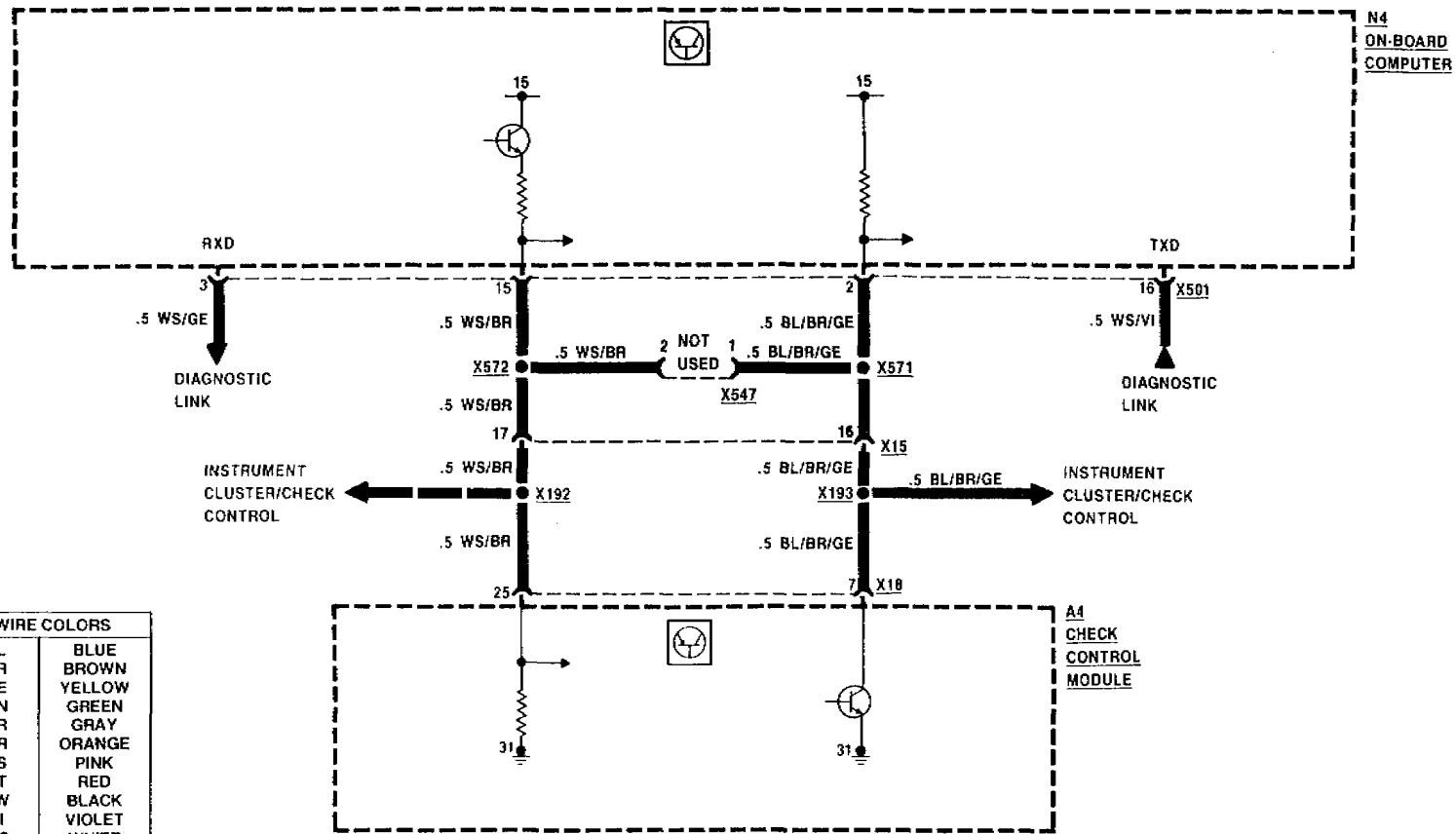

WIRE COLORS	
BL	BLUE
BR	BROWN
GE	YELLOW
GN	GREEN
GR	GRAY
OR	ORANGE
RS	PINK
RT	RED
SW	BLACK
VI	VIOLET
WS	WHITE



INFRARED LOCKING (IRS) POWER, GROUND, DATA LINK

735iL, 750iL

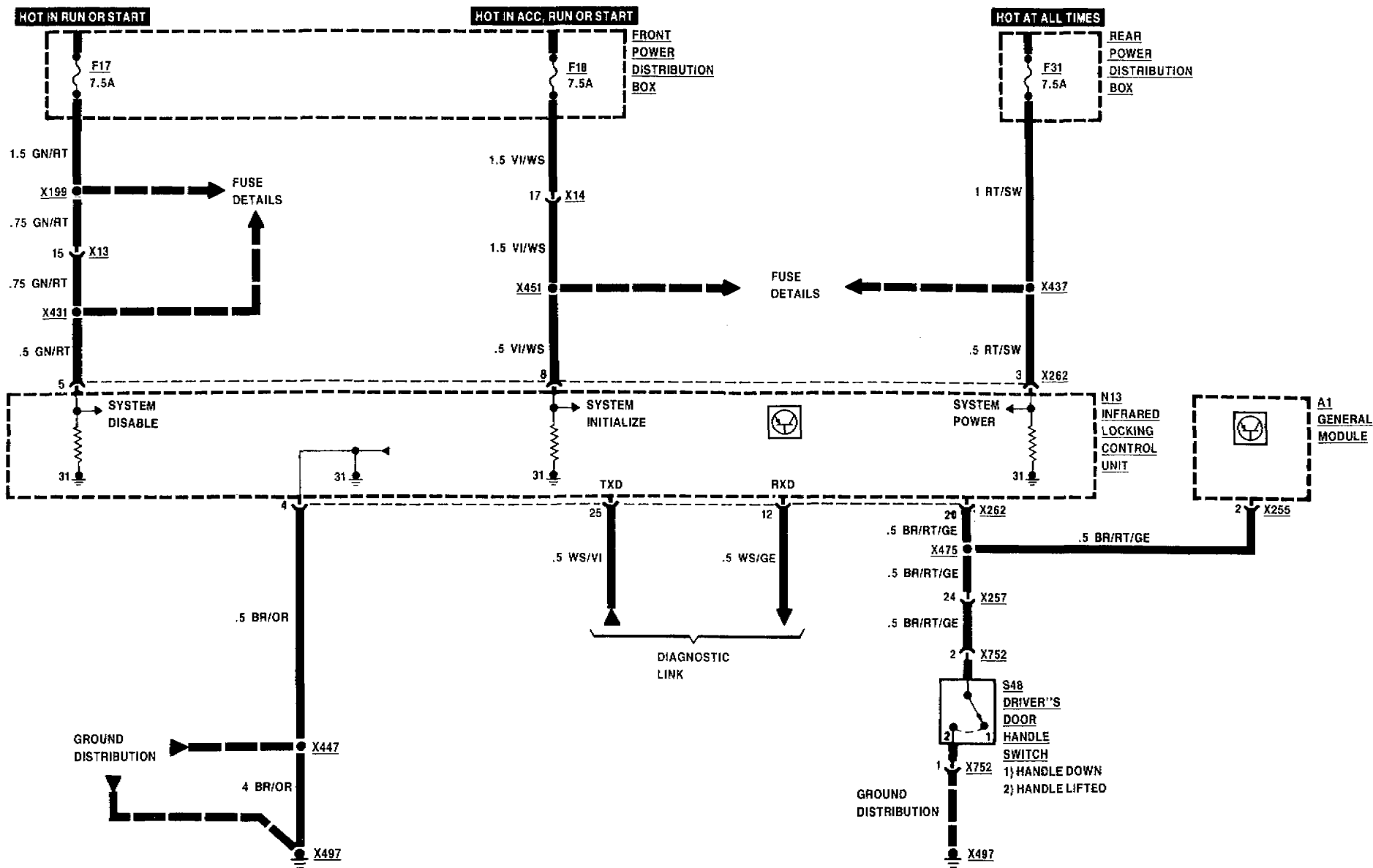



INFRARED LOCKING (IRS) INITIALIZE, RECEIVER CIRCUITS

735iL, 750iL

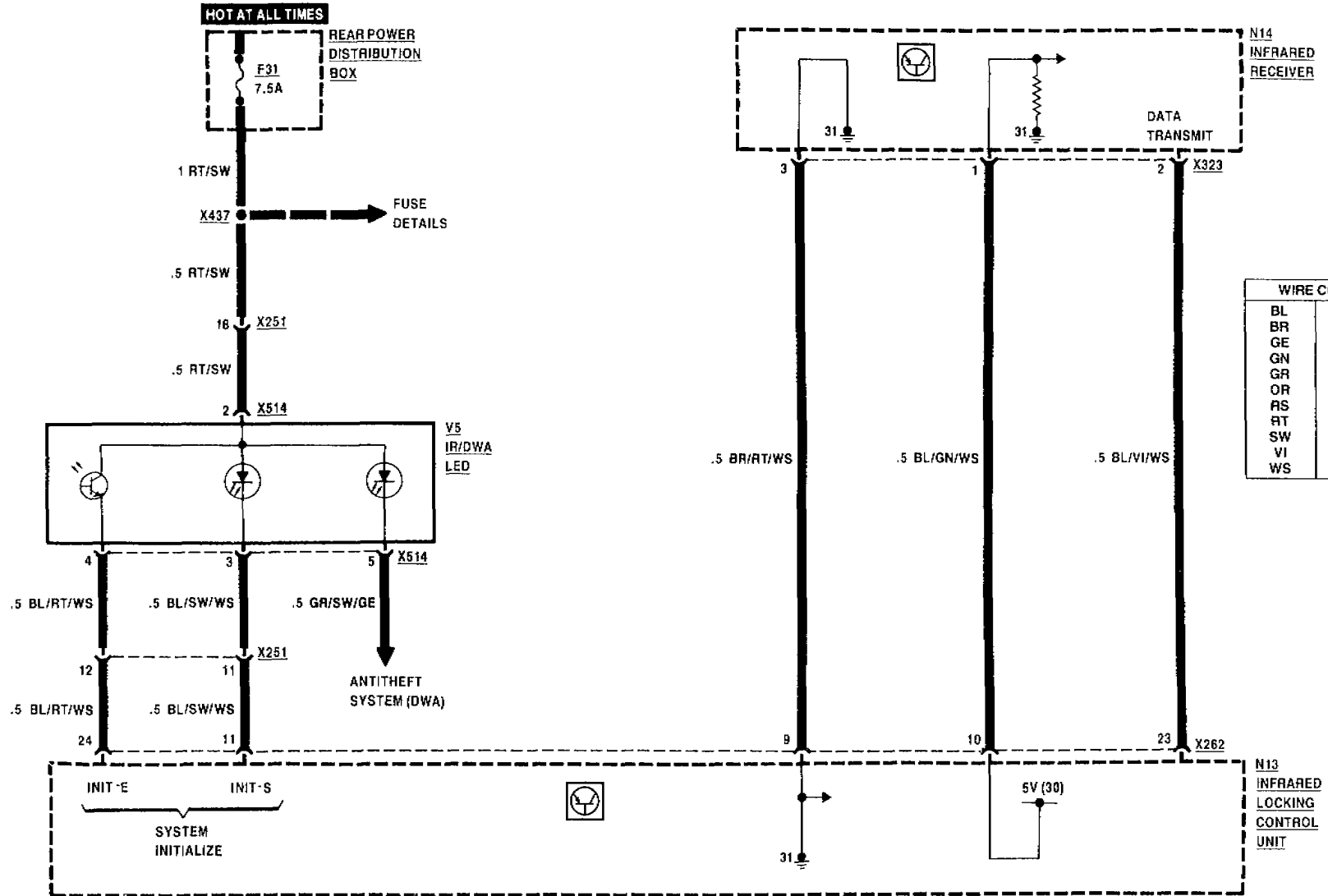



INFRARED LOCKING (IRS)

735iL, 750iL

LOCK, UNLOCK, ANTITHEFT CONTROL

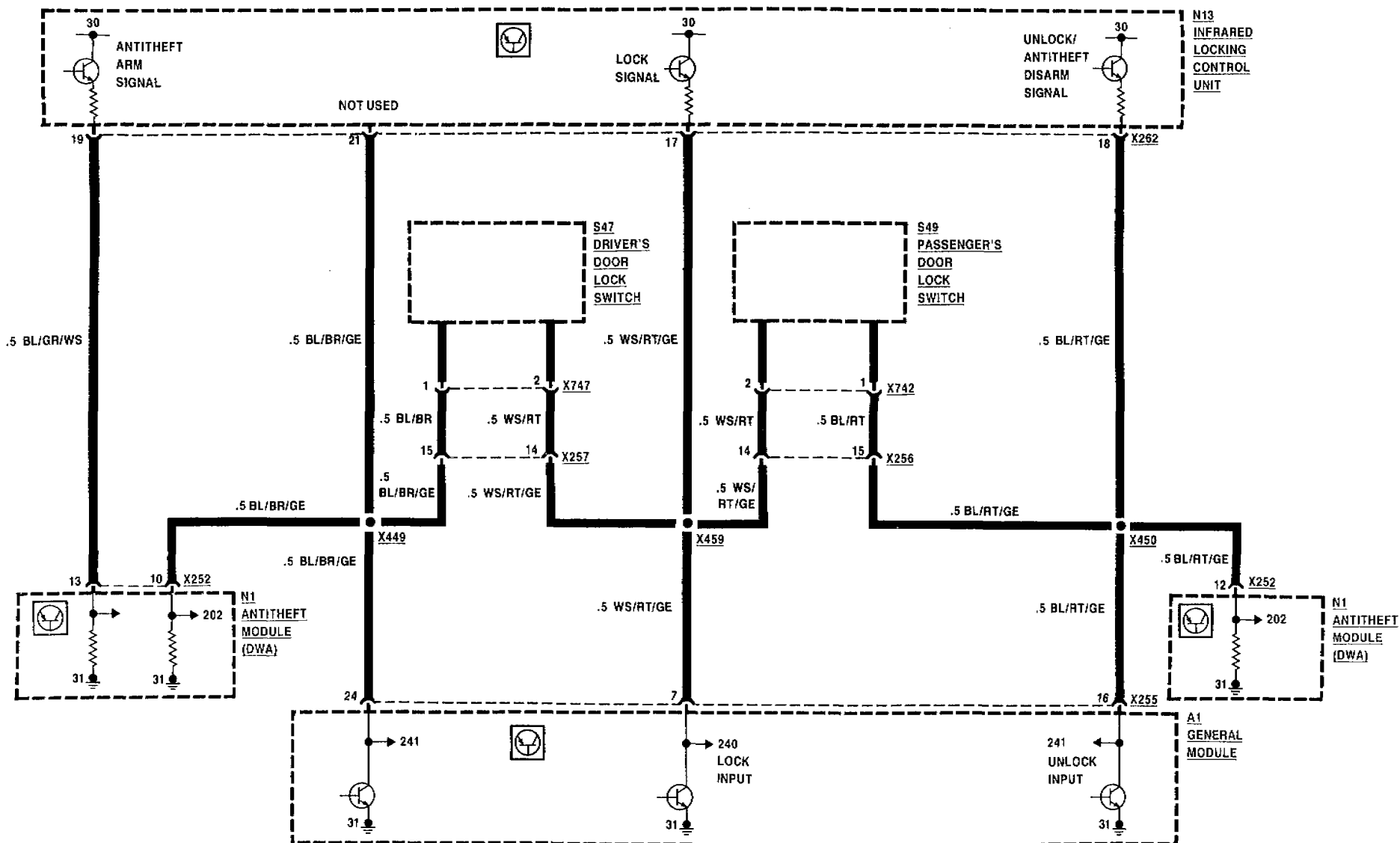



COMPONENT LOCATION CHART

COMPONENTS

Page-Figure

.....	Auxiliary Relay Box	LH side of engine compartment, ahead of shock tower	7100-04-01
.....	E-Box	RH side of engine, behind RH front shock tower	
.....	Front Power Distribution Box	LH rear of engine compartment	7100-09-01
.....	Fusible Link B	Below RH side of rear seat, right of Battery	7100-40-02
.....	Fusible Link A	Below RH side of rear seat, right of Battery	7100-40-02
.....	Rear Power Distribution Box	Below LH side of rear seat	7100-16-02
A1	General Module	Under LH side of rear seat, in Rear Power Distribution Box	7100-16-01
A3	Lamp Control Module	In Front Power Distribution Box	7100-04-03
A4	Check Control Module	In Front Power Distribution Box	7100-04-03
A5	Relay Module	Below LH side of rear seat, in Rear Power Distribution Box	7100-16-01
A6	Trailer Module (AHM)	In LH rear corner of luggage compartment, on rear panel	Not in US
A7	ABS Electronic Control Unit (750iL)	In E-Box, behind RH front shock tower	7100-34-01
A7	ABS Electronic Control Unit (735i/735iL)	In E-Box, behind RH front shock tower	7100-01-01
A8	Cruise Control Module (Tempomat)	In E-Box, behind RH front shock tower	7100-12-01
A9	Seat Belt Retractor Module	Next edition	Not in US
A10	Electronic Heater Control Unit	Between front footwells, ahead of HR plenum	7100-13-01
A11	Automatic Heating and Air Conditioning Control Unit (IHKA)	Between front footwells, ahead of IHKA plenum	7100-13-01
A12	Diagnostic Module (SRS)	Below LH side of dash, left of steering column	7100-23-01
A13	Rear Headrest Control Unit	On Rear Power Distribution Box	0660-01
A14	Park Heating/Ventilation Control Unit	Under RH side of rear seat, behind battery	Not in US
A15	Park Heating/Ventilation Relay Box	Behind RH side of dash, above glove box	7100-33-01
A17	Servotronic Control Unit	By driver's footrest, behind speaker	7100-26-01
A18	HIFI Amplifier	Behind luggage compartment LH trim panel, on brace	7100-00-02
A20	Booster/Amplifier	In upper RH corner of luggage compartment	7100-31-01
A21	Memory Seat/Mirrors Control Unit	Under driver's seat	7100-27-03
A26	Lock Sensor Control Unit	Behind kick panel, in driver's footwell	
A70	ABS/ASC Electronic Control Unit	In E-Box, behind RH front shock tower	Not in US
A80	EDC Electronic Control Unit	Under RH side of rear seat, near Battery	7100-17-03
A200	Motronic Control Unit (DME)	In E-Box, behind RH front shock tower	7100-12-01
A202	Electronic Throttle Control Unit	In E-Box, behind RH front shock tower	Not in US
A210	EML Electronic Control Unit	In E-Box, behind RH front shock tower	7100-34-01



COMPONENT LOCATION CHART

A211	Motronic Control Unit I (DME)	In E-Box, behind RH front shock tower	7100-34-01
A212	Motronic Control Unit II (DME)	In E-Box, behind RH front shock tower	7100-34-01
A300	Electronic Transmission Control Unit (AEGS)	Behind RH kick panel	7100-17-02
A301	Kick-Down Prevent Relay	Behind RH kick panel	7100-17-02
A902	Catalyst Temperature Switching Unit (JAPAN)	On Rear Power Distribution Box (see Section 0660)	Not in US
B1	Right Front Speed Sensor	Behind RH front wheel	7100-08-02
B2	Left Front Speed Sensor	Behind LH front wheel	7100-07-02
B3	Right Rear Speed Sensor	Behind RH rear wheel, on axle	7100-09-03
B4	Left Rear Speed Sensor	Behind LH rear wheel, on axle	7100-09-02
B5	Level Control Unit	Below car, left of differential	Not in US
B6	Fuel Tank Sensor	Below luggage compartment, thru RH access panel, right of spare tire	7100-00-01
B7	Low Pressure Switch	RH front of engine compartment, below washer reservoir	7100-30-01
B8	High Pressure Switch	RH front of engine compartment, below washer reservoir	7100-30-01
B9	Intermediate Pressure Switch	RH front of engine compartment, below washer reservoir	7100-30-01
B10	Vehicle Speed Sensor	Rear of car, on differential	7100-10-01
B11	Left Heat Exchanger Temperature Sensor	Below LH side of dash, in LH side of IHKA/HR plenum	
B12	Right Heat Exchanger Temperature Sensor	Below RH side of dash, in RH side of IHKA/HR plenum	7100-14-01
B13	Outside Temperature Sensor	Behind coolant expansion tank support panel, on right of M30 Blower Motor	
B14	Evaporator Temperature Sensor	Below LH side of dash, on lower LH side of IHKA/HR plenum	7100-14-03
B15	Electro-Hydraulic Converter (Servotronic)	Below LH front of car, behind LH front wheel	7100-30-02
B16	Left Front Brake Pad Sensor	Behind LH front wheel, on caliper	7100-07-02
B17	Right Rear Brake Pad Sensor	Behind RH rear wheel, on caliper	7100-09-03
B18	Brake Fluid Level Switch (735i/735iL)	LH rear of engine compartment, top of brake fluid reservoir	7100-04-02
B18	Brake Fluid Level Switch (750iL)	LH rear of engine compartment, top of brake fluid reservoir	7100-35-03
B19	Brake Pressure Regulating Switch (735i/735iL)	LH side of engine compartment, right of shock tower	7100-04-02
B19	Brake Pressure Regulating Switch (750iL)	LH side of engine compartment, right of shock tower	7100-34-02
B20	Brake Pressure Switch (735i/735iL)	LH side of engine compartment, right of shock tower	7100-04-02
B20	Brake Pressure Switch (750iL)	LH side of engine compartment, right of shock tower	7100-34-02
B21	On-Board Computer Temperature Sensor	Under front bumper, right side	7100-30-03



COMPONENT LOCATION CHART

B22	Wheel Camber Control Unit	Below car, above RH halfshaft	7100-26-03
B23	Catalyst Thermocouple Left	On Catalytic Converter	
B24	Catalyst Thermocouple Right	On Catalytic Converter	
B26	Left Footwell Temperature Sensor	Below LH side of dash, above kick panel	
B27	Right Footwell Temperature Sensor	Below RH side of dash, above kick panel	
B201	Cylinder Identification Sensor	RH front of engine, on distributor	7100-03-01
B202	Engine Speed/Reference Point Sensor	Front of engine, below distributor	7100-03-01
B203	Oxygen Sensor	In top of catalyst, near rear of transmission	7100-07-03
B204	Coolant Temperature Sensor	On coolant inlet, near valve cover	7100-38-03
B205	Oil Level Sensor	On bottom of oil pan	7100-07-01
B206	Oil Pressure Switch (735i/735iL)	Top rear of engine, rear of cylinder head	7100-02-03
B206	Oil Pressure Switch (750iL)	LH side of engine, near wheel well	7100-37-01
B207	Coolant Temperature Sender (735i/735iL)	On coolant inlet, near valve cover	7100-38-03
B207	Coolant Temperature Sender (750iL)	RH rear of engine, near E-Box	7100-35-02
B208	Air Flow Meter	Top center of engine, ahead of oil fill cap	7100-02-01
B209	Water Temperature Sensor (735i/735iL)	On coolant inlet, near valve cover	7100-38-03
B209	Water Temperature Sensor (750iL)	RH rear of engine, near E-Box	7100-35-02
B210	Temperature Switch	In E-Box, behind RH front shock tower	
B220	Cylinder Identification Sensor I	On spark plug wire #6, under LH distributor cover	
B221	Cylinder Identification Sensor II	On spark plug wire #12, under RH distributor cover	
B222	Engine Speed Sensor I	Lower front of engine	
B223	Engine Speed Sensor II	Lower front of engine	
B224	Engine Intake Air Temperature Sensor I (Cyl 1-6)	RH rear of engine, near E-Box	7100-35-02
B225	Engine Intake Air Temperature Sensor II (Cyl 7-12)	LH rear of engine compartment, right of Front Power Distribution Box	7100-34-03
B226	Air Mass Meter I (Cyl 1-6)	LH front of engine	7100-36-02
B227	Air Mass Meter II (Cyl 7-12)	RH front of engine	7100-36-01
B228	Water Temperature Sensor (DME)	RH rear of engine, near filter	7100-35-02
B301	Oxygen Sensor I	In top of catalyst	
B302	Oxygen Sensor II	In top of catalyst	
B900	Jumper Plug	In Front Power Distribution Box	7100-04-03
B901	Catalyst Thermocouple	Next edition	Not in US



COMPONENT LOCATION CHART

C100	Contact Ring	On steering wheel base, in front of airbag	
C900	Defogger Coupler	In RH "C"-pillar	
D100	Diagnostic Connector (750iL)	LH rear of engine compartment, ahead of shock tower	7100-34-03
D100	Diagnostic Connector (735i/735iL)	RH rear of engine compartment, ahead of shock tower	7100-01-03
E48	Door Lock Heater	In door, at key lock assembly	
E50	Park Heating Unit	RH side of engine compartment	Not in US
E51	Left Washer Jet Heater	Under cover, on engine hood	7100-27-02
E52	Right Washer Jet Heater	Under cover, on engine hood	7100-33-03
E55	Front Defogger	Lower part of front windshield	
E56	Driver's Seatback Heater	In back of driver's seat	
E57	Driver's Seat Heater	In driver's seat	
E58	Passenger's Seat Heater	In passenger's seat	
E59	Passenger's Seatback Heater	In back of passenger's seat	
E65	Left Rear Seatback Heater	In LH rear seatback	
E66	Left Rear Seat Heater	In LH rear seat	
E67	Right Rear Seat Heater	In RH rear seat	
E68	Right Rear Seatback Heater	In RH rear seatback	
F0	Fusible Link (80 Amp)	Below RH side of rear seat, near B+ terminal on Battery	7100-19-01
F53	Fuse (10 Amp)	In RH corner of luggage compartment	
F99	Fusible Link (50A)	Under RH side of rear seat, near B+ terminal on Battery	
G3	Auxiliary Battery	In RH corner of luggage compartment	Not in US
G5	Driver's Air Bag Generator	In center of steering wheel	
G6	Passenger's Air Bag Generator I	Next edition	
G7	Passenger's Air Bag Generator II	Next edition	
H1	Antitheft Horn (DWA)	Below RH fresh air cowl	
H2	Left Horn	Front of car, behind grille	7100-24-03
H3	Right Horn	Front of car, behind grille	7100-24-03
H10	Chime Module	Behind LH side of dash, mounted in hush panel	7100-25-03
H60	Audible Turn Signal Relay	Under RH side of steering column	7100-17-01
K1	Starter Relay	In Front Power Distribution Box	7100-04-03
K2	Horn Relay	In Front Power Distribution Box	7100-04-03
K3	Unloader Relay, KLR	In Front Power Distribution Box	7100-04-03



COMPONENT LOCATION CHART

K4	Blower Relay	In Front Power Distribution Box	7100-04-03
K5	Washer Pump Relay	In Front Power Distribution Box	7100-11-01
K7	Parking Light Monitor Relay	In Front Power Distribution Box	7100-11-01
K8	Front Defogger/Water Pump Relay	In Front Power Distribution Box	7100-11-01
K9	Unloader Relay, KL15	In Front Power Distribution Box	7100-11-01
K10	ABS Relay	In Front Power Distribution Box	7100-11-01
K11	Wiper Relay	Under LH side of rear seat, on Rear Power Distribution Box	7100-16-02
K12	Wiper Pressure Control Relay (ADV)	Under LH side of rear seat, on Rear Power Distribution Box	7100-16-02
K13	Rear Defogger Relay	Under LH side of rear seat, on Rear Power Distribution Box	7100-16-02
K14	Auxiliary Battery Relay	In RH corner of luggage compartment	Not in US
K15	Electric Power Protection Relay	Under LH side of rear seat, on Rear Power Distribution Box	7100-16-02
K16	Hazard Flasher Relay	In Front Power Distribution Box	7100-11-01
K17	Rear Seat Heating Relay	On Rear Power Distribution Box (see Section 0660)	
K19	Compressor Control Relay	By driver's footrest, behind speaker (IHKA)	7100-26-01
K21	Normal Speed Relay (735i/735iL)	LH side of engine compartment, in Relay Box, front of shock tower	7100-22-03
K21	Normal Speed Relay (750iL)	LH side of engine compartment, in Relay Box, front of shock tower	7100-34-02
K22	High Speed Relay (750iL)	LH side of engine compartment, in Relay Box, front of shock tower	7100-34-02
K22	High Speed Relay (735i/735iL)	LH side of engine compartment, in Relay Box, front of shock tower	7100-22-03
K27	Right Rear Seat Heating/Position Relay	On Rear Power Distribution Box (see Section 0660)	
K28	Right Rear Seat Heating/Position Relay	On Rear Power Distribution Box (see Section 0660)	
K31	Cigar Lighter Relay	In Front Power Distribution Box	
K33	Air Conditioning Motronic Relay (750iL)	LH side of engine compartment, in Relay Box, front of shock tower	7100-34-02
K33	Air Conditioning Motronic Relay (735i/735iL)	LH side of engine compartment, in Relay Box, front of shock tower	7100-22-03
K44	KSA-Relay	Under LH side of rear seat, on Rear Power Distribution Box	Not in US
K91	On-Board Computer Horn Relay	Under LH side of rear seat, ahead of Rear Power Distribution Box	7100-19-03



COMPONENT LOCATION CHART

K201	Fuel Pump Relay	In E-Box, behind RH front shock tower.	7100-01-01
K202	Main Relay	In E-Box, behind RH front shock tower.	7100-01-01
K210	Fuel Pump Relay I (Cyl 1-6)	In Auxiliary Relay Box, front of RH front shock tower	7100-24-01
K211	Fuel Pump Relay II (Cyl 7-12)	In Auxiliary Relay Box, front of RH front shock tower	7100-24-01
K212	Main Relay I (Cyl 1-6)	In Auxiliary Relay Box, front of RH front shock tower	7100-24-01
K213	Main Relay II (Cyl 7-12)	In Auxiliary Relay Box, front of RH front shock tower	7100-24-01
K214	Oxygen Sensor Relay	In Auxiliary Relay Box, front of RH front shock tower	7100-24-01
K903	Cigar Lighter Relay Jumper	In Front Power Distribution Box	Not in US
M1	Starter (735i/735iL)	Lower LH side of engine, below intake manifold.	7100-08-01
M1	Starter (750iL)	Lower RH side of engine, below intake manifold	
M2	Fuel Pump	Below luggage compartment, right of spare tire	7100-00-01
M3	Wiper Motor	Behind LH fresh air cowl	7100-05-01
M4	Washer Pump	RH front of engine compartment, on washer fluid reservoir	7100-02-02
M5	Intensive Wash Pump	RH front of engine compartment, on washer fluid reservoir	7100-02-02
M6	Wiper Pressure Control Motor (ADV)	Below LH side of fresh air cowl	7100-05-03
M7	Headlight Washer Pump (735iL)	LH front of engine compartment, on washer fluid reservoir.	7100-03-03
M7	Headlight Washer Pump (750iL)	RH front of engine compartment, on washer fluid reservoir	
M8	Fog Light Washer Pump (735iL)	LH front of engine compartment, on washer fluid reservoir.	7100-03-03
M8	Fog Light Washer Pump (750iL)	RH front of engine compartment, on washer fluid reservoir	
M9	Auxiliary Fan Motor	Center front of engine compartment, behind bumper	7100-03-02
M11	Fuel Pump II	Below luggage compartment, right of spare tire	
M12	Driver's Door Lock Motor	Top rear of door	7100-06-02
M13	Passenger's Door Lock Motor	Top rear of door	7100-06-02
M14	Right Rear Door Lock Motor	Top rear of door	7100-31-03
M15	Left Rear Door Lock Motor	Top rear of door	7100-31-03
M16	Gas Filler Lock Motor	In luggage compartment, behind RH wheel well.	7100-01-02
M17	Trunk Lock Motor	In luggage compartment, right of lid lock assembly	7100-00-03
M20	Left Rear Window Motor	Lower front of door	7100-31-03
M21	Driver's Window Motor	Lower front of door	7100-06-02
M22	Right Rear Window Motor	Lower front of door	7100-31-03
M23	Passenger's Window Motor	Lower front of door	7100-06-02
M24	Sunroof Motor	In center of windshield header, near rear view mirror	7100-10-03



COMPONENT LOCATION CHART

M25	Cruise Control Actuator (Tempomat)	Left center of engine compartment, ahead of shock tower	7100-04-01
M26	Left Rear Seat Movement Motor	Underside of RH rear seat	7100-32-03
M29	Right Rear Seat Movement Motor	Underside of RH rear seat	7100-32-03
M30	Blower Motor	Below center of cowl, behind coolant expansion tank support panel	
M31	Left Footwell Flap Motor	Below LH side of dash, on LH side of IHKA/HR plenum	7100-13-03
M32	Right Footwell Flap Motor	Below RH side of dash, on RH side of IHKA/HR plenum	7100-14-01
M33	Right Ventilation Flap Motor	Below RH side of dash, on RH side of IHKA/HR plenum	7100-14-01
M34	Right Mixing Flap Motor	In center of dash, right of radio	7100-13-02
M35	Defroster Flap Motor	Below LH side of dash, on lower left side of IHKA/HR plenum	7100-14-02
M36	Fresh Air Flap Motor	Below LH side of dash, on left side of IHKA/HR plenum	7100-14-02
M37	Water Pump	LH rear of engine compartment, on engine bulkhead	7100-09-01
M38	Left Ventilation Flap Motor	In LH side of dash, on left side of IHKA plenum	7100-15-01
M39	Left Mixing Flap Motor	In center of dash, left of radio	7100-13-03
M40	Air Circulation Flap Motor	Below LH side of dash, on left side of IHKA plenum	7100-14-02
M41	Rear Compartment Flap Motor	In front of console, on lower rear of IHKA/HR plenum	7100-15-01
M49	Driver's Seat Belt Actuator		Not in US
M50	Driver's Seat Cushion Tilt Motor	Under driver's seat	7100-28-02
M51	Driver's Seat Movement Motor	Under driver's seat	7100-27-03
M52	Driver's Seat Height Motor	Under driver's seat	7100-28-02
M53	Driver's Seatback Recliner Motor	Under driver's seat	7100-28-02
M54	Driver's Headrest Motor	In top RH corner of driver's seatback	7100-31-02
M55	Driver's Seat Lumbar Support Motor	In driver's seatback	
M56	Passenger's Seat Lumbar Support Motor	In passenger's seatback	
M57	Passenger's Seat Headrest Motor	In top RH corner of passenger's seatback	7100-31-02
M58	Passenger's Seatback Recliner Motor	Under passenger's seat	7100-28-03
M59	Passenger's Seat Height Motor	Under passenger's seat	7100-28-03
M60	Passenger's Seat Movement Motor	Under passenger's seat	7100-28-03
M61	Passenger's Seat Cushion Tilt Motor	Under passenger's seat	7100-28-03
M62	Passenger's Seat Belt Motor		Not in US
M200	Throttle Position Motor	Top of engine, on throttle body	Not in US



COMPONENT LOCATION CHART

M201	E-Box Fan	In E-Box, below modules	
M202	Throttle Position Meter I (Cyl 1-6)	LH front side of engine compartment	7100-36-02
M203	Throttle Position Module II (Cyl 7-12)	RH front of engine compartment	7100-36-03
N1	Antitheft Module (DWA)	Under LH side of rear seat, ahead of Rear Power Distribution Box	7100-19-03
N2	Final Stage Unit	In left side of RH footwell, ahead of IHKA/HR plenum	7100-13-01
N4	On-Board Computer	Center of dash, right of radio	
N6	Headlight/Front Fog Light Module (SRA) (735i/735iL)	LH side of engine compartment, in Relay Box	7100-22-03
N6	Headlight/Front Fog Light Module (SRA) (750iL)	LH side of engine compartment, in Relay Box	7100-34-02
N8	Antenna Amplifier	In LH C pillar	7100-21-03
N13	Infra-Red Locking Control Unit	Below LH side of rear seat	7100-16-01
N14	Infra-Red Receiver	In center of windshield header, near rear view mirror	Not in US
N17	Crash Control Unit	In Front Power Distribution Box	7100-11-01
R1	Temperature Distribution Potentiometer	Above radio, in dash center IHKA/HR outlets	
R5	Headrest Potentiometer	On M54 Driver's Headrest Motor	
R6	Seat Height Potentiometer	On M52 Driver's Seat Height Motor	
R7	Seatback Potentiometer	On M53 Driver's Recliner Motor	
R8	Seat Cushion Rear Height Potentiometer	On M50 Driver's Seat Cushion Tilt Motor	
R9	Seat Cushion Movement Potentiometer	On M51 Driver's Seat Movement Motor	
R10	Pedal Position Sensor	Under LH side of dash, RH side of brake pedal	7100-06-01
S2	Ignition Switch	Top RH side of steering column	
S3	Automatic Transmission Range Switch	Under console, at base of shifter	7100-21-02
S4	Horn Switch	Top of steering column, in steering wheel	
S19	Underhood Light Switch	LH front of hood	7100-24-02
S20	Radio Antitheft Switch (DWA)	In dash, behind radio	7100-06-03
S21	Engine Hood Switch	RH rear of engine compartment, rear of shock tower	7100-12-01
S22	Battery Switch	Under RH side of rear seat, near battery	7100-19-01
S23	Trunk Lid Switch	Center of rear panel, below trunk latch	7100-00-03
S24	Rear Seat Switch	Under RH side of rear seat, right of battery	7100-19-01



COMPONENT LOCATION CHART

S27	Inertia Switch	Under center of rear seat, right of Rear Power Distribution Box.	7100-20-02
S29	Brake Light Switch	Under LH side of dash, on brake pedal	7100-06-01
S30	Brake Light Test Switch	Under LH side of dash, on brake pedal	7100-06-01
S31	Park Brake Switch	Under console, on rear of park brake lever.	7100-15-02
S32	Clutch Switch	Under LH side of dash, left of brake pedal	7100-06-01
S36	Temperature Switch	RH top of radiator.	7100-02-02
S39	Sunroof Position Switch	In center of windshield header, near rear view mirror	7100-10-03
S43	Driver's Window Limit Switch	Center front of door	7100-06-02
S44	Passenger's Window Limit Switch	Center front of door	7100-06-02
S45	Left Rear Window Limit Switch	Center front of door	7100-31-03
S46	Right Rear Window Limit Switch	Center front of door	7100-31-03
S47	Driver's Door Lock Switch	Behind driver's door lock	
S48	Driver's Door Handle Switch	Behind driver's door handle	
S49	Passenger's Door Lock Switch	Behind passenger's door lock	
S58	Driver's Seat Belt Switch	In driver's seat belt buckle	
S59	Passenger's Seat Belt Switch	In passenger's seat belt buckle	
S60	Hydraulic Switch	Below rear of car, right of differential	Not in US
S61	Trunk Lid Switch	In trunk lid, near trunk lock	
S63	Coolant Level Switch (750iL)	Top of coolant reservoir	7100-35-02
S63	Coolant Level Switch (735i/735iL)	Top of coolant reservoir	7100-02-01
S64	Washer Fluid Level Switch	RH side of washer fluid reservoir	7100-02-02
S65	Power Steering Fluid Level Switch (735i/735iL)	LH front of engine, on Power Steering Fluid Container	7100-04-01
S65	Power Steering Fluid Level Switch (750iL)	LH side of engine compartment, on Power Steering Fluid Container	7100-35-03
S70	Safety Switch	Ahead of LH shock tower	7100-11-02
S71	Left Front Crash Sensor	Ahead of LH shock tower	7100-11-02
S72	Right Front Crash Sensor	Ahead of RH shock tower	7100-11-03
S95	Hydraulic Switch		Not in US
S100	Rear Vent Flap Switch	In rear of console, on rear vent flap	7100-20-03
S200	Throttle Switch	Top of engine, on throttle body	7100-02-01
S302	Manual Transmission Back-Up Switch	Top RH side of transmission	



COMPONENT LOCATION CHART

T200	Ignition Coil	RH side of engine compartment, at strut tower	7100-01-03
T201	Ignition Coil I (Cyl 1-6)	RH front of engine compartment	7100-36-01
T202	Ignition Coil II (Cyl 7-12)	LH front of engine compartment	7100-36-02
V4	Driver's Day Light Coding Diode	In front of dash, near light switch	
Y1	ABS Hydraulic Unit (735i/735iL)	LH center of engine compartment, near shock tower	7100-04-02
Y1	ABS Hydraulic Unit (750iL)	LH front of engine compartment, behind headlight	7100-37-02
Y2	Compressor Clutch (IHKA)	RH front of engine	7100-03-01
Y3	Compressor	RH front of engine	
Y4	Water Valve Assembly	LH rear of engine compartment, on engine bulkhead	7100-09-01
Y7	Park Heating Metering Pump	Below rear of car, near RH rear wheel	Not in US
Y8	Hydraulic Height Level Control System	In rear of car, in spare tire housing	Not in US
Y11	Solenoid Valve 1	On LH side of engine, near oil filter	7100-32-02
Y12	Solenoid Valve 2	On LH side of engine, near oil filter	7100-32-02
Y82	EDC Right Front Shock Absorber	Top of RH front shock tower	7100-37-03
Y201	Fuel Injector 1	Top of engine, near B207 Coolant Temperature Sender	
Y202	Fuel Injector 2	Top of engine, on intake manifold	
Y203	Fuel Injector 3	Top of engine, on intake manifold	
Y204	Fuel Injector 4	Top of engine, on intake manifold	
Y205	Fuel Injector 5	Top of engine, on intake manifold	
Y206	Fuel Injector 6	Top of engine, on intake manifold	
Y207	Fuel Injector 7	Top of engine, on intake manifold	
Y208	Fuel Injector 8	Top of engine, on intake manifold	
Y209	Fuel Injector 9	Top of engine, on intake manifold	
Y210	Fuel Injector 10	Top of engine, on intake manifold	
Y211	Fuel Injector 11	Top of engine, on intake manifold	
Y212	Fuel Injector 12	Top of engine, on intake manifold	
Y213	Evaporative Purge Valve	LH side of engine, right of oil filter	7100-23-03
Y214	Idle Speed Actuator	On center rear of throttle body	7100-02-01
Y221	Evaporative Purge Valve I (Cyl 1-6)	LH front of engine compartment	
Y222	Evaporative Purge Valve II (Cyl 7-12)	RH front of engine compartment	7100-36-03
Y300	Transmission	LH rear side of transmission	7100-07-03
X1.0	Junction Post	Behind LH side of dash	7100-41-01



COMPONENT LOCATION CHART

X1.1	Junction Post	LH rear corner of engine compartment.	7100-40-03
X1.2	Junction Post	LH rear corner of engine compartment.	7100-40-03
X13	Connector (30 pins)	Below left side of dash, above footrest	7100-08-03
X14	Connector (30 pins)	Below left side of dash, above footrest	7100-08-03
X15	Connector (30 pins)	Below left side of dash, near hood release lever.	7100-23-01
X16	Connector (26 pins)	On A2 Instrument Cluster.	7100-22-01
X17	Connector (6 pins)	On A2 Instrument Cluster.	7100-22-01
X18	Connector (26 pins)	On A4 Check Control Module (Blue)	
X19	Connector (26 pins)	On A4 Check Control Module (Green)	
X20	Connector (20 pins) (750iL)	LH rear of engine compartment, near shock tower	7100-34-03
X20	Connector (20 pins) (735i/735iL)	LH rear of engine compartment, near shock tower	7100-09-01
X21	Connector (20 pins) (735i/735iL)	LH rear of engine compartment, near shock tower	7100-09-01
X21	Connector (20 pins) (750iL)	LH rear of engine compartment, near shock tower	7100-34-03
X32	Connector (12 pins)	Below LH side of dash, LH side of steering column	7100-26-02
X33	Connector (12 pins)	Below LH side of dash, LH side of steering column	7100-26-02
X34	Connector (21 pins)	Below LH side of dash, near hood release lever.	7100-23-01
X35	Connector (21 pins)	Below LH side of dash, near hood release lever.	7100-23-01
X36	Connector (10 pins)	Below LH side of dash, near hood release lever.	7100-23-01
X37	Connector (10 pins)	Below LH side of dash, near hood release lever.	7100-23-01
X65	Connector (8 pins)	In Front Power Distribution Box (see Section 0660)	
X69	Connector (8 pins)	In E-Box, behind RH front shock tower	
X71	Connector (8 pins)	Behind LH fog light.	7100-25-01
X72	Connector (8 pins)	Below LH side of dash, LH side of steering column	7100-26-02
X73	Connector (10 pins)	Under dash, right of steering column	
X74	Connector (8 pins)	Under LH side of dash, above footrest	7100-08-03
X75	Connector (6 pins)	Under LH side of dash, above footrest	7100-08-03
X79	Connector (4 pins)	In E-Box, behind RH front shock tower	
X82	Connector (3 pins)	RH front of engine compartment, on radiator housing	7100-36-01
X83	Connector (3 pins)	By driver's footrest, behind speaker.	7100-26-01
X84	Connector (3 pins)	By driver's footrest, behind speaker.	7100-26-01
X88	Connector (3 pins)	On left of steering column	
X95	Connector (3 pins)	RH front of engine compartment	7100-39-01



COMPONENT LOCATION CHART

X101	Connector (2 pins)	In watertight compartment, behind RH front shock tower	Not in US
X113	Connector (2 pins)	RH rear of engine compartment, near base of shock tower	7100-18-01
X114	Connector (2 pins)	LH rear of engine compartment, bottom of shock tower	7100-23-02
X115	Connector (2 pins)	Ahead of LH shock tower, inside safety switch	
X118	Connector (2 pins)	On LH front wheel, above brake caliper	7100-07-02
X122	Connector (2 pins)	LH rear of engine compartment, on engine bulkhead	7100-09-01
X142	Connector (2 pins)	Below LH side of rear seat, behind Rear Power Distribution Box	7100-16-02
X143	Connector (2 pins)	Below RH side of rear seat, behind Battery	7100-16-03
X162	Connector (1 pin)	On E55 Front Defogger	
X163	Connector (1 pin)	RH front of engine compartment, by washer fluid reservoir	Not in US
X165	Ground	Below LH side of dash, left of steering column	7100-32-01
X166	Ground (735i/735iL)	LH front of engine compartment, ahead of wheel well	7100-05-02
X166	Ground (750iL)	LH front of engine compartment, ahead of wheel well	7100-38-01
X167	Ground (750iL)	LH front of engine compartment, ahead of wheel well	7100-38-01
X167	Ground (735i/735iL)	LH front of engine compartment, ahead of wheel well	7100-05-02
X170	Ground	LH side of engine compartment, on Y1 ABS Hydraulic Unit	7100-23-02
X172	Ground (750iL)	LH front of engine compartment	
X172	Ground (735i/735iL)	LH front of engine compartment	7100-05-02
X173	Ground	RH front of engine compartment, ahead of wheel well	7100-38-02
X251	Connector (30 pins)	Below left side of dash, near hood release lever	7100-23-01
X252	Connector (26 pins)	On N1 Antitheft Module (DWA)	
X253	Connector (26 pins)	On A1 General Module (Green)	
X254	Connector (26 pins)	On A1 General Module (White)	
X255	Connector (26 pins)	On A1 General Module (Yellow)	
X256	Connector (26 pins)	Ahead of RH front door, in wire grommet	7100-12-03
X257	Connector (26 pins)	Ahead of LH front door, in wire grommet	7100-12-03
X258	Connector (20 pins)	On A5 Relay Module (White)	
X259	Connector (20 pins)	On A5 Relay Module (Black)	
X260	Connector (21 pins)	Below RH side of rear seat, near battery	7100-33-02
X271	Connector (12 pins)	On A2 Instrument Cluster	7100-22-01



COMPONENT LOCATION CHART

X272	Connector (12 pins)	Below LH side of rear seat, near Rear Power Distribution Box.	7100-16-01
X273	Connector (12 pins)	Ahead of LH rear door, in wire grommet.	7100-12-02
X274	Connector (12 pins)	Ahead of RH rear door, in wire grommet	7100-12-02
X275	Connector (12 pins)	Below driver's seat, under carpet.	7100-29-02
X277	Connector (10 pins)	Ahead of LH rear door, in wire grommet.	7100-12-02
X278	Connector (10 pins)	Ahead of RH rear door, in wire grommet	7100-12-02
X279	Connector (12 pins)	Below passenger's seat	7100-29-01
X295	Connector (8 pins)	Below LH side of dash	7100-26-02
X298	Connector (8 pins)	Behind luggage compartment trim panel, below LH lid hinge	7100-00-02
X316	Connector (6 pins)	On S40 Front Console Window Switch Assembly (White)MC	
X317	Connector (6 pins)	On S40 Front Console Window Switch Assembly (Black)	
X318	Connector (6 pins)	In luggage compartment, behind RH light assembly	Not in US
X319	Connector (6 pins)	In luggage compartment, behind LH light assembly	Not in US
X321	Connector (6 pins)	Below LH side of dash, left of steering column.	Not in US
X322	Connector (6 pins)	Below LH side of rear seat, near Rear Power Distribution Box.	7100-16-01
X331	Connector (5 pins)	On N1 Antitheft Module (DWA)	
X332	Connector (5 pins)	On A1 General Module (Black)	
X335	Connector (4 pins)	On N1 Antitheft Module (DWA)	
X337	Connector (4 pins)	Below LH side of rear seat, near Rear Power Distribution Box.	7100-20-02
X379	Connector (2 pins)	On E10 Rear Defogger	
X380	Connector (2 pins)	On E10 Rear Defogger	
X390	Connector (2 pins)	RH side of passenger's footwell, behind speaker panel	7100-17-02
X391	Connector (2 pins)	Below rear of console.	7100-15-02
X393	Connector (2 pins)	In LH rear corner of luggage compartment.	Not in US
X399	Connector (2 pins)	In LH rear corner of luggage compartment.	Not in US
X400	Connector (3 pins)	Behind rear seat back, left of RH wheel well	7100-18-03
X403	Connector (2 pins)	LH side of driver's footwell	7100-41-03
X419	Connector (1 pin)	Below LH side of rear seat, near Rear Power Distribution Box	



COMPONENT LOCATION CHART

X420	Connector (1 pin)	Below LH side of rear seat, near Rear Power Distribution Box	
X421	Connector (1 pin)	On E55 Front Defogger	
X490	Ground	Below LH side of dash, left of steering column	7100-32-01
X491	Ground	Below LH side of dash, left of steering column	7100-32-01
X492	Ground	Below LH side of rear seat, near Rear Power Distribution Box	7100-20-01
X493	Ground	Below LH side of rear seat, near Rear Power Distribution Box	7100-20-01
X494	Ground	Under RH side of rear seat, right of Battery	7100-19-02
X495	Ground	Under RH side of rear seat, right of battery	Not in US
X496	Ground	Under RH side of rear seat, right of battery	Not in US
X497	Ground	Under RH side of rear seat, right of battery	7100-19-02
X497	Ground (Battery)	Ahead of RH side of rear seat, under carpet	7100-19-01
X498	Ground	Under RH side of rear seat, right of Battery	7100-19-02
X502	Connector (26 pins)	On A2 Instrument Cluster	7100-22-01
X506	Connector (12 pins)	Below center console, front of shifter	7100-21-02
X512	Connector (8 pins)	Behind glove box	7100-15-03
X515	Connector (6 pins)	Below LH side of dash, left of steering column	Not in US
X518	Connector (4 pins)	On H10 Chime Module (Black)	7100-25-03
X519	Connector (4 pins)	Below RH side of dash, at kick panel	7100-41-02
X520	Connector (3 pins)	Under LH side of console, near shifter	7100-21-02
X522	Connector (3 pins)	On H10 Chime Module (White)	7100-25-03
X528	Connector (8 pins)	Below LH side of dash, left of steering column	7100-42-01
X533	Connector (2 pins)	On N9 Radio	
X534	Connector (2 pins)	On N9 Radio	
X535	Connector (2 pins)	On N9 Radio	
X536	Connector (2 pins)	On N9 Radio	
X542	Connector (2 pins)	In LH side of glove box	
X545	Connector (2 pins)	On N9 Radio	
X546	Connector (2 pins)	In center of console, LH side of manual gear selector	7100-27-01



COMPONENT LOCATION CHART

X551	Connector (1 pin)	On N9 Radio	
X553	Connector (1 pin)	On N9 Radio	
X601	Connector (26 pins)	On A21 Memory Seats/Mirrors Control Unit (Yellow)	7100-28-01
X602	Connector (26 pins)	On A21 Memory Seat/Mirrors Control Unit (White)	7100-27-03
X605	Connector (12 pins)	On A18 HIFI Amplifier (Black)	
X606	Connector (12 pins)	On A18 HIFI Amplifier (White)	
X608	Connector (11 pins)	On E50 Park Heating Unit (Black)	
X610	Connector (26 pins)	On A10 (HR) Unit or A11 (IHKA) Unit (White)	7100-14-03
X611	Connector (26 pins)	On A10 (HR) Unit or A11 (IHKA) Unit (Green)	7100-14-03
X612	Connector	On S26 Automatic Heating and Air Conditioning Switch (IHKA) or S33 Heater Control Switch (HR) (Blue)	
X613	Connector (26 pins)	On A10 (HR) Unit or A11 (IHKA) Unit (Blue)	7100-13-01
X614	Connector (26 pins)	On A10 (HR) Unit or A11 (IHKA) Unit (Yellow)	7100-13-01
X619	Connector (12 pins)	Under rear seat	
X621	Connector (10 pins)	Ahead of RH front door, in wire grommet	7100-12-03
X622	Connector (10 pins)	Ahead of LH front door, in wire grommet	7100-12-03
X626	Connector (8 pins)	Under driver's seat	7100-28-01
X627	Connector (8 pins)	In center of windshield header, near rear view mirror	7100-10-03
X628	Connector (3 pins)	In RH corner of luggage compartment	Not in US
X629	Connector (8 pins)	On A14 Park Heating/Ventilation Control Unit (Natural)	
X630	Connector (13 pins)	Rear f car	7100-10-02
X634	Connector (6 pins)	Underside of RH rear seat	7100-32-03
X635	Connector (6 pins)	Underside of LH rear seat	7100-32-03
X638	Connector (6 pins)	Below luggage compartment, right of spare tire	7100-00-01
X642	Connector (6 pins)	On A14 Park Heating/Ventilation Control Unit (Black)	
X648	Connector (6 pins)	On A21 Memory Seats/Mirrors Control Unit (Black)	7100-28-01
X649	Connector (6 pins)	On A21 Memory Seats/Mirrors Control Unit (White)	7100-28-01
X653	Connector (6 pins)	On A21 Memory Seat/Mirrors Control Unit (Black)	7100-27-03
X654	Connector (6 pins)	On A21 Memory Seats/Mirrors Control Unit (White)	7100-27-03
X655	Connector (6 pins)	On A21 Memory Seats/Mirrors Control Unit (Blue)	7100-27-03
X656	Connector (6 pins)	On A21 Memory Seats/Mirrors Control Unit (Green)	7100-27-03
X657	Connector (6 pins)	On A21 Memory Seats/Mirrors Control Unit (Brown)	7100-27-03



COMPONENT LOCATION CHART

X659	Connector (6 pins)	Below passenger's seat	7100-29-01
X672	Connector (4 pins)	On A20 Booster/Amplifier	
X673	Connector (4 pins)	Under rear seat	
X674	Connector (4 pins)	Under rear seat	
X681	Connector (3 pins)	Behind glove box	7100-15-03
X682	Connector (3 pins)	On S26 Automatic Heating and Air Conditioning Switch (IHKA) or S33 Heater Control Switch (HR) (Natural)	
X683	Connector (3 pins)	By driver's footrest, behind speaker	Not in US
X684	Connector (3 pins)	In passenger's door, near door handle (Black)	7100-29-03
X685	Connector (3 pins)	In driver's door, near door handle (Black)	7100-29-03
X692	Connector (3 pins)	In center of dash, behind LH side of radio	7100-21-01
X693	Connector (3 pins)	On S26 Automatic Heating and Air Conditioning Switch (IHKA) or S33 Heater Control Switch (HR) (Black)	
X702	Connector (2 pins)	On A20 Booster/Amplifier	
X703	Connector (2 pins)	On A20 Booster/Amplifier	
X705	Connector (2 pins)	Below car, near RH rear suspension frame attachment point	
			7100-18-02
X713	Connector (2 pins)	At RH rear wheel, above brake caliper	7100-09-03
X716	Connector (2 pins)	In LH rear door	7100-31-03
X717	Connector (2 pins)	In LH rear door	7100-31-03
X722	Connector (2 pins)	In RH rear door	7100-31-03
X723	Connector (2 pins)	In RH rear door	7100-31-03
X732	Connector (2 pins)	In driver's seatback	7100-31-02
X741	Connector (2 pins)	In passenger's seatback	7100-31-02
X742	Connector (2 pins)	In passenger's door, near door handle (Yellow)	7100-29-03
X747	Connector (2 pins)	In driver's door, near door handle (Yellow)	7100-29-03
X751	Connector (2 pins)	In driver's door, near door handle (White)	7100-29-03
X752	Connector (2 pins)	In driver's door, near door handle (Blue)	7100-29-03
X755	Connector (2 pins)	LH side of engine	7100-32-02
X756	Connector (2 pins)	RH rear wheel well	7100-22-02
X757	Connector (2 pins)	On E50 Park Heating Unit (Natural)	
X759	Connector (2 pins)	RH side of passenger's footwell, behind speaker panel	Not in US



COMPONENT LOCATION CHART

X764	Connector (2 pins)	On A14 Park Heating/Ventilation Control Unit (Natural)	
X770	Connector (2 pins)	Below front of car	7100-25-02
X778	Connector (2 pins)	Near base of passenger's seat belt	
X779	Charging Plug	On LH side of glove box	
X783	Connector (2 pins)	Below steering column	7100-17-01
X784	Connector (2 pins)	Under LH side of dash, at base of steering column	7100-26-02
X785	Connector (2 pins)	LH side of engine	7100-32-02
X787	Connector (2 pins)	Below car, above rear of differential	Not in US
X795	Connector (2 pins)	Underside of LH rear seat	7100-32-03
X797	Connector (2 pins)	Underside of RH rear seat	7100-32-03
X811	Ground	Below rear seat, by right side of battery	7100-16-03
X813	Connector (1 pin)	On A20 Booster/Amplifier	
X814	Ground	Below RH side of rear seat	
X815	Connector (1 pin)	On A20 Booster/Amplifier	
X818	Ground	Below LH side of dash, left of steering column	7100-32-01
X820	Ground	Under RH side of rear seat, right of battery	7100-16-03
X905	Ground	Under RH side of rear seat	7100-19-02
X907	Connector (6 pins)	Below LH side of dash, left of steering column	Not in US
X910		LH rear side of engine compartment	7100-34-03
X926	Connector (3 pins)	Near LH side of HR plenum	
X960		Front of driver's footwell, going through firewall	7100-39-02
X961		Right rear corner of engine compartment	7100-39-03
X1521	Connector (3 pins)	Top front of engine, on RH side	7100-38-03
X1522	Connector (3 pins)	Top front of engine, on RH side	7100-38-03
X1523	Connector (4 pins) (735i/735iL)	Lower left rear side of engine	7100-23-03
X1523	Connector (8 pins) (750iL)	In E-Box, behind RH front shock tower	7100-34-01
X1532	Diagnostic Connector (20 pins) (735i/735iL)	RH rear of engine compartment, ahead of shock tower	7100-01-03
X1532	Diagnostic Connector (20 pins) (750iL)	LH rear of engine compartment, right of shock tower	7100-34-03
X1533	Connector (3 pins) (735i/735iL)	Lower left rear side of engine	7100-23-03
X1533	Connector (3 pins) (750iL)	LH rear of engine compartment	7100-40-01
X1537	Connector (8 pins) (750iL)	In Auxiliary Relay Box, front of RH front shock tower	7100-24-01
X1537	Connector (8 pins) (735i/735iL)	In E-Box, behind RH front shock tower	7100-01-01



COMPONENT LOCATION CHART

X1540		RH rear of engine compartment	7100-01-01
X1541	Ground (Electronic)	RH rear of engine compartment, near shock tower	7100-01-03
X1542	Ground (Final Stage)	RH rear of engine compartment, near shock tower	7100-01-03
X1543		In Auxiliary Relay Box, front of RH front shock tower	7100-24-01
X1551	Connector (2 pins)	In E-Box, behind RH front shock tower	7100-34-01
X1552	Connector (4 pins)	In E-Box, behind RH front shock tower	7100-34-01
X1610	Connector (6 pins)	LH front side of engine compartment	7100-36-02
X1611	Connector (6 pins)	RH front of engine compartment	7100-36-01
X1612	Connector (3 pins)	Front of engine, near top of fan housing	7100-35-01
X1613	Connector (3 pins)	Front of engine, near top of fan housing	7100-35-01
X1614	Connector (3 pins)	Front of engine, near top of fan housing	7100-35-01
X1615	Connector (3 pins)	Front of engine, near top of fan housing	7100-35-01
X1618	Connector (8 pins)	LH front side of engine compartment	7100-36-02
X1619	Connector (8 pins)	RH front of engine compartment	7100-36-03
X1620	Ground	RH rear of engine compartment, near shock tower	7100-37-03
X1621	Ground	RH rear of engine compartment, near shock tower	7100-37-03
X1623	Connector (8 pins)	In E-Box, behind RH front shock tower	7100-34-01
X2001	Connector (12 pins)	Behind glove box, in RH corner	7100-33-01
X2005	Connector (8 pins)	On LH side of transmission	7100-07-03
X2008	Ground	Below RH side of rear seat, right of battery	7100-19-02

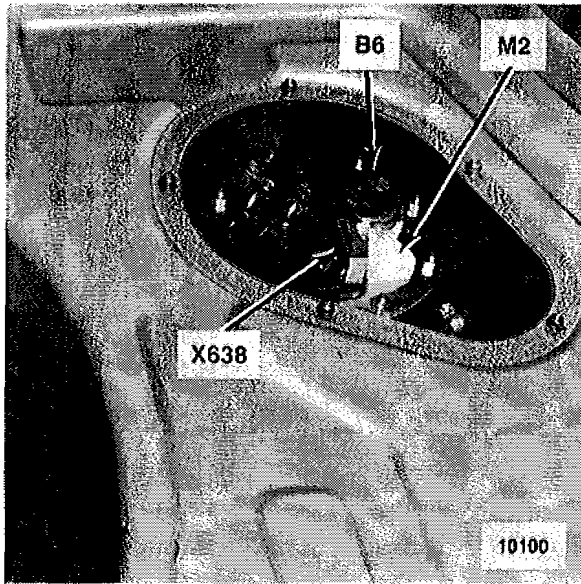

Figure 1- RH Side Of Luggage Compartment

- B6 Fuel Tank Sensor**
- M2 Fuel Pump (In Tank)**
- X638 Connector (6 pins)**

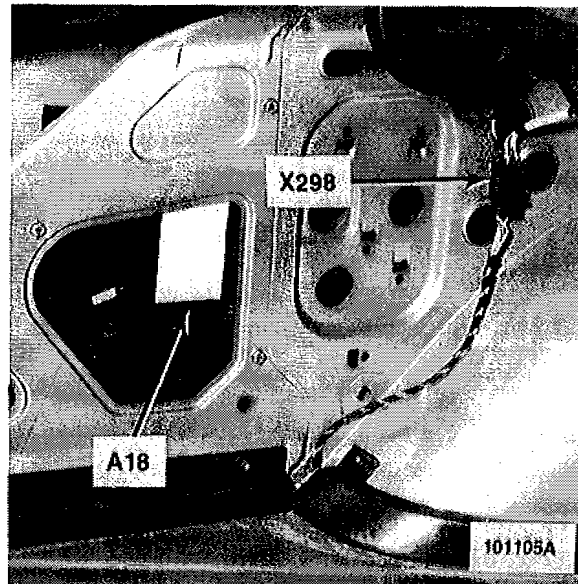

Figure 2- LH Front Of Luggage Compartment

- A18 HIFI Amplifier**
- X298 Connector (8 pins)**

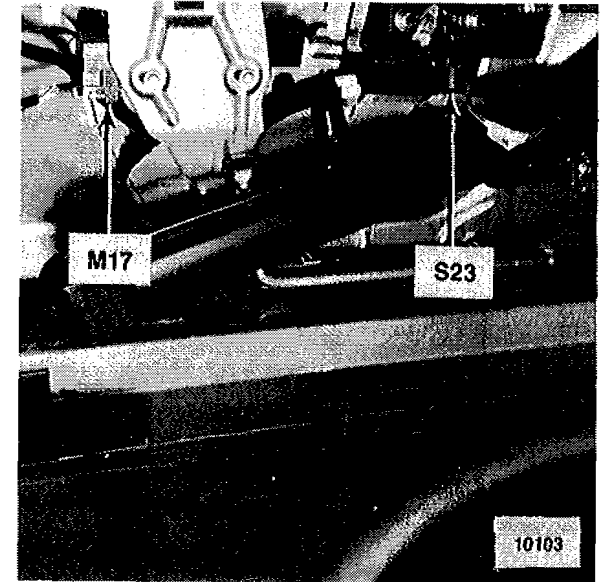

Figure 3- In Luggage Compartment, On Rear Panel

- M17 Trunk Lock Motor**
- S23 Trunk Lid Switch**

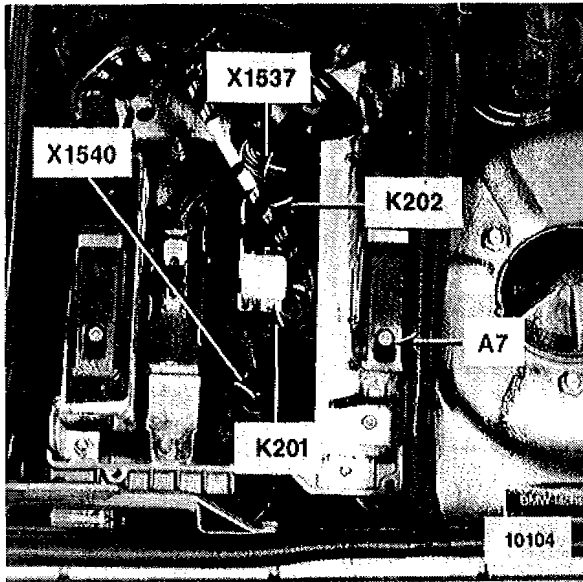

Figure 1- RH Rear Of Engine Compartment (735i/735iL)

- A7 ABS Electronic Control Unit
- K201 Fuel Pump Relay
- K202 Main Relay
- X1537 Connector (8 pins)
- X1540

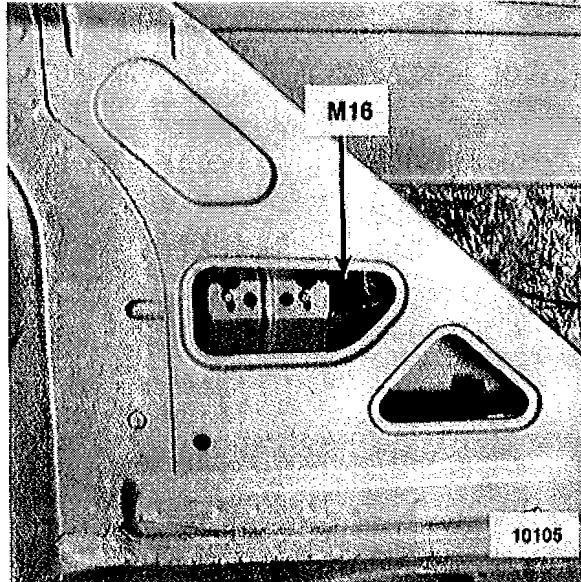

Figure 2- RH Side Of Luggage Compartment

- M16 Gas Filler Lock Motor

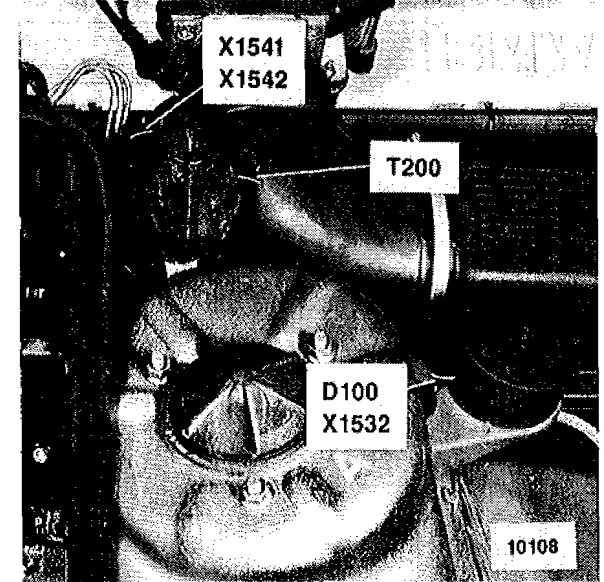

Figure 3- RH Rear Of Engine Compartment (735i/735iL)

- D100 Diagnostic Connector
- T200 Ignition Coil
- X1532 Diagnostic Connector (20 pins)
- X1541 Ground (Electronic)
- X1542 Ground (Final Stage)

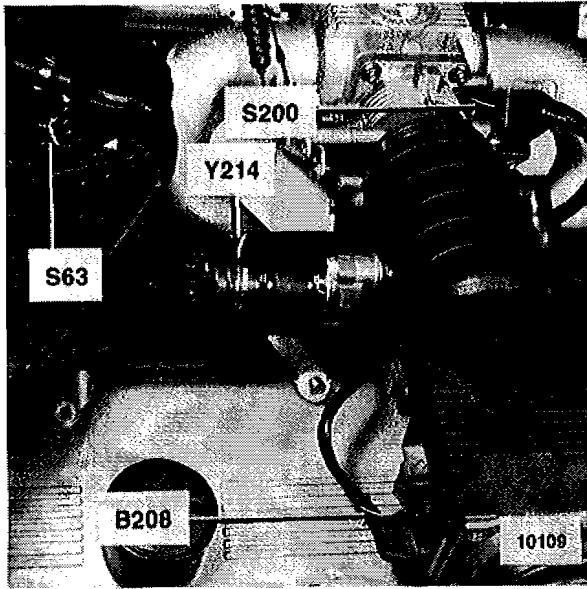

Figure 1- Top Rear Of Engine (735i/735iL)

- B208** Air Flow Meter
- S63** Coolant Level Switch
- S200** Throttle Switch
- Y214** Idle Speed Actuator

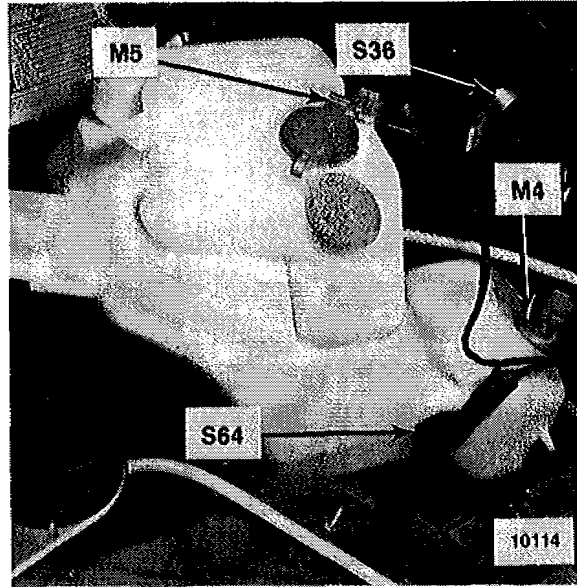

Figure 2- RH Front Of Engine Compartment (735i/735iL Shown, 750iL Similar)

- M4** Washer Pump
- M5** Intensive Wash Pump
- S36** Temperature Switch
- S64** Washer Fluid Level Switch

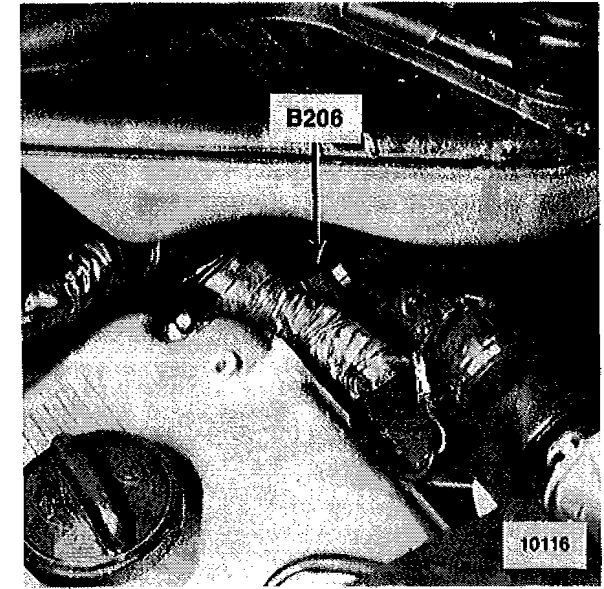

Figure 3- Rear Of Engine (735i/735iL)

- B206** Oil Pressure Switch

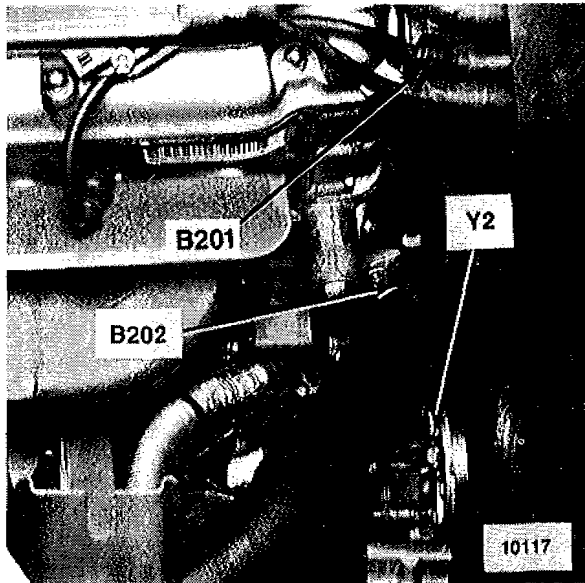

Figure 1- RH Front Of Engine (735i/735iL)

- B201** Cylinder Identification Sensor
- B202** Engine Speed/Reference Point Sensor
- Y2** Compressor Clutch (IHKA)

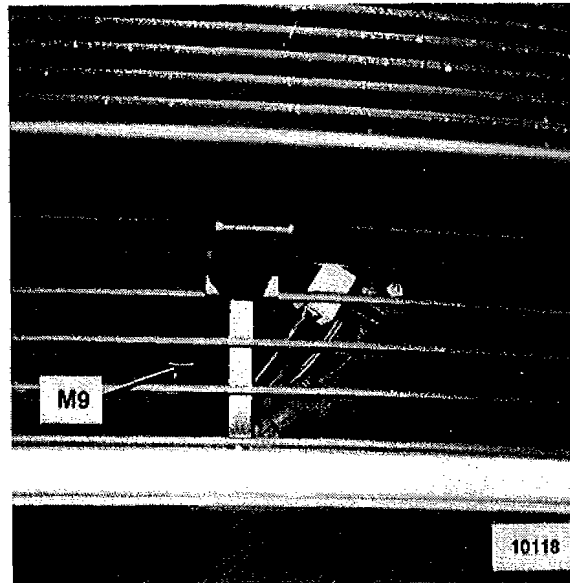

Figure 2- Front Of Car

- M9** Auxiliary Fan Motor

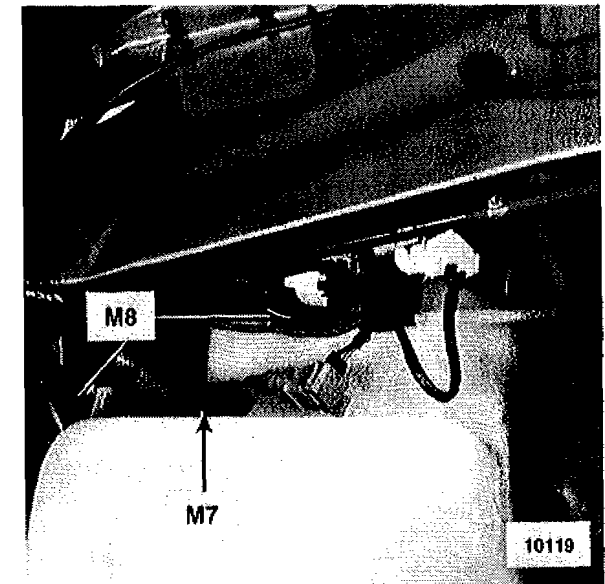

Figure 3- LH Front Of Engine Compartment (735iL)

- M7** Headlight Washer Pump
- M8** Fog Light Washer Pump

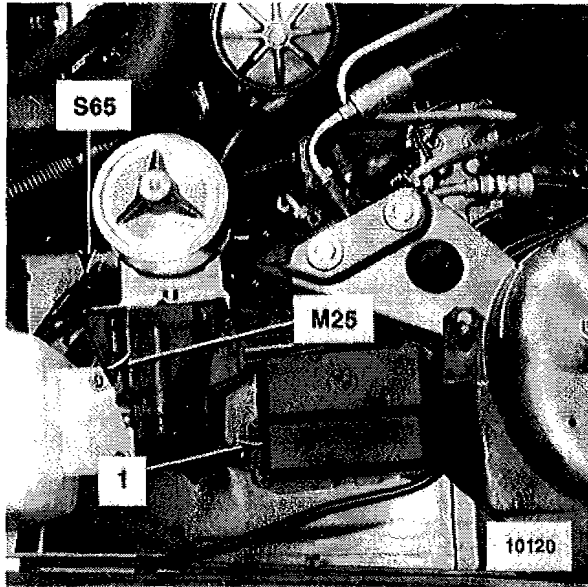

Figure 1- LH Side Of Engine Compartment (735i/735iL)

- 1** Auxiliary Relay Box
- M25** Cruise Control Actuator (Tempomat)
- S65** Power Steering Fluid Level Switch

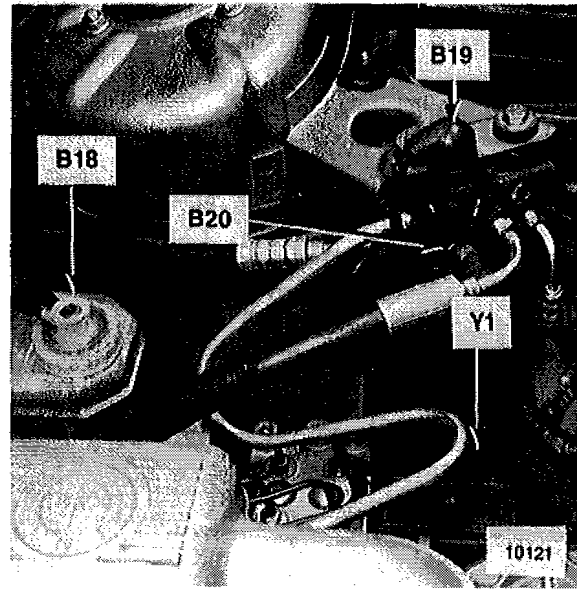

Figure 2- LH Side Of Engine Compartment (735i/735iL)

- B18** Brake Fluid Level Switch
- B19** Brake Pressure Regulating Switch
- B20** Brake Pressure Switch
- Y1** ABS Hydraulic Unit

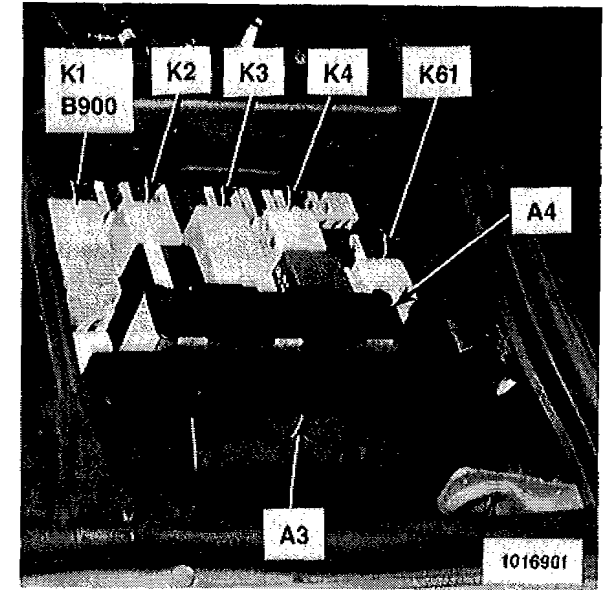

Figure 3- LH Side Of Engine Compartment

- A3** Lamp Control Module
- A4** Check Control Module
- B900** Jumper Plug (Manual)
- K1** Starter Relay (Automatic)
- K2** Horn Relay
- K3** Unloader Relay, KLR
- K4** Blower Relay
- K61** Unloader Relay

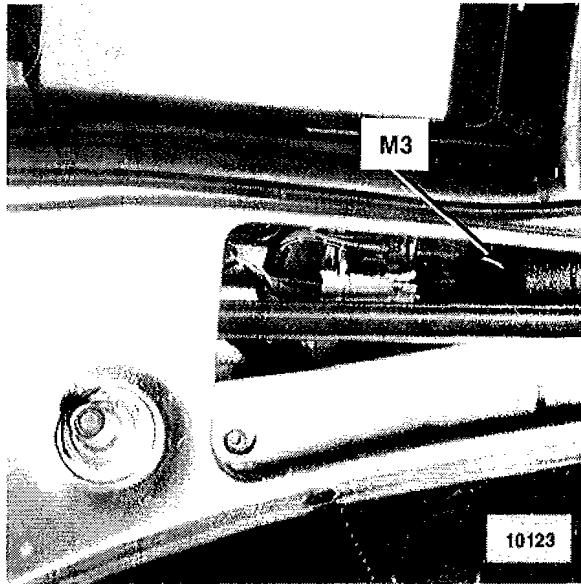

Figure 1- Below LH Fresh Air Cowl

M3 Wiper Motor

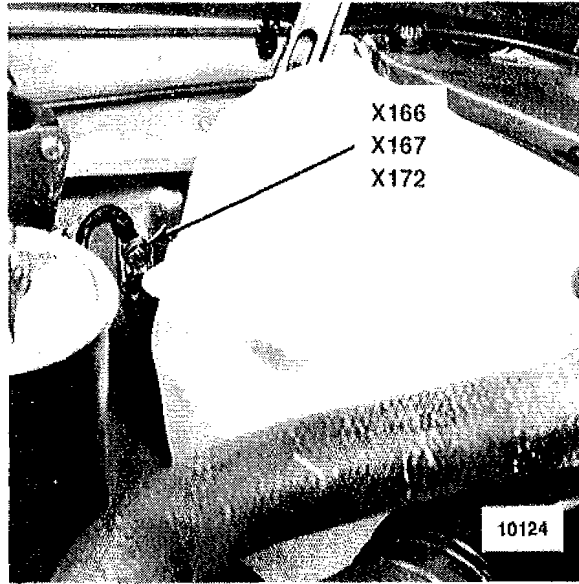

Figure 2- LH Front Of Engine Compartment (735i/735iL)

X166 Ground
X167 Ground
X172 Ground

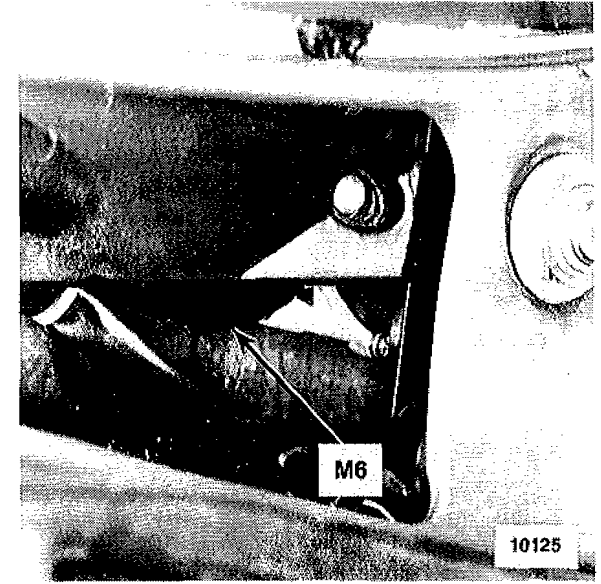

Figure 3- Below LH Fresh Air Cowl

M6 Wiper Pressure Control Motor (ADV)

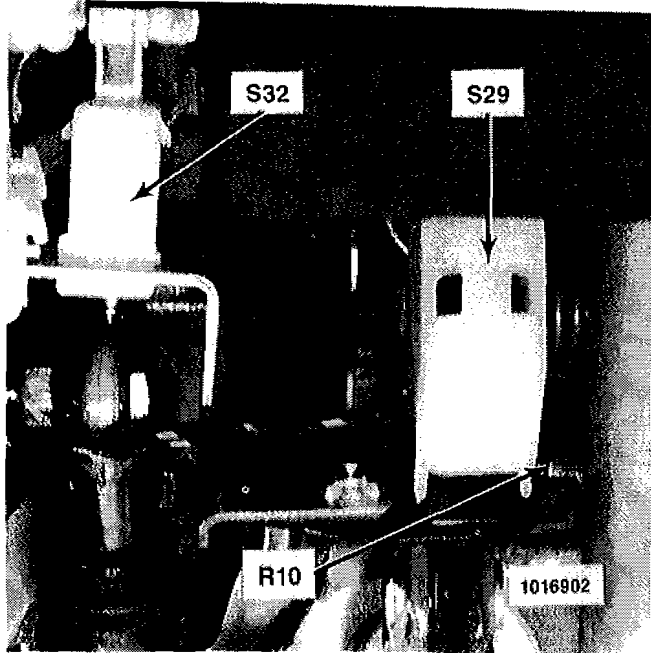

Figure 1- Under LH Side Of Dash

- R10 Pedal Position Sensor**
- S29 Brake Light Switch**
- S32 Clutch Switch**

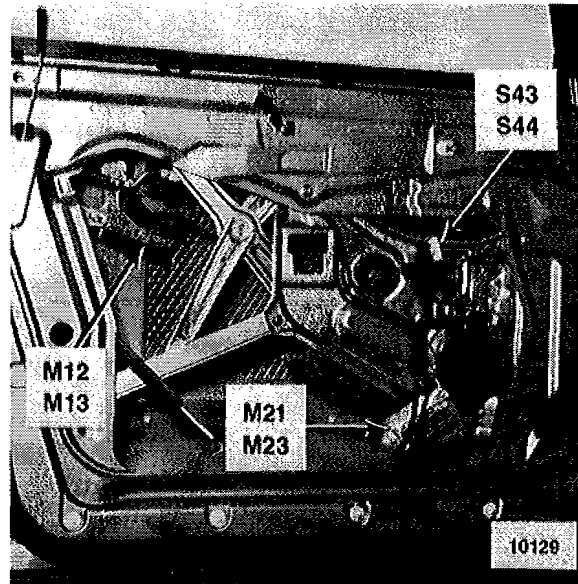

Figure 2- Behind Door Panel (Driver's Shown, Passenger's Similar)

- M12 Driver's Door Lock Motor**
- M13 Passenger's Door Lock Motor**
- M21 Driver's Window Motor**
- M23 Passenger's Window Motor**
- S43 Driver's Window Limit Switch**
- S44 Passenger's Window Limit Switch**

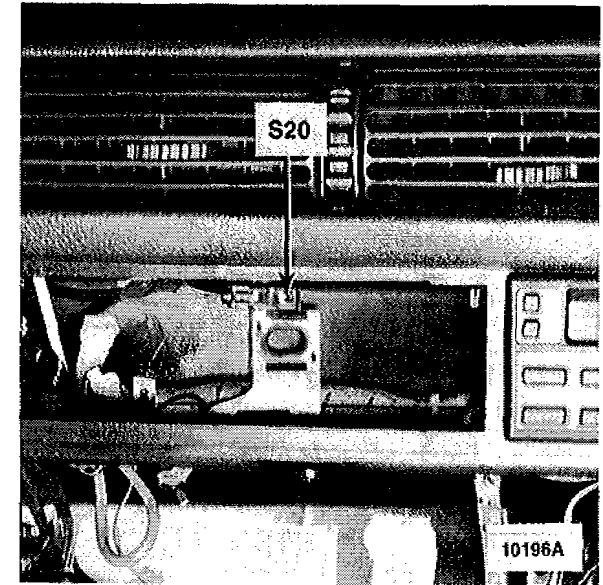

Figure 3- Center Of Dash (Radio Removed)

- S20 Radio Antitheft Switch (DWA)**



COMPONENT LOCATION VIEWS

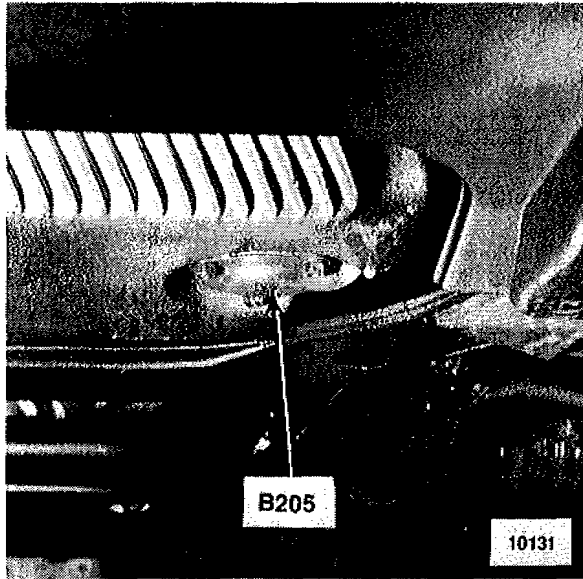

Figure 1- Under Front Of Car (735i/735iL Shown, 750iL Similar)

B205 Oil Level Sensor

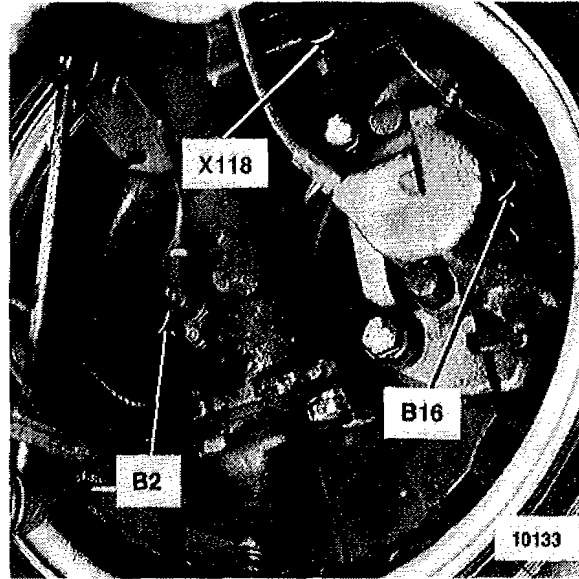

Figure 2- Behind LH Front Wheel

B2 Left Front Speed Sensor
B16 Left Front Brake Pad Sensor
X118 Connector (2 pins)

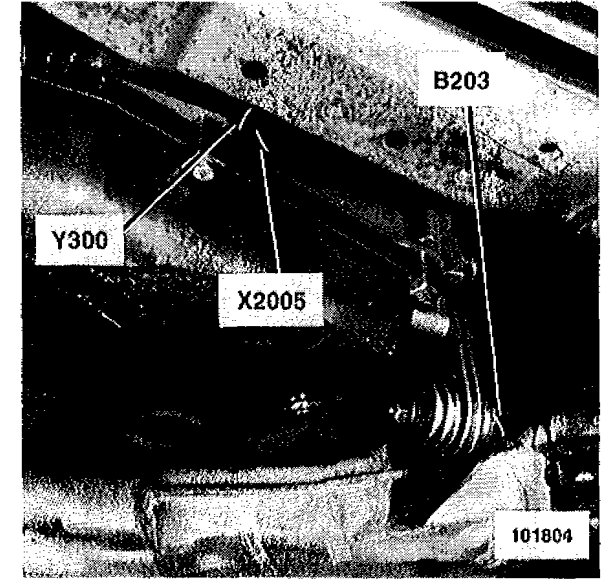

Figure 3- On LH Side Of Transmission (735i/735iL Shown, 750iL Similar)

B203 Oxygen Sensor
Y300 Transmission
X2005 Connector (8 pins)

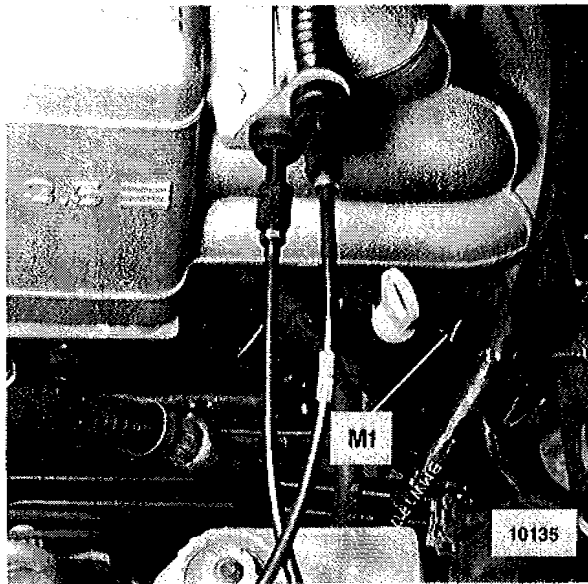

Figure 1- LH Side Of Engine (735i/735iL)

M1 Starter

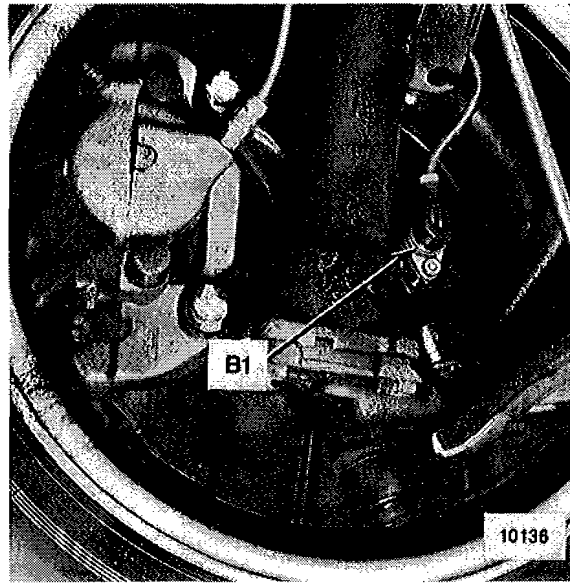

Figure 2- Behind RH Front Wheel

B1 Right Front Speed Sensor

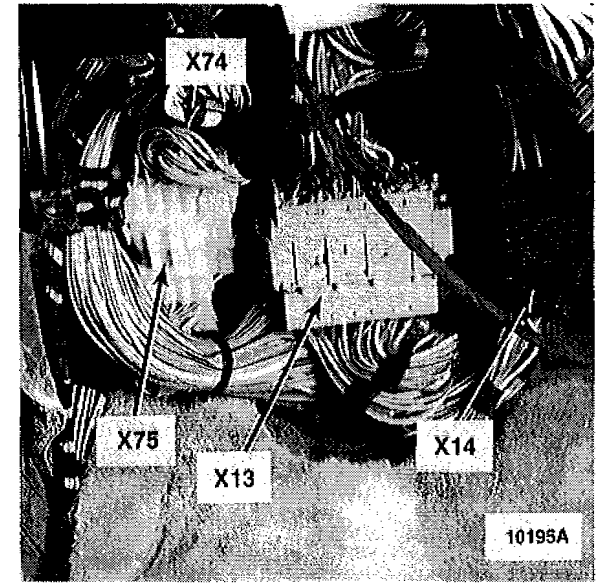

Figure 3- Below LH Side Of Dash

- X13 Connector (30 pins) BL**
- X14 Connector (30 pins) SW**
- X74 Connector (8 pins)**
- X75 Connector (6 pins)**

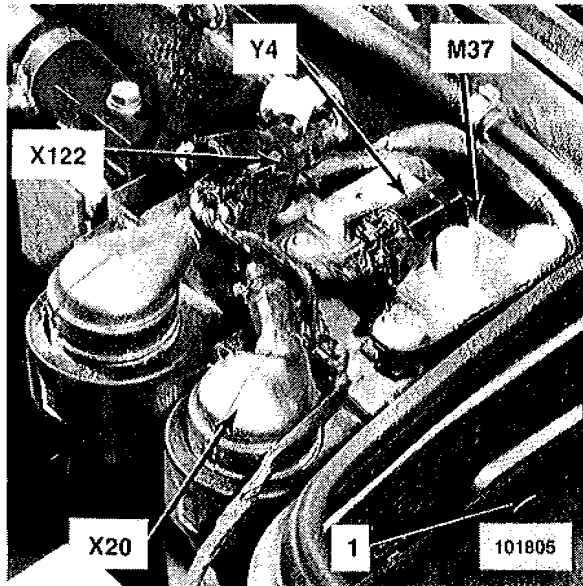

Figure 1- LH Rear Of Engine Compartment (735i/735iL)

- 1** Front Power Distribution Box
- M37** Water Pump
- Y4** Water Valve Assembly
- X20** Connector (20 pins)
- X21** Connector (20 pins)
- X122** Connector (2 pins)

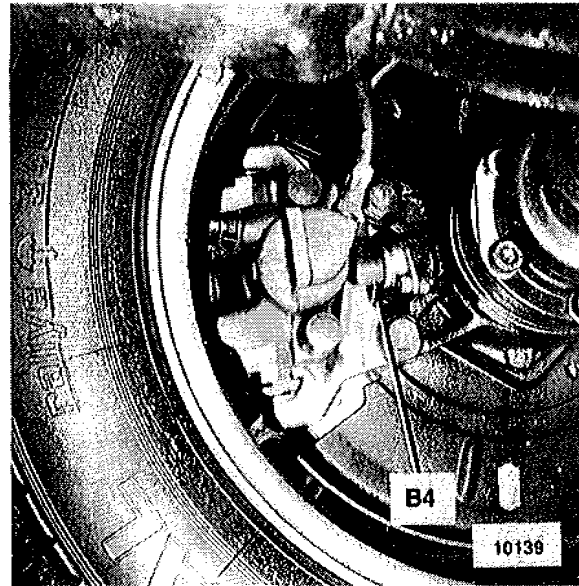

Figure 2- Behind LH Rear Wheel

- B4** Left Rear Speed Sensor

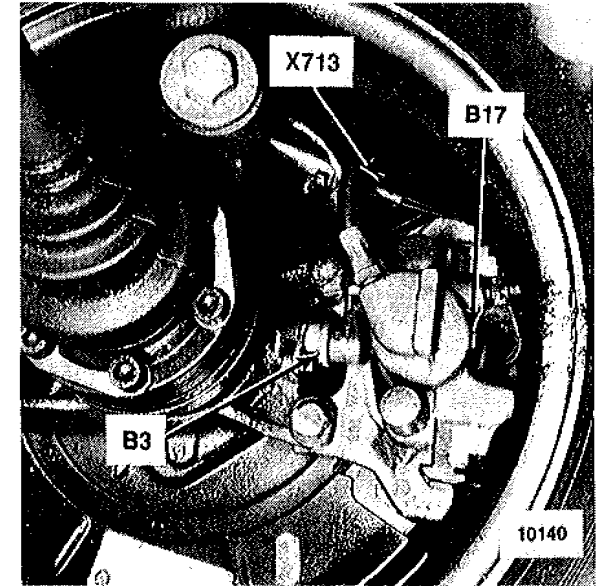

Figure 3- Behind RH Rear Wheel

- B3** Right Rear Speed Sensor
- B17** Right Rear Brake Pad Sensor
- X713** Connector (2 pins)

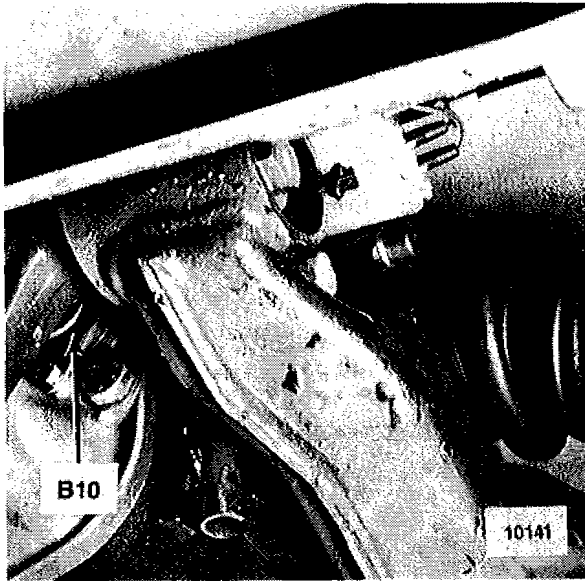

Figure 1- Rear Of Car, On Differential
B10 Vehicle Speed Sensor

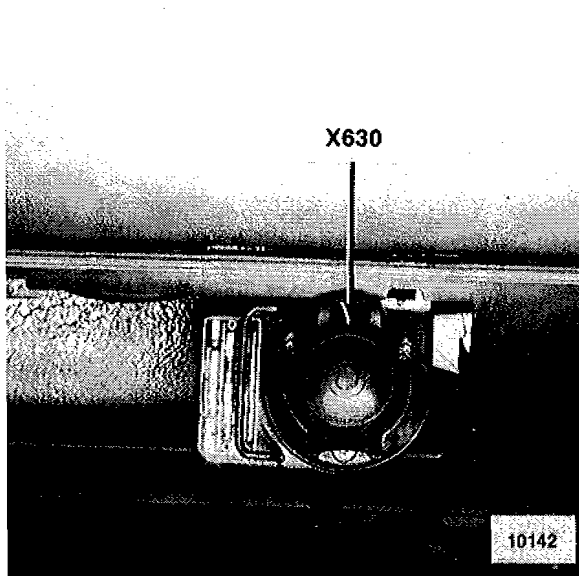

Figure 2- Rear Of Car
X630 Connector (13 pins)

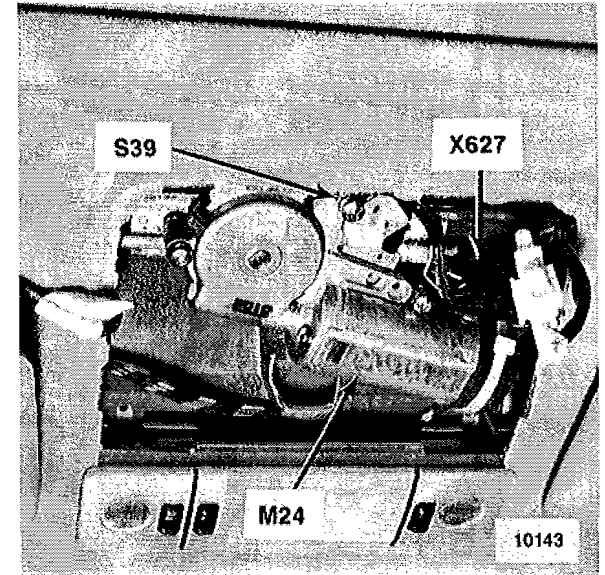

Figure 3- In Center Of Windshield Header
M24 Sunroof Motor
S39 Sunroof Position Switch
X627 Connector (8 pins)

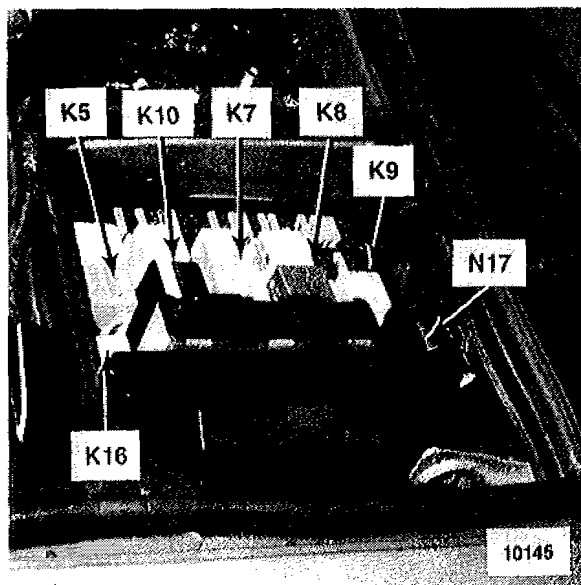

Figure 1- LH Rear Of Engine Compartment

- K5 Washer Pump Relay
- K7 Parking Light Monitor Relay
- K8 Front Defogger/Water Pump Relay
- K9 Unloader Relay, KL15
- K10 ABS Relay
- K16 Hazard Flasher Relay (Removed)
- N17 Crash Control Unit (Removed)

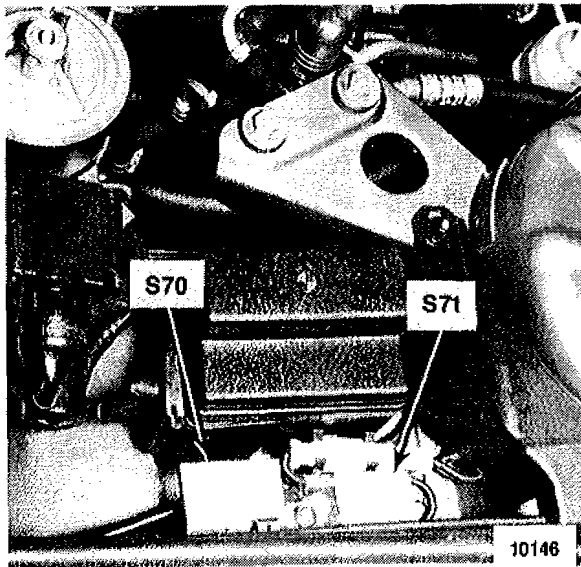

Figure 2- Top Of LH Front Wheel Well

- S70 Safety Switch
- S71 Left Front Crash Sensor

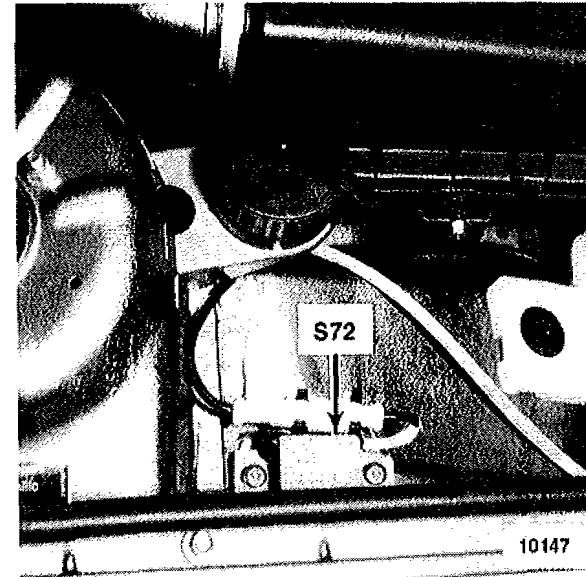

Figure 3- Top Of RH Front Wheel Well

- S72 Right Front Crash Sensor

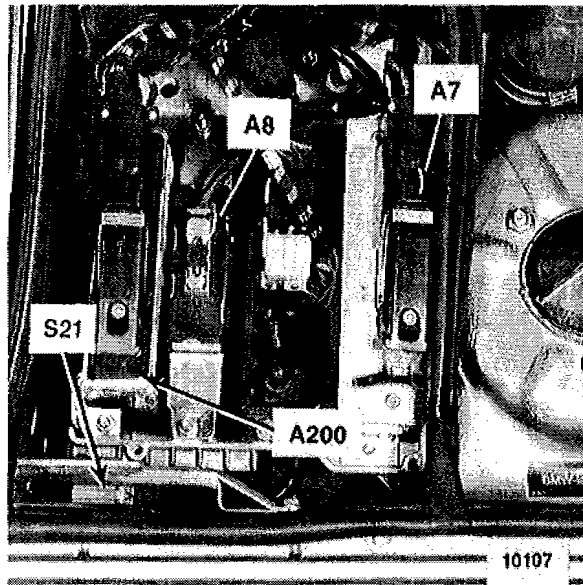

Figure 1- RH Rear Of Engine Compartment (735i/735iL)

- A7 ABS Electronic Control Unit
- A8 Cruise Control Module (Tempomat)
- A200 Motronic Control Unit (DME)
- S21 Engine Hood Switch

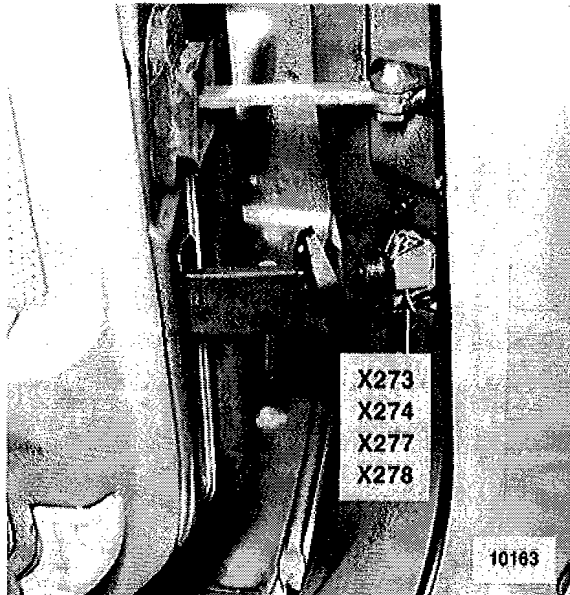

Figure 2- LH Rear Door Jamb (RH Similar)

- X273 Connector (LH) (12 pins)
- X274 Connector (RH) (12 pins)
- X277 Connector (LH) (10 pins)
- X278 Connector (RH) (10 pins)

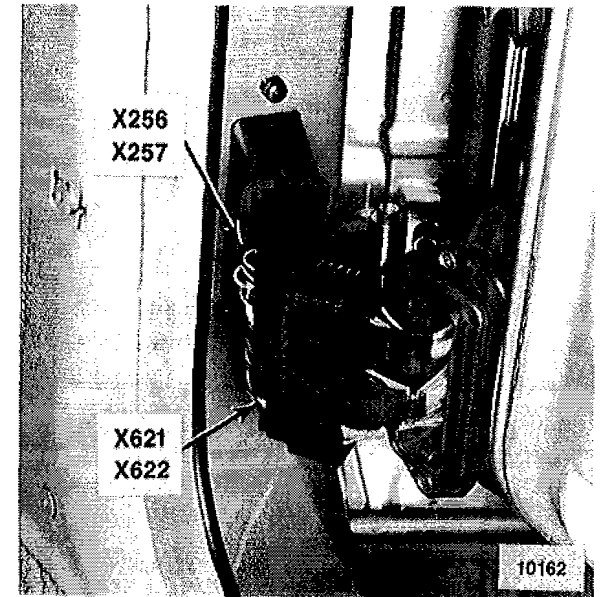

Figure 3- RH Front Door Jamb (LH Similar)

- X256 Connector (RH) (26 pins)
- X257 Connector (LH) (26 pins)
- X621 Connector (RH) (10 pins)
- X622 Connector (LH) (10 pins)

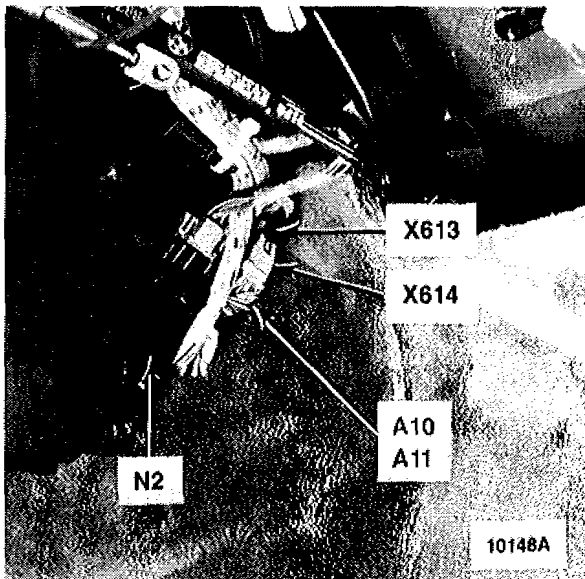

Figure 1- LH Side Of Passenger's Footwell

- A10 Electronic Heater Control Unit**
- A11 Automatic Heating and Air Conditioning Control Unit (IHKA)**
- N2 Final Stage Unit**
- X613 Connector (26 pins)**
- X614 Connector (26 pins)**

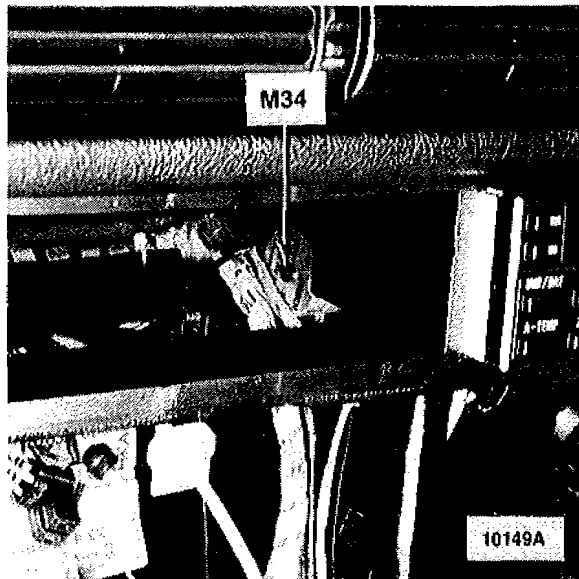

Figure 2- Center Of Dash (Radio Removed)

- M34 Right Mixing Flap Motor**

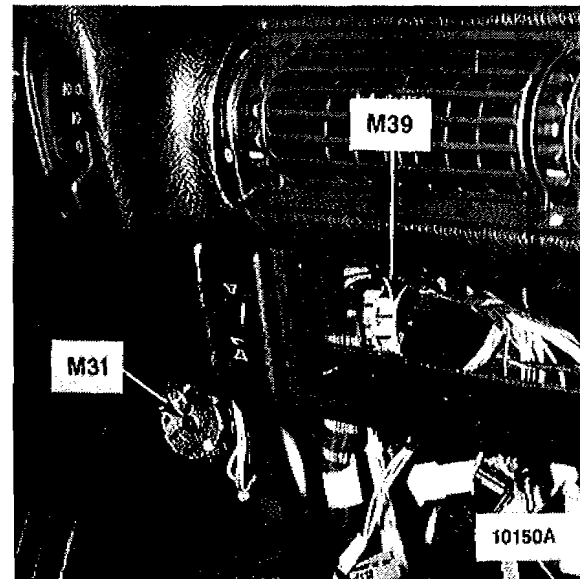

Figure 3- Center Of Dash (Radio Removed)

- M31 Left Footwell Flap Motor**
- M39 Left Mixing Flap Motor**

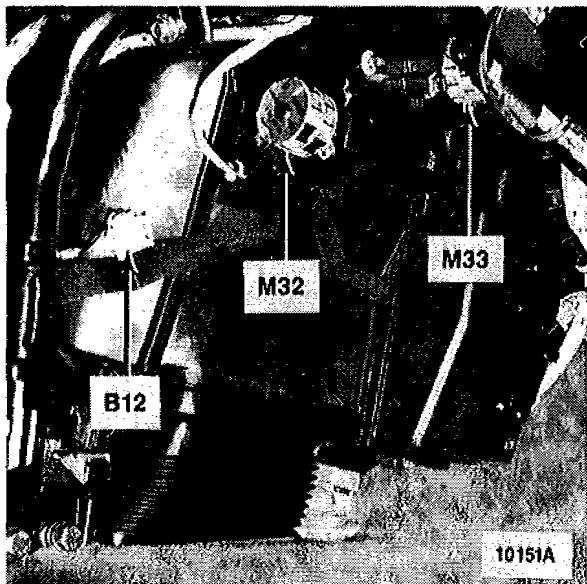

Figure 1- LH Side Of Passenger's Footwell

- B12** Right Heat Exchanger Temperature Sensor
- M32** Right Footwell Flap Motor
- M33** Right Ventilation Flap Motor

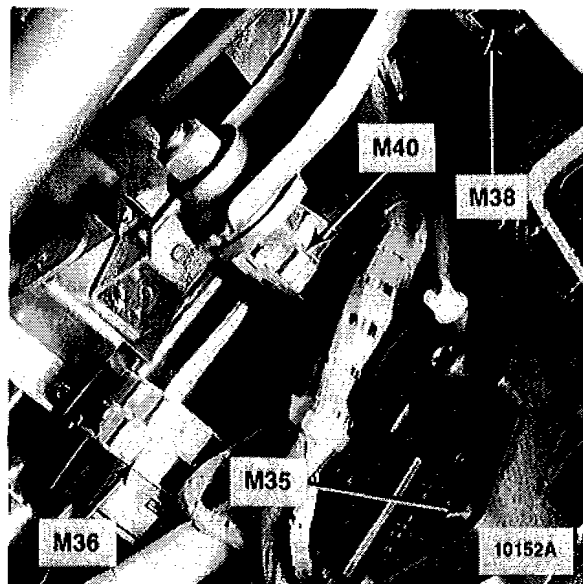

Figure 2- LH Side Of IHR/IHKA Plenum

- M35** Defroster Flap Motor
- M36** Fresh Air Flap Motor
- M40** Air Circulation Flap Motor

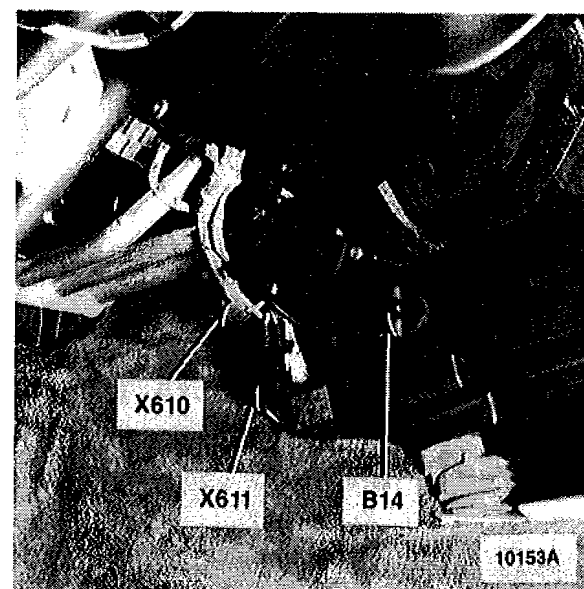

Figure 3- RH Side Of Driver's Footwell

- B14** Evaporator Temperature Sensor
- X610** Connector (26 pins)
- X611** Connector (26 pins)

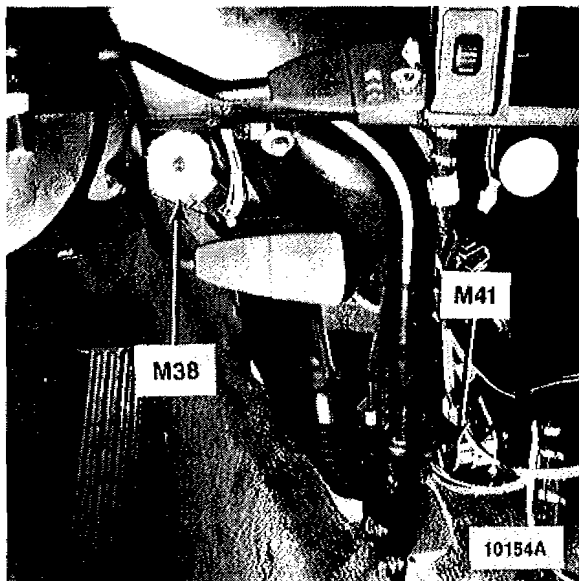

Figure 1- Front LH Side Of Console

- M38 Left Ventilation Flap Motor**
- M41 Rear Compartment Flap Motor**

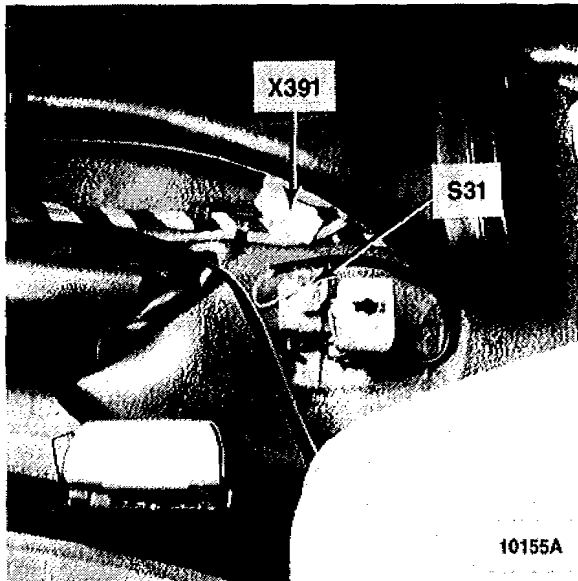

Figure 2- Below Center Console (Console Removed)

- S31 Park Brake Switch**
- X391 Connector (2 pins)**

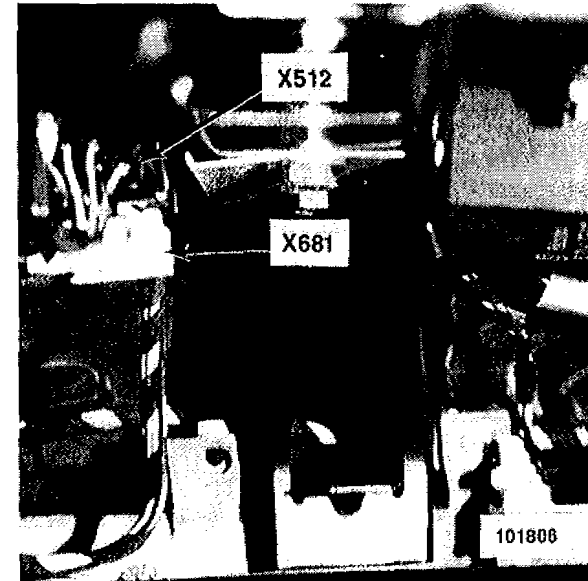

Figure 3- Behind Glove Box

- X512 Connector (8 pins)**
- X681 Connector (3 pins)**

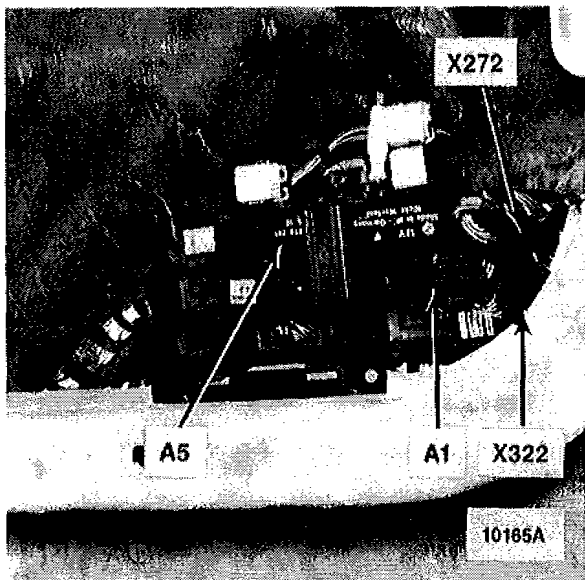

Figure 1- Below LH Side Of Rear Seat

- A1 General Module
- A5 Relay Module
- X272 Connector (12 pins)
- X322 Connector (6 pins)

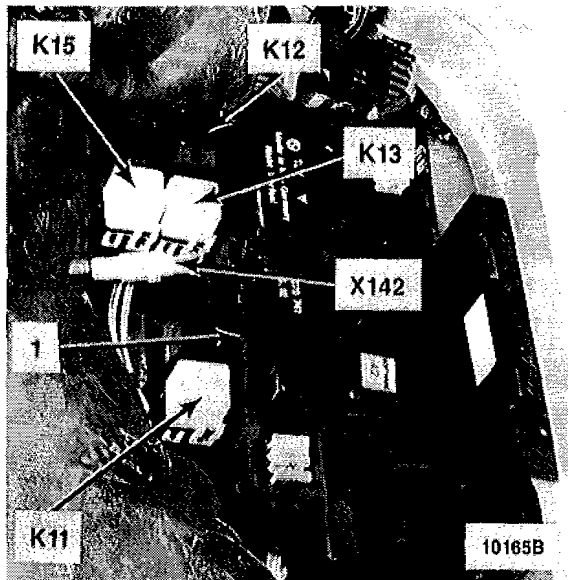

Figure 2- Below LH Side Of Rear Seat

- 1 Rear Power Distribution Box
- K11 Wiper Relay
- K12 Wiper Pressure Control Relay (ADV)
- K13 Rear Defogger Relay
- K15 Electric Power Production Relay
- X142 Connector (2 pins)

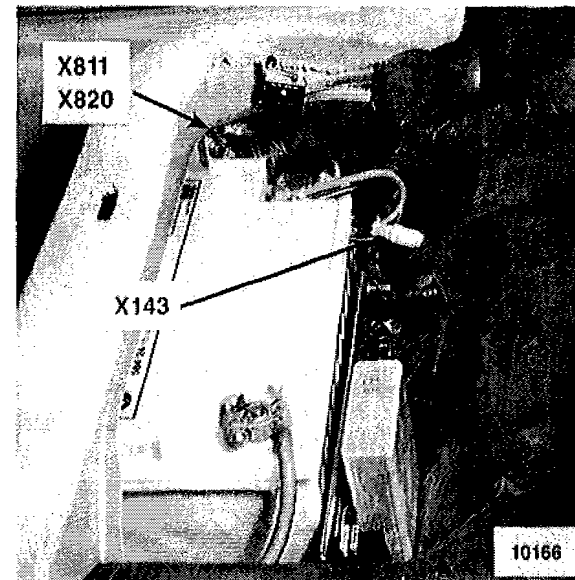

Figure 3- Below RH Side Of Rear Seat

- X143 Connector (2 pins)
- X811 Ground
- X820 Ground

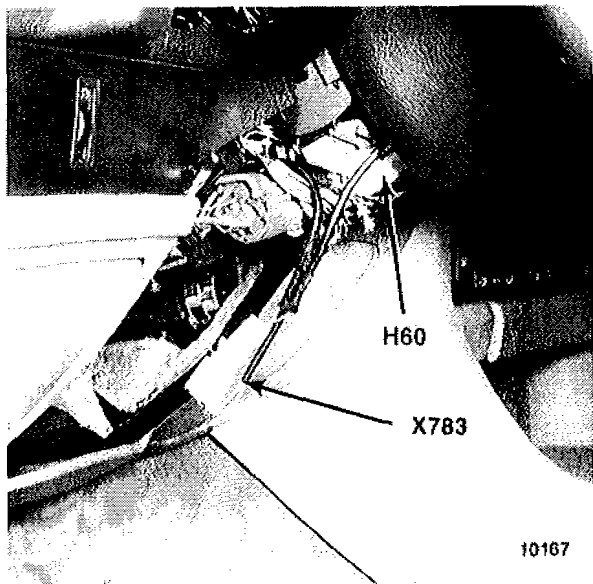

Figure 1- Underside Of Steering Column

- H60 Audible Turn Signal Relay
- X783 Connector (2 pins)

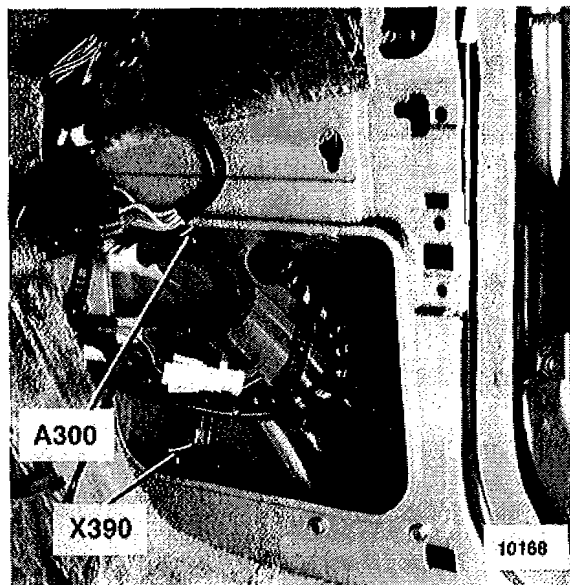

Figure 2- RH Side Of Passenger's Footwell, Behind Speaker Panel

- A300 Electronic Transmission Control Unit (AEGS)
- X390 Connector (2 pins)

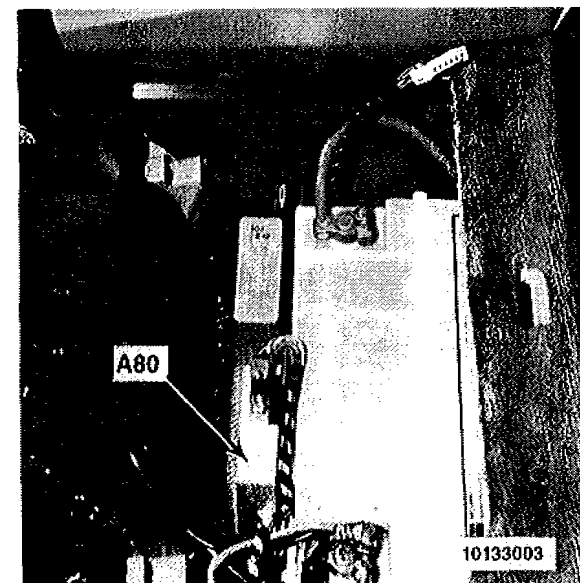

Figure 3- Below RH Side Of Rear Seat

- A80 EDC Electronic Control Unit (Not in US)

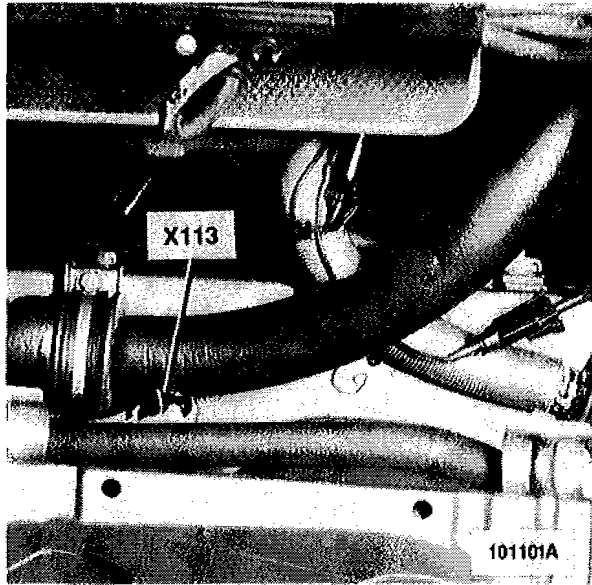

Figure 1- Lower RH Side Of Engine Compartment (735i/735iL)

X113 Connector (2 pins)

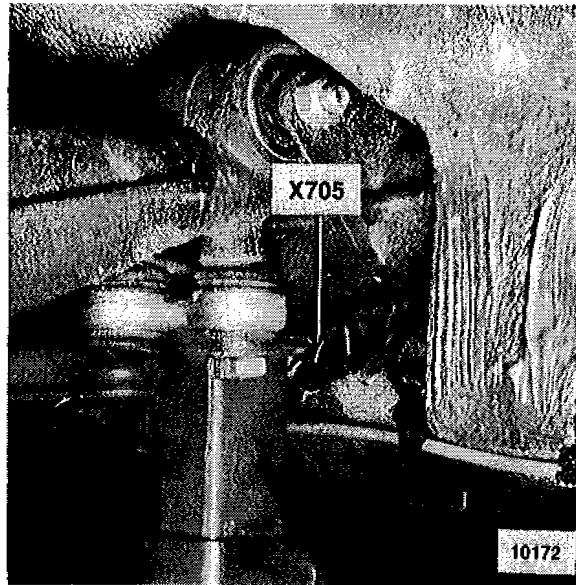

Figure 2- Front Of RH Rear Wheel Well

X705 Connector (2 pins)

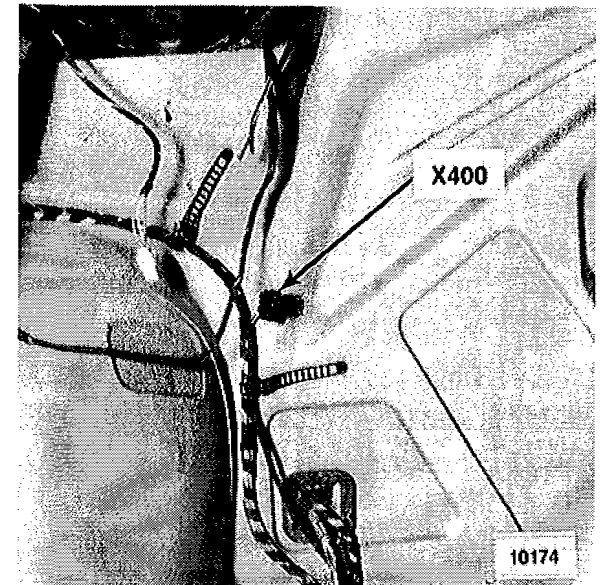

Figure 3- RH Rear Wheel Well (Behind Seat)

X400 Connector (3 pins)

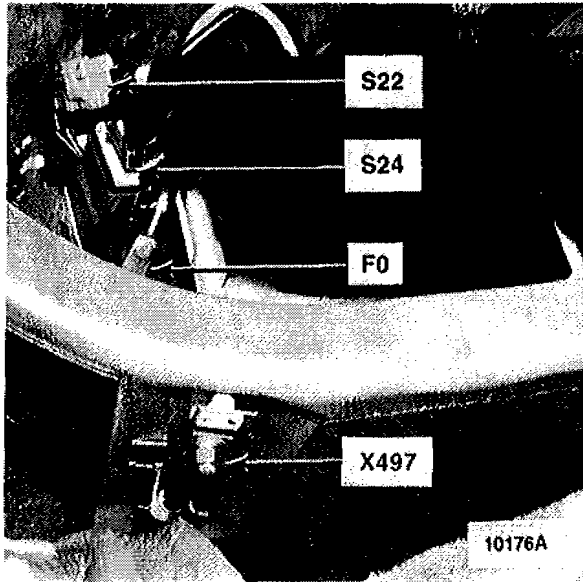

Figure 1- Under RH Side Of Rear Seat

- F0 Fusible Link (80 A)
- S22 Battery Switch
- S24 Rear Seat Switch
- X497 Ground (Battery)

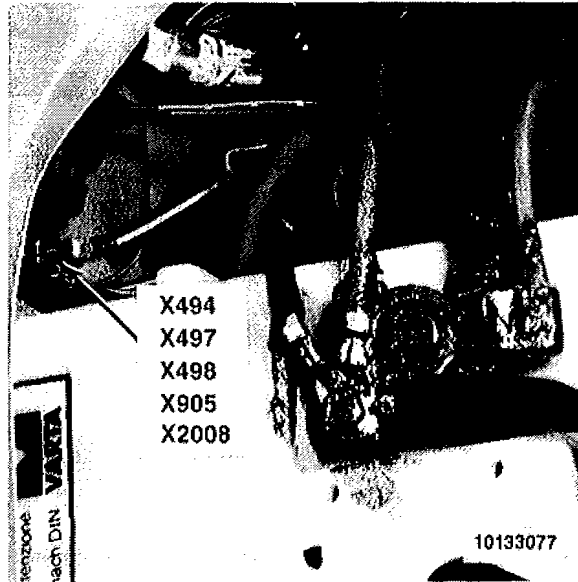

Figure 2- Under RH Side Of Rear Seat

- X494 Ground
- X497 Ground
- X498 Ground
- X905 Ground
- X2008 Ground

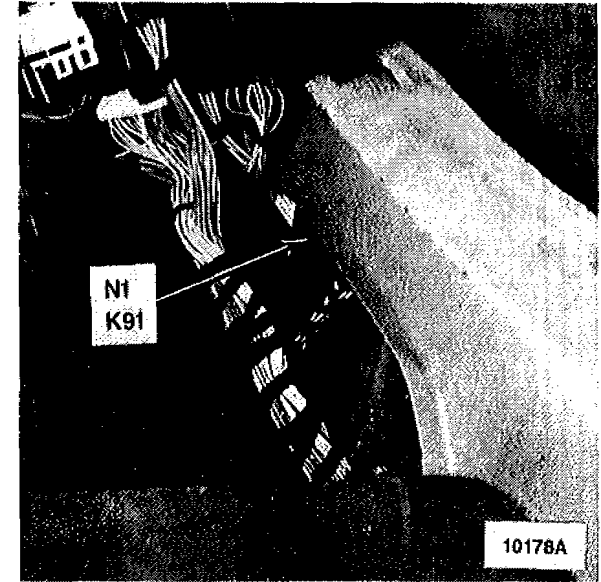

Figure 3- Under LH Side Of Rear Seat

- K91 On-Board Computer Horn Relay
- N1 Antitheft Module (DWA)

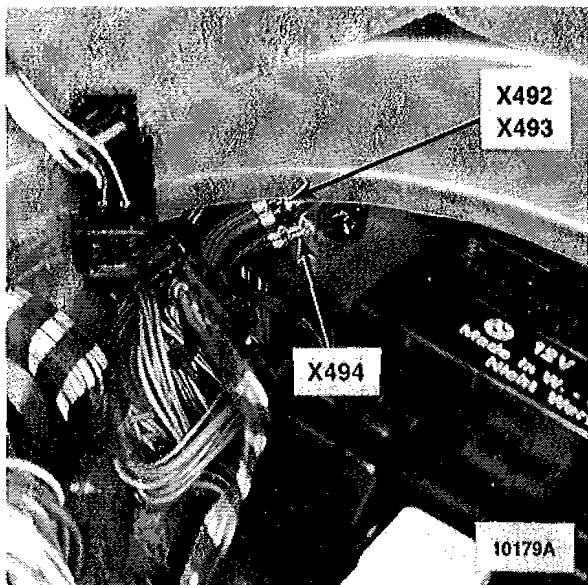

Figure 1- Under LH Side Of Rear Seat

X492 Ground
X493 Ground

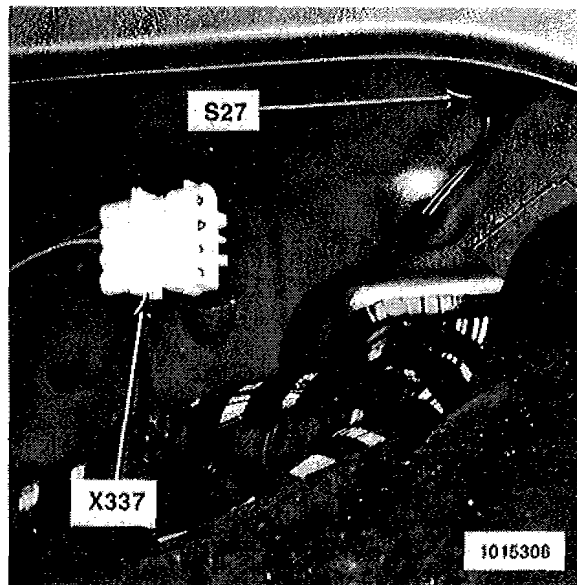

Figure 2- Below LH Side Of Rear Seat

S27 Inertia Switch
X337 Connector (4 pins)

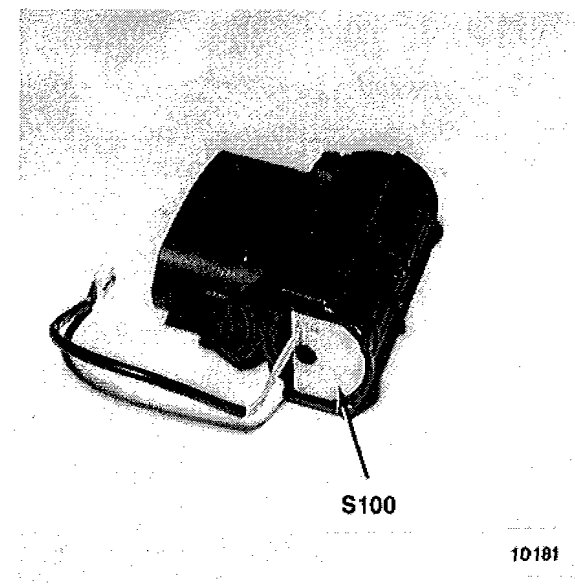

Figure 3- IHKA Rear Vent

S100 Rear Vent Flap Switch

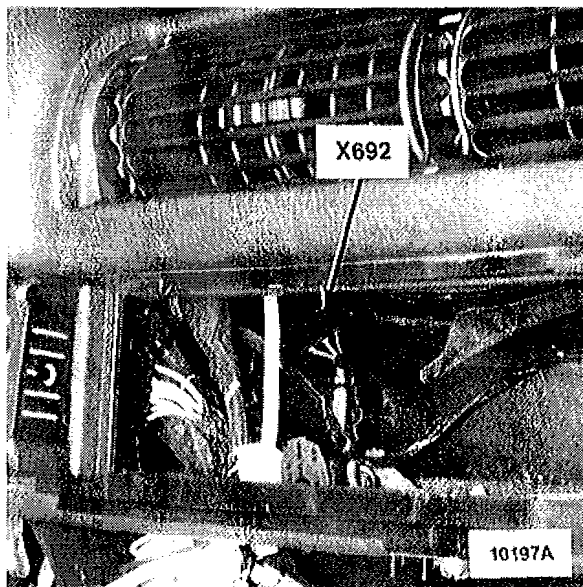

Figure 1- Center Of Dash (Radio Removed)

X692 Connector (3 pins)

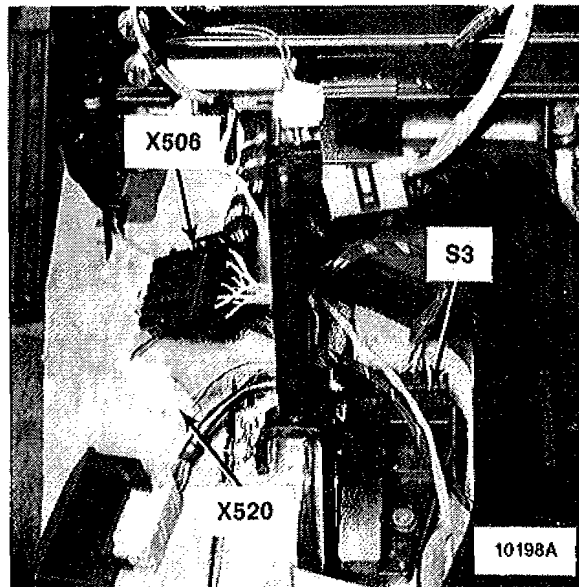

Figure 2- Under Center Console (Console Removed)

S3 Automatic Transmission Range Switch

X506 Connector (12 pins)

X520 Connector (3 pins)

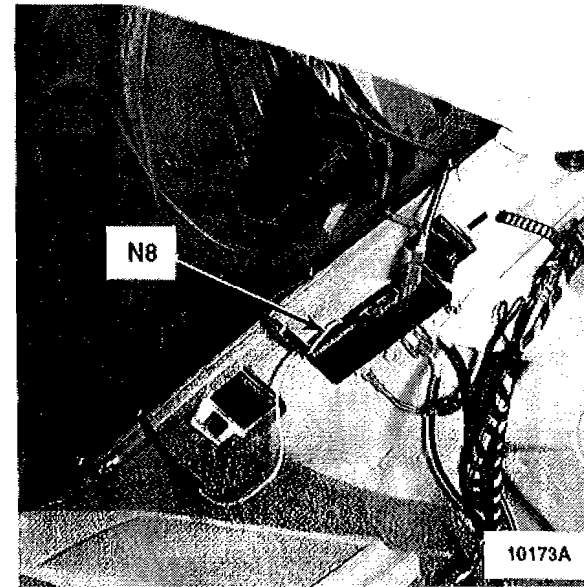

Figure 3- In LH C Pillar

N8 Antenna Amplifier

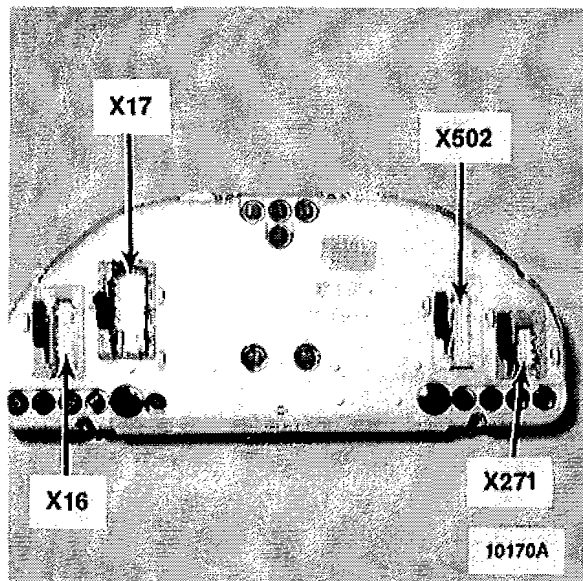

Figure 1- Rear Of Instrument Cluster

- X16 Connector (26 pins)
- X17 Connector (6 pins)
- X271 Connector (12 pins)
- X502 Connector (26 pins)

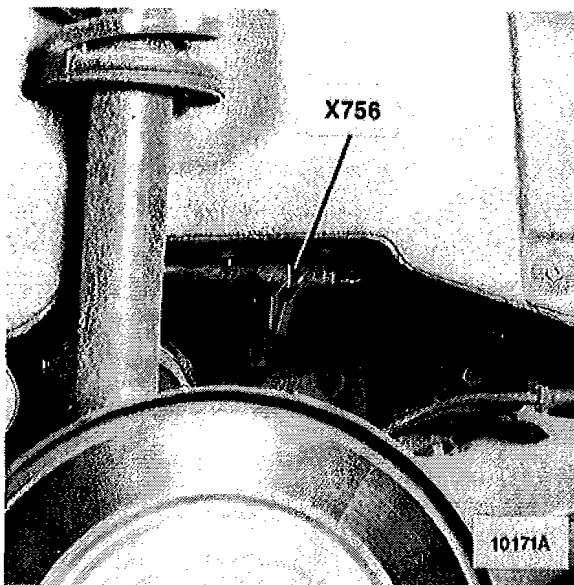

Figure 2- RH Rear Wheel Well

- X756 Connector (2 pins)

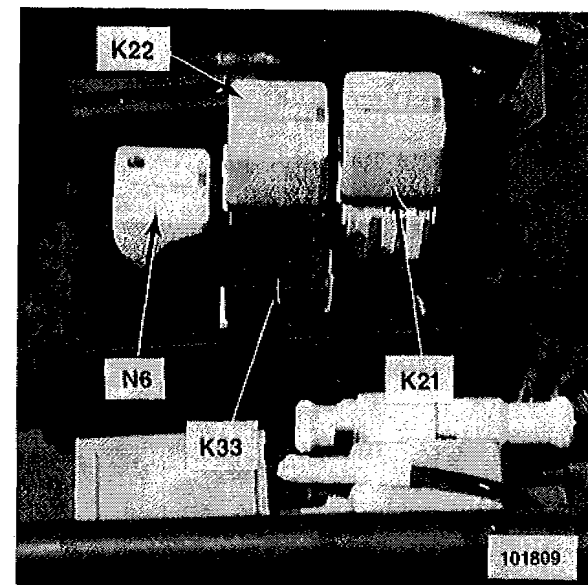

Figure 3- Top Of LH Front Wheel Well

- K21 Normal Speed Relay
- K22 High Speed Relay
- K33 Air Conditioning Motronic Relay
- N6 SRA Module

BMW **7** **COMPONENT LOCATION VIEWS**

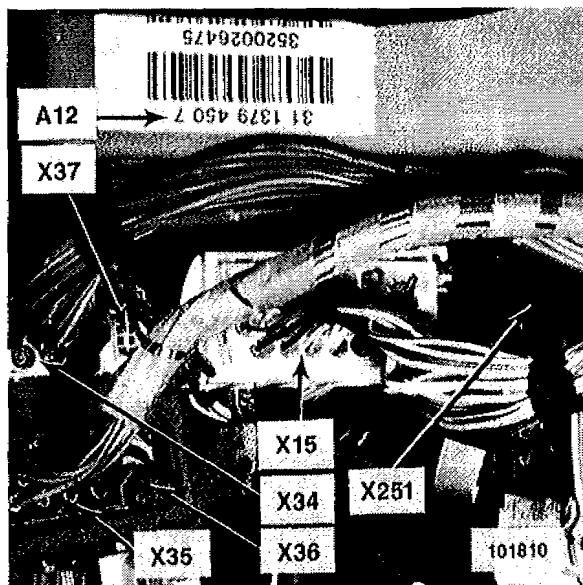

Figure 1- Below LH Side Of Dash

- A12 Diagnostic Module (SRS)**
- X15 Connector (30 pins) WS**
- X34 Connector (21 pins) WS**
- X35 Connector (21 pins) SW**
- X36 Connector (10 pins) SW**
- X37 Connector (10 pins) WS**
- X251 Connector (30 pins) SW**

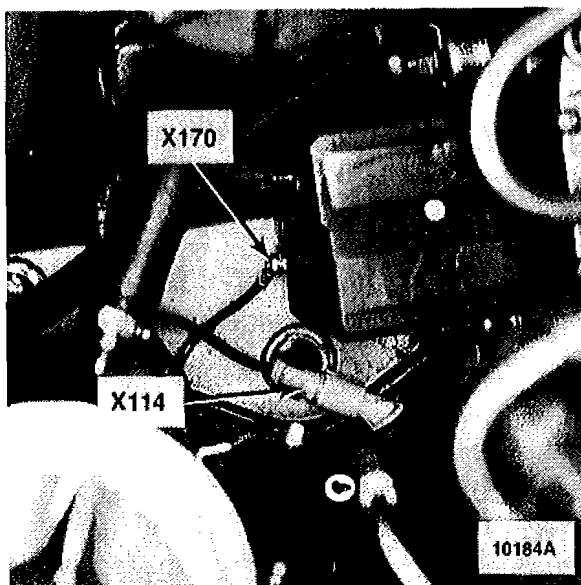

Figure 2- Lower LH Side Of Engine Compartment (735i/735iL Shown, 750iL Similar)

- X114 Connector (2 pins)**
- X170 Ground**

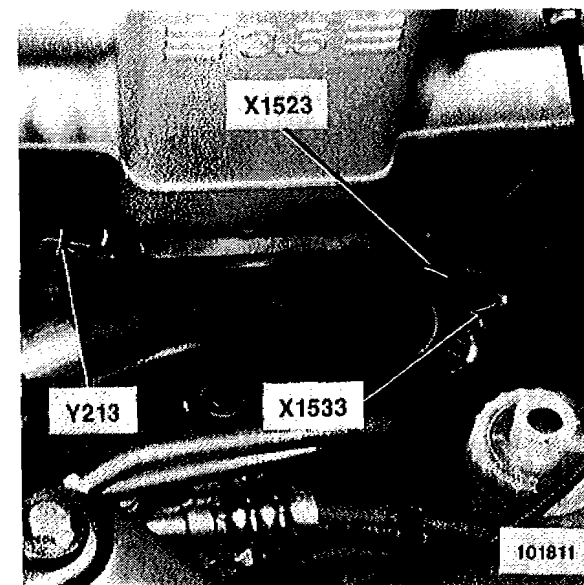

Figure 3- Lower LH Side Of Engine (735i/735iL)

- Y213 Evaporative Purge Valve**
- X1523 Connector (4 pins)**
- X1533 Connector (3 pins)**

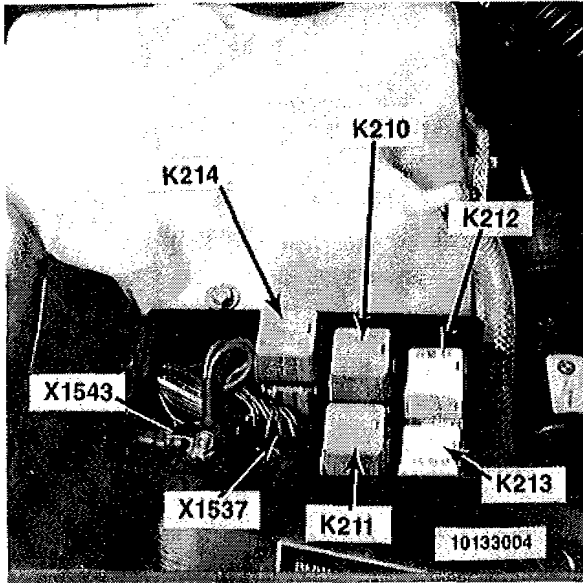

Figure 1- Above RH Front Wheel Well (750iL)

- K210 Fuel Pump Relay I (Cyl. 1-6)**
- K211 Fuel Pump Relay II (Cyl. 7-12)**
- K212 Main Relay I (Cyl. 1-6)**
- K213 Main Relay II (Cyl. 7-12)**
- K214 Oxygen Sensor Relay**
- X1537 Connector (8 pins)**
- X1543**

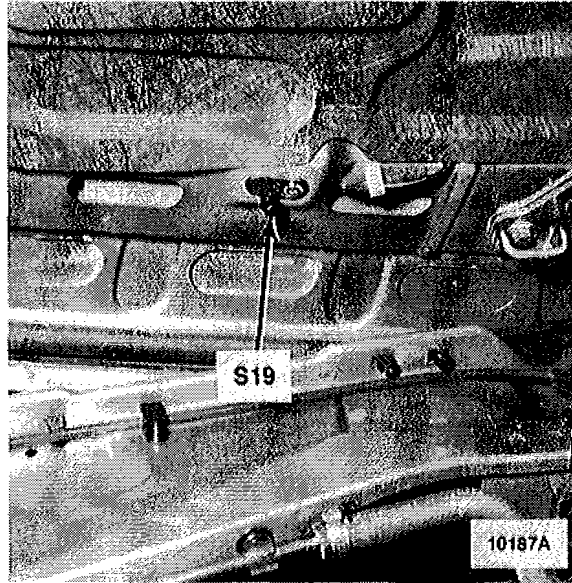

Figure 2- LH Front Of Engine Hood

- S19 Underhood Light Switch**

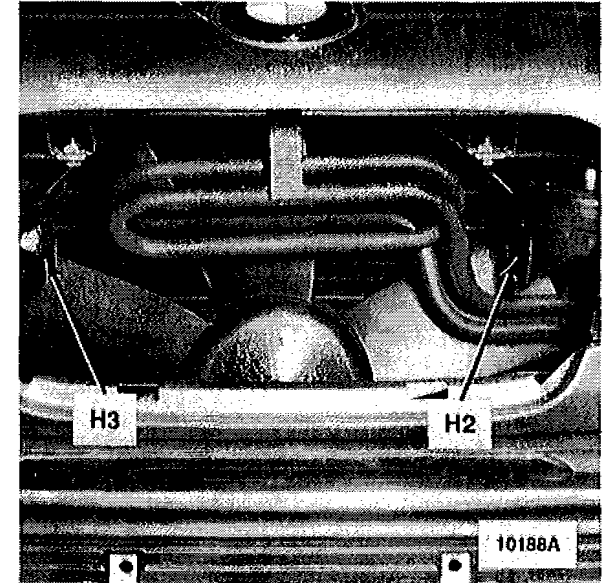

Figure 3- Front Of Car (Grille Removed)

- H2 Left Horn**
- H3 Right Horn**

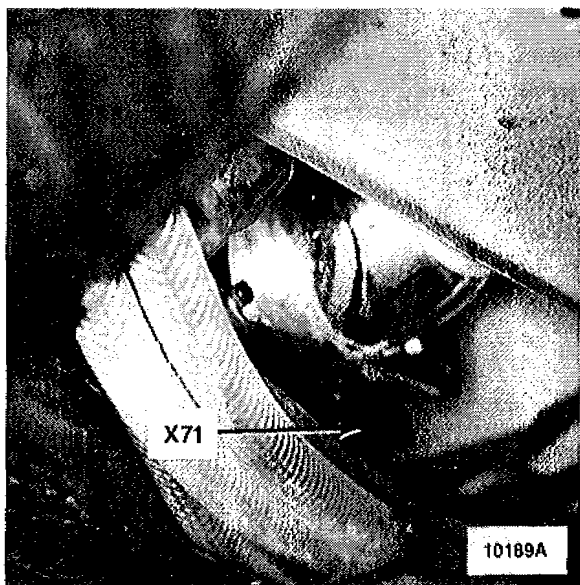

Figure 1- Behind LH Fog Light
X71 Connector (8 pins)

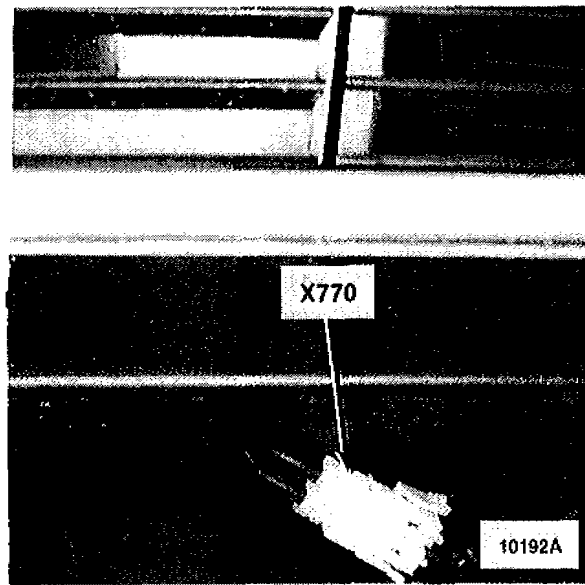

Figure 2- Below Front of Car
X770 Connector (2 pins)

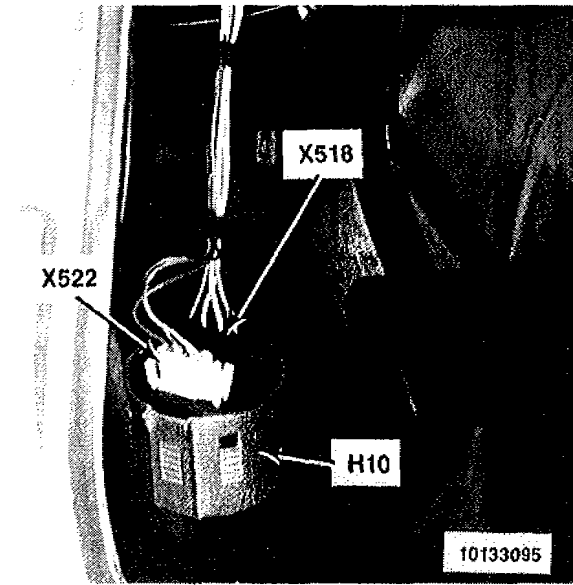

Figure 3- Below LH Side Of Dash
H10 Chime Module
X518 Connector (4 pins) SW
X522 Connector (3 pins) WS

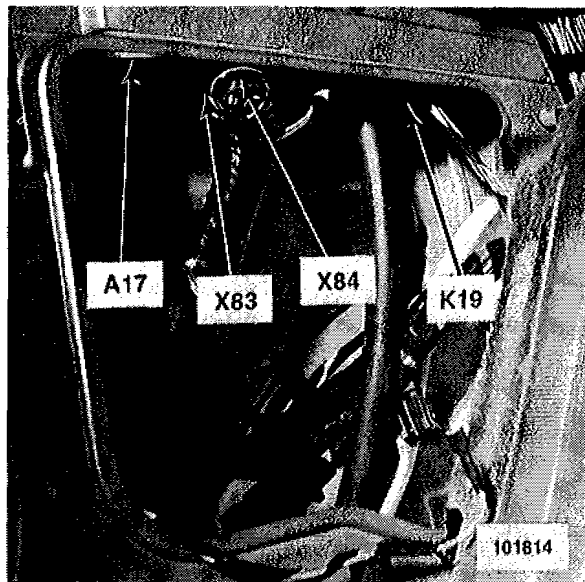

Figure 1- LH Side Of Driver's Footwell

- A17 Servotronic Control Unit**
- K19 Compressor Control Relay**
- X83 Connector (3 pins)**
- X84 Connector (3 pins)**



Figure 2- Below LH Side Of Dash

- X32 Connector (12 pins) WS**
- X33 Connector (12 pins) SW**
- X72 Connector (8 pins) WS**
- X295 Connector (8 pins) SW**
- X784 Connector (2 pins)**

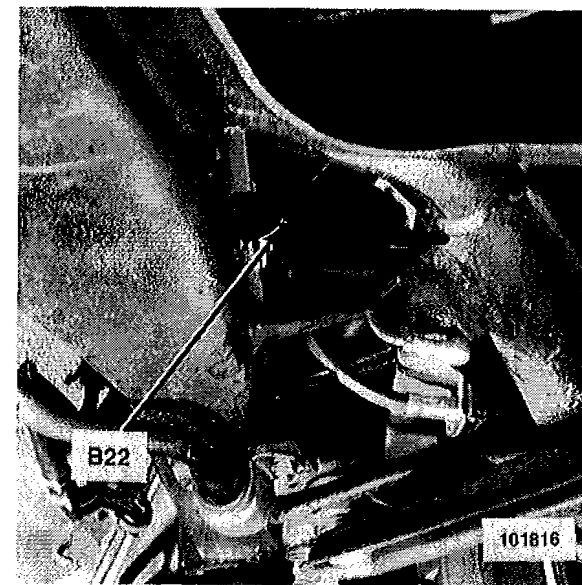

Figure 3- RH Side Of Differential

- B22 Wheel Camber Control Unit**

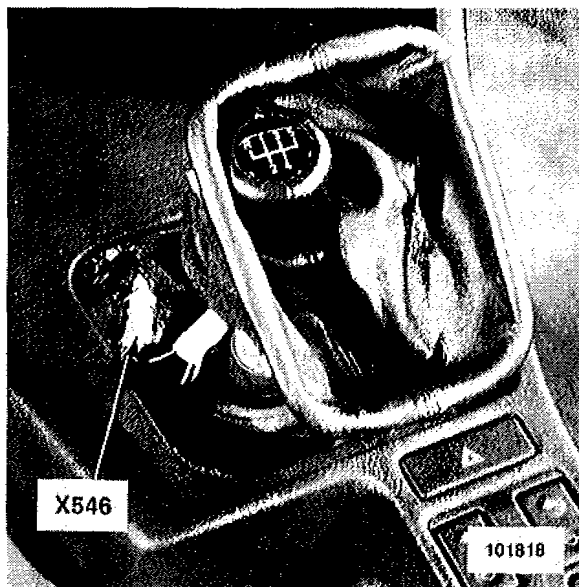

Figure 1- Center Of Console

X546 Connector (2 pins)

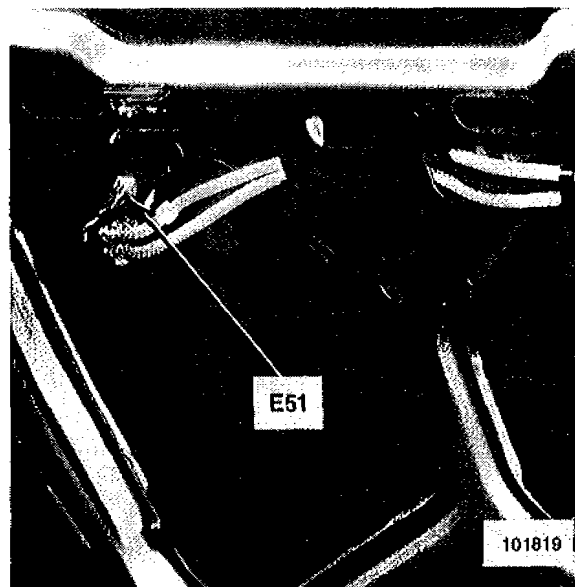

Figure 2- Engine Hood

E51 Left Washer Jet Heater

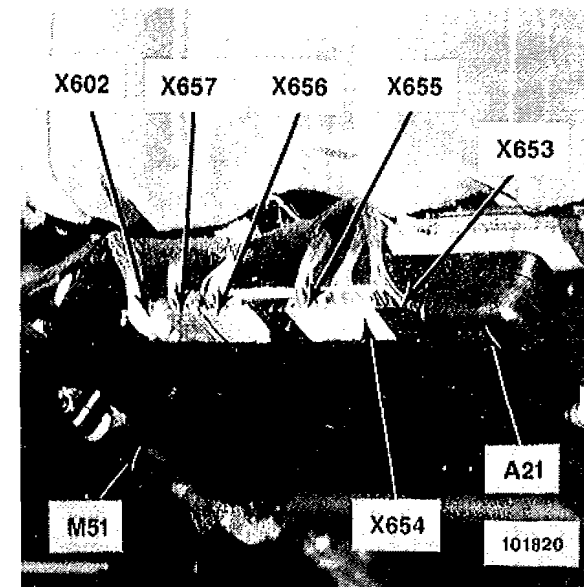

Figure 3- Under Driver's Seat

- A21 Memory Seat/Mirrors Control Unit
- M51 Driver's Seat Movement Motor
- X602 Connector (26 pins) WS
- X653 Connector (6 pins) SW
- X654 Connector (6 pins) WS
- X655 Connector (6 pins) BL
- X656 Connector (6 pins) GN
- X657 Connector (6 pins) BN

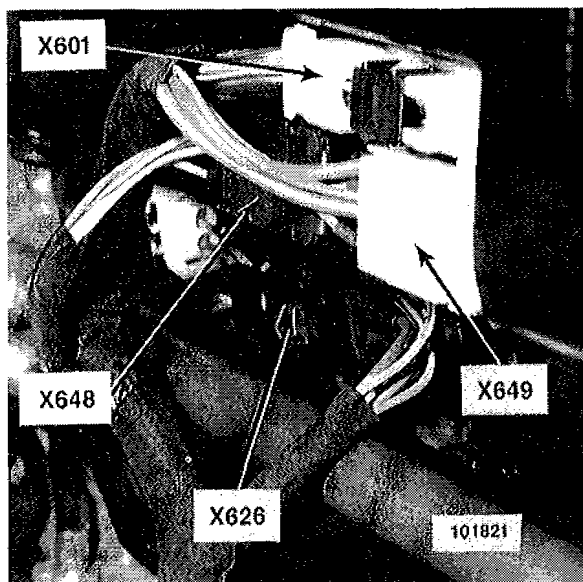

Figure 1- Under Driver's Seat

- X601** Connector (26 pins) GE
- X626** Connector (8 pins) SW
- X648** Connector (6 pins) SW
- X649** Connector (6 pins) WS

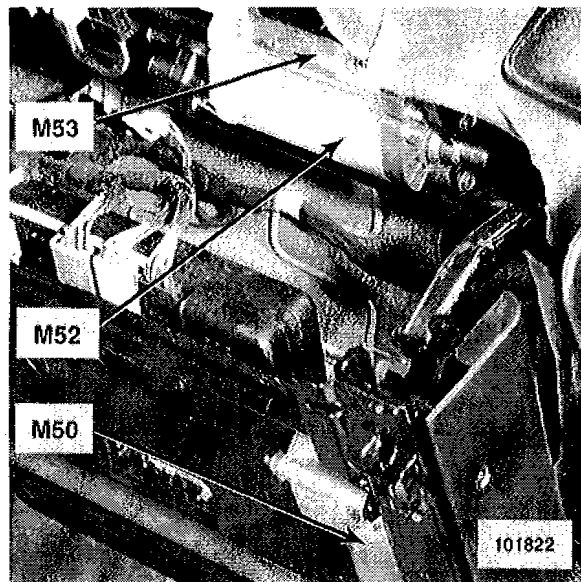

Figure 2- Under Driver's Seat (With Memory, Motor Position Without Memory Similar)

- M50** Driver's Seat Cushion Tilt Motor
- M52** Driver's Seat Height Motor
- M53** Driver's Seatback Recliner Motor

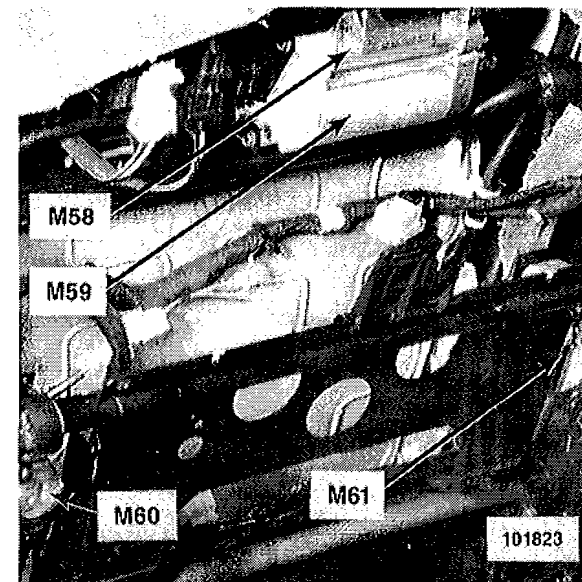

Figure 3- Under Passenger's Seat

- M58** Passenger's Seatback Recliner Motor
- M59** Passenger's Seat Height Motor
- M60** Passenger's Seat Movement Motor
- M61** Passenger's Seat Cushion Tilt Motor

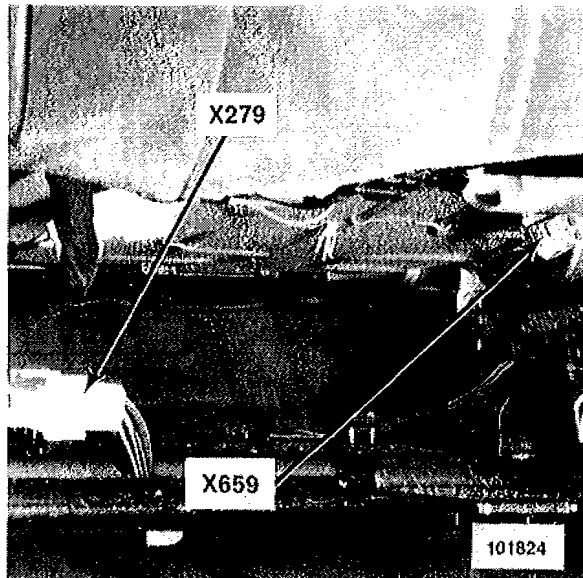

Figure 1- Under Passenger's Seat

- X279 Connector (12 pins)
- X659 Connector (6 pins)

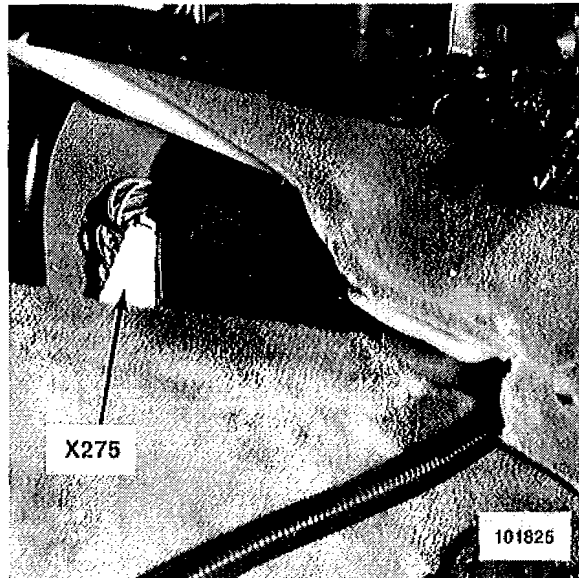

Figure 2- Under Driver's Seat (With Memory)

- X275 Connector (12 pins)

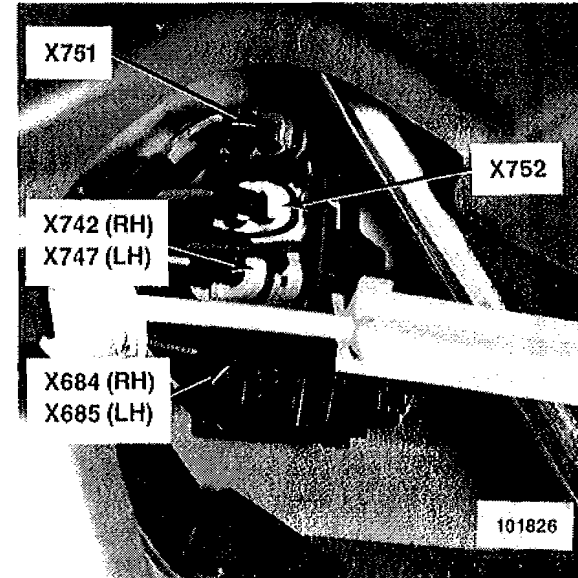

Figure 3- Driver's Door (Passenger's Door Similar)

- X684 Connector (3 pins) (Passenger's Door)
- X685 Connector (3 pins) SW
- X742 Connector (2 pins) (Passenger's Door)
- X747 Connector (2 pins) GE
- X751 Connector (2 pins) WS
- X752 Connector (2 pins) BL

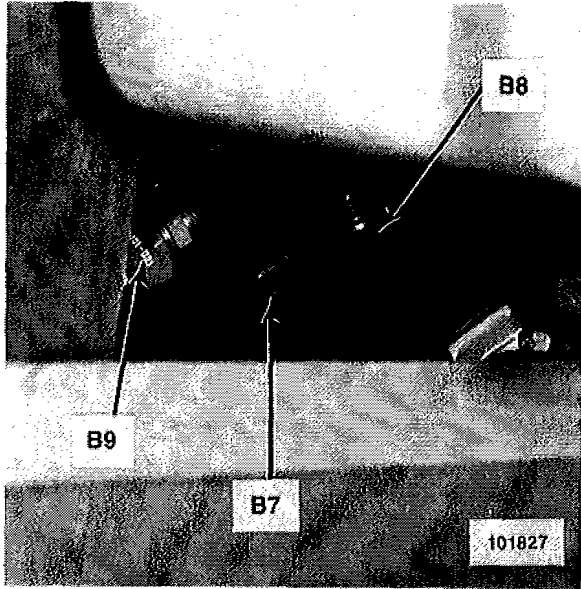

Figure 1- RH Front Of Engine Compartment

- B7 Low Pressure Switch**
- B8 High Pressure Switch**
- B9 Intermediate Pressure Switch**

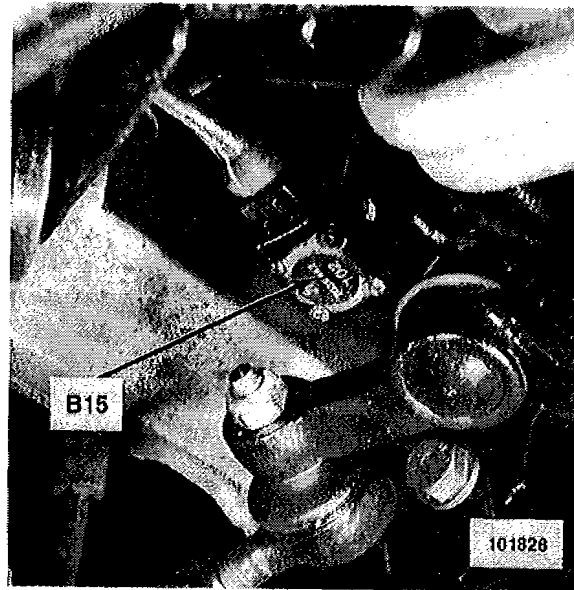

Figure 2- Behind LH Front Wheel

- B15 Electro-Hydraulic Converter (Servotronic)**

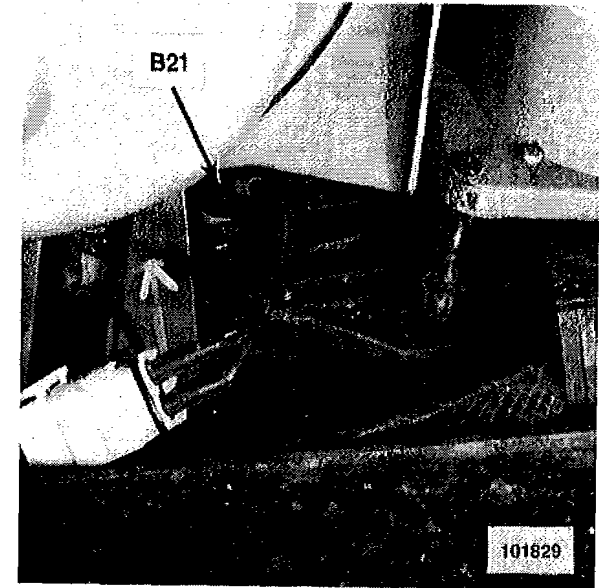

Figure 3- Lower RH Front

- B21 On-Board Computer Temperature Sensor**

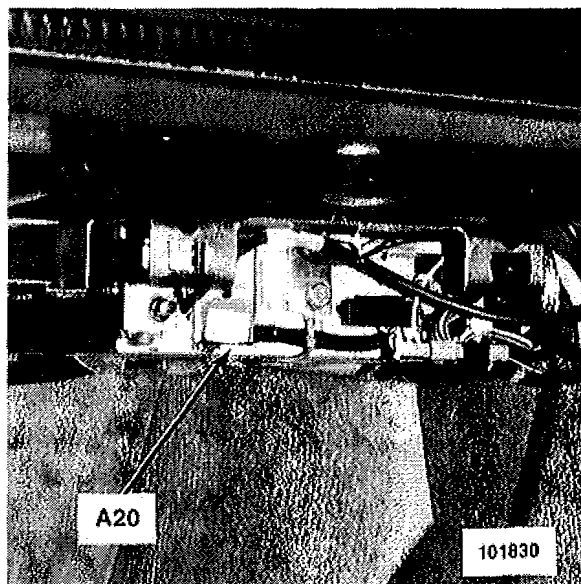

Figure 1- In Luggage Compartment

A20 Booster/Amplifier

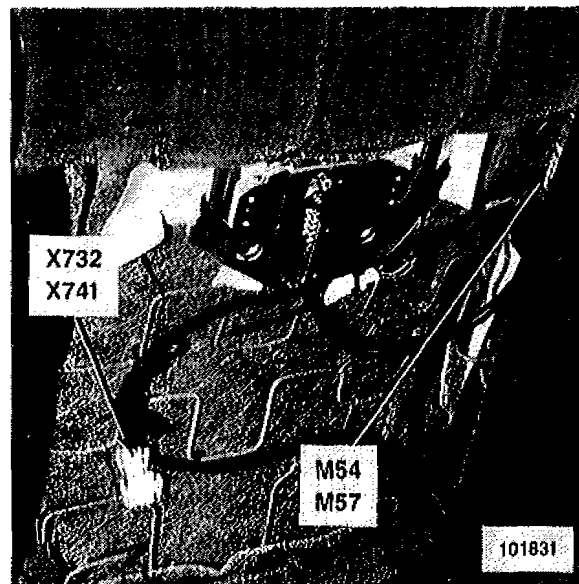

Figure 2- Back Of LH Front Seat

M54 Driver's Headrest Motor
M57 Passenger's Seat Headrest Motor
X732 Connector (2 pins)
X741 Connector (2 pins) Passenger's

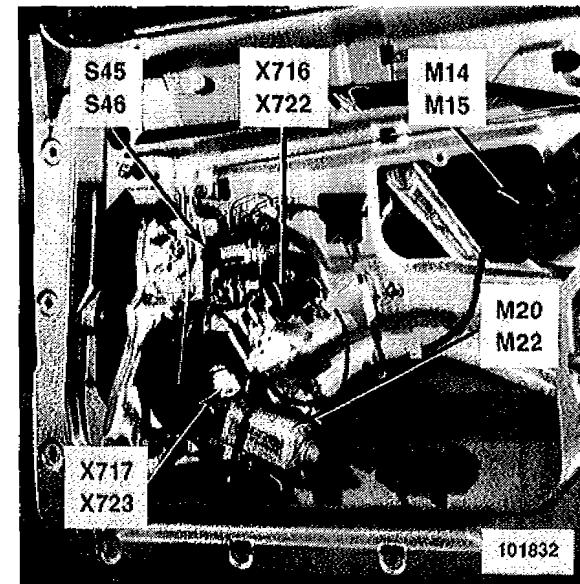

Figure 3- RH Rear Door (LH Rear Door Similar)

M14 Right Rear Door Lock Motor
M15 Left Rear Door Lock Motor
M20 Left Rear Window Motor
M22 Right Rear Window Motor
S45 Left Rear Window Limit Switch
S46 Right Rear Window Limit Switch
X716 Connector (2 pins)
X717 Connector (2 pins)
X722 Connector (2 pins)
X723 Connector (2 pins)

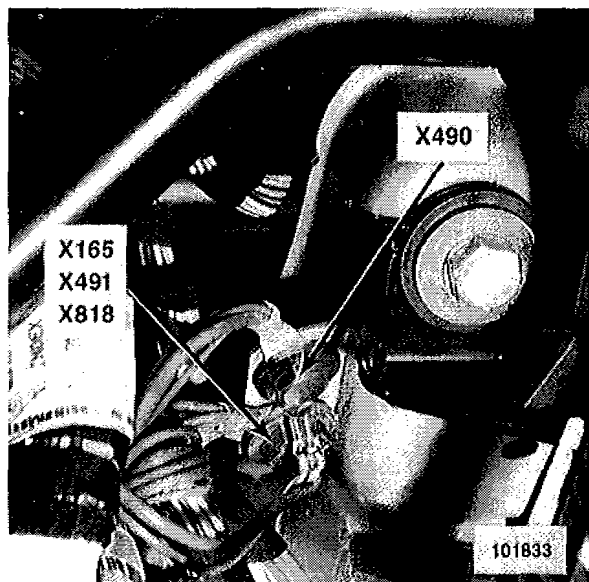

Figure 1- Below LH Side Of Dash

- X165 Ground
- X490 Ground
- X491 Ground
- X818 Ground

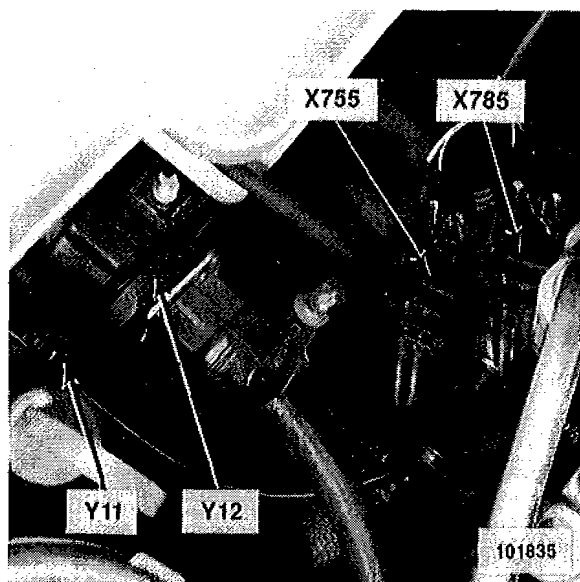

Figure 2- LH Side Of Engine (735i/735iL Shown, 750 Similar)

- Y11 Solenoid Valve 1
- Y12 Solenoid Valve 2
- X755 Connector (2 pins)
- X785 Connector (2 pins)

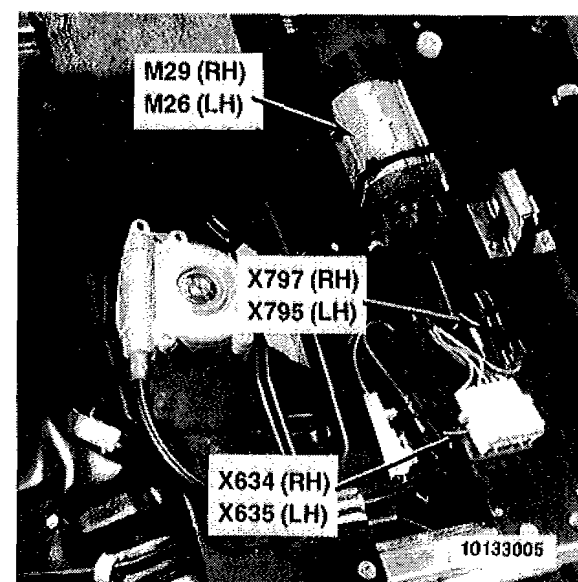

Figure 3- Underside Of Rear Seat (RH Side Shown With Power Seat Option, LH Side Similar)

- M26 Left Rear Seat Movement Motor
- M29 Right Rear Seat Movement Motor
- X634 Connector (6 pins, RH)
- X635 Connector (6 pins, LH)
- X797 Connector (2 pins, RH)
- X795 Connector (2 pins, LH)

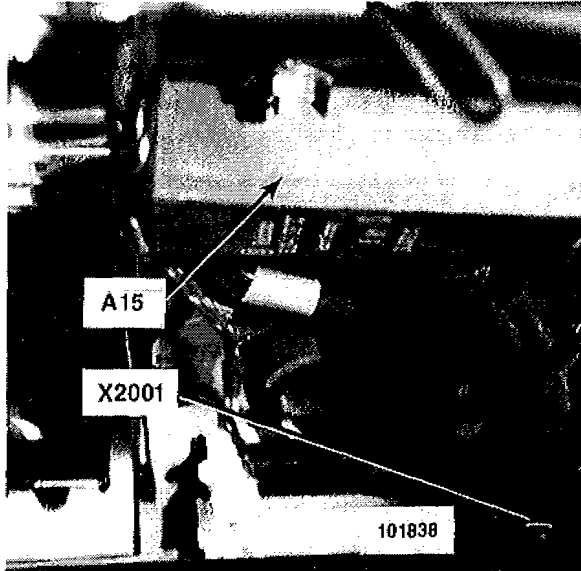

Figure 1- Behind Glove Box

A15 Park/Ventilation Relay Box
X2001 Connector (12 pins)



Figure 2- Under RH Side Of Rear Seat

X260 Connector (21 pins)

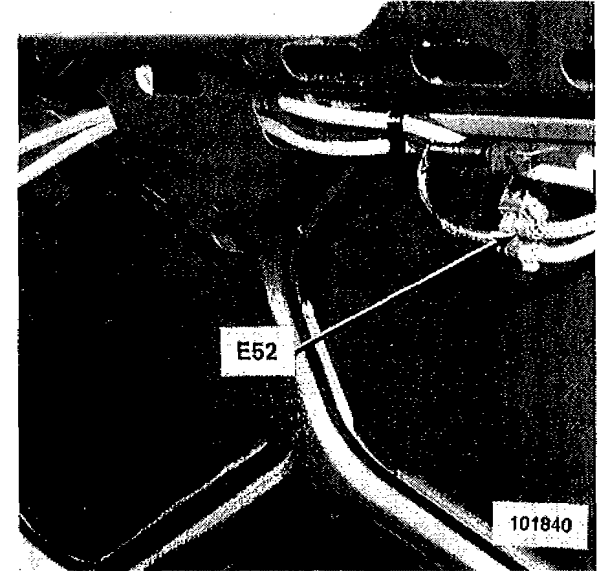

Figure 3- Engine Hood

E52 Right Washer Jet Heater

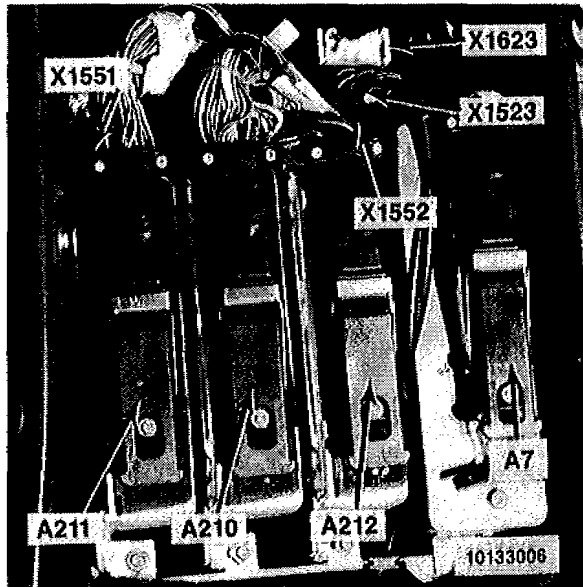

Figure 1- Rear Of Engine Compartment (750iL)

- A7** ABS Electronic Control Unit
- A210** EML Electronic Control Unit
- A211** Motronic Control Unit I (DME)
- A212** Motronic Control Unit II (DME)
- X1523** Connector (8 pins)
- X1551** Connector (2 pins)
- X1552** Connector (4 pins)
- X1623** Connector (8 pins)

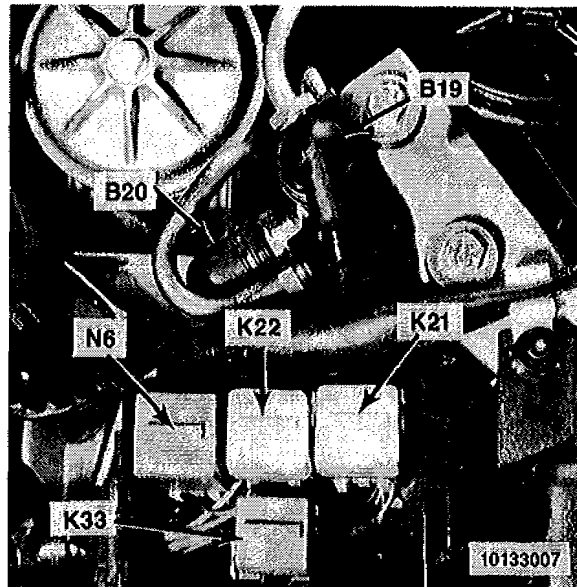

Figure 2- LH Front Of Engine Compartment (750iL Shown)

- B19** Brake Pressure Regulating Switch
- B20** Brake Pressure Switch
- K21** Normal Speed Relay
- K22** High Speed Relay
- K33** Air Conditioning Motronic Relay
- N6** Headlight/Front Fog Light Module (SRA)

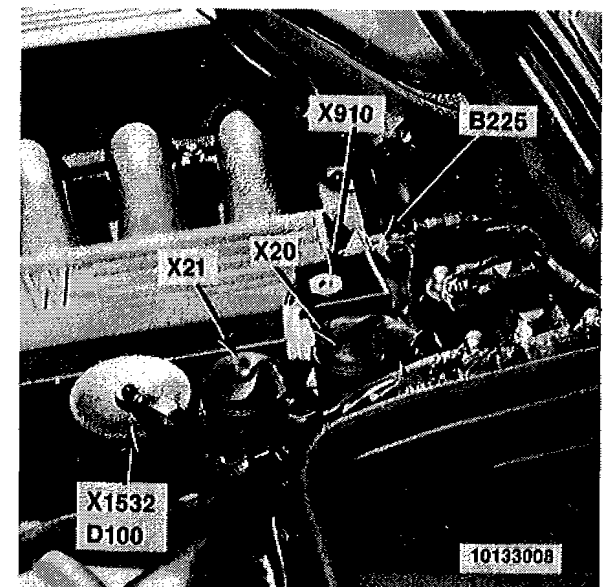

Figure 3- LH Rear Of Engine Compartment (750iL Shown)

- B225** Engine Intake Air Temperature Sensor II (Cyl 7-12)
- D100** Diagnostic Connector
- X20** Connector (20 pins)
- X21** Connector (20 pins)
- X910**
- X1532** Connector (20 pins)

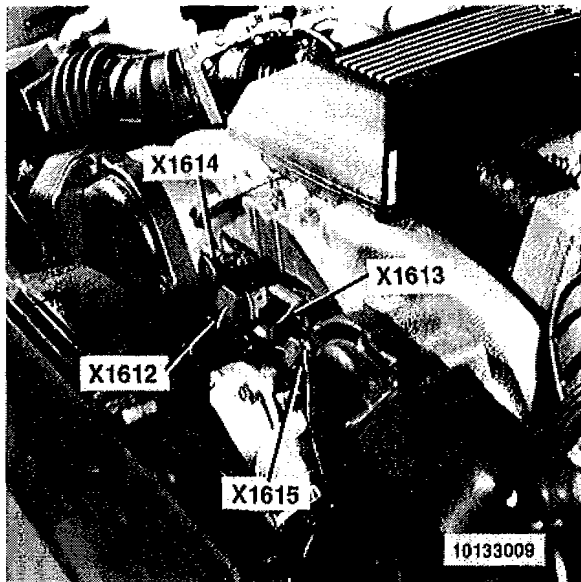

Figure 1- Front Of Engine (750iL)

- X1612 Connector (3 pins)
- X1613 Connector (3 pins)
- X1614 Connector (3 pins)
- X1615 Connector (3 pins)

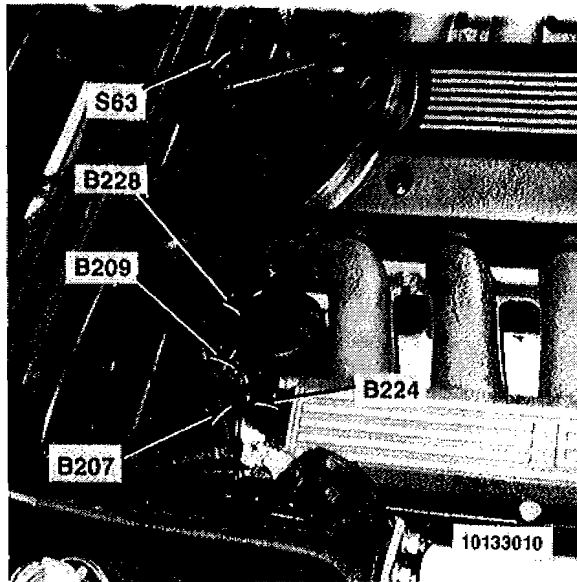

Figure 2- RH Rear Of Engine (750iL)

- B207 Coolant Temperature Sender
- B209 Water Temperature Sensor
- B224 Engine Intake Air Temperature Sensor I (Cyl 1-6)
- B228 Water Temperature Sensor (DME)
- S63 Coolant Level Switch

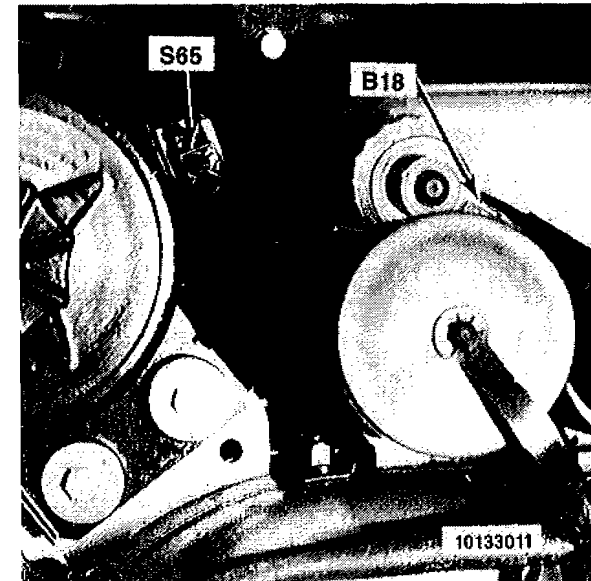

Figure 3- LH Side Of Engine Compartment Near Shock Tower (750iL)

- B18 Brake Fluid Level Switch
- S65 Power Steering Fluid Level Switch

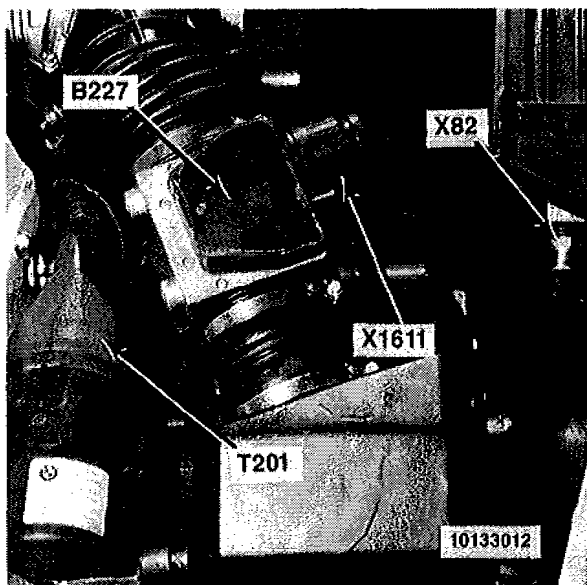

Figure 1- RH Front Of Engine Compartment (750iL)

- B227 Air Mass Meter II (Cyl 7-12)
- T201 Ignition Coil I (Cyl 1-6)
- X82 Connector (3 pins)
- X1611 Connector (6 pins)

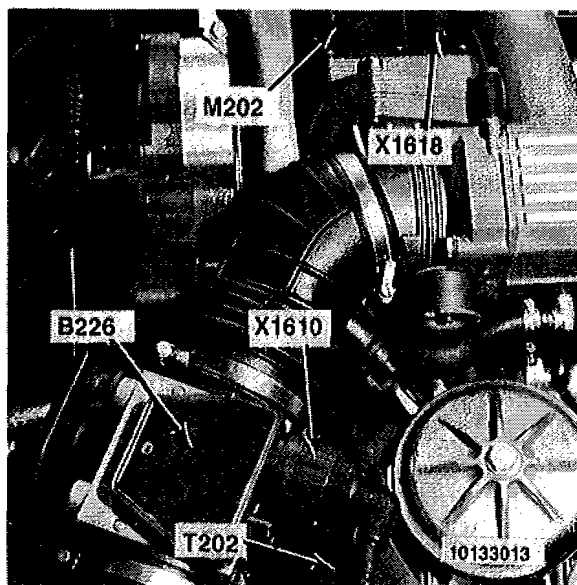

Figure 2- LH Front Of Engine Compartment (750iL)

- B226 Air Mass Meter I (Cyl 1-6)
- M202 Throttle Position Motor (Cyl 1-6)
- T202 Ignition Coil II (Cyl 7-12)
- X1610 Connector (6 pins)
- X1618 Connector (8 pins)

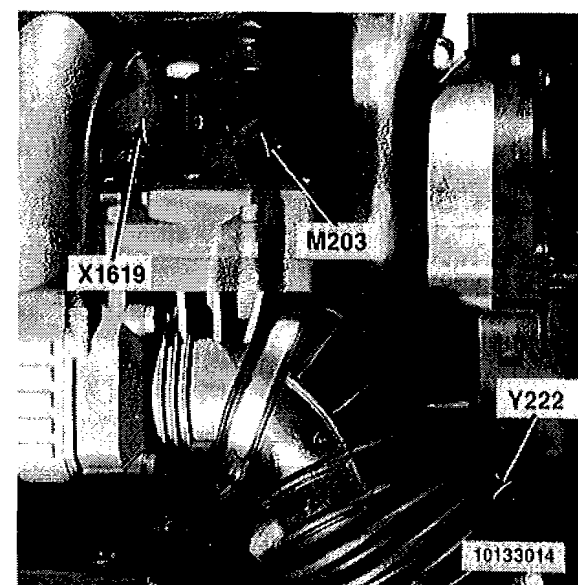

Figure 3- RH Front Of Engine (750iL)

- M203 Throttle Position Motor II (Cyl 7-12)
- X1619 Connector (8 pins)
- Y222 Evaporative Purge Valve II (Cyl 7-12)



COMPONENT LOCATION VIEWS

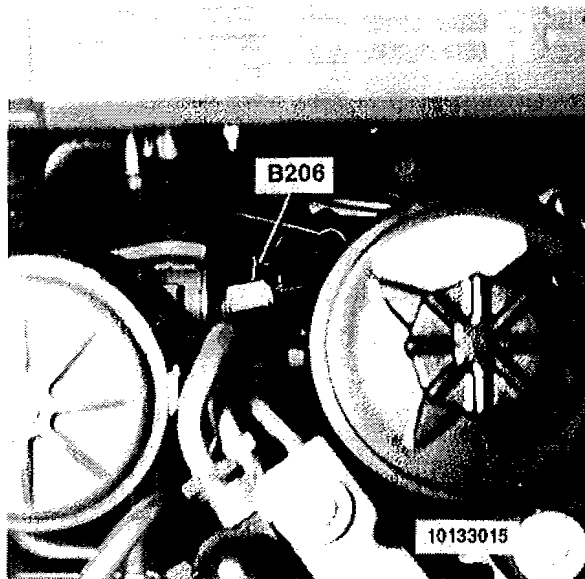

Figure 1- LH Side Of Engine Near The Wheel Well (750iL)

B206 Oil Pressure Switch

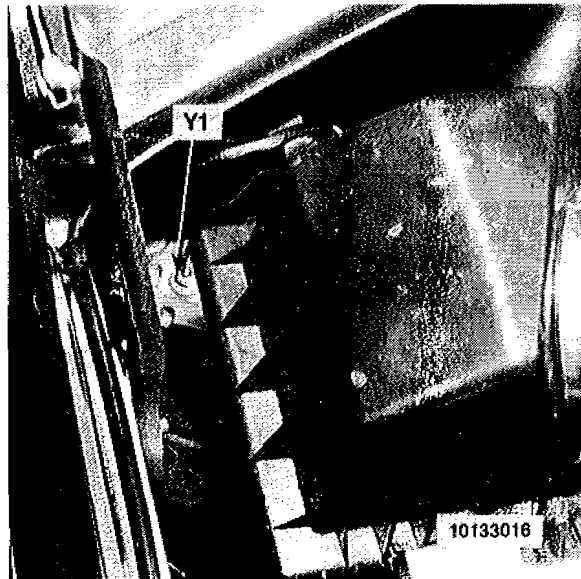

Figure 2- LH Front Of Engine Compartment (750iL)

Y1 ABS Hydraulic Unit

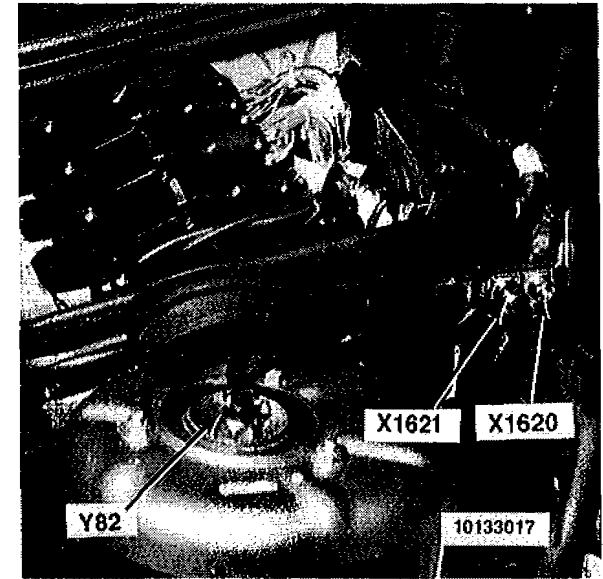

Figure 3- Top Of RH Front Wheel Well (750iL)

X1620 Ground

X1621 Ground

Y82 EDC Right Front Shock Absorber



COMPONENT LOCATION VIEWS

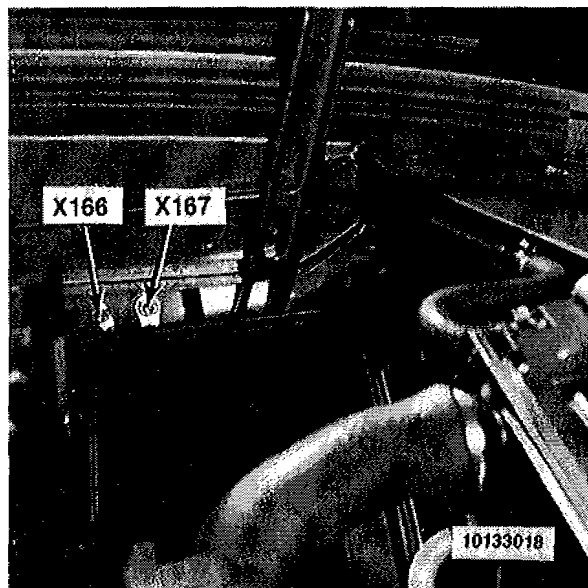

Figure 1- LH Front Of Engine Compartment (Air Filter Removed) (750iL)

X166 Ground
X167 Ground

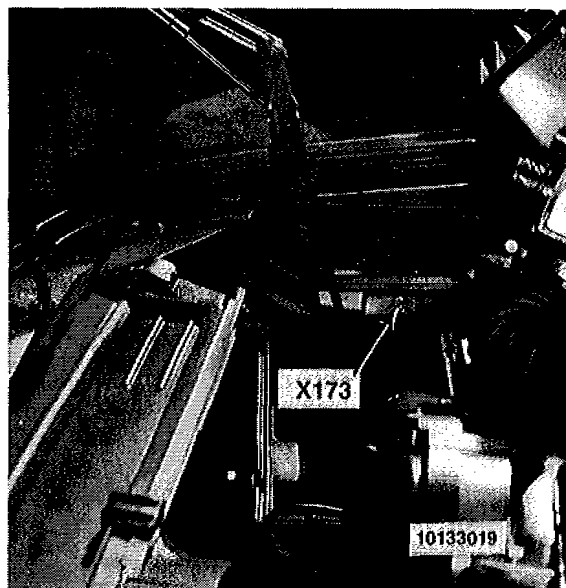

Figure 2- RH Front Of Engine Compartment (Air Filter Removed) (750iL)

X173 Ground

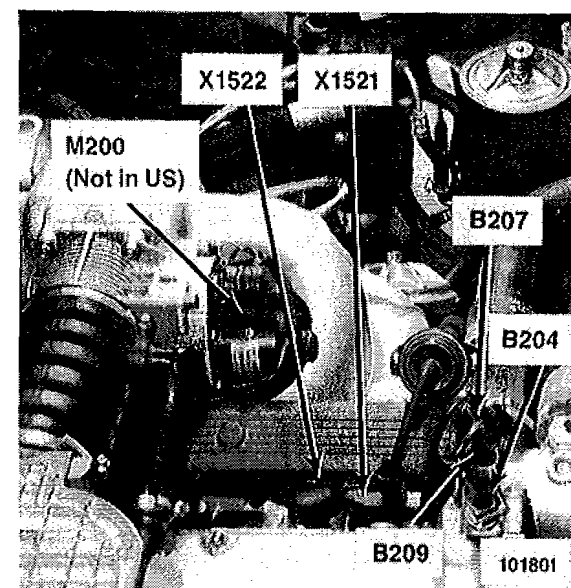

Figure 3- RH Front Of Engine (735i/735iL)

B204 Coolant Temperature Sensor
B207 Coolant Temperature Sender
B209 Water Temperature Sensor
X1521 Connector (3 pins)
X1522 Connector (3 pins)



SPLICE LOCATION VIEWS

SPLICE LOCATION INDEX

This index contains all the splices in the car, what harness each one is in, and the page that the splices appear on. The drawings after the index show how the harness is routed through the car and where the splices are located on the harness.

Index-Splice Locations - E32 - 735i, 735iL, 750iL

SPLICE	HARNESS	PAGE NUMBER	SPLICE	HARNESS	PAGE NUMBER
X145	FRONT	8000-02	X584	INSTRUMENT MAN TRANS	8000-05
X181-X193	FRONT	8000-02	X597	INSTRUMENT AUTO TRANS	8000-06
X195-X206	FRONT	8000-02	X597	INSTRUMENT MAN TRANS	8000-05
X208-X210	FRONT	8000-02	X824-X830	RADIO/HIFI/CD	NOT SHOWN
X212-X215	FRONT	8000-02	X831	SUNROOF	NOT SHOWN
X217	FRONT	8000-02	X832	TRAILER ADAPT	NOT SHOWN
X222-X228	FRONT	8000-02	X833	TRUNK	NOT SHOWN
X241-X246	FRONT	8000-02	X834	LH REAR DOOR	NOT SHOWN
X430-X434	REAR	8000-07	X835	RH REAR DOOR	NOT SHOWN
X436-X439	REAR	8000-07	X836	DRIVER SEAT	NOT SHOWN
X441-X451	REAR	8000-07	X837-X838	REAR SEAT HEATING	NOT SHOWN
X452-X469	REAR	8000-07	X839-X843	DRIVER SEAT	NOT SHOWN
X470	REAR	8000-07	X844-X847	PASSENGER SEAT	NOT SHOWN
X472-X473	REAR	8000-07	X848-X851	DRIVER DOOR	NOT SHOWN
X475	REAR	8000-07	X852-X860	IHKA	8000-08
X476-X477	REAR	8000-07	X863	PASSENGER DOOR	NOT SHOWN
X479-X489	REAR	8000-07	X866-X868	REAR SEAT HEATING	NOT SHOWN
X561-X567	INSTRUMENT AUTO TRANS	8000-06	X1008	FRONT	8000-02
X568-X570	INSTRUMENT AUTO TRANS	8000-06	X1009	FRONT	8000-02
X568-X570	INSTRUMENT MAN TRANS	8000-05	X1022	FRONT	8000-02
X573	INSTRUMENT AUTO TRANS	8000-06	X1023	FRONT	8000-02
X574-X577	INSTRUMENT AUTO TRANS	8000-06	X1323	REAR	8000-07
X574-X577	INSTRUMENT MAN TRANS	8000-05	X1324	REAR	8000-07
X579-X582	INSTRUMENT AUTO TRANS	8000-06	X1359-X1362	REAR	8000-04
X579-X582	INSTRUMENT MAN TRANS	8000-05	X1801-X1802	M70 ENGINE	8000-04
X584	INSTRUMENT AUTO TRANS	8000-06	X1804-X1807	M70 ENGINE	8000-04



SPLICE LOCATION VIEWS

SPLICE LOCATION INDEX

SPLICE	HARNESS	PAGE NUMBER
X1810-X1812	M70 ENGINE	8000-04
X1818-X1824	M70 ENGINE	8000-04
X1826-X1827	M70 ENGINE	8000-04
X1831	M70 ENGINE	8000-04
X1834-X1837	M70 ENGINE	8000-04
X1840-X1841	M70 ENGINE	8000-04
X1843-X1844	M70 ENGINE	8000-04
X1843-X1844	M70 ENGINE	8000-04
X1850	M70 ENGINE	8000-04
X1861	M70 ENGINE	8000-04
X1865	M70 ENGINE	8000-04
X1870-X1875	M70 ENGINE	8000-04
X1902-X1903	M30 ENGINE	8000-03
X1906-X1908	M30 ENGINE	8000-03
X1913	M30 ENGINE	8000-03
X1914	M30 ENGINE	8000-03
X1920-X1921	M30 ENGINE	8000-03
X1926	M30 ENGINE	8000-03
X1931	M30 ENGINE	8000-03
X1933	M30 ENGINE	8000-03
X1935-X1936	M30 ENGINE	8000-03
X1939	M30 ENGINE	8000-03
X1951	M30 ENGINE	8000-03
X1954-X1955	M30 ENGINE	8000-03
X2972	INSTRUMENT AUTOTRANS	8000-06
X3170	FRONT	8000-02
X13023	REAR	8000-07
X13024	REAR	8000-07
X19507	FRONT	8000-02
X19508	FRONT	8000-02



SPLICE LOCATION VIEWS

FRONT HARNESS

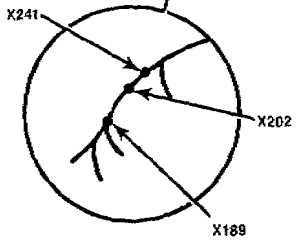
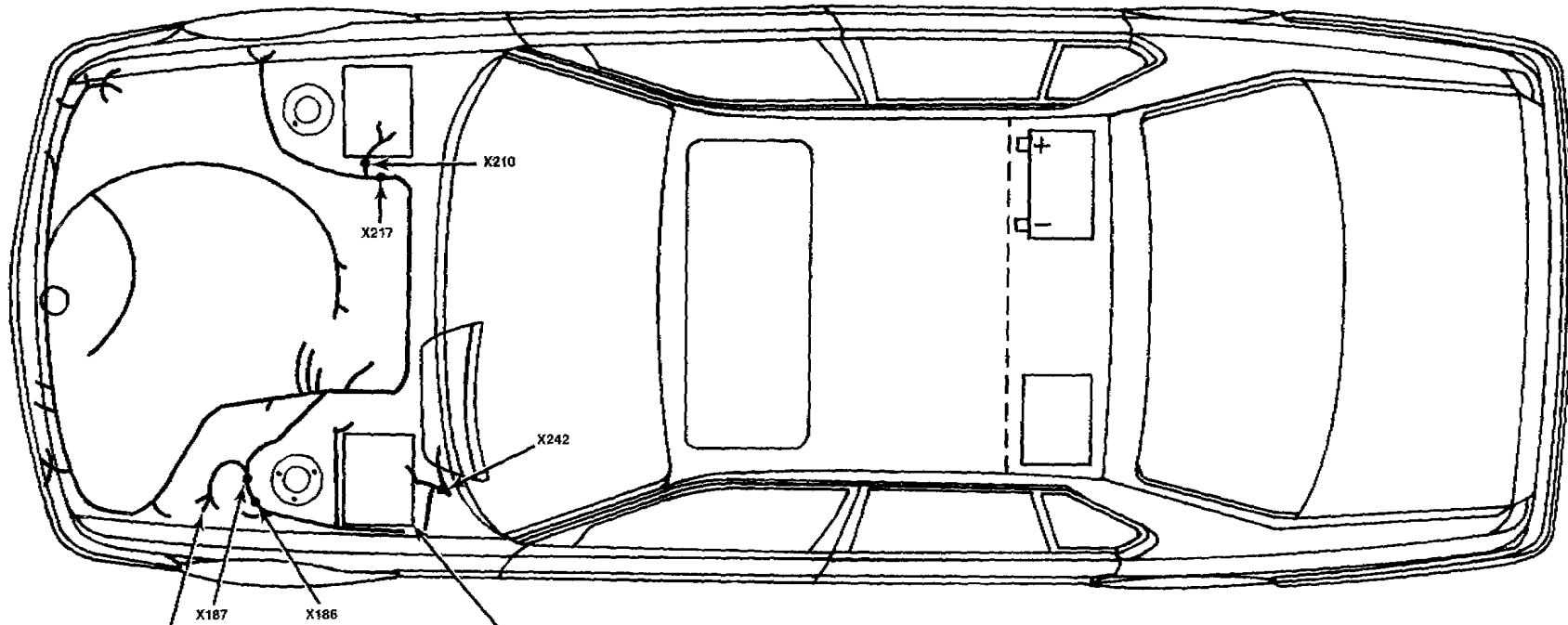

X145	X214	X195
X181	X228 •	X1009
X1008 •	X244	X210
X182	X196	X222 •
X183	X227	X212
X184	X225	X224
X186	X204	X213
X190	X205	X1023
X188	X199	X223 •
X191	X206	X209 •
X192	X226	X208
X193	X203	X243
X246	X19507	X1022
X245		X200
X3178		X201
		X197
		X215
		X196
		X19508



SPLICE LOCATION VIEWS M30 ENGINE HARNESS

735i, 735iL

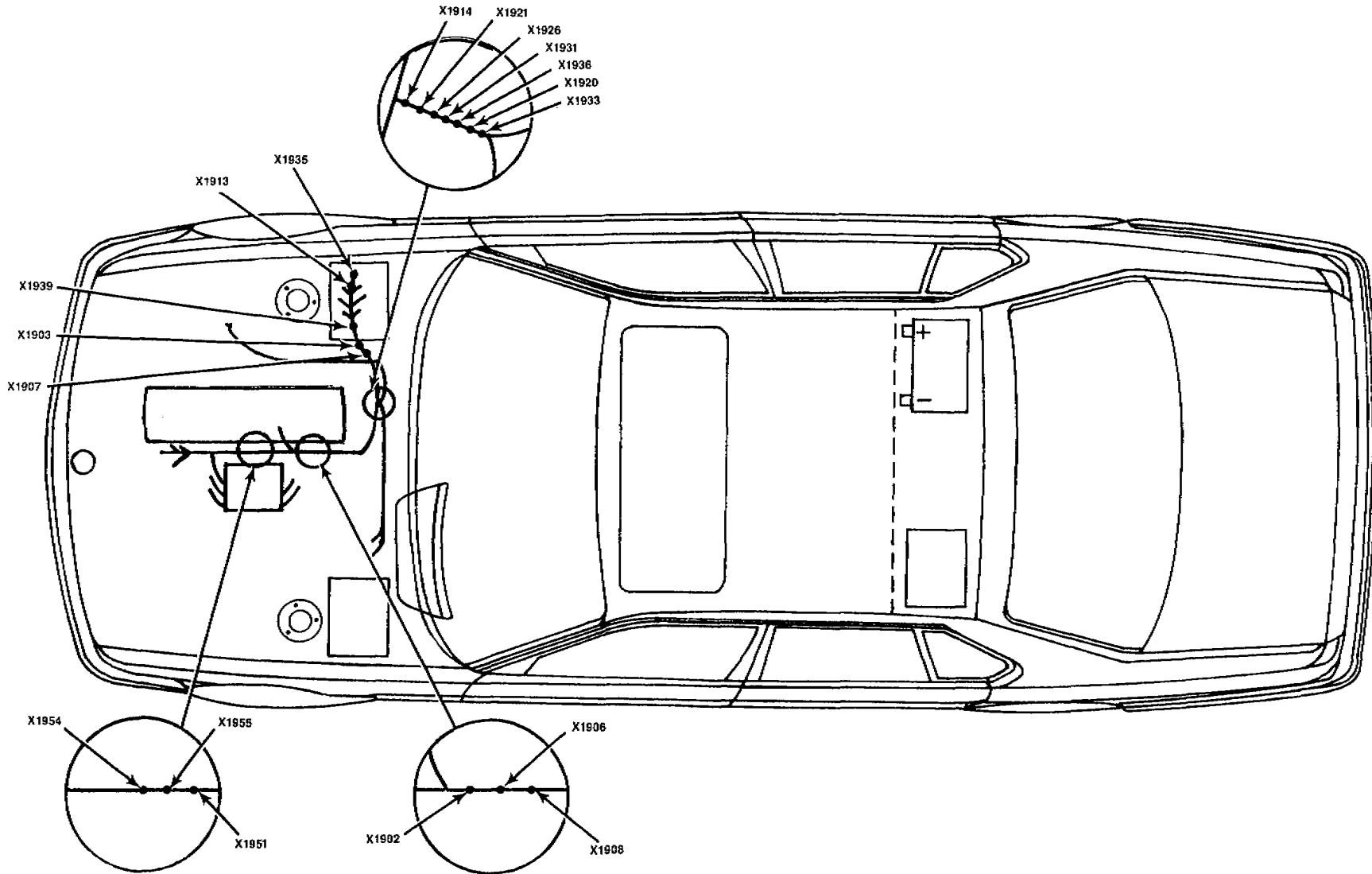



SPLICE LOCATION VIEWS M70 ENGINE HARNESS

750iL

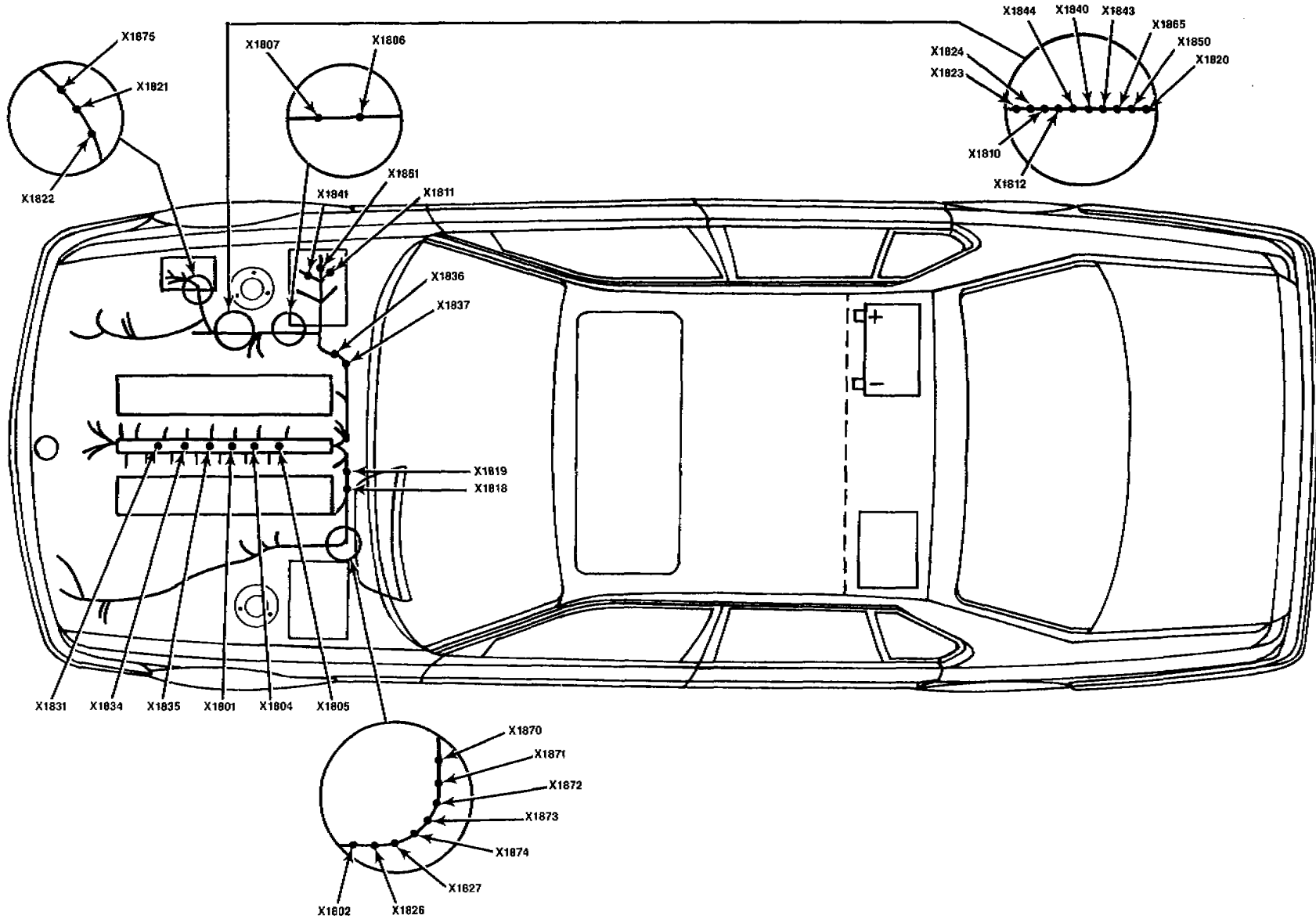



SPLICE LOCATION VIEWS INSTRUMENT HARNESS

MANUAL TRANSMISSION

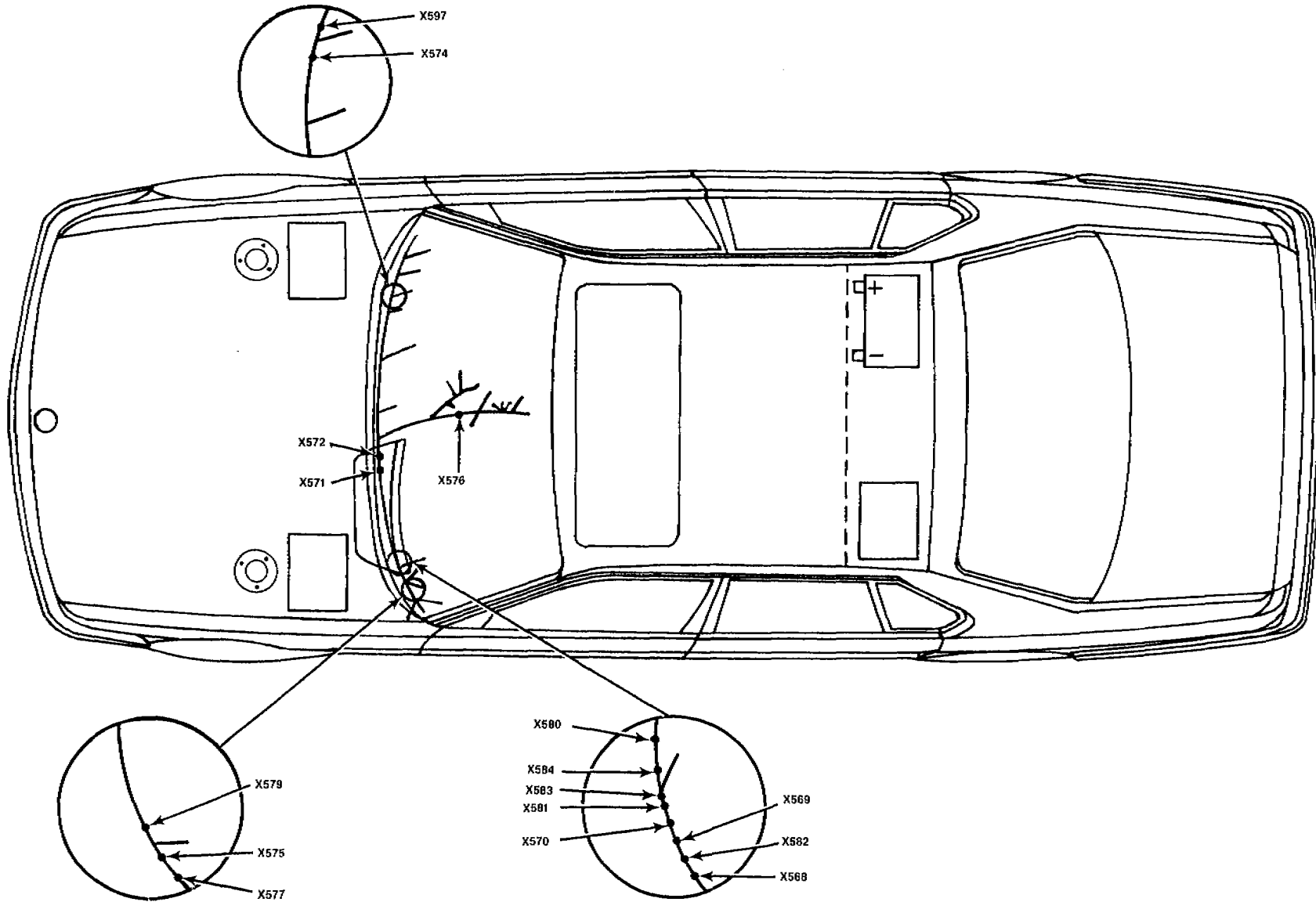



SPLICE LOCATION VIEWS INSTRUMENT HARNESS

AUTOMATIC TRANSMISSION

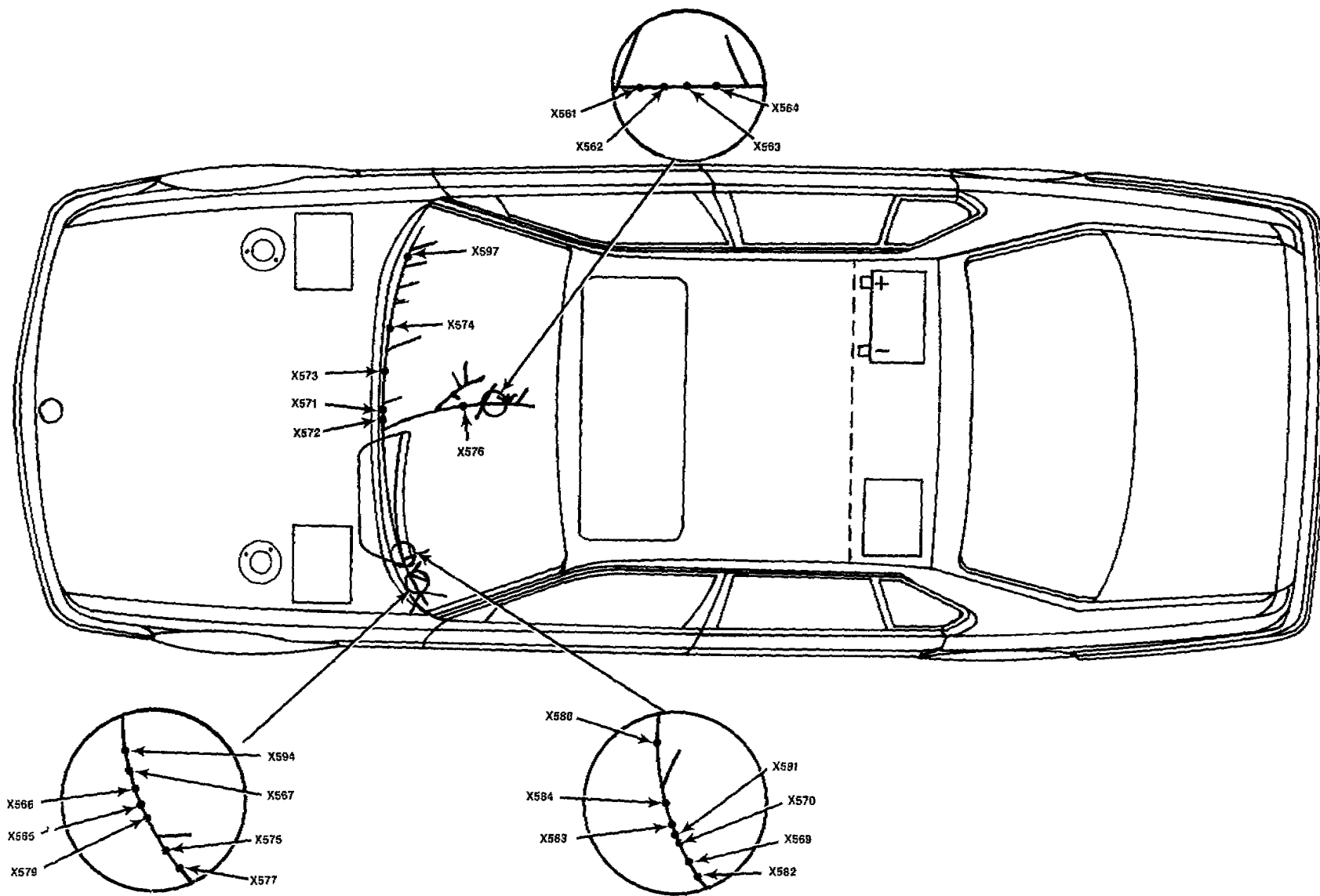



SPLICE LOCATION VIEWS
REAR HARNESS

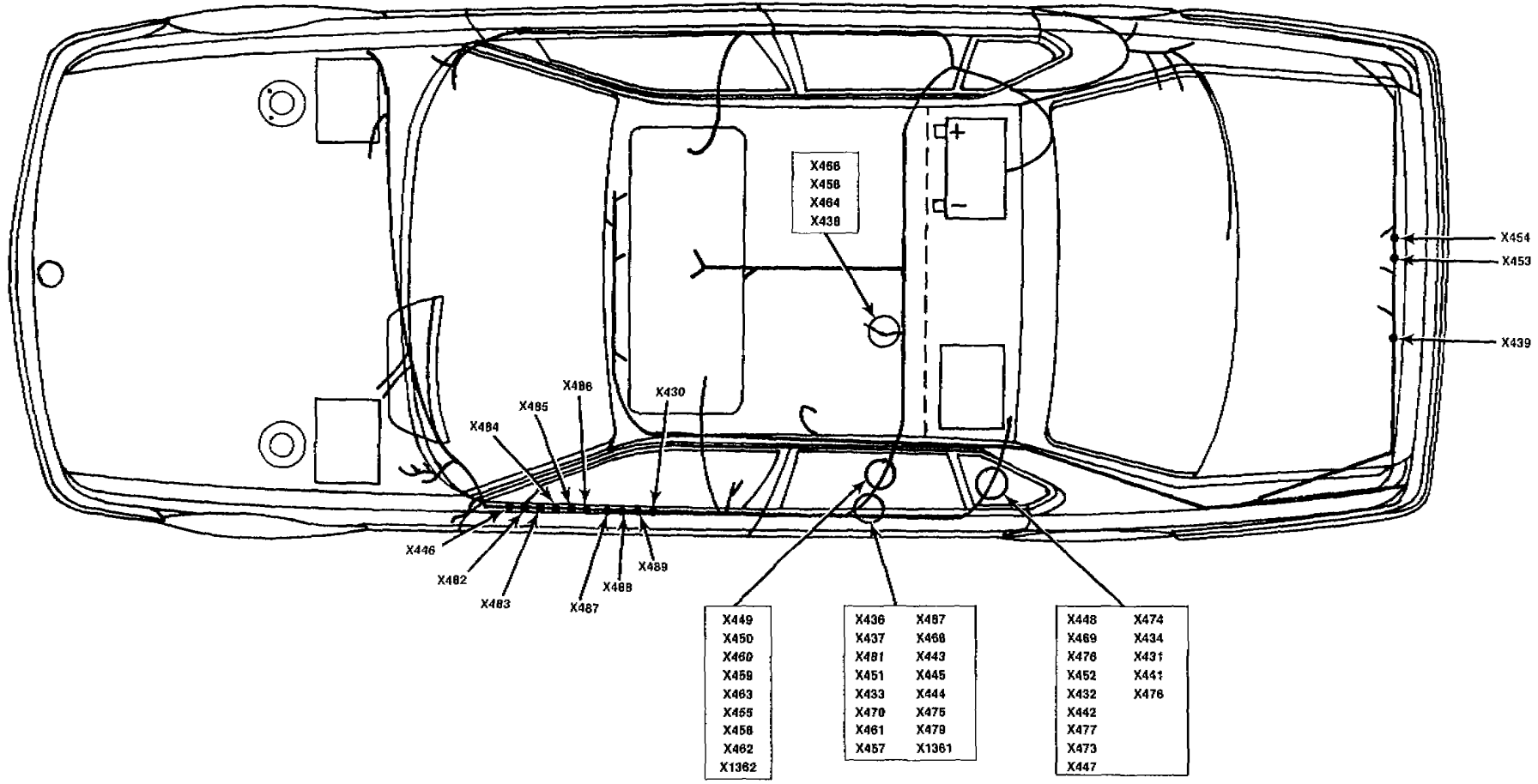



SPLICE LOCATION VIEWS

IHR/IHKA HARNESS

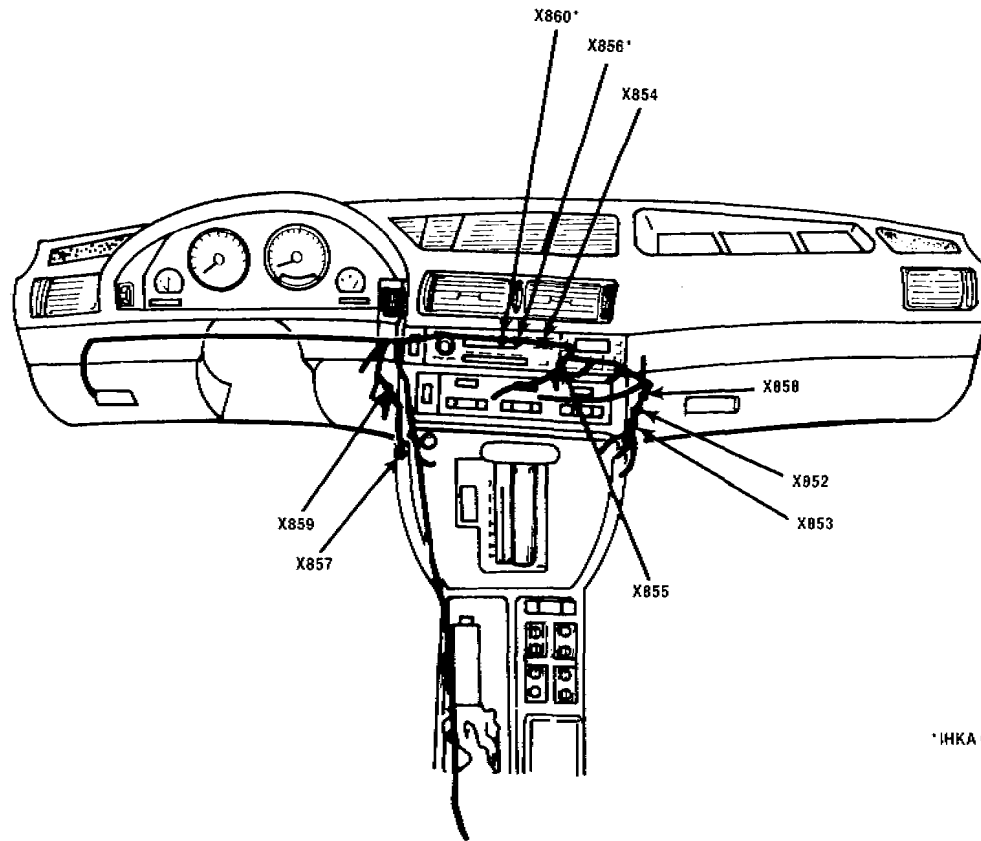

*IHKA ONLY



CONNECTOR VIEWS

B550001.00

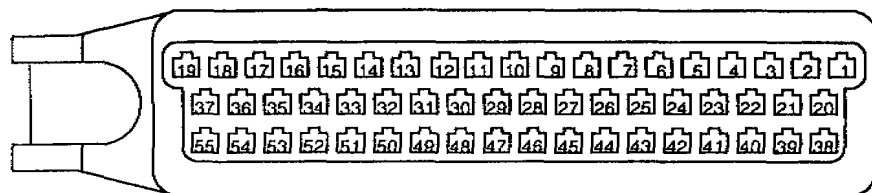

X7 NA

B350001.00

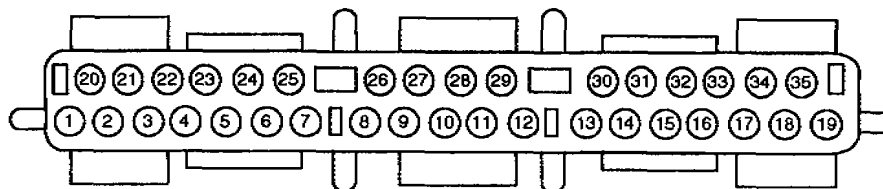

X12 SW

B350002.00

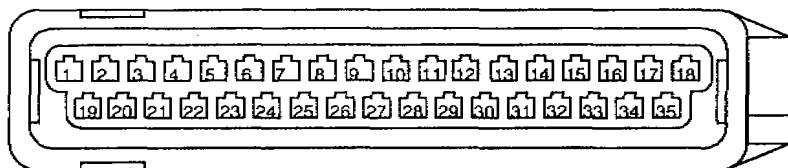

X11 NA

B300001.00

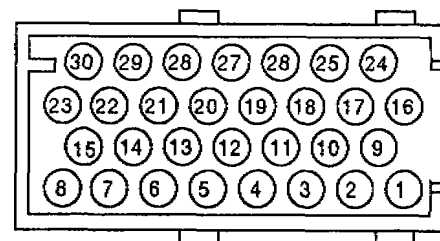

X13 BL

X14 SW

X15 WS



CONNECTOR VIEWS

B260002.00

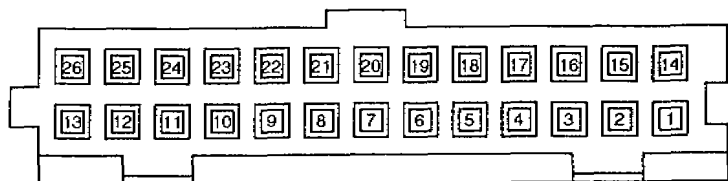

- X16 GE
- X18 BL
- X19 GN
- X22 BL

B200002.00

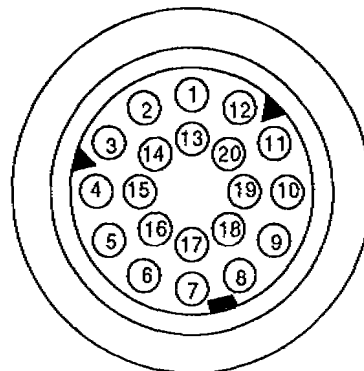

- X20 SW

B210001.00

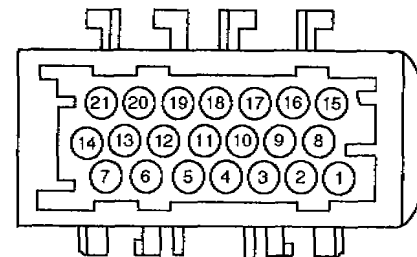

- X23 WS
- X24 SW

B240001.00

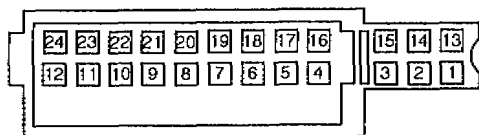

- X17 BR

B200004.00

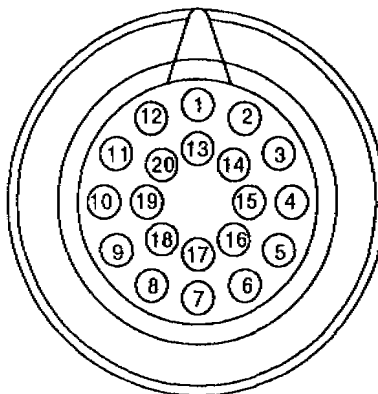

- X21 SW

B120013.00

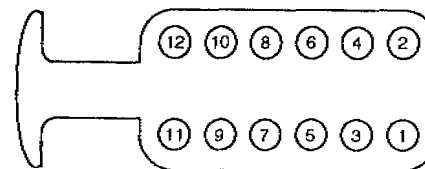

- X31 SW



CONNECTOR VIEWS

B120010.00

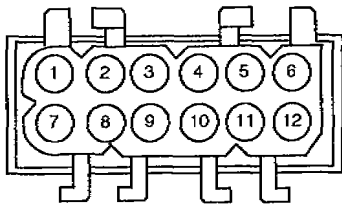

X32 WS

B210001.00

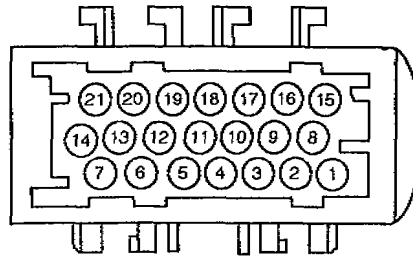

X34 WS

B090001.00

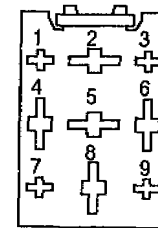

- | | |
|---------------|---------------|
| <u>X48</u> WS | <u>X57</u> SW |
| <u>X49</u> WS | <u>X58</u> WS |
| <u>X50</u> WS | <u>X59</u> SW |
| <u>X51</u> SW | <u>X60</u> SW |
| <u>X52</u> WS | <u>X61</u> SW |
| <u>X53</u> WS | <u>X62</u> WS |
| <u>X54</u> SW | <u>X63</u> WS |
| <u>X55</u> WS | <u>X64</u> SW |
| <u>X56</u> WS | <u>X65</u> BR |

B120004.01

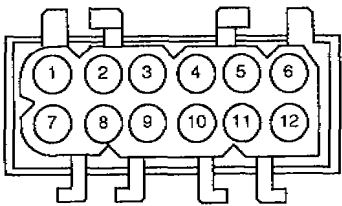

X33 SW

B210001.00

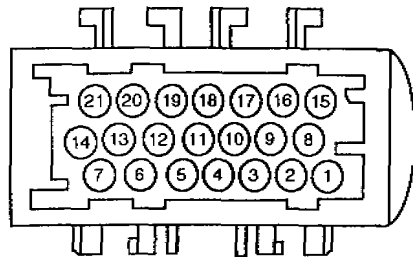

X36 SW



CONNECTOR VIEWS

B080001.01

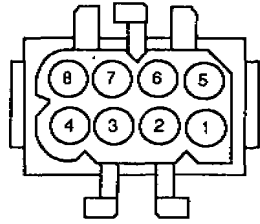

X69 WS

X72 WS

B080004.00

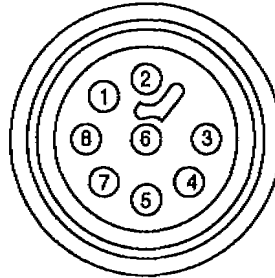

X71 SW

B080008.00

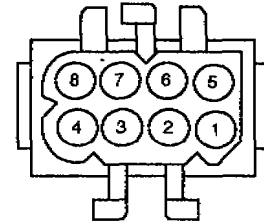

X74 OR

B080003.00

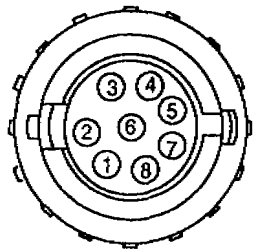

X70 SW

B080007.00

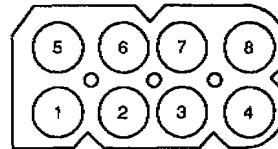

X73 SW

B060003.03

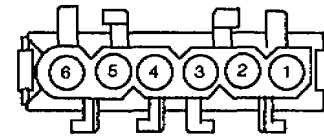

X75 OR



CONNECTOR VIEWS

B060017.00

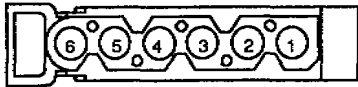

X76 SW

B040004.00



X78 SW

X79 SW

B030005.00

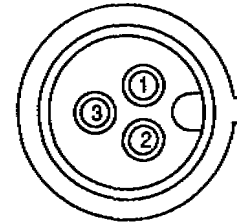

X81 OR

X86 OR

B050001.00

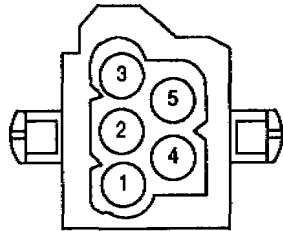

X77 GN

B040003.00

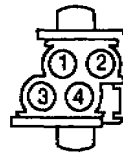

X80 GN

B030004.00

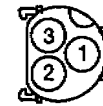

X82 SW

X85 SW



CONNECTOR VIEWS

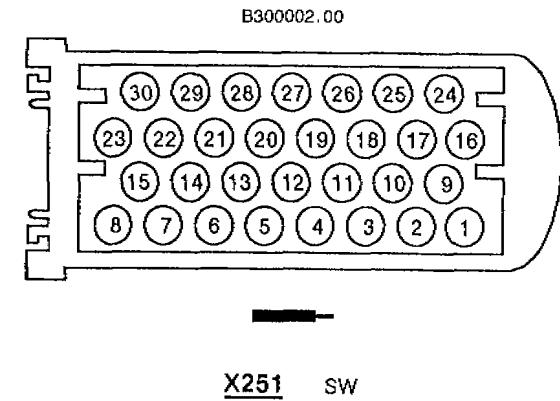
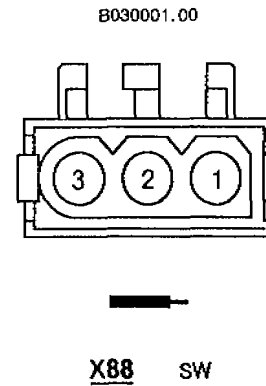
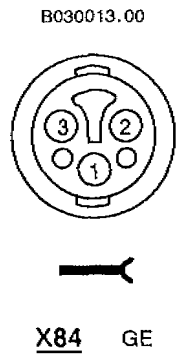
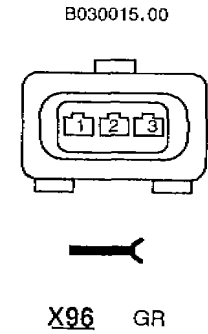
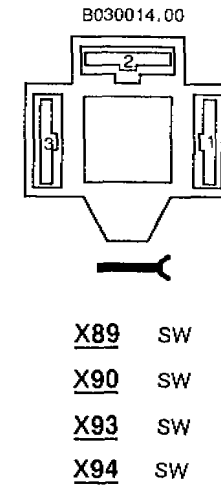
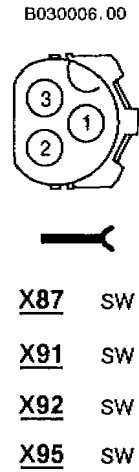
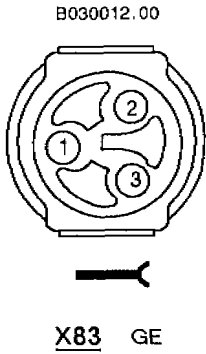



CONNECTOR VIEWS

B260002.01

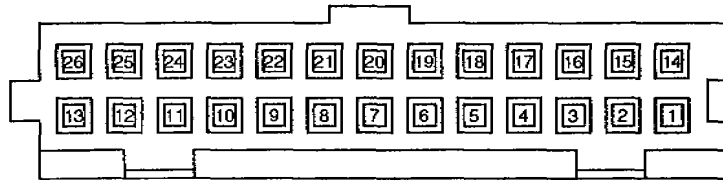

- | | | | |
|-------------|----|-------------|----|
| <u>X252</u> | GN | <u>X254</u> | WS |
| <u>X253</u> | GN | <u>X255</u> | GE |

B210001.00

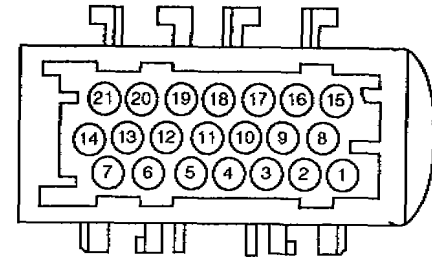

- | | |
|-------------|----|
| <u>X260</u> | SW |
|-------------|----|

B260001.00

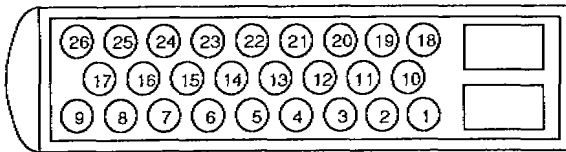

- | | |
|-------------|----|
| <u>X256</u> | SW |
| <u>X257</u> | SW |

B200001.00

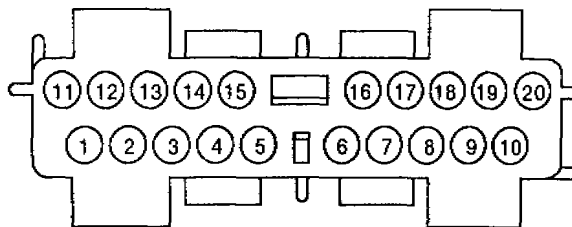

- | | |
|-------------|----|
| <u>X258</u> | SW |
| <u>X259</u> | WS |

B120005.00

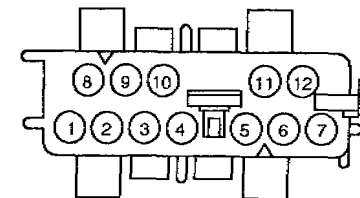

- | | |
|-------------|----|
| <u>X270</u> | SW |
|-------------|----|



CONNECTOR VIEWS

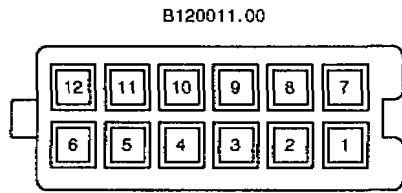

X271 GR

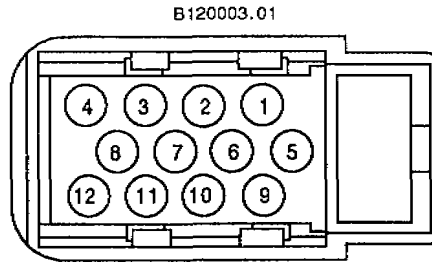

X273 SW

X274 SW

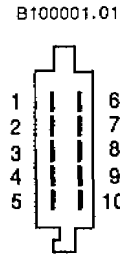

X277 SW

X278 SW

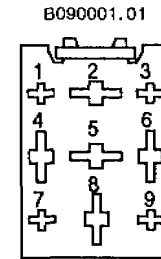

X291 SW

X293 WS

X292 WS

X294 WS

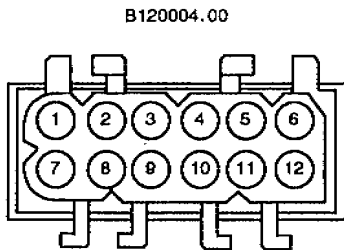

X272 SW

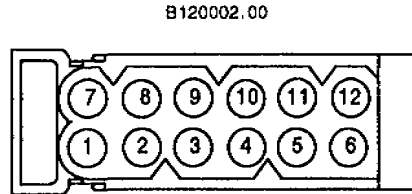

X275 WS

X279 WS

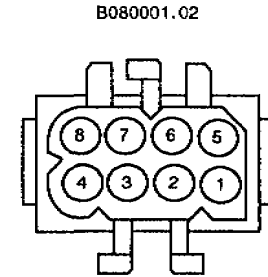

X295 SW

X298 SW

X299 SW

B060005.12

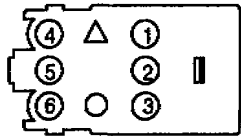

X311 SW

X312 SW

B060004.00

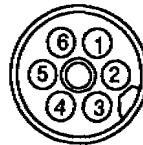

X318 SW

X319 SW

B060003.00

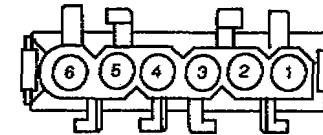

X322 SW

B060002.00

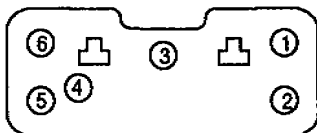

X316 WS

X317 SW

B060001.01

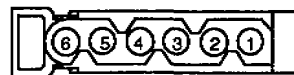

X321 WS

B050005.00

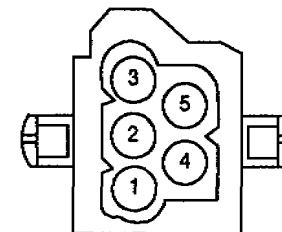

X331 GN



CONNECTOR VIEWS

B050006.00

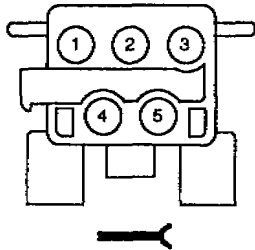

X332 SW

B040010.01

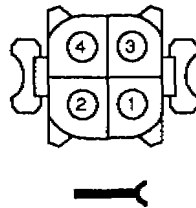

X334 WS

B040002.00

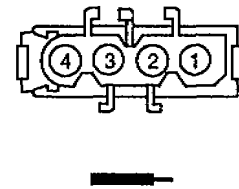

X336 WS

X337 WS

B040008.00

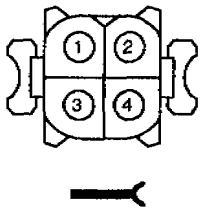

X333 SW

B040003.00

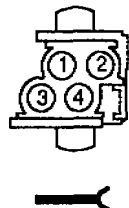

X335 GN

B030002.00

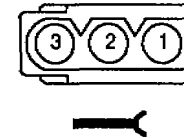

X351 SW

X352 SW

X353 SW

X354 SW



CONNECTOR VIEWS

B030003.00

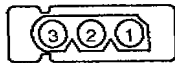

X355 WS

X356 WS

B0300010.00

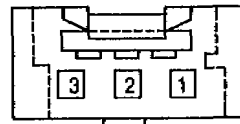

X360 NA

B030001.00

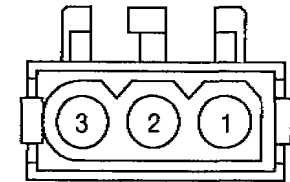

X400 SW

B030001.01

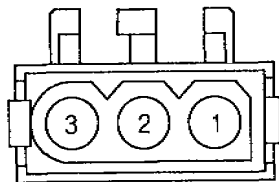

X358 SW

B260002.02

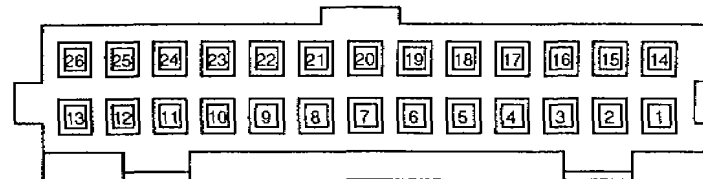

X501 GN

X502 WS



CONNECTOR VIEWS

B120006.00

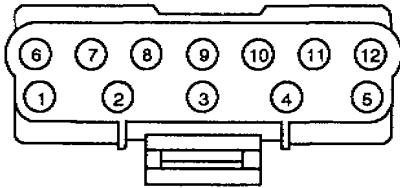

X503 SW

X504 SW

B120002.01

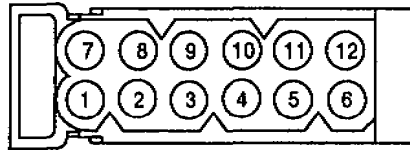

X506 SW

B080002.00

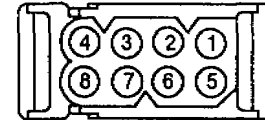

X511 SW

X512 SW

X513 SW

B120011.00

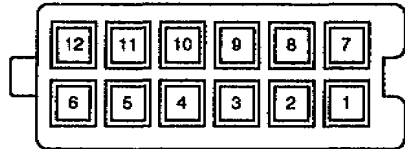

X505 GR

B090001.04

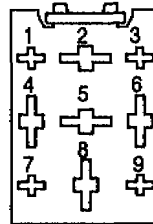

X509 SW

X510 SW

B060006.00

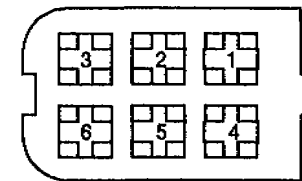

X514 SW



CONNECTOR VIEWS

B060003.02

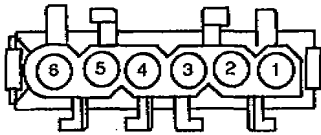

X515 WS

B0400004.00



X517 SW

X518 SW

B030001.02

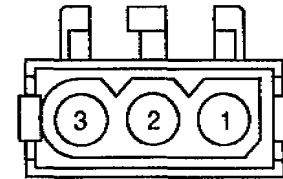

X520 WS

B050003.00

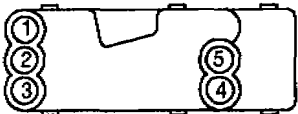

X516 SW

B040002.00

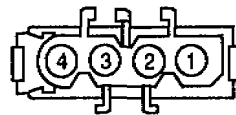

X519 WS

B060020.00

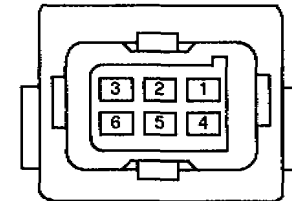

X521 SW



CONNECTOR VIEWS

B030003.01

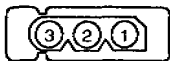

X522 WS

B080001.00

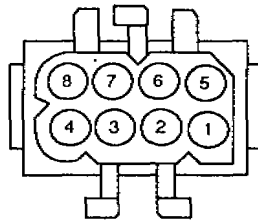

X528 SW

B120008.00

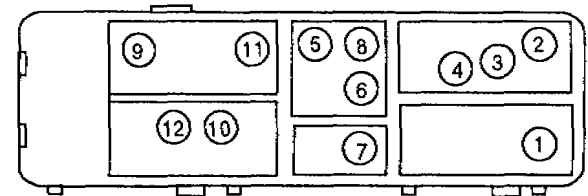

X603 SW

X604 SW

B0400002.00

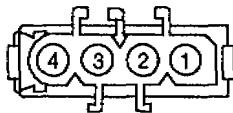

X524 SW

B260002.02

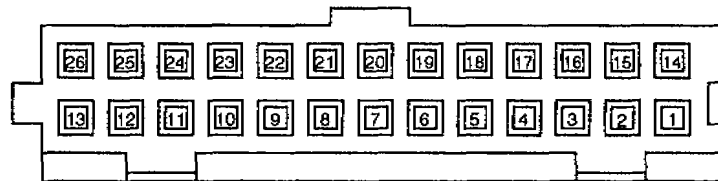

X601 WS X612 BL

X602 GE X613 BL

X610 WS X614 GE

X611 GN



CONNECTOR VIEWS

B120002.00

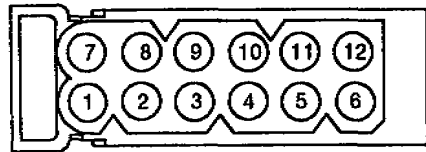

X605 SW

B120005.01

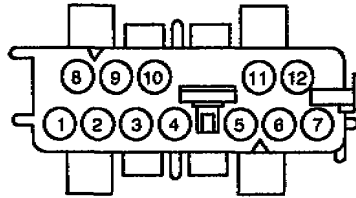

X607 SW

X609 SW

B090001.02

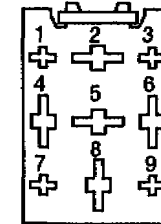

X620 WS

B120002.01

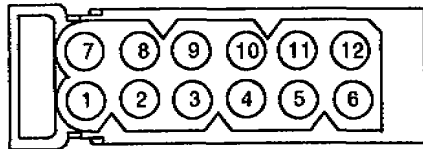

X606 WS

X619 WS

B120009.00

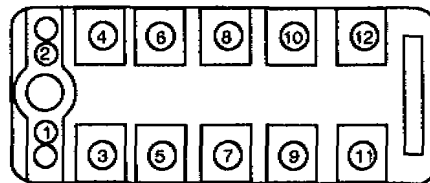

X608 SW

B100002.00

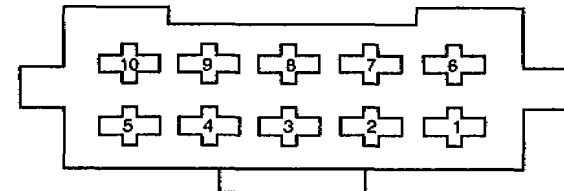

X621 SW

X622 SW



CONNECTOR VIEWS

B100005.00

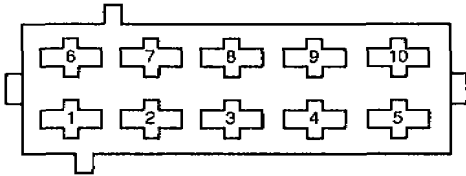

X623 SW

X624 SW

B080002.01

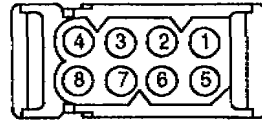

X626 SW

X627 SW

B080006.00

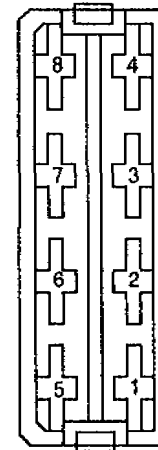

X629 NA

B060013.00

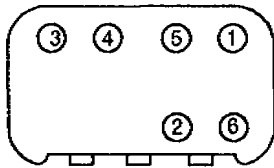

X625 SW

B030009.00

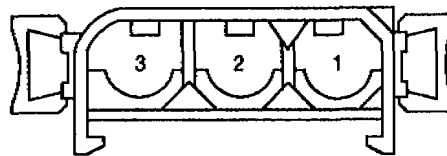

X628 SW

B130002.00

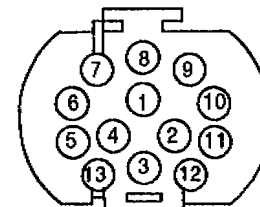

X630 SW



CONNECTOR VIEWS

B060005.00

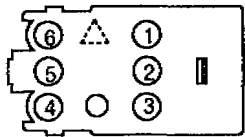

- X636 SW △
- X637 SW △
- X643 BL ▽

B050004.00

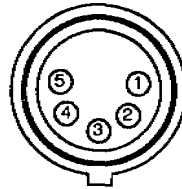

- X639 SW

B060016.00

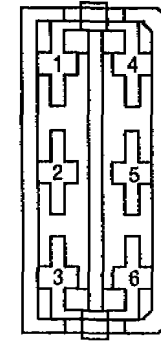

- X642 SW

B060009.00

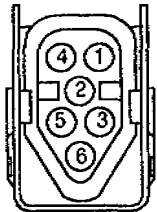

- X638 SW
- X641 SW
- X644 SW
- X646 SW
- X660 SW

B060019.00

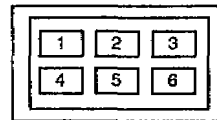

- X640 SW

B060008.00

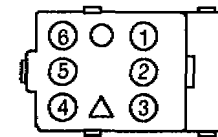

- X645 SW
- X647 SW



CONNECTOR VIEWS

B060005.01

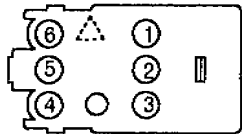

<u>X648</u>	SW	△	<u>X654</u>	WS	△
<u>X649</u>	WS	△	<u>X655</u>	BL	▽
<u>X650</u>	SW	△	<u>X656</u>	GN	△
<u>X651</u>	SW	△	<u>X657</u>	BR	▽
<u>X652</u>	BL	▽	<u>X658</u>	SW	△
<u>X653</u>	SW	△	<u>X659</u>	BL	▽

B050001.00

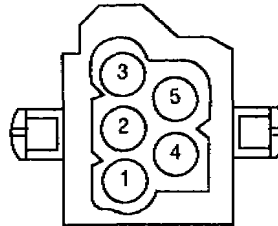

X671 GN

B0400004.01



X673 SW
X674 SW

B060010.01

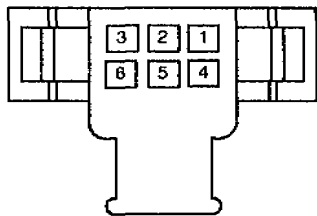

<u>X661</u>	SW		<u>X666</u>	SW
<u>X662</u>	SW		<u>X667</u>	SW
<u>X663</u>	SW		<u>X668</u>	SW
<u>X664</u>	SW		<u>X669</u>	SW
<u>X665</u>	SW		<u>X670</u>	SW

B040009.00

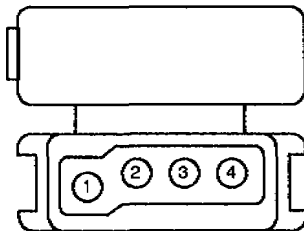

X672 SW

B030003.02



X680 SW
X683 SW
X693 SW



CONNECTOR VIEWS

B030001.03

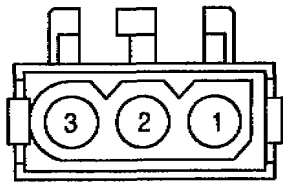

X681 WS

B030004.01

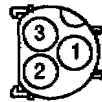

X684 SW

X685 SW

B030001.03

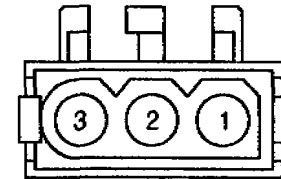

X692 SW

X695 SW

B030016.00

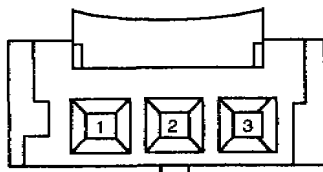

X682 NA

B030007.00

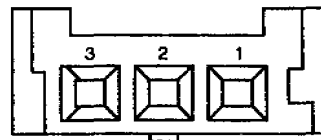

X686 BL

X687 BL

X688 BL

X689 BL

X690 BL

B030007.01

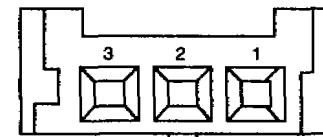

X694 NA



CONNECTOR VIEWS

B030009.00

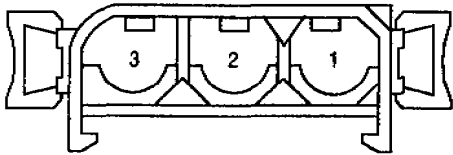

X696 SW

B030004.00



X928 SW

X929 SW

B030015.00

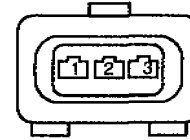

X1514 SW

X1521 SW

X1522 SW

X1525 SW

X1533 SW

X1612 GR

X1613 SW

X1614 GR

X1615 SW

X1622 SW

B060001.01



X907 WS

B550001.00

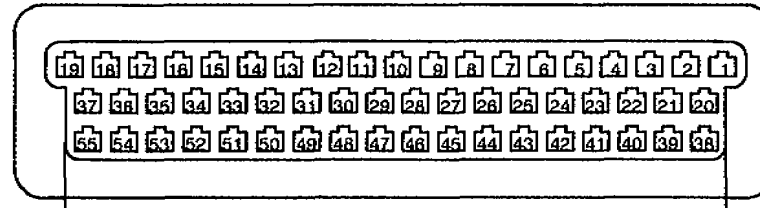

X1500 NA



CONNECTOR VIEWS

B090001.03

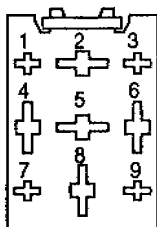

<u>X917</u>	RT	<u>X1605</u>	WS
<u>X941</u>	WS	<u>X1606</u>	WS
<u>X1515</u>	WS	<u>X1609</u>	WS
<u>X1516</u>	WS		

B050006.00



X1528 SW

B060014.00

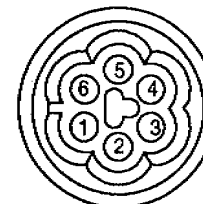

<u>X1536</u>	SW
<u>X1610</u>	SW
<u>X1611</u>	SW

B040006.00

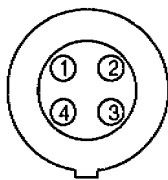

X1523 SW

B200003.00

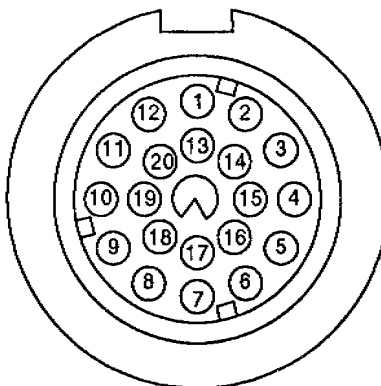

X1532 SW

B080002.02

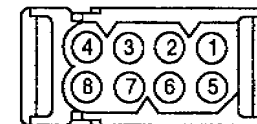

X1537 SW



CONNECTOR VIEWS

B350003.00

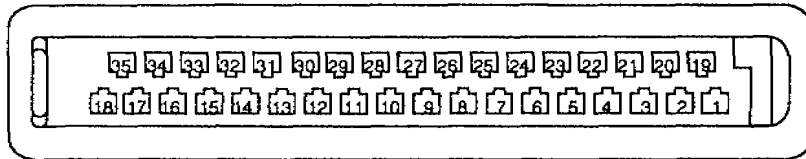

X1550 SW

B080009.00

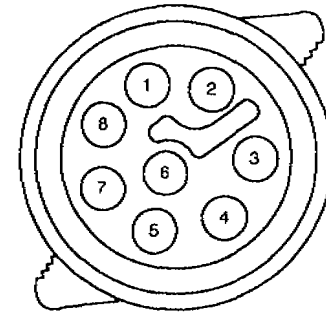

X1554 SW

B0400004.01

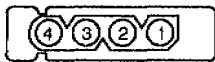

X1552 SW

B0400011.00

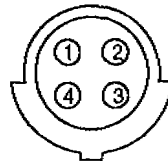

X1563 SW

X1564 SW

B07000.00

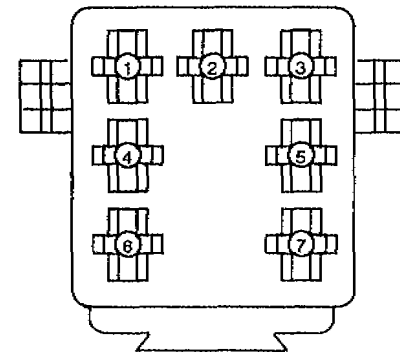

X1607 SW

X1608 SW



CONNECTOR VIEWS

B550002.01

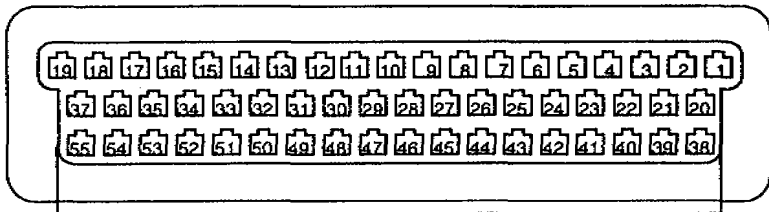

- X1600 NA
- X1601 NA
- X1602 NA

B120002.04

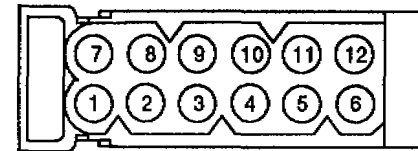

- X2001 SW

B080009.00

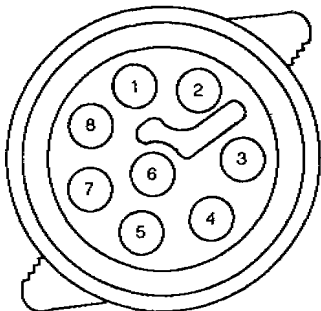

- X1618 SW
- X1619 SW

B350004.00

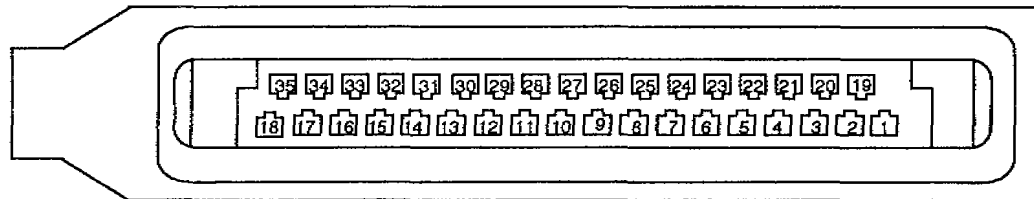

- X2000 NA



CONNECTOR VIEWS

B060005.17

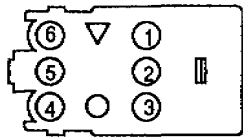

X2003 BL

B080005.00

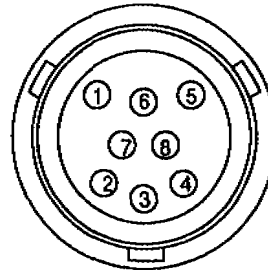

X2005 SW

B120009.01

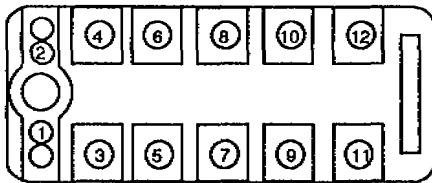

X2004 SW